

**2019
HARLEY-DAVIDSON®
GENUINE MOTOR
PARTS & ACCESSORIES**



MODEL INFORMATION

YEAR:	MODEL:	ALPHA CODE:	FAMILY:	COLOR:	ENGINE TYPE:	DISPLACEMENT:
-------	--------	-------------	---------	--------	--------------	---------------

HARLEY-DAVIDSON MODELS – 1984 to 2019 (excluding FX and FXR models)

STREET™ FAMILY

HARLEY-DAVIDSON STREET® 500	XG500	'15-CURRENT
HARLEY-DAVIDSON STREET 750	XG750	'15-CURRENT
STREET ROD®	XG750A	'17-CURRENT

VRSC™/V-ROD® FAMILY

V-ROD	VRSCA	'02-'06
V-ROD	VRSCAW	'07-'10
V-ROD	VRSCB	'04-'05
STREET ROD™	VRSCR	'06-'07
CVO™ V-ROD	VRSCSE	'05-'06
CVO DESTROYER™	VRSCX	'07
NIGHT ROD	VRSCD	'06-'08
NIGHT ROD SPECIAL	VRSCDX	'07-'17
V-ROD MUSCLE®	VRSCF	'09-'17

SPORTSTER® FAMILY

SPORTSTER 1000	XLH	'84-'85
SPORTSTER 883	XLH883/XL883	'86-'08
SPORTSTER 883 CUSTOM	XLH883C/XL883C	'99-'09
SPORTSTER 883 DELUXE	XLH883 DLX	'88-'95
SPORTSTER 883 HUGGER™	XLH883 HUG	'88-'03
SPORTSTER 1100	XLH1100	'86-'87
SPORTSTER 1200	XLH1200	'88-'03
SPORTSTER 1200 CUSTOM	XLH1200C/XL1200C	'96-CURRENT
SPORTSTER 1200 SPORT	XL1200S	'96-'03
SPORTSTER 883 LOW	XL883L	'05-'10
SPORTSTER SUPERLOW®	XL883L	'11-CURRENT
SPORTSTER 883 IRON™	XL883N	'09-CURRENT
SPORTSTER 883R	XL883R	'02-'03, '05-'07
SPORTSTER ROADSTER®	XL1200CX	'16-CURRENT
SPORTSTER 1200 LOW	XL1200L	'06-'11
SPORTSTER 1200 NIGHTSTER™	XL1200N	'07-'12
SPORTSTER IRON 1200™	XL1200NS	'18-CURRENT
SPORTSTER 1200 ROADSTER	XL1200R	'04-'08
SPORTSTER SUPERLOW 1200T	XL1200T	'14-'17
SPORTSTER SEVENTY-TWO®	XL1200V	'12-'16
SPORTSTER FORTY-EIGHT®	XL1200X	'10-CURRENT
SPORTSTER FORTY-EIGHT® SPECIAL	XL1200XS	'18-CURRENT
50TH ANNIVERSARY SPORTSTER	XL50	'07
ROADSTER	XLS	'84-'85
XLX-61	XLX	'84-'86
XR-1000	XR-1000	'84-'85
XR1200™	XR1200	'08-'10
XR1200X™	XR1200X	'11-'13

DYNA® FAMILY

SWITCHBACK™	FLD	'12-'16
DYNA SUPER GLIDE®	FXD/I	'95-'10
STREET BOB®	FXDB/I	'06-'17
DYNA SUPER GLIDE CUSTOM	FXDC/I	'05-'14
FAT BOB®	FXDF	'08-'17
CVO FAT BOB	FXDFSE	'09-'10
DYNA LOW RIDER	FXDL/I	'93-'09, '14-'17
DYNA LOW RIDER S	FXDLS	'16-'17
DYNA CONVERTIBLE	FXDS CONV	'94-'00
SCREAMIN' EAGLE® DYNA	FXDSE	'07-'08
DYNA WIDE GLIDE®	FXDWG/I	'93-'08, '10-'17
CVO DYNA WIDE GLIDE	FXDWG2/3	'01-'02
DYNA SUPER GLIDE SPORT	FXDX/I	'99-'05

SOFTAIL® FAMILY – MILWAUKEE-EIGHT®

SOFTAIL® DELUXE	FLDE	'18-CURRENT
FAT BOY®	FLFB/S	'18-CURRENT
HERITAGE SOFTAIL® CLASSIC	FLHC/S	'18-CURRENT
SOFTAIL SLIM®	FLSL	'18-CURRENT
SPORT GLIDE™	FLSB	'18-CURRENT
STREET BOB®	FXBB	'18-CURRENT
BREAKOUT®	FXBR/S	'18-CURRENT
FXDR 114	FXDRS	'19
FAT BOB®	FXFB/S	'18-CURRENT
LOW RIDER®	FXLR	'18-CURRENT

SOFTAIL® FAMILY – EVOLUTION® 1340/TWIN CAM

SOFTAIL SLIM®	FLS	'12-'17
SOFTAIL SLIM S	FLSS	'16-'17
HERITAGE SOFTAIL®	FLST/I	'86-'90, '06
HERITAGE SOFTAIL CLASSIC	FLSTC/I	'88-'17
CROSS BONES®	FLSTSB	'08-'11
SOFTAIL SPRINGER™ CLASSIC	FLSTSC/I	'05-'07
CVO™ SOFTAIL CONVERTIBLE	FLSTSE	'10-'12
FAT BOY®	FLSTF/I	'90-'17
FAT BOY LO/SPECIAL	FLSTFB	'10-'16
FAT BOY S	FLSTFBS	'16-'17
CVO FAT BOY	FLSTFSE	'05-'06
HERITAGE SOFTAIL SPECIAL/NOSTALGA	FLSTN	'93-'96
SOFTAIL DELUXE	FLSTM/I	'05-'17
CVO DELUXE	FLSTNSE	'14-'17
HERITAGE SPRINGER®	FLSTS/I	'97-'03
ROCKER™	FXCW	'08-'09
ROCKER C	FXCWC	'08-'11
BLACKLINE®	FXS	'11-'13
BREAKOUT®	FXSB	'13-'17
CVO BREAKOUT	FXSBSE	'13-'14
CVO PRO STREET BREAKOUT	FXSE	'16-'17
SOFTAIL /SOFTAIL STANDARD	FXST/I	'84-'90, '99-'15
NIGHT TRAIN™	FXSTB/I	'98-'09
SOFTAIL CUSTOM	FXSTC	'86-'99, '07-'10
SOFTAIL DEUCE™	FXSTD/I	'00-'07
CVO DEUCE	FXSTDSE	'03-'04
SPRINGER SOFTAIL	FXSTS/I	'88-'06
BAD BOY	FXSTSB	'95-'97
CVO SPRINGER SOFTAIL	FXSTSSE	'07-'09

TOURING FAMILY

ROAD KING®	FLHR/I	'94-CURRENT
ROAD KING CLASSIC	FLHRC/I	'98-CURRENT
ROAD KING CUSTOM	FLHRS/I	'04-'07
ROAD KING SPECIAL	FLHRXS	'17-CURRENT
CVO ROAD KING	FLHRSE	'02-'03, '07-'08, '13-'14
ELECTRA GLIDE®	FLH	'84-'85
ELECTRA GLIDE SPECIAL	FLHX	'84-'85
ELECTRA GLIDE SPORT	FLHS	'84, '87-'93
ELECTRA GLIDE STANDARD	FLHT/I	'86-'87, '95-'09
ELECTRA GLIDE CLASSIC	FLHTC/I	'84-'13
CVO ELECTRA GLIDE	FLHTCSE	'04-'05
ELECTRA GLIDE ULTRA CLASSIC®	FLHTCU/I	'89-CURRENT
ELECTRA GLIDE ULTRA CLASSIC TWIN-COOLED™	FLHTCU TC	'14-CURRENT
ELECTRA GLIDE ULTRA CLASSIC LOW	FLHTCUL	'15-'16
ELECTRA GLIDE ULTRA CLASSIC LOW TWIN-COOLED	FLHTCUL TC	'15-'16
CVO ELECTRA GLIDE ULTRA CLASSIC	FLHTCUSE	'06-'13
STREET GLIDE®	FLHX	'06-CURRENT
STREET GLIDE SPECIAL	FLHXS	'14-CURRENT
CVO STREET GLIDE	FLHXSE	'10-'12, '15-CURRENT
ULTRA LIMITED	FLHTK	'10-CURRENT
ULTRA LIMITED LOW	FLHTKL	'15-CURRENT
CVO LIMITED	FLHTKSE	'14-CURRENT
TOUR GLIDE™ CLASSIC	FLTC	'84-'91
ULTRA CLASSIC TOUR GLIDE	FLTCU/I	'89-'96
ROAD GLIDE®	FLTR/I, FLTRX	'98-'09, '15-CURRENT
CVO ROAD GLIDE	FLTRSE	'00-'01, '09
ROAD GLIDE ULTRA	FLTRU	'11-'13, '16-CURRENT
CVO ROAD GLIDE ULTRA	FLTRUSE	'11, '15-'16
ROAD GLIDE CUSTOM	FLTRX	'10-'13
ROAD GLIDE SPECIAL	FLTRXS	'15-CURRENT
CVO ROAD GLIDE CUSTOM	FLTRXSE	'12-'13, '18

TRIKE FAMILY

TRI GLIDE® ULTRA CLASSIC	FLHTCUTG	'09-CURRENT
STREET GLIDE TRIKE	FLHXXX	'10-'11
FREEWHEELER®	FLRT	'15-CURRENT

STREET™	4
WINDSHIELDS	10
SEATING	11
BACKRESTS & RACKS	13
SADDLEBAGS & LUGGAGE	14
ENGINE GUARDS/PROTECTION	15
HANDLEBARS	16
HAND & FOOT CONTROLS	17
MIRRORS	20
ENGINE TRIM	21
WHEELS & AXLE TRIM	24
SCREAMIN' EAGLE® PERFORMANCE	26
V-ROD®	28
WINDSHIELDS	30
SEATING	31
BACKRESTS & RACKS	32
CHASSIS TRIM	34
BRAKES	34
HAND & FOOT CONTROLS	36
ENGINE GUARDS	38
ENGINE TRIM	39
SPORTSTER®	40
CAFÉ CUSTOM	54
WINDSHIELDS	60
SEATING	66
BACKRESTS & RACKS	74
SADDLEBAGS	80
SUSPENSION	86
HAND & FOOT CONTROLS	89
ENGINE GUARDS & PASSENGER PEGS	93
CHASSIS TRIM – FRONT END	94
CHASSIS TRIM – REAR END	98
CHASSIS TRIM – BODYWORK	102
DYNA®	104
WINDSHIELDS	106
SEATING	112
BACKRESTS, RACKS & LUGGAGE	119
SUSPENSION	128
FOOT CONTROLS	129
ENGINE GUARDS & HIGHWAY PEGS	134
CHASSIS TRIM – FRONT END	135
CHASSIS TRIM – REAR END	140
CHASSIS & TANK TRIM	145
MILWAUKEE-EIGHT® SOFTAIL®	146
WINDSHIELDS	166
SEATING	172
BACKRESTS & RACKS	184
SADDLEBAGS	192
LUGGAGE	197
HAND & FOOT CONTROLS	198
ENGINE GUARDS	203
CHASSIS TRIM – FRONT END	204
CHASSIS TRIM – BRAKES	207
CHASSIS TRIM – REAR END	212

TWIN CAM SOFTAIL®	214
WINDSHIELDS	216
SEATING	223
BACKRESTS & RACKS	234
SADDLEBAGS	214
FOOT CONTROLS	253
ENGINE GUARDS & HIGHWAY PEGS	259
CHASSIS TRIM – FRONT END	261
CHASSIS TRIM – REAR END	271
CHASSIS TRIM – ENGINE & FENDERS	276
TOURING & TRIKE	280
WINDSHIELDS	304
FAIRING LOWERS & ACCESSORIES	320
COOLFLOW™ FAN	322
SEATING	344
BACKRESTS & RACKS	446
TOUR-PAK® & ACCESSORIES	355
SADDLEBAGS & ACCESSORIES	362
LUGGAGE ACCESSORIES	368
FOOT CONTROLS	374
ENGINE GUARDS & CENTER STANDS	384
SUSPENSION & FRONT END	386
CHASSIS TRIM – FAIRING & CONSOLE	402
CHASSIS TRIM – REAR END	414
CHASSIS TRIM – REAR LIGHTING	419
AUXILIARY POWER & CHARGING	425
PAINT PROTECTION	429
SCREAMIN' EAGLE®	430
STREET TUNER	438
MILWAUKEE-EIGHT® POWERTRAIN	440
TWIN-CAM POWERTRAIN	466
SPORTSTER® POWERTRAIN	496
AIR FILTERS & SPARK PLUGS	508
CRATE ENGINES & TRANSMISSIONS	511
ENGINE TRIM	522
COLLECTIONS	524
MILWAUKEE-EIGHT™ ACCESSORIES	547
TWIN CAM ACCESSORIES	550
AIR CLEANER COVERS	562
HARDWARE & HARDWARE COVERS	568
CONTROLS	574
HAND & FOOT CONTROL COLLECTIONS	576
FOOTPEGS & FOOTBOARDS	609
HIGHWAY PEGS & FOOTPEG HARDWARE	614
MIRRORS	616
HAND CONTROLS & LEVERS	622
HANDLEBARS	630
HANDLEBAR RISERS & CABLES	649
AUDIO & GAUGES	654
BOOM!™ AUDIO – TOURING BIKES	656
BOOM! AUDIO – STAGE I	658
BOOM! AUDIO – STAGE II	664
BOOM! AUDIO – PRE-RUSHMORE	673
HEADSETS & ANTENNA	683
ANTENNA SYSTEMS	688
PHONE MOUNTS & ACCESSORIES	690
BOOM! AUDIO – CRUISER BIKES	691
GPS NAVIGATION & SIRIUSXM™	692
AUXILIARY POWER & CHARGING	694
GAUGES	696
FUEL GAUGES, CAPS & MEDALLIONS	698
CLOCKS & AIR TEMP	705

LIGHTING	706
SPECTRA GLO™ & LED CUSTOM LIGHTING	708
HEADLAMPS & AUXILIARY LIGHTING	713
HEADLAMP TRIM	725
TURN SIGNALS	732
TAIL & BRAKE LAMPS	744
LICENSE MOUNTS & ACCESSORIES	747
HORNS & HORN COVERS	749
WHEELS	752
CUSTOM WHEELS	755
SPROCKETS	764
BRAKE ROTORS	765
WHEEL ACCESSORIES	767
LUGGAGE	768
TOURING LUGGAGE & ACCESSORIES	770
WINDSHIELD & FAIRING BAGS	776
TIE-DOWNS & ACCESSORIES	778
FLAGS	780
COLOR SHOP	782
CUSTOM PAINT SETS	784
COLOR-MATCHED ACCESSORIES	788
PAINTS	803
MEDALLIONS & DECALS	804
GARAGE	806
SURFACE CARE PRODUCTS	810
MOTORCYCLE COVERS	817
GARAGE STORAGE	822
MOTORCYCLE LIFTS & TIE-DOWNS	823
SECURITY LOCKS & SYSTEMS	825
OIL	832
OIL CHANGE ACCESSORIES	834
LUBES AND SEALENTS	838
BATTERY CHARGERS	840
BATTERIES	843
TOOLS	844
AIR FILTERS	846
SPARK PLUGS	848
BRAKE PADS	849
TIRE GAUGES & AIR PUMPS	850
INDEX	
ALPHABETIC INDEX	856
PAGE NUMBER/PART NUMBER INDEX	875
WARRANTY INFORMATION	IBC

FREE [ER]

TO EXPRESS YOURSELF

No two rides should ever be alike. And with thousands of Harley-Davidson® parts and accessories to work with, no matter what your style or vision, you're free to create that one-off custom motorcycle of your dreams. All it takes to get started are Harley-Davidson® Genuine Motor Parts and Accessories and the drive to live more free.



**ALL FOR FREEDOM
FREEDOM FOR ALL™**



*Handlebar height is regulated in many locations. Check local laws before installation.



STREET ROD®

HARLEY-DAVIDSON STREET® | XG750A | RUGGED GOLD DENIM

This is what happens when rocket scientists become motorcycle engineers. With Stage I power that'll get your adrenaline pumping and an exhaust note from the slip-on mufflers that just begs to be heard, this Street Rod® motorcycle is ready for lift-off when you are.



Screamin' Eagle® Performance Air Cleaner Kitp26



Screamin' Eagle® Slip-On Muffler..... p27



Diamond Black Hand Grips/Bar End Mirrors..... p20



Reach® Seatp 12



STREET™ 500

HARLEY-DAVIDSON STREET® | XG500 | TWISTED CHERRY

Staring may not be polite, but it should definitely be expected. With its black-as-night accents, Café Solo Seat and 17" custom wheel, this Street™ 500 motorcycle will have you accepting the fact that all those looks you're getting are absolutely not for you.



Café Solo Seatp11



Dominion™ Hand Grips (Black) p 17



17" Typhoon Custom Front Wheel (Black)p25



Harley-Davidson Motor Company — Air Cleaner Trimp21



STREET™ 750

HARLEY-DAVIDSON STREET® | XG750 | RAWHIDE

The fastest way from point A to point B is a blisteringly fast straight line. With 750cc of street-eating power, blacked-out accents with knurled surfaces for dramatic contrast and 2-1 exhaust, this Street™ 750 motorcycle is ready to blaze a path from any point you choose.



Screamin' Eagle® Nightstick 2-1 Exhaust..... p 27



Screamin' Eagle® Air Cleaner Trim..... p 26



Diamond Collection Footpeg/Shifter Pegp20



Dark Custom™ Medallion p 23

10 STREET™

Windshields & LED Headlamps

A. QUICK-RELEASE SUPER SPORT WINDSHIELD

Reduces the pounding of wind and shower of bugs but keeps the wind-in-the-hair feeling. Ideal for a cool morning ride, the sleek profile of the Super Sport Windshield hugs the front headlamp for a sporty look. The windshield mounts to the fork tubes with elegant die-cast lever locking clamps, so the windshield does not require any "leave-behind" docking hardware. You get quick on-and-off convenience and a clean, custom look. No tools are required and the kit includes everything needed to install the windshield.

57400192 Light Smoke. **\$319.95**
Fits '15-later XG models (except XG750A). Installation requires removal of Original Equipment headlamp visor. Models equipped with a front mounted license plate require separate purchase of License Plate Bracket P/N 67900227. Windshield dimensions: Overall height 25.0"; width – 20.1".

B. DAYMAKER® LED HEADLAMPS

Cut through the night. Harley-Davidson® LED Lamps are brighter and whiter in color and provide a superior light pattern over standard incandescent lamps. Compared to the yellow light of a traditional halogen bulb, the LED lamp produces a "Daylight Color Impression" that appears more natural to the user. Headlamps feature horizontal "D-shaped" lenses that focus light into a pool in front of the motorcycle and separate high beam and low beam projector lenses that provide a focused beam of light ahead. Lamps are available in your choice of brilliant chrome or gloss black background to match your styling direction. The solid-state LEDs are designed for long life and the shock- and vibration-resistant lamp assembly mounts into existing light housings. Installation is quick and easy and the plug-in lamps connect to the factory headlamp wiring. The LED lamps are DOT and ECE compliant.

Fits '15-later XG models.

67700144A 5-3/4" Headlamp – Chrome. **\$399.95**
67700145A 5-3/4" Headlamp – Black. **\$399.95**



A. QUICK-RELEASE SUPER SPORT WINDSHIELD



B. DAYMAKER LED HEADLAMPS – CHROME



B. DAYMAKER LED HEADLAMPS – GLOSS BLACK

Notice: The prices appearing in this catalog are the manufacturer's suggested retail prices. Actual retail prices may vary.



C. CAFÉ SOLO SEAT

C. CAFÉ SOLO SEAT

There's something about the placement of the rider that makes the Café Solo Seat special. The one-up design and the high back pad hold the rider in place and provide a direct connection to the bike. You sit "in" the bike and your hands and feet reach naturally to the controls. The low-slung pad, narrow nose and the tapered tail enhance the bike's sporting profile and pays homage to the heritage of the iconic Café Racer style.

52000168 **\$219.95**

Fits '15-later XG models (except XG750A). Seat width 11.25".

D. REACH® SEAT

Designed specifically for riders requiring a close to the bar riding position, this Reach® Seat is shaped to place the rider in a comfortable and confident relationship to the hand and foot controls. The seat moves the rider approximately 1.5" lower and 1.25" forward and the 1.25" slimmer front profile brings the legs closer together for an easier reach to the ground at a stop. The Reach Seat features a stepped profile that keeps the rider from sliding back during acceleration.

52000123 **\$214.95**

Fits '15-later XG models (except XG750A). Seat width 10.25"; passenger pillion width 6.75".



D. REACH SEAT

E. TALLBOY® SEAT

The correct riding position can help a tall rider sit comfortably on the bike, and avoid leg cramps and back strain during a long day in the saddle. For riders with a longer inseam, a Tallboy® Seat will put you on the road to fatigue-free riding. Designed to move the rider 1.25" up and 2.5" back from the stock seating position, a Tallboy Seat can eliminate the "knees-high" riding position and effectively places the body for a natural arm and leg reach to the controls.

52000124 **\$214.95**

Fits '15-later XG models (except XG750A). Seat width 10.5"; passenger pillion width 7.5".



E. TALLBOY SEAT

Notice: The prices appearing in this catalog are the manufacturer's suggested retail prices. Actual retail prices may vary.

12 STREET™

Seating

A. REACH® RIDER SEAT – STREET ROD® MODEL

Fit and style in one. Styled to match the Original Equipment passenger pillion, this low-profile seat provides a slammed, sporting custom look to the Street Rod® model. And because this Reach® Rider Seat drops the rider deeper into the bike, it minimizes the leg stretch to the ground at a stop or while parking the bike.

Measurements as compared to other seating options:

- Stock Street Rod model seat – 1.5" lower.

52000375 **\$199.95**
Fits '17-later XG750A models. Seat width 10.75"

B. CIRCULATOR SEAT AND BACKREST PADS

Keep comfortable on your next long ride. These breathable Circulator Seat Pads feature 3D construction that promotes air movement and reduces heat build-up where the rider's body touches the seat or backrest. Designed to keep the rider cool by reducing the perspiration build-up between you and the seating surface, the Circulator Pad can be installed and removed in seconds for easy cleaning.

Fits '15-later XG models.

51074-10 Medium Seat Pad. **\$84.95**

51078-10 Passenger Pillion Pad. **\$69.95**

C. TANK KNEE PAD KIT

These self-adhesive rubber knee pads provide a touch of old school style. The rich black rubber pads feature tapered ribs and a raised Bar & Shield logo to protect the surfaces where your legs contact the tank. The compact pads measure 7.0" by 2.75", and are flexible enough to fit many tank profiles. Sold in matched pairs.

57300065 **\$39.95**

Fits fuel tanks on many Street™, Sportster®, Dyna® and Softail® models. May cover a portion of fuel tank graphics. Check appearance before adhering to tank.

D. BUNGEE BARS – STREET ROD MODEL

Secure soft luggage or spare helmet to the passenger pillion. Bungee Bar System provides a solid anchor point for cords or cargo net hooks and protects the fender finish from damage. Black scratch-resistant zinc-plated steel bars feature formed detents on each side to prevent sliding of bungee hooks. Kit includes left and right bars shockmount tiedowns and all required mounting hardware.

50300123 **\$104.95**

Fits '17-later XG750A models.



A. REACH RIDER SEAT – STREET ROD MODEL



B. CIRCULATOR SEAT PAD (RIDER SHOWN)



C. TANK KNEE PAD KIT



D. BUNGEE BARS – STREET ROD MODEL

Notice: The prices appearing in this catalog are the manufacturer's suggested retail prices. Actual retail prices may vary.



E. H-D DETACHABLES TWO-UP LUGGAGE RACK



E. H-D® DETACHABLES™ TWO-UP LUGGAGE RACK*

Smooth sweeping curves and a rich finish defines the look of this Luggage Rack. Available in chrome or gloss black, this sleek and functional rack is an elegant solution for carrying your luggage for a day at the office or for a ride across the country. The rack can be installed or removed from the Docking Hardware in seconds for a truly versatile ride and it can be equipped with the matching Backrest Upright and Pad for added passenger comfort.

Fits '15-later XG models (except XG750A). Requires separate purchase of Docking Hardware Kit P/N 52300285.

50300071	Chrome.	\$199.95
50300091	Gloss Black.	\$199.95

F. SISSY BAR UPRIGHT

A sissy bar upright and passenger backrest pad are the starting point to build a complete touring machine. The backrest pad provides long-range comfort and support and adds a feeling of control and confidence for the passenger. This unique upright attaches directly to the H-D® Detachables™ Two-Up Luggage Rack for a clean, custom look and the available Backrest Pad P/N 52300281 complements Original Equipment and accessory seats. Kit includes upright and mounting hardware.

Fits '15-later XG models (except XG750A). Requires separate purchase of H-D Detachables Luggage Rack P/N 50300071 or 50300091 and Docking Hardware Kit P/N 52300285.

52300283	Chrome.	\$79.95
52300307	Gloss Black.	\$79.95

G. COMPACT PASSENGER BACKREST PAD

This backrest pad sports French seams and a smooth, clean finish that looks great with any smooth surface seat.

52300281 **\$49.95**
Fits '15-later XG models equipped with Sissy Bar Upright P/N 52300283 or 52300307.

H. DOCKING HARDWARE

Required for installation of detachable luggage rack on Harley-Davidson Street® models.

52300285 **\$39.95**
Fits '15-later XG models (except XG750A).



F. SISSY BAR UPRIGHT (SHOWN WITH LUGGAGE RACK AND BACKREST PAD)



G. COMPACT PASSENGER BACKREST PAD



H. DOCKING HARDWARE



***WARNING:** Do not use this rack as a seat. Do not exceed the fender rack weight capacity. Using as seat or exceeding this capacity could cause handling problems which could result in loss of control and death or serious injury.

Notice: The prices appearing in this catalog are the manufacturer's suggested retail prices. Actual retail prices may vary.

14 STREET™

Luggage

A. THROW-OVER SADDLEBAGS

Ballistic Nylon throw over saddlebags offer convenient storage and can be easily removed for transport. 3M™ Scotchlite™ reflective piping adds additional visibility and top mount zippers offer quick easy access to items. Center yoke allows for two-up riding and can double as a shoulder strap when its time to carry the bags. Quick mount system allows rider to attach and detach saddlebags quickly. Kit includes saddlebag supports.

90200906 **\$359.95**

Fits '15-later XG models (except XG750A).

B. PHONE CARRIER MOUNT

Designed to place a smartphone or music device close at hand, this ball-tipped mount is center-mounted to the handlebar clamp and provides a direct view just below the speedometer. When combined with the Universal Phone Carrier P/N 76000549 or Water Resistant Carriers P/N 76000576, 76000605 or 76000670, the ball-shaped mount provides a wide range of adjustability for the ideal viewing angle.

76000758 **\$29.95**

Fits '15-later XG models. Requires the separate purchase of an H-D™ Smart Phone Carrier.

C. MUSIC PLAYER TANK POUCH

This portable music system pouch is designed for motorcycle use. The neoprene jacket offers hard-core protection for your portable music device, while the built-in magnets hold the pouch securely to the fuel tank. The clear play-through window permits touch-screen control and the anti-skid interior allows the pouch to accommodate players of various sizes. The clamshell design makes inserting your player into the pouch quick and easy and the double zipper allows for headphone and output cables to exit the pouch at any point on top, bottom or one side of the pouch. Works well with many MP3 and other personal music players, but should not be used with hard-disk memory players. Window measurement: 2.25" W x 4.0" H.

76000193 **\$44.95**

Fits models with steel fuel tanks or airbox covers.



A. THROW-OVER SADDLEBAGS



B. PHONE CARRIER MOUNT



C. MUSIC PLAYER TANK POUCH

Notice: The prices appearing in this catalog are the manufacturer's suggested retail prices. Actual retail prices may vary.

D. ENGINE GUARD*

The unique soft curve shape adds style to function. The two-piece Engine Guard is designed to complement the lines of the Harley-Davidson Street® motorcycle and the choice of finishes adds the perfect custom touch. Add your choice of Engine Guard Mounted Highway Pegs (sold separately) to change your foot position on a long ride.

Fits '15-later XG models.

49000047B	Gloss Black.	\$214.95
49000015B	Chrome.	\$209.95

E. UNIVERSAL MOUNT HELMET LOCK

To limit grab-and-run theft, just unlock the hinged clasp, hang your helmet by its strap and relock with the included key. Your helmet is held securely in place. In addition, hanging your helmet reduces the risk of impact damage if the helmet slipped off the seat or the handlebar. Designed to be installed to .875" to 1.25" diameter tubing engine guards, saddlebag guards and frame tubes, the Helmet Lock is secured to the bike with tamper-proof hardware that cannot be easily removed. Note: Do not use lock when vehicle is in motion. Helmet Lock should only be used when motorcycle is parked and locked. Duplicate keys are not available.

45732-86 **\$27.95**

Fits all models. VRSC™, '15-later XG and '04-later XL and XR models require installation of engine guard.

F. CENTER STAND

Lifting your bike upright and off the side stand is ideal for cleaning and servicing and reduces the space required for parking – handy where space is at a premium in a crowded garage, a small parking spot or at a ride-in bike show. The robust gloss black painted center stand attaches directly to the frame and does not reduce the lean angle. Kit includes gloss black center stand, mounting brackets and all necessary installation hardware.

92900014 **\$199.95**

Fits '15-later XG models.



D. ENGINE GUARD – CHROME



D. ENGINE GUARD – GLOSS BLACK



E. UNIVERSAL MOUNT HELMET LOCK



F. CENTER STAND



F. CENTER STAND

***WARNING:** These guards may provide limited leg and cosmetic vehicle protection under unique circumstances (fall over while stopped, very low speed slide). They are not made nor intended to provide protection from bodily injury in a collision with another vehicle or any other object.

Notice: The prices appearing in this catalog are the manufacturer's suggested retail prices. Actual retail prices may vary.

16 STREET™

Handlebars

A. REACH® HANDLEBAR*

This handlebar is designed to bring the controls 2 inches closer to the rider for increased comfort. The position is helpful for shorter riders, but also places almost any size rider in an upright, relaxed riding profile. Available in satin-black finish to complement your bike's overall design sense.

Handlebar Dimensions:

Bar Diameter – .88"	Rise – 8.25"
Tip-to-Tip – 30.00"	Base Width – 8.25"
Pull Back – 2.00"	Knurl Width – 3.25"

55800224 Satin Black. **\$69.95**

Fits '15-later XG models (except XG750A). Installation requires separate purchase of Clutch Cable P/N 37200077. ABS models require separate purchase of Front Brake Line P/N 41800611.

B. DRAG HANDLEBAR*

Nothing says minimalist like a classically simple drag bar. Shaped to give the Street™ model an aggressive riding profile, this 7/8" diameter flat Drag Bar features just 1.6" of pull back to provide an excellent combination of forward positioning and wrist control.

Handlebar Dimensions:

Bar Diameter – .88"	Rise – 0.00"
Tip-to-Tip – 30.50"	Base Width – 12.00"
Pullback – 1.60"	Knurl Center – 3.25"

55800225 Satin Black. **\$79.95**

Fits '15-later XG models (except XG750A). All models require separate purchase of additional installation components. ABS models require separate purchase of Front Brake Line P/N 41800610.

Also available:

FRONT BRAKE LINE FOR STREET MODELS – ABS

Enables fitment of accessory handlebars on ABS-equipped Harley-Davidson Street® model motorcycles.

41800611 **\$124.95**

Required for installation of Reach® Handlebar P/N 55800224 or 55800237 on '17-later XG models equipped with ABS brakes.

41800610 **\$124.95**

Required for installation of Drag Handlebar P/N 55800225 or 55800238 on '17-later XG models equipped with ABS brakes.

*NOTE: Installation of some handlebars and risers may require a change in clutch and/or throttle cable and brake lines for some models. Handlebar height is regulated in many states. Check state or local laws before installation.



A. REACH HANDLEBAR



B. DRAG HANDLEBAR



STREET HANDLEBAR COMPARISON

Notice: The prices appearing in this catalog are the manufacturer's suggested retail prices. Actual retail prices may vary.



NEW

C. DOMINION HAND GRIPS – GLOSS BLACK



NEW

C. DOMINION HAND GRIPS – BRONZE

DOMINION™ COLLECTION HAND GRIPS

Express your bold, renegade attitude. The Dominion™ Collection Rider and Passenger Controls let you set your own styling direction.

Fits '15-later XG models (except XG750A).

C. DOMINION COLLECTION HAND GRIPS

Crafted from aluminum and rubber, these Hand Grips feature a rugged surface that allows you to create your own unique look.

56100233	Gloss Black.	\$89.95
56100236	Bronze.	\$89.95

D. DOMINION COLLECTION FOOTPEGS

Crafted from aluminum, these Foot Pegs feature a rugged machined surface and interchangeable inserts in brushed black, bronze powder-coated or brushed orange anodized (sold separately) that allow you to create your own unique look.

50500947	Gloss Black.	\$149.95
50500949	Bronze.	\$149.95

E. DOMINION COLLECTION SHIFTER PEG

Crafted from aluminum, this Shifter Peg features a rugged machined surface and interchangeable inserts in brushed black, bronze powder-coated or brushed orange anodized (sold separately) that allow you to create your own unique look.

Fits '15-later XG models.

33600180	Gloss Black.	\$39.95
33600214	Bronze.	\$39.95

F. DOMINION COLLECTION TRIM

Make your bike a true custom of one. The Dominion Inserts allow you to customize Dominion Collection accessories, so your bike is truly one of a kind.

DOMINION COLLECTION FOOTPEG TRIM PIECE

Fits Dominion Footpegs.

50500938	Bronze.	\$29.95
50500940	Brushed Aluminum.	\$24.95
50500937	Brushed Black.	\$29.95
50500939	Brushed Orange.	\$29.95

DOMINION COLLECTION SHIFTER PEG TRIM PIECE

Fits Dominion Shifter Pegs P/N 33600180 and 33600214.

33600216	Bronze.	\$14.95
33600218	Brushed Aluminum.	\$14.95
33600215	Brushed Black.	\$14.95
33600217	Brushed Orange.	\$14.95



NEW

D. DOMINION FOOTPEGS – GLOSS BLACK

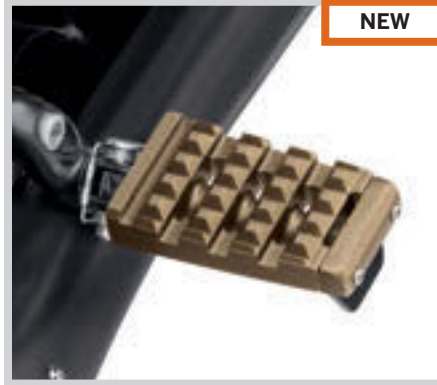

NEW

D. DOMINION FOOTPEGS – BRONZE



NEW

E. DOMINION SHIFTER PEG – GLOSS BLACK



NEW

E. DOMINION SHIFTER PEG – BRONZE



NEW

F. DOMINION FOOTPEG TRIM PIECE (BRUSHED ALUMINUM SHOWN)



NEW

F. DOMINION SHIFTER PEG TRIM PIECE (BRUSHED ORANGE SHOWN)

Notice: The prices appearing in this catalog are the manufacturer's suggested retail prices. Actual retail prices may vary.

18 STREET™

Hand & Foot Controls

A. KAHUNA™ COLLECTION HAND AND FOOT CONTROLS

Understated but powerful, The Kahuna™ Collection's rich gloss black or chrome surface is surrounded by rich deeply, grooved black rubber. A red Bar & Shield logo adds the finishing touch.

KAHUNA COLLECTION FOOTPEGS

Fits '15-later XG models (except XG750A).

50501148	Chrome.	\$139.95
50501225	Gloss Black.	\$139.95

KAHUNA COLLECTION SHIFTER PEG

Fits '15-later XG models.

33600256	Chrome.	\$39.95
33600257	Gloss Black.	\$39.95

B. EDGE CUT COLLECTION HAND AND FOOT CONTROLS

Live your life on the edge. The Edge Cut Collection features a crisp anodized finish that is machined to expose the highlights of raw aluminum. The contrasting cut back look makes a powerful visual statement and works great with both traditional and contemporary customizing styles.

Fits '15-later XG models (except XG750A).

56100083	Hand Grips.	\$84.95
49312-10	Footpegs.	\$84.95
34671-10	Shifter Peg.	\$29.95
42847-10	Brake Pedal Pad.	\$44.95

C. BRASS COLLECTION HAND AND FOOT CONTROLS

The authentic alternative to the typical chrome-covered or blacked-out look, the Harley-Davidson Brass Collection delivers a warm, hand-crafted look to your custom ride. These minimalistic "living finish" components make a garage-built styling statement and are the ideal addition to your stripped-down bobber or café motorcycle. Artistically manufactured from solid brass, these components feature a natural antique finish that will age and patina when exposed to the elements. Unlike bright polished and plated brass trim, these heritage-finished components are subtle additions to your ride and don't compete for attention with the rest of the bike. Brass Collection components are factory treated with wax to slow the aging process, and are shipped with cleaning and care instructions.

Fits '15-later XG models (except XG750A).

56100138	Hand Grips.	\$109.95
50500787	Footpegs.	\$159.95
33600093	Shifter Peg.	\$69.95
50600169	Brake Pedal Pad.	\$99.95



A. KAHUNA COLLECTION FOOT CONTROLS – CHROME



A. KAHUNA COLLECTION FOOT CONTROLS – GLOSS BLACK



B. EDGE CUT COLLECTION HAND GRIPS



B. EDGE CUT COLLECTION BRAKE PEDAL PAD AND FOOTPEGS



B. EDGE CUT COLLECTION FOOT CONTROLS



C. BRASS COLLECTION FOOT CONTROLS



C. BRASS COLLECTION HAND GRIPS



C. BRASS COLLECTION BRAKE PEDAL PAD AND FOOTPEGS

Notice: The prices appearing in this catalog are the manufacturer's suggested retail prices. Actual retail prices may vary.



D. DEFIANCE COLLECTION HAND AND FOOT CONTROLS – BLACK ANODIZED

DEFIANCE COLLECTION HAND AND FOOT CONTROLS
 Show your complete disregard for the rules. Anything but traditional, this complete collection of hand and foot controls refuses to conform to the everyday norms. Defined by sweeping curves, this design features a field of textured black rubber accented with deep longitudinal lines and a contemporary H-D logo. Available in your choice of chrome, black machine cut or full black finishes, the Defiance Collection sets a new rebellious direction in customizing.

D. DEFIANCE COLLECTION – BLACK ANODIZED

Fits '15-later XG models (except XG750A).

56100224	Hand Grips.	\$89.95
50500678	Footpegs.	\$129.95
50600187	Brake Pedal Pad.	\$49.95
33600111	Shifter Peg.	\$39.95

E. DEFIANCE COLLECTION – BLACK MACHINE CUT

Fits '15-later XG models (except XG750A).

56100223	Hand Grips.	\$99.95
50500540	Footpegs.	\$139.95
50600188	Brake Pedal Pad.	\$54.95
33600111	Shifter Peg.	\$39.95

F. DEFIANCE COLLECTION – CHROME

Fits '15-later XG models (except XG750A).

56100222	Hand Grips.	\$89.95
50500535	Footpegs.	\$129.95
50600182	Brake Pedal Pad.	\$49.95
33600100	Shifter Peg.	\$39.95

G. BURST COLLECTION FOOT CONTROLS

Split with tradition. The Burst Collection takes your ride in a new hard-edged direction. A rich mixture of tuxedo black, satin aluminum and textured rubber, each component in this complete collection seamlessly ties the look together. The Burst Collection components create an impact all by themselves, but can also be combined with edge cut and other black accessories to complete the look.

Fits '15-later XG models (except XG750A).

33600059	Footpegs – Round.	\$109.95
33600032A	Shifter Peg.	\$34.95
50600140	Brake Pedal Pad.	\$49.95



E. DEFIANCE COLLECTION HAND AND FOOT CONTROLS – BLACK MACHINE CUT



F. DEFIANCE COLLECTION HAND AND FOOT CONTROLS – CHROME



G. BURST COLLECTION FOOT CONTROLS

Notice: The prices appearing in this catalog are the manufacturer's suggested retail prices. Actual retail prices may vary.

20 STREET™

Hand & Foot Controls

A. ROUND BAR END MIRROR – SATIN BLACK*

Complete the cut-down Café bike look. These Bar End Mirrors provide a clean, streamlined look when compared to traditional mirrors. These round convex mirrors plug into the end of the handlebar to extend beyond the hand grip for an improved field of view on the bike equipped with narrow bars. When equipped with the Bar End Mirror Hand Grips (sold separately), the mirrors are simply inserted into the end of the grip and tightened in place. The mirrors are adjustable for maximum rear visibility, and can be positioned above the bar or, in some configurations, below the bar. When positioned below the bar, the left hand mirror is used on the right, and the right hand mirror moves to the left side. Includes hardware required to fit both 7/8" or 1" bars. Right and left mirrors are sold separately.



A. ROUND BAR END MIRROR – SATIN BLACK

Fits stock or accessory handlebars on '15-later XG (except models equipped with Drag Bar P/N 55800225 or 55800238), '02-'17 VRSC™ (except VRSCF), '96-later XL and XR, '96-'17 Dyna® (except FXDLS), '96-'15 Softail® (except FLSTNSE, FXSBSE and '11-'12 FLSTSE) and '96-'07 Touring models. Installation requires separate purchase of Diamond-Black Hand Grip P/N 56100199 (1") or 56100202 (7/8").

56000133 Right Hand (upright position). **\$99.95**

56000134 Left Hand (upright position). **\$99.95**

B. DIAMOND-BLACK HAND GRIPS – BAR END MIRRORS

Shroud your bike in mystery. This blacked-out hand and foot control collection features distinctive knurled surfaces that expose the raw billet aluminum for a dramatic contrast. Designed to age and break-in like a pair of comfortable stone-washed jeans, the satin black finish will complement both high-gloss and denim paint colors. Designed for use with Bar End Mirrors, these stripped-down Hand Grips feature glue-less installation that can be easily removed for service without damage. Grip End Caps are sold separately.

56100202 For 7/8" Diameter Bar. **\$99.95**

Fits '15-later XG models. Installation requires separate purchase of Bar End Mirrors P/N 56000133 and 56000134 or End Caps P/N 55900114.



B. DIAMOND-BLACK HAND GRIPS



C. HAND GRIP END CAPS

C. HAND GRIP END CAPS

Easy to install smooth End Caps fill the open end of the Diamond-Black Bar End Mirror Hand Grips if you remove the mirrors or select to use only a single mirror. Sold individually.

55900114 **\$15.95**

Fits models equipped with Diamond-Black Hand Grips P/N 56100199 and 56100202.

D. DIAMOND BLACK COLLECTION HAND AND FOOT CONTROLS

Shroud your bike in mystery. This collection features distinctive knurled surfaces that expose the raw billet aluminum for a dramatic contrast. The satin black finish will complement both high-gloss and denim paint colors and the narrow bands and the knurled surfaces provide a positive grip.

Fits '15-later XG models (except XG750A).

56100142 Hand Grips. **\$89.95**

50911-08A Footpegs. **\$84.95**

41850-08 Brake Pedal Pad. **\$44.95**

Fits '15-later XG models.

34690-08 Shifter Peg. **\$29.95**

Fits '17-later XG750A models.

50695-08A Footpegs with Wear Peg. **\$89.95**



D. DIAMOND BLACK COLLECTION HAND GRIPS

*Harley-Davidson Motor Company cannot test and make specific fitment recommendations concerning every possible mirror and handlebar combination. Therefore, after installing new mirrors or handlebars, and before operating the motorcycle, check to ensure that the mirrors provide the operator a clear view to the rear.



D. DIAMOND BLACK COLLECTION FOOT CONTROLS

Notice: The prices appearing in this catalog are the manufacturer's suggested retail prices. Actual retail prices may vary.



E. FORK TUBE AND STEERING STEM COVER KIT – GLOSS BLACK



F. FUEL TANK TRIM – GLOSS BLACK MACHINED

E. FORK TUBE AND STEERING STEM COVER KIT

Highlighted with an embossed Bar & Shield logo, these smooth covers enhance the clean look of the upper triple tree. Easy to install kit includes two press-in fork tube covers and a moon-shape steering stem cover.

45800056 Gloss Black. **\$54.95**
Fits '15-later XG models (except XG750A).

F. FUEL TANK TRIM – GLOSS BLACK MACHINED

Formed to hug the contour of the Street™ model's fuel tank, this billet aluminum trim panel visually stretches the tank and adds a luxurious finishing touch to the top surface. The rich black-anodized panel features deep machined speed lines that expose the shimmering aluminum for a distinctive look that complements a wide selection of Edge Cut or Cut Back accessories. The self-adhesive panel is easy to install, and it rests in a custom fitted rubber base gasket to protect the painted surfaces.

61400379 **\$124.95**
Fits '14-later XG models.

G. FUEL CAP MEDALLION – STREET™ MODELS

Decorative aluminum trim ring is the perfect finishing touch to your Original Equipment fuel cap. Contoured to the profile of the cap, the trim ring features adhesive backing for easy installation.

Fits '15-later XG models.
61300586 H-D Street Script. **\$24.95**
61300585 H-D Motor Co. Script. **\$24.95**



G. FUEL CAP MEDALLION – H-D STREET SCRIPT



G. FUEL CAP MEDALLION – H-D MOTOR CO SCRIPT

H. HARLEY-DAVIDSON® MOTOR CO. COLLECTION – BLACK WITH CHROME SCRIPT

An aggressive twist on a classic style. The Harley-Davidson® Motor Co. Collection features a rich gloss black surface, trimmed with deep-cut silver-filled lettering that surrounds a central groove. The clean design and the luxurious finish are the perfect match for blacked-out engine cases.

61300228 Air Cleaner Trim. **\$49.95**
Fits '15-later XG models (except XG750A) with Original Equipment air cleaner cover.
25600034 Right Side Medallion. **\$29.95**
Fits '15-later XG models.
25700308 Left Side Medallion. **\$29.95**
Fits '15-later XG models.



H. HARLEY-DAVIDSON MOTOR CO. COLLECTION BLACK WITH CHROME SCRIPT – AIR CLEANER TRIM



H. HARLEY-DAVIDSON MOTOR CO. COLLECTION BLACK WITH CHROME SCRIPT – RIGHT SIDE MEDALLION



H. HARLEY-DAVIDSON MOTOR CO. COLLECTION BLACK WITH CHROME SCRIPT – LEFT SIDE MEDALLION

Notice: The prices appearing in this catalog are the manufacturer's suggested retail prices. Actual retail prices may vary.

22 STREET™

Engine Trim

A. WILLIE G SKULL COLLECTION – BLACK

Penned at the hand of Willie G, the famous Skull Collection makes a shift to the dark side. Completely drenched in black, the raised skull and surrounding Harley-Davidson Motorcycles script adds a subtle ominous touch to your ride. The finish easily coexists alongside gloss black or wrinkle black surfaces. The complete collection of components includes matching black hardware.

29400343 Air Cleaner Trim. **\$49.95**
Fits '15-later XG models (except XG750A) with Original Equipment air cleaner cover.

25800100 Right Side Medallion. **\$29.95**
Fits '15-later XG models.

25800114 Left Side Medallion. **\$29.95**
Fits '15-later XG models.

B. WILLIE G SKULL COLLECTION – CHROME

Add a little attitude to your ride. Styled to complement Harley-Davidson® Skull accessory items, the menacing raised skull with black-filled eyes leaps from a field of chrome. The surrounding Harley-Davidson Motorcycles script is the perfect finishing touch. This complete collection of engine covers dresses your bike for a true custom look.

61300520 Air Cleaner Trim. **\$49.95**
Fits '15-later XG models (except XG750A) with Original Equipment air cleaner cover.

25600044 Right Side Medallion. **\$29.95**
Fits '15-later XG models.

25700460 Left Side Medallion. **\$29.95**
Fits '15-later XG models.



A. WILLIE G SKULL COLLECTION – AIR CLEANER TRIM – BLACK



A. WILLIE G SKULL COLLECTION RIGHT SIDE MEDALLION – BLACK



A. WILLIE G SKULL COLLECTION LEFT SIDE MEDALLION – BLACK



B. WILLIE G SKULL COLLECTION – AIR CLEANER TRIM – CHROME



B. WILLIE G SKULL COLLECTION – RIGHT SIDE MEDALLION – CHROME



B. WILLIE G SKULL COLLECTION – LEFT SIDE MEDALLION – CHROME

Notice: The prices appearing in this catalog are the manufacturer's suggested retail prices. Actual retail prices may vary.



C. DARK CUSTOM LOGO COLLECTION – AIR CLEANER TRIM

C. DARK CUSTOM LOGO COLLECTION

Make a bold statement with these easy to install, black anodized and machined billet medallions.

61300227	Air Cleaner Trim.	\$89.95
Fits '15-later XG models (except XG750A) with Original Equipment air cleaner cover.		
25600033	Right Side Medallion.	\$64.95
Fits '15-later XG models.		
25700307	Left Side Medallion.	\$64.95
Fits '15-later XG models.		

D. BRASS COLLECTION

The authentic alternative to the typical chrome-covered or blacked-out look, the Harley-Davidson® Brass Collection delivers a warm, hand-crafted look to your custom ride. These minimalistic "living finish" components make a garage-built styling statement and are the ideal addition to your stripped-down bobber or café motorcycle. Artistically manufactured from solid brass, these components feature a natural antique finish that will age and patina when exposed to the elements. Unlike bright polished and plated brass trim, these heritage-finished components are subtle additions to your ride and don't compete for attention with the rest of the bike. Brass Collection components are factory treated with wax to slow the aging process, and are shipped with cleaning and care instructions.

25800089	Right Side Medallion.	\$84.95
Fits '15-later XG models.		
25800091	Left Side Medallion.	\$84.95
Fits '15-later XG models.		



C. DARK CUSTOM LOGO COLLECTION – RIGHT SIDE MEDALLION



C. DARK CUSTOM LOGO COLLECTION – LEFT SIDE MEDALLION



D. BRASS COLLECTION – RIGHT SIDE MEDALLION



D. BRASS COLLECTION – LEFT SIDE MEDALLION

Notice: The prices appearing in this catalog are the manufacturer's suggested retail prices. Actual retail prices may vary.

24 STREET™

Chassis Trim

A. DOMINION™ COLLECTION FRONT AXLE NUT COVERS

Express your bold, renegade attitude. The machined aluminum Dominion™ Collection Rear Axle Nut Covers add style to the front of the bike and are the perfect complement to other Dominion Collection accessories.

Fits '15-later XG models.

43000124 Gloss Black. **\$74.95**

43000123 Bronze. **\$74.95**

B. WILLIE G SKULL COLLECTION FRONT AXLE NUT COVERS

Penned at the hand of Willie G, the famous Skull Collection adds a little attitude to your ride. Completely drenched in black or chrome with black filled accents, the raised skull and surrounding Harley-Davidson Motorcycle script adds a subtle ominous touch to your ride. The Axle Nut Covers are easy to install and include all necessary mounting hardware. Sold in pairs.

Fits '15-later XG models.

43000096 Black. **\$34.95**

43163-08A Chrome. **\$34.95**

C. FRONT AXLE NUT COVERS

Cover the front axle in style. These smooth custom, die-cast Axle Nut Covers look great and add the finishing touch to complete a custom front end. These Axle Cover Kits are easy to install and include all necessary mounting hardware. Sold in pairs.

Fits '15-later XG models.

43000026 Gloss Black. **\$29.95**

44117-07A Chrome. **\$29.95**

D. FRONT AXLE NUT COVERS – BRASS COLLECTION

Artistically manufactured from solid brass, these components feature a natural antique finish that will age and patina when exposed to the elements. The Brass Collection Axle Nut Covers look great with Original Equipment satin-finish fork sliders or as the finishing touch to a blacked-out front end. Easy to install kits include all necessary mounting hardware. Sold in pairs.

43000046 **\$54.95**

Fits '15-later XG models.

E. FRONT AXLE NUT COVERS – DEFIANCE COLLECTION

Start a new tradition. Deep radial grooves and a contemporary H-D logo define the style Defiance Collection Front Axle Nut Covers. Available in your choice of chrome or black machine cut finish, these easy to install elements complement polished, chrome or blacked-out front end components. Sold in pairs.

Fits '15-later XG models.

43000062 Chrome. **\$74.95**

43000064 Black Machine Cut. **\$74.95**



A. DOMINION FRONT AXLE NUT COVERS – GLOSS BLACK



A. DOMINION FRONT AXLE NUT COVERS – BRONZE



B. WILLIE G SKULL FRONT AXLE NUT COVERS – BLACK



B. WILLIE G SKULL FRONT AXLE NUT COVERS – CHROME



C. FRONT AXLE NUT COVERS – GLOSS BLACK



C. FRONT AXLE NUT COVERS – CHROME



D. FRONT AXLE NUT COVERS – BRASS COLLECTION



E. FRONT AXLE NUT COVERS – DEFIANCE COLLECTION (BLACK MACHINE CUT SHOWN)

Notice: The prices appearing in this catalog are the manufacturer's suggested retail prices. Actual retail prices may vary.

**F. REAR AXLE NUT COVERS – GLOSS BLACK****G. SWINGARM PIVOT BOLT COVERS – GLOSS BLACK****H. COOLANT HOSE COVER KIT – GLOSS BLACK****I. TYPHOON CUSTOM WHEEL – CUT BACK GLOSS BLACK****J. POLISHED BRAKE ROTORS****F. REAR AXLE NUT COVERS**

Cover the rear axle in style. These smooth Axle Nut Covers look great and add the finishing touch to complete the custom look. These easy to install Axle Cover Kits include all necessary mounting hardware. Sold in pairs.

43000018 Gloss Black. **\$29.95**
Fits '15-later XG models.

G. SWINGARM PIVOT BOLT COVERS – GLOSS BLACK

Conceal the swingarm pivot bolt in classic style. These easy to install gloss black covers hide the Original Equipment hardware and add a clean custom touch to the bike's profile. Complete kit includes left and right die-cast pivot bolt covers and necessary mounting hardware.

61400269 **\$31.95**
Fits '15-later XG models.

H. COOLANT HOSE COVER KIT

Add a finishing touch to the left side profile of the Harley-Davidson Street® motorcycle. This easy to install one-piece cover dresses the bike and protects the coolant hoses below the coil cover.

26900108 Gloss Black. **\$64.95**
Fits '15-later XG models.

I. TYPHOON CUSTOM WHEEL

An intense storm is brewing. Nine arching spokes spin outward from the hub and blend seamlessly with the rim to add forward motion, even while standing still. The flat profile spokes and carved webs add visual intensity and tailor your bike to fit the mood. Requires separate purchase of model-specific Wheel Installation Kit, Sprocket Hardware and Brake Rotor Hardware.

Front – Fits '15-later XG models (except XG750A).

43300351 17" Front, Cut Back Gloss Black. **\$459.95**

Rear – Fits '15-later XG models (except XG750A).

40900358 15" Rear, Cut Back Gloss Black. **\$459.95**

Also available:

WHEEL INSTALLATION KIT

Once you select your wheel style, select the Wheel Installation Kit designed specifically for your motorcycle. Kit includes the bearings and spacers required for installation.

42400008 Front, 25mm Axle. **\$79.95**
Fits '15-later XG models, '08-later XL models without ABS brakes and '13-'17 FXSB models without ABS brakes.

41451-08C Rear, 25mm Axle. **\$79.95**
Fits '15-later XG, '16-later XL1200CX, '18-later XL1200NS and XL1200XS and '08-'17 Dyna® models without ABS brakes.

J. POLISHED BRAKE ROTORS

A perfect complement to stock or custom wheels. Manufactured to Original Equipment specifications for exact fit, these rotors are meticulously polished to achieve a chrome-like appearance. Rotors are sold individually and include chrome installation hardware.

Fits '15 XG models only.

41500096 Front, Left. **\$149.95**

41500097 Rear, Right. **\$149.95**

26 STREET™

Screamin' Eagle® Performance

A. SCREAMIN' EAGLE® PERFORMANCE AIR CLEANER KIT – STREET ROD®

This kit provides a freer breathing capability to pump-up the power of your EFI-equipped motorcycle. Air Cleaner features a washable, high-flow, oiled cotton media element. Kit includes a high-flow air filter element, and a Screamin' Eagle® Air Cleaner Medallion. ECE and 50-State U.S. EPA compliant.

29400350 **\$79.95**
Fits '17-later XG750A models.

Also available:

SCREAMIN' EAGLE AIR CLEANER INSERT

Dress your air cleaner in style. Easy-to-install medallion features brilliant Screamin' Eagle script set against a rich black background. Self-adhesive backing for easy installation.

61300835 **\$19.95**
Fits '17-later XG750A models.



A. SCREAMIN' EAGLE PERFORMANCE AIR CLEANER KIT – STREET ROD

B. SCREAMIN' EAGLE PERFORMANCE AIR CLEANER KIT – STREET™

This kit provides a freer breathing capability to pump-up the power of your EFI-equipped motorcycle. Air Cleaner features a washable high-flow, oiled cotton media element. Kit includes a high-flow air filter element, Screamin' Eagle Air Cleaner Medallion and all required hardware. 50-State U.S. EPA compliant.

29400197 **\$79.95**
Fits '15-later XG models (except XG750A). '17-later models require recalibration with Screamin' Eagle Pro Street Tuner (sold separately). Labor cost not included. See Dealer for details.

Also Available:

SCREAMIN' EAGLE AIR CLEANER MEDALLION

Dress your air cleaner in style. Easy-to-install medallion features brilliant Screamin' Eagle script and Harley-Davidson lettering set against a rich black background. Self-adhesive backing for easy installation.

61300364A **\$19.95**
Fits '15-later XG models (except XG750A).



B. SCREAMIN' EAGLE PERFORMANCE AIR CLEANER KIT – STREET

C. SCREAMIN' EAGLE 10MM PHAT SPARK PLUG WIRES

Fat 10mm plug wires add dimension and style to your ride. Screamin' Eagle boot design and suppression core wires ensure solid connection and maximum voltage transfer between coil and plugs. Screamin' Eagle logo printed along the wire to add style.

Fits '15-later XG models.

31600048A Black. **\$29.95**
31600054A Red. **\$29.95**
31600051A Orange. **\$29.95**



C. SCREAMIN' EAGLE 10MM PHAT SPARK PLUG WIRES

D. MUFFLER END CAP – EDGE CUT

This Edge Cut End Cap kit allows you to personalize your Original Equipment mufflers. These easy-to-install caps are dressed with the same black-anodized finish as the Edge Cut Collection for a consistent look front to back and feature machined aluminum accents for a modern touch.

65100056 **\$89.95**
Fits '15-later XG models (except XG750A) with Original Equipment muffler.



D. MUFFLER END CAP – EDGE CUT

GO LIGHT

These Screamin' Eagle products are 50-state street compliant for sale and use on all vehicles, including those that are pollution-controlled. Complies with the requirements of 40 CFR Part 86, subparts E and F. Street legal and/or street compliant statements refer to product meeting 50-State emissions and noise standards in the United States.

*NOTE: There is no warranty on exhaust pipes and mufflers with regard to any discoloration. Blueing is caused by tuning characteristics, cam timing, carburetor jetting, over-heating, etc. and is not caused by defective manufacturing.

Notice: The prices appearing in this catalog are the manufacturer's suggested retail prices. Actual retail prices may vary.



E. SCREAMIN' EAGLE STREET PERFORMANCE SLIP-ON MUFFLER



F. SCREAMIN' EAGLE NIGHTSTICK 2-INTO-1 SLIP-ON MUFFLER – JET BLACK



G. SCREAMIN' EAGLE BUCKSHOT EXHAUST SHIELD KIT – JET BLACK

E. SCREAMIN' EAGLE® STREET PERFORMANCE SLIP-ON MUFFLER

These street-compliant high-flow mufflers have been specifically tuned to deliver an aggressive exhaust note and improved performance. Developing a rich exhaust note throughout the RPM range, these mufflers provide deep base rumble and a throaty tone while on the throttle. The heat-resistant satin black ceramic finish complements the blacked-out look of the Street Rod® model, and the contrasting bright stainless end cap is finished with a laser-engraved Screamin' Eagle® logo for a finishing touch.

64900683 **\$324.95**

Fits '17-later XG750A models. All models require ECM calibration with Screamin' Eagle Pro Street Tuner (sold separately). 50 state U.S. and ECE compliant.

F. SCREAMIN' EAGLE NIGHTSTICK 2-INTO-1 SLIP-ON MUFFLER – JET BLACK*

Tuned by the factory for the ultimate combination of rich tone and legal sound levels, this slip-on muffler is the perfect match for your Harley-Davidson® model. The high-flow design of the external diffusion discs produces plenty of low-end "guts" to get your bike away from the light and a fat torque curve that gets you quickly around slow-moving traffic. The multiple stainless steel diffusion discs and domed end cap deliver an aggressive raspy sound. Available in jet black finish, these long and lean pipes feature an embossed Screamin' Eagle logo. Easy to install. 50-State U.S. EPA compliant.

64900220 **\$349.95**

Fits '15-later XG models (except XG750A). '17-later models require recalibration with Screamin' Eagle® Pro Street Tuner (sold separately). Labor cost not included. See Dealer for details.

G. SCREAMIN' EAGLE BUCKSHOT EXHAUST SHIELD KIT – JET BLACK

These custom exhaust shields feature a perforated "Buckshot" design to expose the head pipe for a raw rebellious look. These exhaust shields are a perfect match for Original Equipment or Screamin' Eagle muffler and complement the blacked out Harley-Davidson Street® model. Manufactured to Original Equipment standards for exacting fit, the easy-to-install kit includes front and rear head pipe shields.

65400167 **\$149.95**

Fits '15-later XG models.

GO LIGHT These Screamin' Eagle products are 50-state street compliant for sale and use on all vehicles, including those that are pollution-controlled. Complies with the requirements of 40 CFR Part 86, subparts E and F. Street legal and/or street compliant statements refer to product meeting 50-State emissions and noise standards in the United States.

*NOTE: There is no warranty on exhaust pipes and mufflers with regard to any discoloration. Blueing is caused by tuning characteristics, cam timing, carburetor jetting, over-heating, etc. and is not caused by defective manufacturing.

Notice: The prices appearing in this catalog are the manufacturer's suggested retail prices. Actual retail prices may vary.



V-ROD MUSCLE®

V-ROD® | VRSCF | VIVID BLACK

A liquid-cooled legend of sight and sound. Body-rumbling performance and high-tech style. Made for the bold and the brave, and with mile-eating performance and race-inspired styling, you'll never have to ask for attention. The V-Rod Muscle® motorcycle proudly demands it.



Cast Upright & One-Piece Luggage Rackp32



Front Brake Caliper Kit p34



Get-A-Grip™ Hand Grips (Chrome)..... p608



Polished Brake Rotors — Front..... p34

30 V-ROD®

Windshields

A. QUICK-RELEASE COMPACT MID-SPORT WINDSHIELD

Shaped to split the wind. This tough, hard-coated polycarbonate Mid-Sport Windshield wraps around the headlamp to offer the maximum wind protection available in a compact profile. The windshield mounts to the fork tubes with elegant die-cast lever-release clamps and to the handlebar with "plug-in" docking points, so the windshield does not require any "leave-behind" hardware. You get quick on-and-off convenience and a clean, custom look. No tools are required.

57610-09 18" Light Smoke. **\$349.95**

Fits '09-'17 VRSCF models. Windshield dimensions:
Overall height – 20"; width – 17.5".

57400060 18" Light Smoke. **\$359.95**

Fits '12-'17 VRSCDX models. Windshield dimensions: Overall
height – 24"; width – 17.5".

B. QUICK-RELEASE TOURING WINDSHIELD

The Touring Windshield features an aerodynamic design shaped to provide hours of riding comfort. The additional center width directs airflow past the hand grips and deflects rain and road debris around the rider. The windshield mounts to the fork tubes with elegant die-cast lever-release clamps, so the windshield does not require any "leave-behind" docking hardware. You get quick on-and-off convenience and a clean, custom look. No tools are required. The tough, hard-coated polycarbonate windshield features a stylish horizontal brace with the Bar & Shield logo to accent the long, lean look of the V-Rod® model. Kit includes Turn Signal Relocation Kit.

57211-05 23" Clear. **\$429.95**

Fits '02-'10 VRSCA, '04-'05 VRSCB and '07 VRSCX models.

'05 VRSCB models require separate purchase of Headlamp
Visor P/N 67750-88T and Visor Screw P/N 3383. Windshield
dimensions: Overall height – 27.4"; width – 23.0".

C. SUPER SPORT WINDSHIELD

Super is an apt description for this do-it-all shield. Easily removable, this sporty windshield provides protection from the elements when you need it. The high-quality light smoke shield is hard-coated to resist scratching.

57109-01 21" Light Smoke. **\$339.95**

Fits '02-'10 VRSCA models. Windshield dimensions:

Overall height 21.5"; width 18.3".



A. QUICK-RELEASE COMPACT MID-SPORT WINDSHIELD (VRSCF SHOWN)



A. QUICK-RELEASE COMPACT MID-SPORT WINDSHIELD ('12-LATER VRSCDX SHOWN)



B. QUICK-RELEASE TOURING WINDSHIELD



C. SUPER SPORT WINDSHIELD

Notice: The prices appearing in this catalog are the manufacturer's suggested retail prices. Actual retail prices may vary.



D. SUNDOWNER RIDER SEAT – 52000048 SHOWN

D. SUNDOWNER™ RIDER SEAT

The Sundowner™ Seat provides the ultimate in long-riding comfort. The deep bucket design places your body in the proper upright touring position and the generous padding keeps you comfortable as the miles add up. The contoured seating surface distributes your weight over a wider surface to reduce pressure points and the dished shape provides added rider back support. Available to fit many models, Sundowner Seats retain the Original Equipment pivot mounting for easy access to the fuel filler. Styled to match the Original Equipment passenger pillion, this rider touring seat features a contoured bucket that provides additional lower back support.

52000048**\$249.95**

Fits '12-'17 VRSCDX models. Seat width 16.0".

E. SUNDOWNER RIDER SEAT AND PILLION

Designed for the long haul, this touring seat and passenger pillion combination continues the comfort tradition of the Sundowner line. With both the rider and passenger in mind, this seat features a deep contoured rider position to provide added lower back support and a wide passenger pillion for superior passenger comfort.

53432-02**\$339.95**

Fits '02-'06 VRSCA, VRSCB, and VRSCD and '05-'06 VRSCSE models. Requires use of Fender Base Plate or One-Piece Luggage Rack (sold separately). Seat width 15.5"; pillion width 12.0".



E. SUNDOWNER RIDER SEAT AND PILLION – '02-'06 MODELS

F. REACH® RIDER SEAT

Designed to position riders with a shorter inseam closer to the ground, Reach® Seats are shaped to place the rider in a comfortable and confident relationship to the hand and foot controls. The wide seating surface provides loads of support while riding and the narrow tapered nose brings your legs together for an easier reach to the ground at a stop. Reach Seats feature a stepped profile that provides back support and keeps the rider from sliding back during acceleration. Reach Seats retain the Original Equipment pivot mounting for easy access to the fuel filler. This low-profile Reach Rider Seat moves the rider forward for improved access to the hand and foot controls and minimizes the leg stretch to the ground at a stop or while parking the bike. The seat is styled to match the Original Equipment passenger pillion.

52000049**\$239.95**

Fits '12-'17 VRSCDX models. Seat width 15.0".



F. REACH RIDER SEAT

Notice: The prices appearing in this catalog are the manufacturer's suggested retail prices. Actual retail prices may vary.

32 V-ROD®

Seating, Backrests & Racks

A. TOURING PASSENGER PILLION

Although the VRSC™ family of motorcycles is built for speed, it can also make a radical touring machine. This wide and contoured Passenger Pillion is shaped to deliver maximum passenger comfort for long hauls or around-town riding.

51780-07 **\$99.95**

Fits '07-'11 VRSC models (except VRSCF and VRSCR). Requires separate purchase of model-specific Fender Base Plate. Pillion width 11.0".

B. CAST UPRIGHT AND BACKREST PAD

Accent the low and lean look of the motorcycle with this highly styled cast passenger backrest. The unique cast upright with hidden hardware and the silver powder-coated finish blends with the bike to form a functional, yet stylish backrest. The backrest pad complements the Original Equipment seat. Kit includes upright, pad and mounting hardware.

51600-09 **\$179.95**

Fits '09-'17 VRSCF models. Requires separate purchase of Upright Installation Kit P/N 51607-09 or Cast One-Piece Luggage Rack P/N 53315-09.

52300016 **\$179.95**

Fits '12-'17 VRSCDX models. Requires separate purchase of Cast One-Piece Luggage Rack P/N 50300028.

Also available:

UPRIGHT INSTALLATION KIT – VRSCF

Required for installation of Cast Upright and Backrest Pad P/N 51600-09 when installed without Cast One-Piece Luggage Rack P/N 53315-09. Installation requires drilling holes in rear fender.

51607-09 **\$29.95**

Fits '09-'17 VRSCF models.

C. CAST ONE-PIECE LUGGAGE RACK*

Beautifully die-cast, polished and finished in satin chrome, the one-piece design features hidden mounting hardware for a seamless style. The long rearward sweep continues the lines of the rear fender and the angular design blends with the passenger pillion for a true custom look. The rack looks great alone or can be installed with the matching Cast Sissy Bar Upright for added functionality. Installation requires drilling holes in rear fender.

53315-09 **\$184.95**

Fits '09-'17 VRSCF models.

50300028 **\$184.95**

Fits '12-'17 VRSCDX models.



A. TOURING PASSENGER PILLION



B. CAST UPRIGHT AND BACKREST PAD (VRSCF SHOWN WITH UPRIGHT INSTALLATION KIT)



B. CAST UPRIGHT AND BACKREST PAD (VRSCDX SHOWN WITH CAST ONE-PIECE LUGGAGE RACK)



C. CAST ONE-PIECE LUGGAGE RACK (VRSCF SHOWN)



C. CAST ONE-PIECE LUGGAGE RACK (VRSCDX SHOWN)



***WARNING:** Do not use this rack as a seat. Do not exceed the fender rack weight capacity. Using as seat or exceeding this capacity could cause handling problems which could result in loss of control and death or serious injury.

Notice: The prices appearing in this catalog are the manufacturer's suggested retail prices. Actual retail prices may vary.



D. TOURING PASSENGER BACKREST PAD



E. COMPACT PASSENGER BACKREST PAD (51782-07 SHOWN)

D. TOURING PASSENGER BACKREST PAD

This wide Touring Backrest is shaped to provide added passenger comfort and support.

51783-07 **\$99.95**

Fits '07-'11 VRSC™ (except VRSCF), '06-'07 VRSCR and '06 VRSCSE models equipped with Low Sissy Bar Upright P/N 51162-06 or 51313-07. Also fits Dyna® models equipped with Sissy Bar Upright P/N 52726-09.

E. COMPACT PASSENGER BACKREST PADS

This backrest sports a smooth, clean finish that looks great with any smooth surface seat.

51583-01 **\$89.95**

Fits '02-'06 VRSCA, VRSCB and VRSCD models equipped with Low Sissy Bar Upright P/N 51126-01A or 51145-04A.

51782-07 **\$79.95**

Fits '07-'11 VRSC (except VRSCF), '06-'07 VRSCR and '06 VRSCSE models equipped with Sissy Bar Upright P/N 51162-06 or 51313-07, '06-'17 Dyna models equipped with Sissy Bar Upright P/N 52726-09 and FXCW models equipped with Sissy Bar Upright P/N 52804-08.

F. CHROME HARDWARE KITS – VRSC™ SISSY BAR AND LUGGAGE RACK

Finish the show-winning look with brilliant chrome hardware.

1. 94112-04 Sissy Bar Upright and Base Plate. **\$24.95**

Fits '02-'11 VRSC models (except VRSCF) equipped with a Fender Base Plate and a Sissy Bar Upright.

2. 94263-04 Luggage Rack. **\$24.95**

Fits '02-'11 VRSC models (except VRSCF) equipped with Luggage Rack P/N 51119-01A or 51142-04A.

G. AIR BOX COVER BRA

Protect the finish of your VRSC™ model's air box cover from scratches caused by keys, belt buckles and road debris. This tank bra is made with non-abrasive, fleece-backed vinyl and features an embroidered Bar & Shield logo. Designed for easy installation and a custom fit.

57850-01 **\$59.95**

Fits '02-'17 VRSC models (except VRSCF).

H. DOCUMENT HOLDER

This Document Holder provides a convenient storage space under the VRSC hinged seat or in saddlebags. The clear zip-closure pouch attaches to the underside of the seat or to the interior of a saddlebag with convenient hook-and-loop strips and the pouch can be removed and replaced with a simple lift and pull.

94206-03 **\$10.95**

Fits '02-'17 VRSC models (except VRSCR).

I. FRAME BAG

Great for small items like cell phones and sunglasses, this compact bag tucks neatly in the left side of the frame for a clean look.

94204-03A **\$34.95**

Fits '02-'17 VRSC models (except VRSCR).



F. CHROME HARDWARE KITS – VRSC SISSY BAR AND LUGGAGE RACK



G. AIR BOX COVER BRA



H. DOCUMENT HOLDER



I. FRAME BAG

Notice: The prices appearing in this catalog are the manufacturer's suggested retail prices. Actual retail prices may vary.

34 V-ROD®

Brakes & Chassis Trim

A. BRAKE CALIPER KIT – RED

Dress your bike in the latest high-performance look. Brilliant red calipers make a powerful visual statement and set your bike apart from the ordinary. Manufactured from Original Equipment components for proven performance, these calipers will add a stylish touch to the stock bike or add the perfect finish to a complete custom equipped with chrome or blacked-out wheels, rotors and fork sliders.

41300116 Front – Dual Disc. **\$499.95**
Fits '06-'17 VRSC™, '08-later Touring and '09-'13 and '19-later Trike models. Brake pads sold separately.



A. BRAKE CALIPER KIT – RED
(41300116 SHOWN)

B. BRAKE CALIPER KIT – CHROME

Add the shine of chrome to your bike with these highly polished Chrome Brake Caliper Kits. Manufactured from Original Equipment components for proven performance, these calipers are a great addition to the stock bike or add the finishing touch to a complete custom equipped with chrome wheels, rotors, fork sliders and swingarm.

42012-06A Front – Dual Disc. **\$899.95**
Fits '06-'17 VRSC, '08-later Touring and '09-'13 and '19-later Trike models. Brake pads sold separately.

44392-00A Front – Dual Disc. **\$799.95**
Fits '02-'05 VRSC, '00-'03 XL, '00-'07 Dyna® and '00-'07 Touring models with dual disc front brakes. Brake pads sold separately.



B. BRAKE CALIPER KIT – CHROME
(42012-06A SHOWN)

C. CALIPER SCREEN INSERT – GLOSS BLACK

Complete the blacked-out transformation. Gloss black inserts replace the satin-finish screens featured on Harley-Davidson® Original Equipment Brembo® brakes, and add a rich complement to the wrinkle black caliper finish. Easy pop-in installation. Sold individually.

41300154 Front. **\$29.95**
Fits '06-'17 VRSC™, '08-later Touring and '09-'13 and '19-later Trike models.



C. CALIPER SCREEN INSERT – GLOSS BLACK

D. CALIPER SCREEN INSERT – CHROME

Chrome-plated caliper inserts replace the Original Equipment satin-finish screens featured on Brembo® Brake Calipers. Easy pop-in installation. Sold individually.

42054-05 Front. **\$29.95**
Fits '06-'17 VRSC, '08-later Touring and '09-'13 and '19-later Trike models.



D. CALIPER SCREEN INSERT – CHROME

E. SWINGARM PIVOT BOLT COVERS

Complete the radical styling of your VRSC™ model's swingarm with these custom Pivot Bolt Covers. Easy press-fit installation. Sold in pairs.

Fits '02-'17 VRSC models.

48893-01 Chrome. **\$29.95**
47647-09 Gloss Black. **\$29.95**



E. SWINGARM PIVOT BOLT COVERS – CHROME

F. REAR AXLE COVERS – GLOSS BLACK

This one-piece axle cover blends into the unique styling of the rear swingarm and covers the rear axle and axle adjuster for a finished look.

43430-09 **\$46.95**
Fits '02-'17 VRSC models.



E. SWINGARM PIVOT BOLT COVERS – GLOSS BLACK

G. POLISHED BRAKE ROTORS

A perfect complement to stock or custom wheels. Manufactured to Original Equipment specifications for exact fit, these rotors are meticulously polished to achieve a chrome-like appearance. Rotors are sold individually and include chrome installation hardware.

41500012A Front. **\$149.95**
Fits '06-'17 VRSC and Dyna® models (except FXDF). Also Fits '08-later Touring and Trike models. Requires Original Equipment or Accessory wheel with 6.7" bolt circle rotor mount. Does not fit Enforcer or Impeller wheels.



F. REAR AXLE COVERS – GLOSS BLACK



G. POLISHED BRAKE ROTORS

Notice: The prices appearing in this catalog are the manufacturer's suggested retail prices. Actual retail prices may vary.



H. BILLET HEADLAMP SHELL (SHOWN WITH INSTALLATION BRACKET AND TURN SIGNAL RELOCATION KIT)

H. BILLET HEADLAMP SHELL

Add style and substance to the front fork with this bullet-shaped Headlamp Shell. Manufactured from billet aluminum, this extended headlamp housing recesses the headlamp for a true custom appearance. The mirror-finish chrome surfaces and the close-fitting inner trim ring create the appearance of a one-piece design. Kit includes chrome-plated mounting hardware and a custom billet mount.

67704-03 **\$339.95**

Fits '99-'05 FXDWG and '00-'17 FXS, FXSB, FXSBSE, FXST, FXSTB, FXSTC and FXSTD models. Also fits '02-'11 VRSC™ models (except VRSCF) equipped with Installation Bracket P/N 68211-05. Not compatible with LED headlamps. (Does not fit International models.)

Shown with:

BILLET HEADLAMP INSTALLATION BRACKET

Add to the long and lean look of the VRSC™ model family. This bracket allows you to replace the Original Equipment headlamp with the mirror chrome extended Billet Headlamp Shell.

68211-05 **\$179.95**

Fits '02-'11 VRSCA, VRSCAW, VRSCB, VRSCD and VRSCX models. Requires separate purchase of Billet Headlamp Shell Kit P/N 67704-03 and Headlamp Bulb P/N 68297-05A. VRSCD models require removal of Original Equipment Color-Matched Speed Screen Visor.



I. TURN SIGNAL RELOCATION KIT



J. SCREAMIN' EAGLE FORK BRACE – CHROME

I. TURN SIGNAL RELOCATION KIT

Styled to blend with the lower triple clamp. This chrome-plated Turn Signal Relocation Kit moves the Original Equipment bullet-style turn signals from the handlebar to the front fork for a clean, streamlined look. Kit includes left and right mounting stalk and all required hardware.

57205-05 **\$45.95**

Fits '02-'10 VRSCA, VRSCB and VRSCD and '07-'11 VRSCX and VRSCDX models.

J. SCREAMIN' EAGLE® FORK BRACE

These chrome fork braces are machined from billet aluminum, then polished and chrome-plated to complement the curve of the front fender. The machined Screamin' Eagle® logo finishes the look with crisp detail. Easy-to-install, these braces offer increased torsional rigidity. Does not fit with Fluted Fork Slider Dust Covers.

46595-06A **\$229.95**

Fits '02-'08 VRSCA, VRSCB, VRSCD, VRSCX and '06-'17 FXD, FXDB, FXDC, FXDL and FXDLS models.

K. 5-SPOKE CAST ALUMINUM WHEEL

Dress your V-Rod® motorcycle in the latest style. First introduced on the 2008 Night Rod® model, these black and polished 5-Spoke Wheels add a touch of attitude to your early VRSC™ model.

43634-08 19" Front. **\$659.95**

Fits '02-'07 VRSC™ models. Original Equipment on '08 VRSCD. Requires separate purchase of model-specific Wheel Installation Kit. '07 VRSCX models and other models equipped with laced front wheel also require additional purchase of (2) Front Brake Rotors P/N 44553-06A.

43635-08 18" Rear (180/55 Tire). **\$659.95**

Fits '02-'06 VRSCA and VRSCB models and '06-'08 VRSCD and VRSCR models. Does not fit models equipped with 240mm rear tire. Requires separate purchase of model-specific Wheel Installation Kit.



K. 5-SPOKE CAST ALUMINUM WHEEL

Notice: The prices appearing in this catalog are the manufacturer's suggested retail prices. Actual retail prices may vary.

36 V-ROD®

Handlebars & Hand Controls

A. REACH® HANDLEBAR*

With a shape designed to place the handlebar closer to the rider, this Reach® Handlebar puts the rider in an upright seating position for added comfort and control. Bar provides 4.0" pull back and 1.5" of rise over stock VRSCDX handlebar. When combined with a Reach Seat P/N 52024-01 and Reach Control Kit P/N 50360-04, the VRSCDX model can be configured to provide a compact hand-seat-foot relationship for the shorter rider. Satin black handlebar complements the VRSCDX's dark side. Original Equipment on '12-'17 VRSCDX models.

57466-10 Satin Black. **\$99.95**
Fits '06-'08 VRSCD, and '07-'11 VRSCDX models. VRSCDX models require separate purchase of additional components.

57466-10 VRSCDX Black Reach Handlebar

'06-'08 VRSCD require:	Orig. Equipment Style
Clutch Lines	Stock
Throttle/Idle Cables	Stock
Brake Lines: Non-ABS	Stock
ABS models	Stock

'07-'11 VRSCDX require:	Orig. Equipment Style
Clutch Lines	Stock
Throttle/Idle Cables	56984-07, 56985-07
Brake Lines: Non-ABS	44736-06B
ABS models	42264-08A

VRSCD/VRSCDX HANDLEBAR COMPARISON

Handlebar P/N	Standard Bar	Reach Bar
	(OE VRSCDX shape) 56981-07	(OE VRSCD shape) 57466-10
Tip-to-Tip	30.50"	28.80"
Base Width	7.00"	7.00"
Pull Back	3.25"	6.25"
Rise (Tip-to-Base)	3.50"	5.70"
Knurl Center-to-Center	3.50"	3.14"
Bar Diameter	1.00"	1.00"

B. HAND CONTROL LEVER KIT

Continue the "blacked-out" or chrome theme with these Hand Control Levers. Cast from aluminum, these levers feature a custom finish designed to match the black or chrome hydraulic clutch components and Original Equipment-style hand controls.

Fits '06-'17 VRSC™ models.

42270-06B Chrome. **\$159.95**

42275-07A Black. **\$99.95**

Fits '02-'05 VRSC and '96-'06 Dyna®, Softail® and Touring models equipped with hydraulic clutch.

46114-07 Chrome. **\$119.95**



A. REACH HANDLEBAR – VRSCDX SHOWN



B. HAND CONTROL LEVER – CHROME
(42270-06B SHOWN)



B. HAND CONTROL LEVER – BLACK
(42275-07A SHOWN)



B. HAND CONTROL LEVER – CHROME
(46114-07 SHOWN)

*NOTE: Installation of some handlebars and risers may require a change in clutch and/or throttle cable and brake hose for some models. Handlebar height is regulated in many areas. Check local laws before installation.

Notice: The prices appearing in this catalog are the manufacturer's suggested retail prices. Actual retail prices may vary.



C. CHROME CLUTCH BRACKET AND MASTER CYLINDER RESERVOIR KIT

C. CHROME CLUTCH BRACKET AND MASTER CYLINDER RESERVOIR KIT

C. CHROME CLUTCH BRACKET AND MASTER CYLINDER RESERVOIR KIT

Replace your stock painted aluminum controls with brilliant chrome, without compromising quality. This kit is manufactured from the Original Equipment components and includes Chrome Master Cylinder Cover. When combined with Chrome Switch Housing Kit, Chrome Switch Caps and other Harley-Davidson® Genuine Motor Accessories, this front brake control kit provides a look that does more than stop your bike – it can stop traffic.

42100-06D Fits '06-'17 VRSC™ models. **\$639.95**

46112-02F **\$399.95**

Fits '02-'05 VRSC models. Also fits hydraulic clutch equipped '96-'05 Dyna® and Softail® and '96-'04 Touring models with dual disc front brakes.



C. CHROME CLUTCH BRACKET AND MASTER CYLINDER RESERVOIR KIT (42100-06D SHOWN)

C. CHROME CLUTCH BRACKET AND MASTER CYLINDER RESERVOIR KIT (46112-02F SHOWN)

D. SWITCH HOUSING KIT – CHROME

Convert your housings from black to chrome with this complete kit. Includes left, right, upper and lower housings. No switches or wiring required. Installation instructions included.

70222-96B **\$139.95**

Fits '02-'17 VRSC, '96-'13 XL, '08-'12 XR, '96-'11 Dyna and Softail (except FXSTDSE) and '96-'13 Road King® (except FLHRSE) models.

E. SWITCH CAP KIT – CHROME

Not satisfied until everything you see is chrome? This Chrome Switch Cap Kit will add style to one of the most visible areas of your bike, the switches. Shaped for the same ergonomic feel as the Original Equipment hand control switches, these caps replace the stock black caps without re-wiring. The chrome switch caps complement other chrome hand control accessories (Chrome Master Cylinder Kit, Chrome Hand Levers, Chrome Switch Housings and Chrome Master Cylinder Cover) to complete the custom look.

71804-03 **\$24.95**

Fits '02-'17 VRSC, '96-'13 XL and XR, '96-'11 Dyna, '96-'13 FLHR and '98-'01 FLHRC models. FLHR models equipped with Cruise Control use Kit P/N 71808-03.

F. FRONT MASTER CYLINDER COVER KIT – CHROME

Update the view over the handlebar with a touch of chrome. Kit includes left and right Master Cylinder Reservoir Covers and all necessary installation hardware.

42114-06A Fits '06-'17 VRSC models. **\$129.95**

G. FRONT MASTER CYLINDER COVER – CHROME

Includes one chrome-plated cover, gasket and decal. Easily installed with included stainless steel screws.

45078-96D **\$39.95**

Fits '02-'05 VRSC, '96-'03 XL, '96-'05 Dyna and Softail and '96-'04 Touring models.



D. SWITCH HOUSING KIT – CHROME

E. SWITCH CAP KIT – CHROME



F. FRONT MASTER CYLINDER COVER KIT – CHROME

G. FRONT MASTER CYLINDER COVER – CHROME

Notice: The prices appearing in this catalog are the manufacturer's suggested retail prices. Actual retail prices may vary.

38 V-ROD®

Foot Controls

A. SLOTTED SHIFT LEVER – SATIN BLACK

The high style of the VRSC™ model is reflected in this sweeping open-design shift lever. Available in satin black, the slotted billet design and integral molded rubber pad with Bar & Shield logo is a look that will get noticed. Install the matching Slotted Brake Lever for a complete look.

34551-09 **\$169.95**
Fits '02-'17 VRSC models (except VRSCD and VRSCR).

B. SLOTTED REAR BRAKE LEVER – SATIN BLACK

Styled to complement the lean and low look of the VRSC motorcycle, the open-slotted design of this brake lever adds a custom touch to your stock forward controls. Available in satin black, this Slotted Brake Lever includes a matching ribbed brake pedal pad with embossed Bar & Shield logo. Complete the look with a matching Slotted Shift Lever.

48983-09 **\$169.95**
Fits '02-'17 VRSC models (except VRSCD and VRSCR).

C. JIFFY STAND – CHROME

With this beautifully chrome-plated accessory, your VRSC™ model won't just stand on its own – it will stand out. Using the Original Equipment jiffy stand to ensure quality and fitment, this piece is polished and plated to decoratively enhance a very visual component on the vehicle. Reuses Original Equipment spring for installation.

49742-01A **\$99.95**
Fits '02-'17 VRSC models (except VRSCF and VRSCR).

D. ENGINE GUARD KIT*

Protect your Revolution® engine in style. The unique S-curve shape adds style to function. The Engine Guard features a two-piece design that allows for easy radiator service. Each side can be removed independently by simply removing two bolts.

Fits '02-'17 VRSC™ (except VRSCR) models. Will not fit with Regulator Cover P/N 74496-03 and 74497-03 or with VRSCSE Chin Fairing.

49267-01A Chrome. **\$309.95**
49388-09 Gloss Black. **\$309.95**



A. SLOTTED SHIFT LEVER – SATIN BLACK



B. SLOTTED REAR BRAKE LEVER – SATIN BLACK



C. JIFFY STAND – CHROME



D. ENGINE GUARD KIT – CHROME



D. ENGINE GUARD KIT – GLOSS BLACK



***WARNING:** Engine guards may provide limited leg and cosmetic vehicle protection under unique circumstances (fall over while stopped, very low speed slide). They are not made nor intended to provide protection from bodily injury in a collision with another vehicle or any other object.

Notice: The prices appearing in this catalog are the manufacturer's suggested retail prices. Actual retail prices may vary.



E. BRAIDED STAINLESS STEEL COOLANT LINE

F. OIL TEMPERATURE DIPSTICK

E. BRAIDED STAINLESS STEEL COOLANT LINE

Add the performance look that only braided steel can provide with this custom Coolant Line Kit. Complemented by machined billet aluminum chrome-plated end caps for exact fitment and flawless function.

26792-01 Fits '02-'17 VRSC™ models. **\$95.95**

F. OIL TEMPERATURE DIPSTICK

Replace your Original Equipment oil dipstick with this custom-styled version featuring an easy-to-see mechanical temperature readout with Harley-Davidson logo. A knurled, chrome-plated aluminum cap completes the styling and provides an easy grip for removal.

62962-01A **\$39.95**
Fits '02-'17 VRSC models (except VRSCF).

G. BILLET MUFFLER CLAMP KIT – CHROME

Complete the flowing lines of the VRSC™ mufflers with brilliant chrome. These highly polished and chrome-plated machined billet aluminum clamps provide the perfect finishing touch to the long and lean VRSC exhaust. These clamps replace the Original Equipment strap muffler clamps, are reusable and fit with the Original Equipment or Screamin' Eagle® Slip-On Mufflers.

65271-03 **\$104.95**
Fits '02-'10 VRSCA, VRSCAW, VRSCB and VRSCX models equipped with Original Equipment mufflers.



G. BILLET MUFFLER CLAMP KIT – CHROME

H. CHROME HARDWARE KIT – CAM COVER

Kit includes chrome washers and smooth socket head metric screws made to Harley-Davidson specifications. Kit includes the hardware required to replace the visible set of zinc-plated fasteners on the cam cover.

94014-03 Fits '02-'17 VRSC models. **\$39.95**

I. CHROME HARDWARE KIT – CLUTCH HOUSING AND WATER PUMP

Kit includes chrome washers and smooth socket head metric screws made to Harley-Davidson specifications. Kit includes the hardware required to replace the visible set of zinc-plated fasteners on the clutch cover, secondary clutch actuator cover and water pump cover.

94002-03 Fits '02-'17 VRSC models. **\$69.95**

Also available: (not shown)

CHROME HARDWARE KIT – ALTERNATOR COVER AND FRONT SPROCKET COVER

Kit includes chrome washers and smooth socket head metric screws made to Harley-Davidson specifications. Kit includes the hardware required to replace the visible set of zinc-plated fasteners on the alternator cover, derby cover and front sprocket cover.

94001-03 Fits '02-'17 VRSC models. **\$59.95**



H. CHROME HARDWARE KIT – CAM COVER

I. CHROME HARDWARE KIT – CLUTCH HOUSING AND WATER PUMP

Notice: The prices appearing in this catalog are the manufacturer's suggested retail prices. Actual retail prices may vary.



IRON 1200™

SPORTSTER® | XL1200NS | VIVID BLACK

Love isn't in the air — it's on the streets. Loaded with low-end torque and top-end scoot, this Iron 1200™ motorcycle has it all. With its blacked-out engine, piggyback shocks and classic café racer style clip-on bars, you'll fall in love every time you ride.



Clip-On Handlebar/Bar End Mirrors.....p 56 & 57



5 3/4" Headlamp Trim Ring (Gloss Black).....p 728



Screamin' Eagle® Piggyback Shocks.....p 87



Instrument Cluster/Speedo Relocation Kit.....p 57



SUPERLOW®

SPORTSTER® | XL883L | VIVID BLACK

Sometimes you have to get low to reach new highs. With its low Reach® seat, this SuperLow® motorcycle is the easy-to-ride motorcycle of your dreams. Throw in some interchangeable trim pieces, an LED headlamp and aggressive-sounding slip-on mufflers, and you'll be riding high every time you ride.



Screamin' Eagle® Street Cannon Slip-On Mufflers (Jet Black) ...p501



Super Reach® Solo Seat p 66



Dominion™ Hand Grips (Black) p 580



Dominion™ Rider Footpeg/Shifter Peg (Black)..... p 580



IRON 883™

SPORTSTER® | XL883N | RAWHIDE DENIM

Like a world champion cage fighter, this Iron 883™ motorcycle is ready to take on whatever the road can dish out. And with its Chizeled Lo Handlebar, solo saddle and bronze accents, it's the only bike that's fully capable of kicking ass and taking names.



Chizeled Lo Handlebar (Gloss Black)..... p636



Black Diamond Solo Saddle.....p70



19" Dunlop® Front Tire (Whitewall) p852



Screamin' Eagle® Exhaust p501

BREAKFAST
DINNERS

SANDWICHES
LUNCHES



1200 CUSTOM

SPORTSTER® | XL1200C | SILVER FLUX & BLACK FUSE

Whoever said you have to suffer for fashion has never taken to the open road on a 1200 Custom. With its chrome wheels, solo seat with rider backrest and quick-release windshield, comfort has never looked or felt so good.



Signature Series® Solo Seat With Rider Backrest p 67



Black Standard Line Throw-Over Saddlebags — Compact...p 84



Airflow Heated Hand Grip (Chrome)..... p 606



Quick-Release Windshield..... p 62



ROADSTER™

SPORTSTER® | XL1200CX | BILLIARD WHITE

Show the pavement who's boss with the Harley-Davidson® Roadster™ motorcycle. Hopped up with Stage IV power, rear set foot controls and a performance exhaust that sounds as sweet as it looks, this Roadster™ leaves no question who's in charge.



Engine — Rail Collection..... p.558



Defiance Hand Grips (Black) p.588



Super Sport Quick-Release Windshield.....p.63



Color-Matched Café Custom Tail Sectionp.55



FORTY-EIGHT®

SPORTSTER® | XL1200X | INDUSTRIAL GRAY

Like a 40-oz. can of whoop-ass waiting to be cracked open, this Forty-Eight® motorcycle is the heavy-hitting champion of style. From its mini-apes and slammed solo seat to its brass accents and gloss black sissy bar, it's ready to deliver a powerful punch of classic bobber style.



Single-Sided Swingarm Bag.....p85



Bobber Solo Saddle p70



Brass Collection Derby Cover..... p 538



Detachable Sissy Bar Upright (Gloss Black) p 75



FORTY-EIGHT® SPECIAL

SPORTSTER® | XL1200XS | WICKED RED

Like your favorite poster of a '70s model, you just can't stop looking at it. With its throwback '70s tank art, solo seat and chromed-out engine, this Forty-Eight® Special motorcycle is nothing short of retro perfection.



Café Solo Seat.....p68



Drag Bar..... p634



Turn Signal Lens Kit — Smoked..... p733



Airflow Hand Grips (Black) p599

CAFÉ CUSTOM

A Café bike starts with a “less-is-more” philosophy. Low-slung bars, rear-set foot controls and a narrow profile define the style. And when stripped of all “unnecessary” accessories, these unburdened motorcycles are lighter, faster and have a harder-edged, rebellious look that reflects the rider’s bare-knuckle attitude.



This Iron 883™ model is caffeine fueled, fully wired, and ready to carve up back roads. Equipped with a suite of Café Custom components and a Screamin' Eagle® fully adjustable suspension, this aggressive riding profile puts you firmly in control.

1 CLIP-ON BARS

Low, narrow clip-on handlebars enable the rider to “tuck in,” helping to reduce wind resistance and improve control.

2 BAR END MIRRORS

Bar End Mirrors provide a clean, streamlined look, and the outside-the-grip location eases the view past your hands and shoulders.

3 REAR SET CONTROLS

For the ultimate in aggressive riding posture, Rear Set Foot Controls reposition your feet to encourage a tank-hugging profile.

4 CAFÉ TAIL SECTION

This fast-back solo seat provides the perfect lay-down aggressive riding posture for splitting lanes or carving corners.



A. CAFÉ CUSTOM TAIL SECTION – VIVID BLACK



A. CAFÉ CUSTOM TAIL SECTION – WICKED RED



A. CAFÉ CUSTOM TAIL SECTION – UNPAINTED

A. CAFÉ CUSTOM TAIL SECTION –
COLOR-MATCHEDB. LICENSE PLATE BRACKET KIT CANADA
MODELS

B. LICENSE PLATE BRACKET KIT HDI MODELS

A. CAFÉ CUSTOM TAIL SECTION

Create your own link to the Sportster®-based racing and performance bikes of the '60s and '70s. This fast-back solo seat and tail section mirrors the look and feel of the iconic 1977-78 Harley-Davidson® XLCR Café Racer model, and re-imagines the style for the modern era. Ideal for use with Clip-On or Sportster Clubman Handlebars and mid- or rear-set foot controls, this seat provides the perfect lay-down aggressive riding posture for splitting lanes or carving corners. The seat's upturned tail and longer nose positions the solo rider closer to the tank for better weight balance, quicker steering and added front-end feedback. The Tail Section is a true bolt-on design that wraps the fender struts, so unlike other café bike kits, there is no cutting, welding or frame modifications required. Installation is reversible – you can easily return your bike to the stock look. The complete kit features a sweeping composite tail section with a steel inner support, a deep solo bucket seat with backstop pad, and all necessary installation hardware.

Fits '10-later XL883N, XL1200CX, XL1200N, XL1200NS, XL1200V, XL1200X and XL1200XS models. Separate purchase of License Plate Bracket Kit P/N 67900360 for Canada models or P/N 67900359 for HDI models is required.

59500644	Unpainted.	\$574.95
59500560ELM	Billiard White.	\$749.95
59500560BYM	Black Denim.	\$749.95
59500560ELE	Blue Max.	\$799.95
59500560EFW	Bonneville Salt Denim.	\$749.95
59500560EEP	Chameleon Flake (HCC).	\$849.95
59500689EGB	Electric Blue/Silver Fortune.	\$799.95
59500560EEZ	Industrial Gray.	\$749.95
59500560EFC	Industrial Gray Denim.	\$749.95
59500689EGL	Industrial Gray Denim/Black Denim.	\$799.95
59500560EEL	Legend Blue Denim.	\$799.95
59500560EKN	Rawhide Denim.	\$749.95
59500560EKI	Rugged Gold Denim.	\$749.95
59500786ELF	Scorched Orange/Black Denim.	\$799.95
59500560EEO	Shattered Flake (HCC).	\$849.95
59500786ELH	Silver Flux/Black Fuse.	\$799.95
59500560EFD	Sumatra Brown.	\$749.95
59500560EFH	Twisted Cherry.	\$749.95
59500560DH	Vivid Black.	\$699.95
59500560EFF	Wicked Red.	\$749.95
59500560EKG	Wicked Red Denim.	\$749.95

B. LICENSE PLATE BRACKET KIT

Required for installation of Café Custom Tail Section P/N 59500644 or 59500560DH on models in specific International markets.

Fits '07-later XL883N, XL1200CX, XL1200N, XL1200NS, XL1200V, XL1200X and XL1200XS models equipped with Café Custom Tail Section.

67900360	Canada Models.	\$149.95
67900359	HDI Models.	\$49.95

Notice: The prices appearing in this catalog are the manufacturer's suggested retail prices. Actual retail prices may vary.

56 SPORTSTER®

Café Custom Accessories

A. CLIP-ON HANDLEBAR KIT – GLOSS BLACK*

Mounted on the fork tubes below the upper triple tree, these Clip-On Handlebars place the rider in a low and aggressive tank-hugging riding posture. Ideal for carving corners and splitting lanes, these Clip-On bars narrow the overall width of the bike and keep the rider tightly tucked into the machine for a "one-with-the-bike" feeling. Fully adjustable for reach and height, these individual 12.25" bars are engineered from solid aluminum for strength, and drilled and dimpled to accept bar-end mirrors and standard hand controls. The beefy gloss black bars are secured to the fork tubes with precision-machined clamps and aircraft grade hardware. Kit includes bars, fork clamps and all mounting hardware. Individual vehicle applications may require separate purchase of instrument mount and cables or brake lines.

55800647 39mm Fork. **\$249.95**
Fits '14-later XL883N, XL1200C, XL1200NS and '07-'15 XL1200X models with 39mm forks. Does not fit with Heated Hand Grips. Not compatible with Headlamp Visor P/N 68129-97 or 68129-98DH. All models may require separate purchase of additional components. 1200X models require separate purchase of Round Bar End or high-mounted stem mirrors.

55800668 49mm Fork. **\$249.95**
Fits '16-later XL1200X and XL1200XS models with 49mm forks. Does not fit with Heated Hand Grips. All models may require separate purchase of additional components. 1200X models require separate purchase of Round Bar End or high-mounted stem mirrors.

55800646 55mm Fork. **\$249.95**
Fits '16-later XL1200CX models with 55mm forks. Does not fit with Heated Hand Grips. All models may require separate purchase of additional components.

See your Dealer for cables, lines and additional installation components required, or visit www.H-D.com/store and search part number 55800647, 55800668 or 55800646.

B. SPORTSTER® CLUBMAN HANDLEBAR*

Be prepared to attract a lot of attention. Designed to replicate the look and posture of clip-on bars, this 1" Clubman Handlebar is shaped to drop the grips below the top triple tree to provide a tank-hugging aggressive riding position. The Sportster® Clubman bar can also be rotated forward to create an arms-out stance. The bar is enabled for internal wiring for a clean look.

55800342 Satin Black. **\$199.95**
Fits '10-later XL models (except '11-later XL883L). Does not fit with Heated Hand Grips. All models require separate purchase of additional installation components.

See your Dealer for cables, lines and additional installation components required, or visit www.H-D.com/store and search part number 55800342.



A. CLIP-ON HANDLEBAR KIT – GLOSS BLACK



B. SPORTSTER CLUBMAN HANDLEBAR – SATIN BLACK

*NOTE: Installation of some handlebars and risers may require a change in clutch and/or throttle cable and brake lines for some models. Handlebar height is regulated in many areas. Check local laws before installation.

Notice: The prices appearing in this catalog are the manufacturer's suggested retail prices. Actual retail prices may vary.



C. INSTRUMENT MOUNTING BRACKET

**C. INSTRUMENT MOUNTING BRACKET**

Required for installation of Clip-On Handlebars on XL1200C and XL1200CX models. Gloss black mounting bracket repositions the speedometer for optimum viewing angle, and fills the Original Equipment handlebar riser mounting location for a clean look.

70900660 **\$169.95**
Fits '14-later XL 1200C and XL1200CX models.

D. INSTRUMENT AND HEADLAMP MOUNTING BRACKET

Required for installation of Clip-On Handlebars on XL883N models. Gloss black mounting bracket fills the Original Equipment handlebar riser mounting location for a clean look and replaces the factory instrument mount and headlamp visor to lower the gauge for an improved viewing angle with clip-on bars.

70900661 **\$259.95**
Fits '14-later XL883N and XL1200NS models.



D. INSTRUMENT AND HEADLAMP MOUNTING BRACKET

**E. HANDLEBAR CLAMP FILLER PLUG**

Recommended for installation of Clip-On Handlebars on XL1200X models. The Plug Kit fills the Original Equipment handlebar riser for a clean look.

55800672 **\$24.95**
Fits '14-later XL1200X and XL1200XS models.

F. ROUND BAR END MIRROR – SATIN BLACK*

Complete the cut-down Café bike look. These Bar End Mirrors provide a clean, streamlined look when compared to traditional mirrors. These round convex mirrors plug into the end of the handlebar to extend beyond the hand grip for an improved field of view on the bike equipped with narrow bars. When equipped with the Bar End Mirror Hand Grips (sold separately), the mirrors are simply inserted into the end of the grip and tightened in place. The mirrors are adjustable for maximum rear visibility, and can be positioned above the bar or, in some configurations, below the bar. When positioned below the bar, the left hand mirror is used on the right, and the right hand mirror moves to the left side. Includes hardware required to fit both 7/8" or 1" bars. Right and left mirrors are sold separately.

Fits stock or accessory handlebars on '15-later XG (except models equipped with Drag Bar P/N 55800225 or 55800238), '02-'17 VRSC™ (except VRSCF), '96-later XL and XR, '96-'17 Dyna® (except FXDLS), '96-'15 Softail® (except FLSTNSE, FXSBSE and '11-'12 FLSTSE) and '96-'07 Touring models. Installation requires separate purchase of Diamond-Black Hand Grip P/N 56100199 (1") or 56100202 (7/8").

56000133 Right Hand (upright position). **\$99.95**
56000134 Left Hand (upright position). **\$99.95**

G. DIAMOND-BLACK HAND GRIPS – BAR END MIRRORS

Shroud your bike in mystery. This blacked-out hand and foot control collection features distinctive knurled surfaces that expose the raw billet aluminum for a dramatic contrast. Designed to age and "break-in" like a pair of comfortable stone-washed jeans, the satin black finish will complement both high-gloss and denim paint colors. Designed for use with Bar End Mirrors, these stripped-down Hand Grips feature glueless installation that can be easily removed for service without damage. Grip End Caps are sold separately.

56100199 For 1" Diameter Bar. **\$99.95**
Fits '02-'17 VRSC (except VRSCF), '96-later XL and XR, '96-'17 Dyna (except FXDLS), '96-'15 Softail (except FLSTNSE, FXSBSE and '11-'12 FLSTSE) and '96-'07 Touring models. Installation requires separate purchase of Bar End Mirrors P/N 56000133 and 56000134 or End Caps P/N 55900114.

Also available:**HAND GRIP END CAPS**

Easy to install smooth End Caps fill the open end of the Diamond-Black Bar End Mirror Hand Grips if you remove the mirrors or select to use only a single mirror. Sold individually.

55900114 **\$15.95**
Fits models equipped with Diamond-Black Hand Grips P/N 56100199 and 56100202.



E. HANDLEBAR CLAMP FILLER PLUG



F. ROUND BAR END MIRROR – SATIN BLACK



G. DIAMOND-BLACK HAND GRIPS – BAR END MIRRORS

*Harley-Davidson Motor Company cannot test and make specific fitment recommendations concerning every possible mirror and handlebar combination. Therefore, after installing new mirrors or handlebars, and before operating the motorcycle, check to ensure that the mirrors provide the operator a clear view to the rear.

Notice: The prices appearing in this catalog are the manufacturer's suggested retail prices. Actual retail prices may vary.

58 SPORTSTER®

Café Custom Accessories

A. REAR SET FOOT CONTROLS – SPORTSTER® MODELS

Transform the on-street profile of your Sportster® model. Moving the foot controls to a rear-mounted location takes the riding position from a relaxed cruiser to a solo, aggressive, curve-carving posture. When combined with a Clip-On or Clubman Handlebar, the resulting hands-forward and feet-back profile drapes the rider over the bike and makes you feel a part of the machine. This complete gloss black Rear Set Control Kit includes everything you need to move the brake and shift lever to the rear passenger position. This unique kit maintains the standard 1-down and 4-up shift pattern, and can be installed with the Original Equipment low staggered exhaust system. Kit reuses Original Equipment rider footpegs. Installation requires removal of passenger footpegs and footpeg mounts. For solo rider application only.

50700040 Gloss Black. **\$724.95**
 Fits '14-later XL883N, XL883L, XL1200CX, XL1200T, and XL1200X models and '18-later XL1200NS and XL1200XS models. Does not fit with Rail Collection Sprocket Cover P/N 34800032. For use with solo seat application only. Installation of Rear Set Controls requires removal of passenger foot pegs, therefore removal of the Original Equipment two-up seat and installation of a solo-only seat is required. See your Dealer for solo seat options.

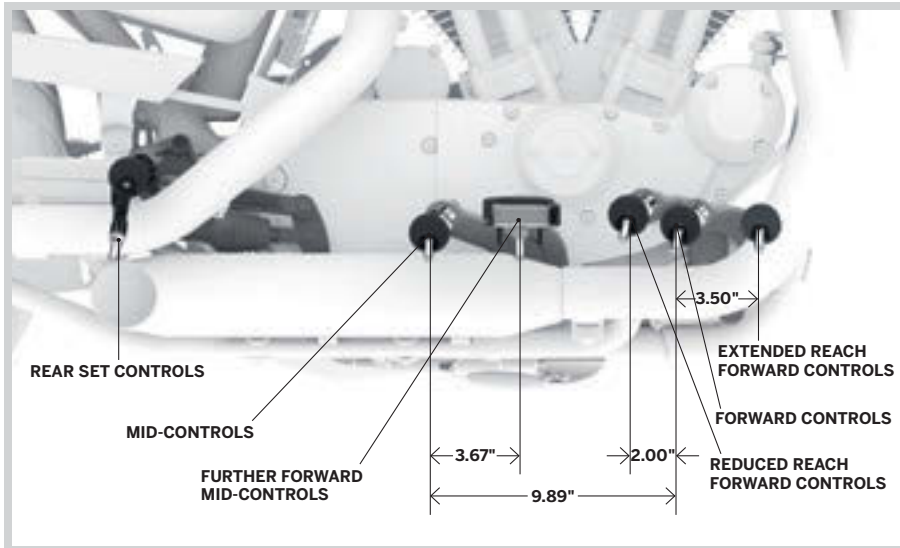

FOOT CONTROL POSITION OPTIONS



A. REAR SET FOOT CONTROLS – SPORTSTER MODELS



A. REAR SET FOOT CONTROLS KIT GLOSS BLACK – SPORTSTER MODELS

Notice: The prices appearing in this catalog are the manufacturer's suggested retail prices. Actual retail prices may vary.



B. TANK KNEE PAD KIT

B. TANK KNEE PAD KIT

These self-adhesive rubber knee pads provide a touch of old school style. The rich black rubber pads feature tapered ribs and a raised Bar & Shield logo to protect the surfaces where your legs contact the tank. The compact pads measure 7.0" by 2.75", and are flexible enough to fit many tank profiles. Sold in matched pairs.

57300065 \$39.95

Fits fuel tanks on many Street™, Sportster®, Dyna® and Softail® models. May cover a portion of fuel tank graphics. Check appearance before adhering to tank.

C. CUT BACK SIDE COVERS

Instantly transform the profile of your Sportster motorcycle. These Cut Back Side Covers feature a unique two-piece design with a cutaway, technical look. The combination of gloss black and textured black surfaces visually reduces the size of the side covers, and the raised "speed lines" impart a sense of forward motion. The side covers feature improved mounting tabs for easy and secure installation. Right-side oil tank cover features a gloss black dipstick surround to add to the blacked-out look. Oil Tank Cover and Battery Cover are sold individually.

Fits '14-later XL models.

57200139 Oil Tank Cover. **\$149.95**

57200140 Battery Cover. **\$149.95**

D. DIPSTICK BEZEL – GLOSS BLACK

This gloss black Dipstick Bezel replaces the Original Equipment chrome or satin silver bezel and completes the blacked-out look of the Sportster® model's right side oil tank cover. This bezel complements the available Gloss Black LCD Oil Level and Temperature Dipstick P/N 62700011. Includes replacement push nut for installation.

57200159 \$19.95

Fits '04-later XL models.

E. SPORTSTER® FRONT SPOILER*

The wedge shape of the spoiler accents the lean and narrow look of the Sportster® model. Injection-molded from high-impact material and available Primed or Vivid Black finishes. Kit includes all mounting hardware.

Fits '04-later XL models. Does not fit with Engine Guards, Boom!™ Audio Cruiser Amp and Speakers or Down Tube Bags.

58882-04BDK Primed. **\$179.95**

58882-04DH Vivid Black. **\$249.95**



C. CUT BACK OIL TANK COVER



C. CUT BACK BATTERY COVER



D. DIPSTICK BEZEL – GLOSS BLACK



E. SPORTSTER FRONT SPOILER – VIVID BLACK

*NOTE: This product is a "Paint to Order" accessory. Please allow for an average of 5 weeks delivery for this item.

Notice: The prices appearing in this catalog are the manufacturer's suggested retail prices. Actual retail prices may vary.

DEFY THE WIND

At highway speed, you take the wind full-force in the chest, causing fatigue in your arms, neck and shoulders. Take the pressure off with an easy-to-install detachable windshield. Shaped to divert air, rain and road debris around the rider, a windshield can add hours of riding comfort.

KEEPING YOU COVERED

20.1 IN

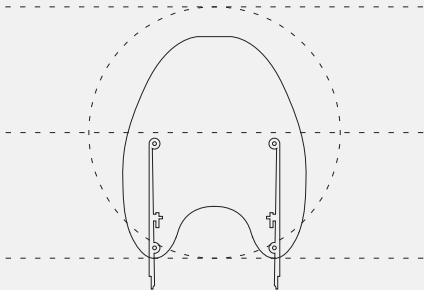

SUPER SPORT

Eliminates wind and debris, but keeps the wind-in-the-hair feeling. Ideal for a cool morning ride to the office, the sleek profile hugs the front lamps for a sporty look.

19.5 IN

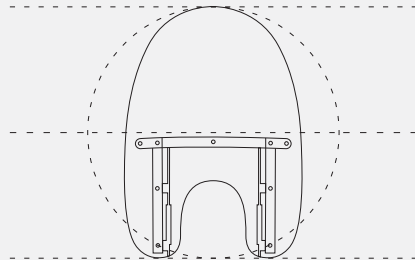

COMPACT

Traditional king-sized shape with a minimalist edge. For Harley-Davidson® custom and cruiser models, the Compact windshield provides wind and weather protection for every-day riding.

22.1 IN

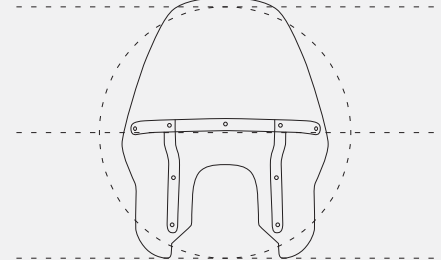

TOURING

Add maximum weather protection to your sporting motorcycle. Contoured to divert the wind around the rider's helmet and hands, a Touring windshield means long-ride comfort.

READY FOR TAKE-OFF

Designed to be installed or removed without tools in seconds, a detachable windshield gives you the freedom to define your ride at the drop of a hat. Ride across the country protected from the elements, then quickly remove the windshield to hit the streets in style.



To avoid looking through bug spots, condensation and road grime, select a windshield that tops out just below your line of sight.

SCRATCH-RESISTANT
HARD-COATED
POLYCARBONATE SHIELD

NO TOOLS
QUICK-RELEASE
MOUNT

STAINLESS STEEL
BRACKETS & BRACES





A. COMPACT SPORT WIND DEFLECTOR

A. COMPACT SPORT WIND DEFLECTOR

Shaped to smooth the wind flow around the headlamp and handlebar mount gauges, this compact bikini screen is the ideal addition to your ride. Sitting just above the headlamp, the Compact Wind Deflector maintains the stripped-down minimalist attitude of the Sportster® motorcycle while adding a clean, custom look. The easy-to-install dark polycarbonate screen attaches to the fork tubes with chrome-plated adjustable clamps. Kit includes all mounting hardware.

57400184**\$249.95**

Fits '04-later XL models (except '11-later XL1200C, XL1200CX, '16-later XL1200X and '18-later XL1200XS). XL1200NS requires removal of headlight visor.

B. QUICK-RELEASE SUPER SPORT WINDSHIELD

Reduces the pounding of wind and shower of bugs, but keeps the wind-in-the-hair feeling. Ideal for a cool morning ride, the sleek profile of the Super Sport Windshield hugs the front headlamp for a sporty look. The windshield mounts to the fork tubes with elegant die-cast lever locking clamps, so the windshield does not require any leave-behind docking hardware. You get quick on-and-off convenience and a clean, custom look. No tools are required and the kit includes everything needed to install the windshield.

57838-08 19" Light Smoke.**\$324.95**

Fits '88-later XL (except XL1200CX, XL1200T, XL1200X, XL1200XS and '11-later XL883L and XL1200C). XL1200NS requires removal of headlight visor. Also fits '91-'05 Dyna® models (except FXDWG and FXDXT). XL Custom models require Front Directional Relocation Kit P/N 68517-94A.

Windshield dimensions: Overall height – 25.0"; width – 20.1".



B. QUICK-RELEASE SUPER SPORT WINDSHIELD

62 SPORTSTER®

Windshields

A. QUICK-RELEASE COMPACT WINDSHIELD

Combine the classic Harley-Davidson® windshield shape with a revolutionary new attachment system and you have the best of style and function. The windshield mounts to the fork tubes with elegant die-cast lever-release clamps, so the windshield does not require any leave-behind docking hardware. You get quick on-and-off convenience and a clean, custom look. No tools are required and the kit includes everything needed to install the windshield. The tough, hard-coated polycarbonate windshield is available with traditional polished or gloss black horizontal and vertical braces.

Fits '88-later XL (except XL1200CX, XL1200T, XL1200X, XL1200XS and '11-later XL883L and XL1200C), XL1200NS requires removal of headlight visor. Also fits '91-'05 Dyna® models (except FXDWG and FXDXT).

58063-04 18" Clear – Polished Braces. **\$369.95**
Windshield dimensions: Overall height – 26.8"; width – 19.7".

58706-09 18" Clear – Black Braces. **\$389.95**
Windshield dimensions: Overall height – 26.8"; width – 19.7".

58602-04 14" Light Smoke – Polished Braces. **\$374.95**
Windshield dimensions: Overall height – 22.8"; width – 19.5".

58703-09 14" Light Smoke – Black Braces. **\$394.95**
Windshield dimensions: Overall height – 22.8"; width – 19.5".

Fits '11-later XL883L and XL1200C and '14-'17 XL1200T models.

57801-11 18" Clear – Polished Braces. **\$369.95**
Windshield dimensions: Overall height 26.8"; width 19.7".

57802-11 14" Light Smoke – Polished Braces. **\$374.95**
Windshield dimensions: Overall height 22.8"; width 19.5".

Fits '10-'15 XL1200X models.

58053-10 19" Clear – Black Braces. **\$379.95**
Windshield dimensions: Overall height 24.0"; width 19.5".

57682-10 15" Light Smoke – Black Braces. **\$379.95**
Windshield dimensions: Overall height 20.0"; width 19.5".

Fits '16-later XL1200X and XL1200XS models.

57400318 19" Clear – Black Braces. **\$394.95**

57400319 15" Light Smoke – Black Braces. **\$399.95**

B. QUICK-RELEASE TOURING WINDSHIELD

The Touring Windshield features an aerodynamic design shaped to provide hours of riding comfort. The additional center width directs airflow past the hand grips and deflects rain and road debris around the rider. The windshield mounts to the fork tubes with elegant die-cast lever-release clamps, so the windshield does not require any leave-behind docking hardware. You get quick on-and-off convenience and a clean, custom look. No tools are required and the kit includes everything needed to install the windshield. The tough, hard-coated polycarbonate windshield features traditional chrome horizontal and vertical braces.

58158-08 19" Clear. **\$439.95**

Fits '88-later XL (except XL1200CX, XL1200T, XL1200X, XL1200XS and '11-later XL883L and XL1200C), XL1200NS requires removal of headlight visor. Also fits '91-'05 Dyna models (except FXDWG and FXDXT). Windshield dimensions: Overall height – 28.3"; width – 22.1".



A. QUICK-RELEASE COMPACT WINDSHIELD – (GLOSS BLACK BRACES SHOWN)



B. QUICK-RELEASE TOURING WINDSHIELD

Notice: The prices appearing in this catalog are the manufacturer's suggested retail prices. Actual retail prices may vary.



C. H-D DETACHABLES COMPACT WINDSHIELD FOR MODELS WITH AUXILIARY LIGHTING

**C. H-D® DETACHABLES™ COMPACT WINDSHIELD FOR MODELS WITH AUXILIARY LIGHTING**

Whether it's for keeping bugs off your face or warmth in your body, a windshield has a huge impact on rider and passenger comfort. By diverting air pressure past your chest and over your helmet, a windshield can add hours of riding comfort. This high-quality polycarbonate windshield mounts to the fork tubes with detachable Docking Hardware for easy on-and-off convenience and a quick return to a stripped-down profile and is shaped to fit models equipped with Auxiliary Lighting Kits.

57400053 18" Clear. **\$289.95**

Fits '11-later XL883L models. Also for use on '11-later XL883L Police models equipped with pursuit lamps. Requires the separate purchase of Docking Hardware Kit P/N 58164-96A and Turn Signal Relocation Kit P/N 68603-01. Windshield dimensions: Overall height – 22.7"; width – 19.5".

57716-01 18" Clear. **\$289.95**

Fits '88-later XL (except XL1200CX, XL1200T, XL1200X, XL1200XS and '11-later XL883L and XL1200C). XL1200NS requires removal of headlight visor. Also fits '91-'05 Dyna® models (except FXDWG and FXDXT) equipped with Auxiliary Lamps. Requires the separate purchase of Docking Hardware Kit P/N 58164-96A and Turn Signal Relocation Kit P/N 68603-01. Windshield dimensions: Overall height – 26.8"; width – 19.7".

Shown with:

DOCKING HARDWARE FOR H-D DETACHABLES WINDSHIELDS

Each kit includes polished clamps and all required mounting hardware.

58164-96A **\$79.95**

Required for installation of H-D® Detachables™ windshields on '88-later XL (except XL1200CX, XL1200X and '11-later XL1200C) and '91-'05 Dyna models (except FXDWG and FXDXT). XL and Dyna models with front turn signals originally located on the upper triple clamp may require the additional purchase of Turn Signal Wiring Kit P/N 72389-96.

D. SPORT WINDSHIELD KIT

Formed of polycarbonate and hard-coated to resist scratching. Light smoke windshield is contoured to fit the headlamp and incorporates adjustable four-point mounting. Functional styling helps deflect wind to reduce upper body fatigue.

58192-87A 18" Light Smoke. **\$164.95**

Fits '88-later XL (except XL883C, XL1200C, XL1200CX, XL1200T, XL1200X, XL1200XS and '11-later XL883L). XL1200NS requires removal of headlight visor. Also fits '95-'05 Dyna® models (except FXDWG and FXDXT). Includes black mounting hardware. Windshield dimensions: Overall height – 18.5"; width – 16.3".

58024-96A 17" Light Smoke. **\$179.95**

Fits '96-'10 XL883C and XL1200C, '10 XL1200X, '99-'00 FXR and '87-'94 FXLR models. Windshield dimensions: Overall height-19.1"; width-16.3".

E. QUICK-RELEASE SUPER SPORT WINDSHIELD

Reduces the pounding of wind and shower of bugs but keeps the wind-in-the-hair feeling. Ideal for a cool morning ride, the sleek profile of the Super Sport Windshield hugs the front headlamp for a sporty look. The windshield mounts to the fork tubes with elegant die-cast lever locking clamps, so the windshield does not require any "leave-behind" docking hardware. You get quick on-and-off convenience and a clean, custom look. No tools are required and the kit includes everything needed to install the windshield.

57400345 11" Gradient. **\$349.95**

Fits '16-later XL1200CX models.

57262-08 11" Gradient. **\$344.95**

Fits '08-'13 XR1200™ models. Windshield dimensions: Overall height – 13.8"; width – 12.8".



D. SPORT WINDSHIELD KIT – (58192-87A SHOWN)



D. SPORT WINDSHIELD KIT – (58024-96A SHOWN)



E. QUICK-RELEASE SUPER SPORT WINDSHIELD –XL1200CX



E. QUICK-RELEASE SUPER SPORT WINDSHIELD – XR1200

64 SPORTSTER®

Windshields

A. H-D® DETACHABLES™ QUARTER FAIRING KIT

Sleek, racy styling and sweeping lines are the make-up of this innovative fairing. Its quarter-sized, detachable design gives your bike a whole new, sporty look that can be changed in an instant. Available in Primed or Vivid Black. Requires the installation of Detachable Docking Hardware Kit P/N 58164-96A.

Fits '88-'16 XL (except XL883C, XL883N, XL1200C, XL1200CX, XL1200N, XL1200T, XL1200V and XL1200X and '11-later XL883L), FXR and '95-'05 Dyna® models (except FXDWG, FXDXT and FXLR).

57070-98 Primed. **\$279.95**

57070-97DH Vivid Black. **\$399.95**



A. H-D DETACHABLES QUARTER FAIRING KIT



B. HEADLAMP VISOR

B. HEADLAMP VISOR

Add an element of racy style to stock headlamps with these visors, available in Primed or Vivid Black.

Fits '95-later XL models (except XL883C, XL1200C, XL1200CX, XL1200V, XL1200X and XL1200XS), '95-'05 Dyna models (except FXDWG and FXDXT), '82-'94 FXR and FXRS models. Does not fit with Clip-On Handlebar P/N 55800647.

68129-97 Primed. **\$139.95**

68129-98DH Vivid Black. **\$249.95**

C. FRONT TURN SIGNAL RELOCATION KIT

Moves the Original Equipment bullet directional lamps from the upper to the lower triple tree for a low-profile slammed look. Relocation is required for installation of Sportster Clubman and Drag Handlebars on Sportster® XL1200X models. Kit includes left and right mounts.

67800452 Satin Black. **\$39.95**

Fits '10-'15 XL1200X models.

67800557 Gloss Black. **\$99.95**

Fits '16-later XL1200X and XL1200XS models.



C. FRONT TURN SIGNAL RELOCATION KIT



D. FRONT TURN SIGNAL RELOCATION KIT

This kit includes the required hardware and wiring to move the front directional lamps from the handlebar to the lower triple clamp.

Fits '88-later XL (except XL1200CX, XL1200T, XL1200X, XL1200XS and '11-later XL883L and XL1200C) and '91-'05 Dyna models (except FXDWG and FXDXT).

68517-94A Chrome. **\$39.95**

68643-09 Gloss Black. **\$34.95**



D. FRONT TURN SIGNAL RELOCATION KIT



E. LOCKING QUICK-RELEASE WINDSHIELD CLAMP

E. LOCKING QUICK-RELEASE WINDSHIELD CLAMP

Protect your investment. This Locking Quick-Release Windshield Clamp secures your windshield from grab-and-run theft, giving you peace of mind when you have to leave your bike unattended. The chrome-plated Locking Clamp replaces one of the Original Equipment windshield clamps and features a push-button lock with a mini barrel-style key for easy removal. Kit includes one locking clamp and two matching keys.

57400006 39mm. **\$41.95**

Fits '88-later XL (except '16-later XL1200CX, XL1200X and XL1200XS) and '91-'05 Dyna models (except FXDWG) equipped with Quick-Release Style windshields.

57400008 49mm. **\$41.95**

Fits '02-'10 VRSCA and VRSCAW, '04-'05 VRSCB, '07 VRSCX, '16-later XL1200X and '06-later Dyna models (except FLD) equipped with Quick-Release style windshields.

Notice: The prices appearing in this catalog are the manufacturer's suggested retail prices. Actual retail prices may vary.

ENJOY THE RIDE

The relationship between the seat, the handlebar and the foot controls has an enormous impact on the comfort, control, and confidence you feel when riding your motorcycle. Once you've picked the bike, it's time to choose the options that match your ride to your personal dimensions.



For shorter riders, consider tailoring your fit by changing to a Reach® Seat, Mid-Foot Controls, and lowered suspension height.



For taller riders, consider altering your ride by changing to a Tallboy® Seat and Extended Foot Controls.

ESTABLISH YOUR POSITION AND FEEL

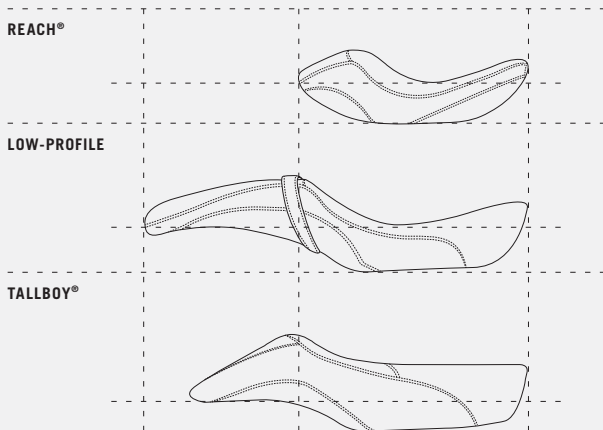

SEATS

Seat height and shape impact rider comfort, fit and confidence. Where the seat positions you relative to the foot controls, hand controls and the ground plays a major role in the quality of your ride.

SEE PAGES 66-71

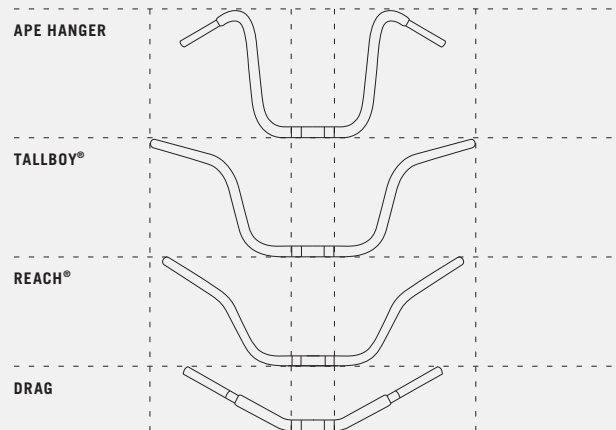

HANDLEBARS

Where the bar positions your arms, hands and wrists directly impacts how you feel on the motorcycle. Choose a bar that falls easily to hand, and does not pull you out of the seat when maneuvering.

SEE PAGES 636-639

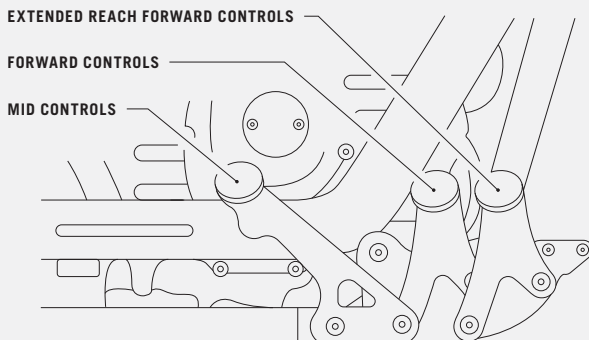

FOOT CONTROLS

Repositioning your feet can relieve muscle tension, take pressure off the tailbone and reduce fatigue. The correct riding position can add hours of comfort and hundreds of miles to your daily saddle time.

SEE PAGES 89-92, 580-613

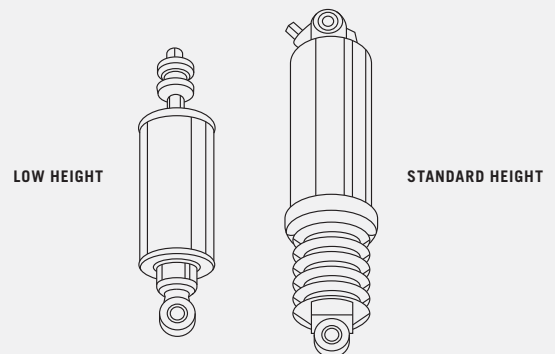

SUSPENSION

Adjusting your motorcycle's ride height by raising or lowering the suspension is often the first step in fitting the bike to your stature.

Being sure-footed at a stop can really increase your sense of confidence.

SEE PAGES 87-88

66 SPORTSTER®

Seating – Reach® & Tallboy®

A. SUPER REACH® SOLO SEAT

Get a little bit closer. Super Reach® forward position seats are designed to move riders with a shorter inseam even closer to the controls and to bring the legs closer together so that your feet rest firmly on the pavement. After hundreds of hours of on-road and ergonomic testing, the seat shape and foam density were selected as the ideal position for riders 5'-0" to 5'-4" tall. The Super Reach Seat moves the rider 1.5" closer to the controls compared to stock seat on XL883L model, and 2" closer and .5" lower compared to stock seat on XL1200C model. The nose is 1.0" narrower than the stock seat, and it is tastefully sculpted to look great with any size Sportster® fuel tank. The combination of premium textured and smooth vinyl surfaces and charcoal gray stitching and embroidered Bar & Shield logo really set the seat apart. For the ultimate solo touring setup, add the Quick Release Rider Backrest P/N 52300245.

52000207 **\$259.95**
Fits '10-later XL models. Seat width 9.5".



A. SUPER REACH SOLO SEAT

B. REACH SEAT

Designed specifically for riders requiring a close to the bar riding position, without compromising comfort. This seat positions the rider approximately .5" forward, closer to the hand and foot controls. The narrow front profile brings your legs closer together to help you plant your feet firmly on the ground. The slightly bucketed rider seat offers lower back support and features a textured insert to prevent you from sliding around while riding.

51738-07 **\$314.95**
Fits '07-later XL models equipped with 4.5 gallon fuel tank. Models not equipped with passenger pegs require separate purchase of Passenger Footpeg Kit P/N 50203-04 ('04-'13 models) or P/N 50500270 ('14-later models). Seat width 14.0"; passenger pillion width 10.0".

51737-07 **\$314.95**
Fits '07-later XL models equipped with 2.2 or 3.3 gallon fuel tanks. Models not equipped with passenger pegs require separate purchase of Passenger Footpeg Kit P/N 50203-04 ('04-'13 models) or P/N 50500270 ('14-later models). XL883N, XL1200N and XL1200X models also require separate purchase of Retention Washer P/N 7487. Seat width 14.0"; passenger pillion width 10.0".



B. REACH SEAT

C. TALLBOY® SOLO SEAT

Stretch your legs in style. The Tallboy® Solo Seat allows additional leg and arm movement for the long-limbed rider and the long seating space permits fore and aft repositioning while on the open road. The Tallboy Solo Seat moves the rider back 2.5" and up 2.0" compared to the Original Equipment seat on the XL883L model, and 2.0" back and 1.0" up compared to stock seat on XL1200C models. The seat shape and foam density were carefully selected after hundreds of hours of real world testing, and are ideal for riders 5'-9" to 6'-2" tall. The seat features a tapered tail to minimize the profile, and it is crafted with premium vinyl surfaces for durability.

52000209 **\$269.95**
Fits '10-later XL models. Not compatible with Rider Backrest P/N 52300245. Seat width 12.5".



C. TALLBOY SOLO SEAT

Notice: The prices appearing in this catalog are the manufacturer's suggested retail prices. Actual retail prices may vary.



D. SIGNATURE SERIES SOLO SEAT WITH RIDER BACKREST

D. SIGNATURE SERIES® SOLO SEAT WITH RIDER BACKREST

A perfect combination of foam density and shape has created our most comfortable seat for long-haul touring. The wide-seating area will keep the rider extra comfy on a long trip and when you reach your destination, city driving will be easier with the narrow nose that helps keep your legs closer together. Seat features an easily removable adjustable rider backrest that folds down for easier passenger mounting. Rider backrest has a 5-position height adjustment with 1.5" range and a wide range of forward/back angle adjustment with a quick twist of the control knob. Matching Passenger Pillion P/N 52400053 is available for added versatility.

52000034 \$499.95

Fits '07-later XL models with 4.5 gallon fuel tank. Seat width 15.0".

52000062 \$499.95

Fits '07-later XL models with 2.2 or 3.3 gallon fuel tank. Seat width 15.0".

E. SUNDOWNER™ SOLO SEAT

Ride sun-up to sun-down in comfort and style. The Sundowner™ Solo Seat's shape and foam density were developed and refined during hundreds of hours of test rides and ergonomic evaluations. The unique seat features a deep bucket design that cradles the tailbone and provides back support for the rider. The narrow nose of the seat was sculpted to bring the legs closer together, and to look great with any size Sportster® fuel tank. The seat is constructed with premium textured vinyl surfaces for comfort and durability, and features embroidered Bar & Shield logos for style. For two-up riding, simply add the comfortable Sundowner Passenger Pillion P/N 52400121.

52000203 \$259.95

Fits '10-later XL models. Not compatible with Rider Backrest P/N 52300245. Seat width 15.0".

F. SIGNATURE SERIES® PASSENGER PILLION

This carefully styled pillion matches the Sportster® Signature Series® Solo Seat and provides your passenger with a wide seating surface for hours of comfort.

52400053 \$159.95

Fits '07-later XL models equipped with Signature Series Solo Seat P/N 52000034 or 52000062. Pillion width 10.0".

G. SUNDOWNER PASSENGER PILLION

Bring someone along for the ride without giving up your solo status. This carefully styled pillion matches the Sportster Sundowner™ Solo Seat and provides the passenger with great Sundowner comfort. The pillion is shaped to maximize support on a long ride, and is constructed with premium foam and textured vinyl for years on the road.

52400121 \$159.95

Fits '10-later XL models (except XL1200CX) equipped with Sundowner Solo Seat P/N 52000203. Models not equipped with passenger pegs require separate purchase of Passenger Footpeg Kit P/N 50500270 ('14-later models) or 50203-04 ('10-'13 models). Pillion width 11.0".



E. SUNDOWNER SOLO SEAT



F. SIGNATURE SERIES PASSENGER PILLION



G. SUNDOWNER PASSENGER PILLION

Notice: The prices appearing in this catalog are the manufacturer's suggested retail prices. Actual retail prices may vary.

68 SPORTSTER®

Seating — Comfort & Low Profile

A. SUNDOWNER™ SEAT

The Sundowner™ Seat provides the maximum in long-riding comfort. The deep-bucket design puts your body in the proper touring position and the generous padding makes it comfortable for both the rider and passenger as the miles are adding up. The dish-shaped backrest provides added rider back support and the wide passenger pillion is shaped to minimize pressure points.

51739-07 **\$329.95**

Fits '07-'09 XL models equipped with 4.5 gallon fuel tank. Models not equipped with passenger pegs require separate purchase of Passenger Footpeg Kit P/N 50203-04. Seat width 14.5"; passenger pillion width 12.0".

51736-07 **\$329.95**

Fits '07-'09 XL models equipped with 2.2 or 3.3 gallon fuel tanks. Models not equipped with passenger pegs require separate purchase of Passenger Footpeg Kit P/N 50203-04. XL883N, XL1200N and XL1200X models also require separate purchase of Retention Washer P/N 7487. Seat width 14.5"; passenger pillion width 12.0".

51507-04 **\$329.95**

Fits '04-'06 XL models equipped with 4.5 gallon fuel tank. Models not equipped with passenger footpegs require separate purchase of Passenger Footpeg Kit P/N 50203-04 ('04-'13 models). Seat width 15.0"; passenger pillion width 12.5".

51544-01A **\$329.95**

Fits '83-'03 XL models. Seat width 15.0"; passenger pillion width 12.5".

B. BRAWLER® SOLO SEAT

When it's time to go it alone, go in style. These premium quality cowhide leather solo saddles feature a smooth, sleek design that hugs the frame rails for a true custom look. The Brawler® seat's design places the rider "in" the bike for a low-slung riding position, and features a kick-up in the rear to hold the rider in place. The seating position is generally lower than stock, but not as far back as Badlander® or other low profile seats. The top-grain leather seating surface and contoured foam padding provide a firm but luxurious feel. Seat does not fit with passenger pillions.

52000269 **\$299.95**

Fits '10-later XL models. Does not fit with Rider Backrest P/N 52300245. Seat width 12.5".

C. CAFÉ SOLO SEAT

There's something about the placement of the rider that makes the Café Solo Seat special. The one-up design features a high back pad that holds the rider in place and provides a direct connection to the bike. You sit "in" the bike, and your hands and feet reach naturally to the controls. The low-slung black vinyl covered pad, the narrow nose and the tapered tail enhance the bike's sporting profile and pays homage to the heritage of the iconic Café Racer® style.

52000260 **\$349.95**

Fits '10-later XL models. Does not fit with Rider Backrest P/N 52300245. Seat width 9.6".



A. SUNDOWNER SEAT (SHOWN WITH SMOOTH BUCKET LOW BACKREST PAD)



B. BRAWLER SOLO SEAT



C. CAFÉ SOLO SEAT

Notice: The prices appearing in this catalog are the manufacturer's suggested retail prices. Actual retail prices may vary.



D. LEATHER BADLANDER SEAT

D. LEATHER BADLANDER® SEAT

The traditional Badlander® seat's low and lean style sets the stage for your minimalist custom ride. The frame-hugging rider seat and the slim tapered passenger pillion visually stretch the bike and enhance the slammed look. The seat shape stays low along its entire length and follows the lines of the bike with minimal disruption, and delivers a riding position that is lower and generally further back than the stock seat. Ideal for both short riders needing to be closer to the ground, or for tall riders that want to move back in the bike without sitting higher. This seat is wrapped in supple top-grain leather and finished with an embroidered Harley-Davidson script. Kit includes leather grab strap and mounting hardware.

52000259 **\$339.95**

Fits '10-later XL models. XL1200CX requires separate purchase of Low-Profile Sissy Bar Upright P/N 52300403. Models not equipped with passenger pegs require separate purchase of Passenger Footpeg Kit P/N 50203-04 ('10-'13 models) or P/N 50500270 ('14-later models). Seat width 11.5"; passenger pillion width 5.5".

E. BADLANDER CUSTOM SEAT

It's good to be bad. The low and lean Badlander Custom Seat is designed to fit your bike like a glove. The Badlander Seat delivers low-slung cruiser style from the fuel tank to the rear fender, and gives you the feeling of sitting "in" the bike and not on top of it. Ideal for both short riders needing to be closer to the ground, or for tall riders that want to move back in the bike without sitting higher, the seat delivers a riding position that is lower and generally further back than the stock seat. This Badlander Seat features rich textured vinyl seating surfaces for durability, and charcoal black leather side panels and dark gray stitching and Harley-Davidson embroidered script for style. The narrow nose of the seat is sculpted to complement any size Sportster® fuel tank.

52000211 **\$264.95**

Fits '10-later XL models. XL1200CX requires separate purchase of Low-Profile Sissy Bar Upright P/N 52300403. Models not equipped with passenger pegs require separate purchase of Passenger Footpeg Kit P/N 50203-04 ('10-'13 models) or P/N 50500270 ('14-later models). Seat width 11.5"; passenger pillion width 5.5".

F. BADLANDER SEAT

Clean smooth covers, subtle top-stitching and a frame-hugging profile add up to a statement only Harley could create. The low design delivers a reduced seat height that is ideal for riders that want the shortest possible reach to the ground, and the long and lean shape allows tall riders to move back from the hand and foot controls without sitting higher on the bike. Kit includes grab strap and all mounting hardware.

51749-07 **\$264.95**

Fits '07-'09 XL models equipped with 4.5 gallon fuel tank. Models not equipped with passenger pegs require separate purchase of Passenger Footpeg Kit P/N 50203-04. Seat width 12.0"; passenger pillion width 5.0".

51747-07 **\$264.95**

Fits '07-'09 XL models equipped with 2.2 or 3.3 gallon fuel tanks. Models not equipped with passenger pegs require separate purchase of Passenger Footpeg Kit P/N 50203-04. XL883N, XL1200N and XL1200X models also require separate purchase of Retention Washer P/N 7487. Seat width 12.0"; Passenger pillion width 5.0".

52296-94B **\$259.95**

Fits '83-'03 XL models. Seat width 12.0"; passenger pillion width 5.0".



E. BADLANDER CUSTOM SEAT



F. BADLANDER SEAT (51749-07 SHOWN)

NOTE: Some Harley-Davidson® seats are made of leather. Fine leathers or other natural materials WILL gain "character," such as wrinkles or wear, with age. This is normal. A fine, aged patina and character wrinkles are a sign of the extremely high quality materials used to construct your seat or backrest. The appearance of scars or marks on the leather are a result of using natural leather panels and should not be thought of as an imperfection. Please use Harley-Davidson Leather Protectant P/N 93600034 to protect your investment.

Notice: The prices appearing in this catalog are the manufacturer's suggested retail prices. Actual retail prices may vary.

70 SPORTSTER®

Seating — Spring Seats

A. BOBBER SOLO SADDLE

How low can you go? This minimalist solo seat takes the stripped-down garage-built look about as far as you can go. The thick distressed black leather cover is bonded directly to the formed metal seat pan and minimizes the foam filler and the extra height it brings. The raw-edge leather pad is joined to the pan with brass rivets, and features matching brass "Milwaukee Since 1903" trim that will develop a rich patina with use. The Bar & Shield logo is embossed into the leather surface as a finishing touch. Easy to install, the bolt-on seat and a model-specific installation kit includes everything you need to get the bobber look. No cutting, welding or fabrication is necessary.

52000277 Distressed Black Leather. **\$299.95**
Fits '04-'06 and '10-later XL, '06-'17 Dyna® and '08-'17 FLS, FLSS, FLSTC, FLSTN and FXS models. Installation requires separate purchase of model-specific Rigid or Spring Seat Mounting Hardware Kit. Seat width 10.5".

Also available:

RIGID MOUNT SADDLE INSTALLATION KIT

Get the low lean minimalistic garage built look. Required for installation of Solo Saddle Kits P/N 52000277, 52000279, 52000278, 52000275, 52000276, 52000180, 54072-10, 54373-10, 52000114 and 52000113. Kit includes mounting brackets and hardware.

52100016 **\$229.95**
Fits '10-later XL models.

B. SOLO SADDLE

Add nostalgic bobber looks to your modern Harley-Davidson® motorcycle. Available in elegant leather, this solo seat features a low-profile design that provides the minimalistic "just enough to ride" look. The smooth metal seat pan and the simple frame cover leave a clean, finished appearance. Easy to install, the bolt-on seat and model-specific Spring Seat Installation Kit include everything you need to get the bobber look. No cutting, welding or fabrication is necessary and the seat can be removed and replaced with a touring seat for a two-up night on the town.

Fits '04-'06 and '10-later XL, '06-'17 Dyna and '08-'17 FLS, FLSS, FLSTC, FLSTN and FXS models. Installation requires separate purchase of model-specific Rigid or Spring Seat Mounting Hardware Kit. Seat width 10.5".

52000279 Black Leather. **\$299.95**
52000278 Brown Leather. **\$299.95**
52000276 Black Diamond. **\$299.95**

C. SPRING SADDLE INSTALLATION KIT

The torsion-style springs are designed for the optimum balance between spring suspension and support. Required for installation of Solo Saddle Kit P/N 52000277, 52000279, 52000278, 52000275, 52000276, 52000180, 54072-10, 54373-10, 52000114 and 52000113. Kit includes springs, mounting brackets, frame cover and hardware.

54074-10B **\$229.95**
Fits '04-'06 and '10-later XL models.



A. BOBBER SOLO SADDLE (SHOWN WITH RIGID MOUNT SADDLE INSTALLATION KIT)



B. SOLO SADDLE – BLACK LEATHER (SHOWN WITH SPRING SADDLE INSTALLATION KIT)



B. SOLO SADDLE – BROWN LEATHER (SHOWN WITH SPRING SADDLE INSTALLATION KIT)



B. SOLO SADDLE – BLACK DIAMOND (SHOWN WITH SPRING SADDLE INSTALLATION KIT)



C. SPRING SADDLE INSTALLATION KIT

NOTE: Some Harley-Davidson® seats are made of leather. Fine leathers or other natural materials WILL gain "character," such as wrinkles or wear, with age. This is normal. A fine, aged patina and character wrinkles are a sign of the extremely high quality materials used to construct your seat or backrest. The appearance of scars or marks on the leather are a result of using natural leather panels and should not be thought of as an imperfection. Please use Harley-Davidson Leather Protectant P/N 93600034 to protect your investment.

Notice: The prices appearing in this catalog are the manufacturer's suggested retail prices. Actual retail prices may vary.



D. PASSENGER PILLION — (52400130 SHOWN)



D. PASSENGER PILLION — (52400125 SHOWN)



D. PASSENGER PILLION — (52400127 SHOWN)



E. PASSENGER PILLION

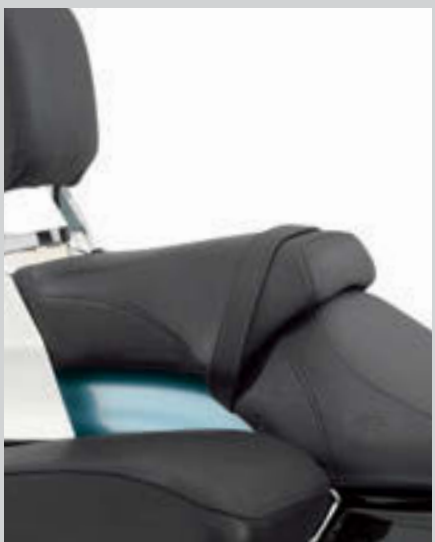

F. PASSENGER PILLION



G. QUICK-RELEASE RIDER BACKREST

D. PASSENGER PILLION

Bring a guest along on your solo-seat equipped Sportster® model. The cover and stitching of this Passenger Pillion complements the solo seat. Kit includes grab strap and mounting hardware.

52400130 '16 XL883L Style. **\$139.95**

Fits '16-later XL883L models with Original Equipment solo seat. Models not equipped with passenger pegs require separate purchase of Passenger Footpeg Kit P/N 50500270. Seat width 9.0".

52400127 '16 XL883N Style. **\$129.95**

Fits '16-later XL883N models with Original Equipment solo seat. Models not equipped with passenger pegs require separate purchase of Passenger Footpeg Kit P/N 50500270. Seat width 7.5".

52400125 '16 XL1200X Style. **\$139.95**

Fits '16-later XL1200X and XL1200XS models with Original Equipment solo seat. Models not equipped with passenger pegs require separate purchase of Passenger Footpeg Kit P/N 50500270. Seat width 7.5".

E. PASSENGER PILLION

Low-profile, minimalistic Passenger Pillion features grey stitching to complement the Original Equipment solo seat on XL1200V and XL1200X models. Easy to install with included hardware and grab strap.

51734-10 **\$139.95**

Fits '10-'15 XL1200V and XL1200X models equipped with Original Equipment solo seat. Requires installation of passenger footpegs (sold separately). Pillion width 7.75".

F. PASSENGER PILLION

Bring a guest along on your solo-seat equipped Sportster model. The smooth cover and top stitching of this Passenger Pillion complements the Original Equipment solo seat and the Reach® Solo Seat. Kit includes grab strap and mounting hardware.

51744-07A **\$134.95**

Fits '07-'15 XL models (except XL1200V and XL1200X) equipped with Original Equipment or Reach Solo Seats. Requires installation of passenger footpegs (sold separately). XL883N and XL1200N models also require separate purchase of Retention Washer P/N 7487. Pillion width 10.0".

G. QUICK-RELEASE RIDER BACKREST

Add exceptional comfort for open road and around town riding. This detachable rider backrest is shaped for maximum lower back support and keeps you in place without shifting you forward in the saddle. Designed to complement Original Equipment and accessory solo seats, the backrest's forward/back position can be adjusted up to 4.5" with a simple fingertip adjustment. The fold-down pad clears the way when throwing your leg over the bike and the backrest can be removed from the bike with the push of a button—leaving behind just two elegant docking points. Complete kit includes upright, pad, fender strut brackets and all required hardware.

52300245 **\$249.95**

Fits '04-later XL models equipped with a solo seat. Not compatible with Brawler® Solo Seat P/N 52000269, 52941-04B, 52000118, 52000119, Cafe Solo Seat P/N 52000260, Sundowner™ Solo Seat P/N 52000203, Tallboy® Solo Seat P/N 52000209, Solo Rigid or Spring Seat Mounting Kits, '16-later Original Equipment XL883N Solo Seat, or Side-Mount License Plate Kits P/N 60947-10 or 60972-10. Installation of H-D® Detachables™ Solo Luggage Rack requires additional purchase of Bolt P/N 3584 (Qty. 4).

72 SPORTSTER®

Seating

A. ROAD ZEPPELIN® SEAT PAD

Experience ultimate comfort. Designed to ensure hours of comfort in the saddle, Road Zeppelin® Seat Pads are equipped with a unique air bladder system that allows your weight to be supported evenly across the entire seating surface. Whether you have a low profile seat or a larger more comfortable seat, you will feel the benefits. This air bladder system is designed to reduce pressure points, provide shock absorption, and reduce vibration. Unlike other mouth-inflated seat pads, the Road Zeppelin Pad features an easy-to-reach integrated hand pump and metered air release valve that permits quick and controllable adjustment. You can easily adjust the comfort and support while seated on the pad. The UV-stable and snag resistant mesh cover allows air to circulate beneath the rider's body, reducing the temperature trapped between the rider and seat. Shaped to conform to most Harley-Davidson® seats, the pads feature adjustable mounting straps and a non-skid surface to keep them in place. The hand-washable seat pad can be deflated and rolled for compact storage.

52000327 Rider. **\$169.95**

Fits rider position on all models equipped with Original Equipment or accessory seats. Also fits passenger position on Touring models with large pillion area. Pad width – 14.0".

52400162 Passenger. **\$149.95**

Fits Original Equipment and accessory passenger pillions. Pad length – 12.0"; width – 9.0".



A. ROAD ZEPPELIN SEAT PAD

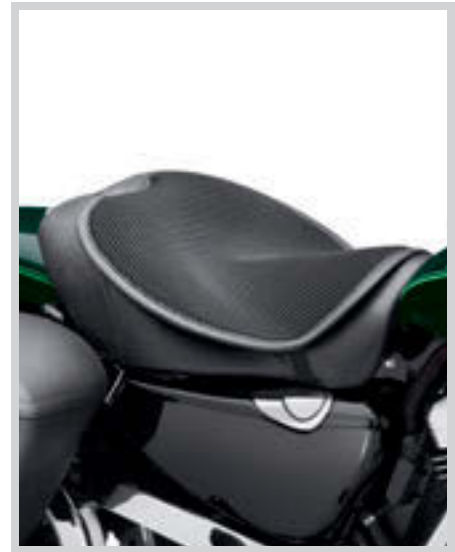

B. CIRCULATOR SEAT PAD – (RIDER SHOWN)

B. CIRCULATOR SEAT PADS

These breathable Circulator Seat Pads feature 3D construction that promotes air movement and reduces heat build-up where the rider's body touches the seat or backrest. Designed to keep the rider cool by reducing the perspiration build-up between you and the seating surface, the Circulator Pad can be installed and removed in seconds for easy cleaning. The low-profile design minimizes seat-height change compared to inflatable pads, while enhancing comfort with its shock-absorbing construction. Manufactured of UV-stable materials. Elastic under-seat strap and non-slip base provide secure installation and the available Circulator Passenger Pillion Pad attaches to the rider pad with hook-and-loop tabs.

51074-10 Medium Seat Pad. **\$84.95**

Fits VRSC™, XG, XL and Dyna® models with Original Equipment and accessory seats. Pad width – 14.5".

51078-10 Passenger Pillion Pad. **\$69.95**

Fits Original Equipment and accessory passenger pillions. Pad width – 13.0".



C. REAR FENDER BIB

C. REAR FENDER BIB

Go solo in style. Wrapped in smooth vinyl to match Original Equipment or accessory solo seats, the Fender Bib features an embossed Bar & Shield logo for added style. The molded base is finished with a soft felt under-liner designed to protect the fender's painted surface.

52017-08 **\$59.95**

Fits '04-later XL models (except XL883N, XL1200CX, XL1200NS, XL1200T, XL1200V, XL1200X, and XL1200XS) equipped with Original Equipment solo seat or Reach® Solo Seat P/N 51750-07 or 51751-07. Will not fit models equipped with Bobtail Rear Fender.

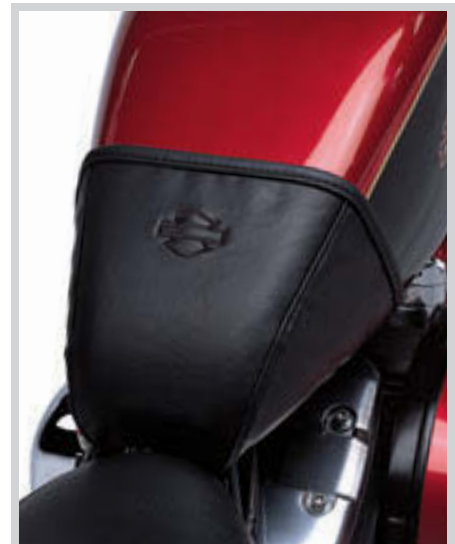

D. TANK BRA

D. TANK BRA

This Tank Bra is made with non-abrasive, fleece-backed vinyl material and features an embroidered Bar & Shield logo. It protects your fuel tank from scratches from keys, belt buckle, etc.

62027-04 **\$42.95**

Fits '04-later XL models equipped with 4.5 gallon fuel tank.

62030-04 **\$42.95**

Fits '04-later XL models equipped with 3.3 gallon fuel tank.

61929-98 **\$42.95**

Fits '97-'03 XL models equipped with 3.3 gallon fuel tanks.



E. QUICK-RELEASE SEAT HARDWARE KIT – CHROME

E. QUICK-RELEASE SEAT HARDWARE KIT

This Quick-Release Hardware Kit allows the rider to remove one-piece Harley-Davidson seats quickly and easily. A raised-logo Harley-Davidson emblem finishes the look. SAE 1/4"-20 thread.

Fits '97-later XG, XL, Dyna, Softail® (except '12-'17 FLS models equipped with Original Equipment seat), Touring and Trike models equipped with SAE 1/4"-20 seat mount hardware. Does not fit seats equipped with spring-loaded rear seat bracket.

51676-97A Chrome. **\$19.95**

10500093 Gloss Black. **\$19.95**

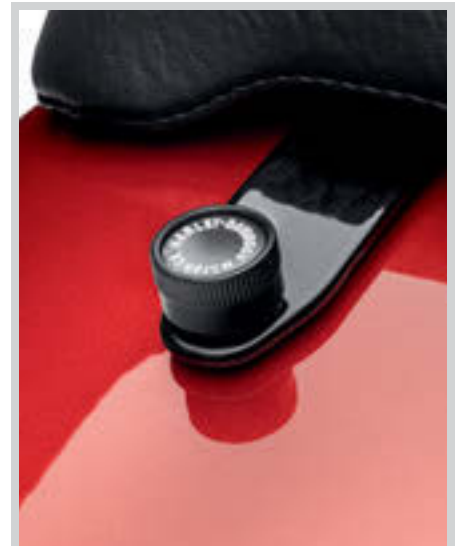

E. QUICK RELEASE SEAT HARDWARE KIT – GLOSS BLACK

Notice: The prices appearing in this catalog are the manufacturer's suggested retail prices. Actual retail prices may vary.

BUILDING A BACKREST

A sissy bar upright and passenger backrest are the starting point to build a complete touring machine. The backrest provides long-range comfort and support and adds a feeling of control and confidence for the passenger. Start by selecting model-specific Docking Hardware, then choose a finish that matches your styling direction, determine the desired sissy bar height, and finally select a backrest pad that complements your seat.

DOCKING HARDWARE

PAGE 73



SHORT UPRIGHT

PAGE 74



TALL UPRIGHT

PAGE 74



SIDE PLATES

PAGE 74



PASSENGER BACKREST PAD

PAGE 76



SELECT THE DOCKING HARDWARE

Sportster® Docking Hardware for H-D® Detachables™ Racks and Sideplates
Docking hardware fitment is dependent on vehicle model and saddlebag configuration.

<i>H-D Detachables Accessory</i>	<i>Available to fit:</i>	Required Docking Hardware	
Detachable Sideplates, Detachable Solo Rack 53494-04A, 53512-07A One-Piece Detach Sissy Bar Upright 51146-10A, 52300040A or Detachable Solo Tour-Pak® Rack 53655-04A with Leather Saddlebags 90330-08.	2004-later XL models (except XL1200CX)	53544-04	\$44.95
Detachable Sideplates, Detachable Solo Rack 53494-04A, 53512-07A One-Piece Detach Sissy Bar Upright 51146-10A, 52300040A or Detachable Solo Tour-Pak® Rack 53655-04A with Leather Saddlebags 90201321, 90201325 and 88312-07A.	2004-later XL models (except XL1200CX)	53544-04	\$44.95
Detachable Sideplates, Detachable Solo Rack 53494-04A, 53512-07A One-Piece Detach Sissy Bar Upright 51146-10A without Leather Saddlebags.	2004-later XL models (except XL1200CX)	53529-04	\$44.95
Detachable Sideplates or Detachable Solo Rack 53494-04A, 53512-07A One-Piece Detach Sissy Bar Upright 51146-10A or Solo Tour-Pak Mounting Rack 53655-04A with Hard Saddlebags 91412-0XXX. Hard Saddlebags also require purchase of Hardware Kit 91405-04.	2004-later XL models (except XL1200CX)	53529-04	\$44.95
Detachable Sideplates 53545-95A, 53609-01 or Detachable Solo Rack 53495-95 with Leather Saddlebags 90598-04, 90342-04A, 90201329 or 90330-08.	1994-2001 XL models	90465-98A	\$69.95
	2002-2003 XL (except XL883R and XL1200S)	53532-02	\$69.95
Detachable Sideplates 53545-95A, 53609-01 or Detachable Solo Rack 53495-95 without Leather Saddlebags.	1994-2003 XL models (except XL883R and XL1200S)	53528-95B	\$44.95

Notice: The prices appearing in this catalog are the manufacturer's suggested retail prices. Actual pricing may vary.

74 SPORTSTER®

Backrests & Racks

A. H-D® DETACHABLES™ SIDEPLATES

In the time it takes for a traffic light to change, you can transform your motorcycle from a city cruiser to a cross country hauler. Start with Harley-Davidson® Detachables™ Sideplates, and add your choice of sissy bar upright and pad to make removing the passenger backrest a simple slide and click operation. Manufactured and tested to rigorous Harley-Davidson standards, installation requires separate purchase of model-specific Docking Hardware Kit.

Fits '04-later XL models (except '16-later XL1200CX). All models require separate purchase of Docking Hardware Kit (see docking hardware matrix). Docking hardware is Original Equipment on XL1200T models.

1. 53913-04	Chrome.	\$149.95
2. 52710-07	Gloss Black.	\$149.95

B. LOW SISSY BAR UPRIGHT

Shaped to complement a thicker passenger pillion, this Low Sissy Bar Upright stands between the Standard and Short Sissy Bar Upright. The ideal match for touring style seats, this upright also offers an additional height option to riders with custom style seats.

Fits '04-later XL models with H-D Detachables sideplates, '06-'17 Dyna® (except FXDF, FXDFSE and '10-'17 FXDWG), '84-'05 Softail® (except FXSTD) and '06-later FL Softail models (except '07-'17 FLS, FLSS, FLSTF, FLSTFB, FLSTFBS, FLSTSE and FLSTSB and '06 FLSTFSE) with appropriate sideplates.

52300022	Chrome.	\$99.95
52300024	Gloss Black.	\$99.95

C. STANDARD SISSY BAR UPRIGHT

Give your passenger additional back support with a Standard Sissy Bar Upright, designed to accept a wide variety of Backrest Pads.

Fits '04-later XL models with H-D Detachables sideplates, '06-'17 Dyna (except FXDF, FXDFSE and '10-'17 FXDWG), '84-'05 Softail (except FXSTD) and '06-later FL Softail models (except '07-'17 FLS, FLSS, FLSTF, FLSTFB, FLSTFBS, FLSTSE and FLSTSB and '06 FLSTFSE) with appropriate sideplates.

52300018	Chrome.	\$99.95
52300020	Gloss Black.	\$99.95



A. H-D DETACHABLES SIDEPLATES



B. LOW SISSY BAR UPRIGHT – CHROME



B. LOW SISSY BAR UPRIGHT – GLOSS BLACK



C. STANDARD SISSY BAR UPRIGHT – CHROME



C. STANDARD SISSY BAR UPRIGHT – GLOSS BLACK

Notice: The prices appearing in this catalog are the manufacturer's suggested retail prices. Actual retail prices may vary.



D. ONE-PIECE H-D DETACHABLES SISSY BAR UPRIGHT – GLOSS BLACK (SHOWN WITH SMOOTH BACKREST PAD)



D. ONE-PIECE H-D DETACHABLES SISSY BAR UPRIGHT – CHROME (SHOWN WITH SMOOTH BACKREST PAD)



E. PASSENGER BACKREST PAD – XL883N STYLE



E. PASSENGER BACKREST PAD – XL1200X STYLE



F. LOW-PROFILE SISSY BAR UPRIGHT



G. SLIP-OVER PASSENGER BACKREST PAD

D. ONE-PIECE H-D® DETACHABLES™ SISSY BAR UPRIGHT

The sweeping shape of this slim, round bar Sissy Bar Upright completes the classic bobber look. The one-piece design eliminates separate sideplates for a clean appearance and the stylized upper kick angle mimics the old-school sissy bars of the '50s and '60s. Available in your choice of chrome or gloss black finish, these bars can be equipped with Passenger Backrest Pad P/N 52631-07.

Fits '04-later XL models (except '16-later XL1200CX). All models require separate purchase of Docking Hardware Kit (see docking hardware matrix). Docking hardware is Original Equipment on XL1200T models.

51146-10A	Gloss Black.	\$209.95
52300040A	Chrome.	\$209.95

E. PASSENGER BACKREST PADS

Styled to complement available touring and custom seats.

Fits models equipped with One Piece H-D® Detachables™ Sissy Bar Upright P/N 52729-08, 51853-07, 51849-07, 51146-10A, 51161-10A, 52300040A, 52300042A, 52300044A or 52300046A.

52631-07	Smooth Black.	\$74.95
52300366	XL883N Style.	\$79.95
52300364	XL1200X Style.	\$79.95

F. LOW-PROFILE SISSY BAR UPRIGHT

This low and lean one-piece bar mounts between the fender and fender struts for a clean, close to the bike profile. The gloss black round bar upright delivers a simple bobber look on a solo seat equipped bike, and provides the perfect passenger "butt-stop" for a Sportster® model equipped with a low-profile two-up seat. The bar also accepts Slip-Over Pad P/N 51732-10 for added passenger comfort.

52300403		\$149.95
-----------------	--	-----------------

Fits 16-later XL1200CX models with Original Equipment two-up seat and '07-later XL models equipped with solo or Badlander® two-up seats.

G. SLIP-OVER PASSENGER BACKREST PAD

This Slip-Over Backrest Pad provides a touch of passenger comfort, while maintaining the long, lean style of the Dyna® Wide Glide® model. Held in place with hook-and-loop tabs, this rich black pad features grey stitching that complements the Original Equipment seat and pillion.

51732-10		\$69.95
-----------------	--	----------------

Fits '07-later XL models with Low-Profile Sissy Bar Upright P/N 52300403 and '10-'17 FXDWG models with Original Equipment sissy bar upright.

76 SPORTSTER®

Backrests & Racks

PASSENGER BACKREST PADS

Choose from a wide variety of backrest pad sizes and shapes to match your comfort and style demands. Designed to complement Original Equipment and accessory seats, these pads are engineered to fit specific sissy bar upright types.

A. BACKREST PADS

Sized to fit medallion and mini medallion-style sissy bar uprights. Pad mounts with single center screw and bolt-on mounting strap. Includes chrome-plated mounting hardware.

Fits Low Medallion Style Sissy Bar Upright P/N 52754-04 or 51851-09, Low Square Bar Mini-Medallion Style Sissy Bar Upright P/N 53282-06, Standard Square Bar Mini Medallion Style Sissy Bar Upright P/N 53281-06 or 53407-06, Standard Medallion Style Sissy Bar Upright P/N 52735-85, 53007-98, 52655-84, 52909-02 or 51517-02, Standard Bar & Shield Style Sissy Bar Upright 52739-83 or 51514-02, Standard Heritage Style Sissy Bar Upright P/N 52731-00 and Low Round Bar Sissy Bar Upright P/N 52300022 or 52300024.

1. 52652-04	Smooth.	\$74.95
2. 52626-04	Smooth Top-Stitched.	\$74.95



A. BACKREST PADS

B. BACKREST PADS

Sized to fit medallion and mini medallion-style sissy bar uprights. Pad mounts with single center screw and bolt-on mounting strap. Kit includes chrome-plated mounting hardware.

Fits Low Medallion Style Sissy Bar Upright P/N 52655-84, 52909-02, 52754-04, 51851-09, Standard Medallion Style Sissy Bar Upright P/N 52735-85 or 52877-08, Standard Square Bar Mini Medallion Style Sissy Bar Upright P/N 53281-06 or 53407-06, Standard Heritage Style Sissy Bar Upright P/N 52731-00 and Standard Round Bar Sissy Bar Upright P/N 52300018 or 52300020.

1. 52612-95	Smooth Top-Stitched.	\$74.95
2. 52412-79A	Embossed Bar & Shield Logo.	\$79.95
3. 52348-97	Heritage Classic Bucket.	\$109.95
4. 52347-97	Fat Boy® Bucket.	\$109.95
5. 51132-98	Smooth Bucket.	\$99.95



B. BACKREST PADS

Notice: The prices appearing in this catalog are the manufacturer's suggested retail prices. Actual retail prices may vary.



C. REAR DOCKING HARDWARE COVER KIT – BLACK



C. REAR DOCKING HARDWARE COVER KIT – CHROME

C. REAR DOCKING HARDWARE COVER KIT

Disguise the rear docking hardware with these easy-to-install covers. The caps slide over the exposed docking points and are held in place by a strong magnetic pull. The caps are easy to remove when you wish to reinstall detachable accessories. Covers are available with brilliant chrome or durable gloss black finish to match your bike's attitude. Sold in pairs.

Fits many accessory docking hardware kits. Refer to the fitment matrix in this P&A Catalog page 571 or the Parts & Accessories section of www.harley-davidson.com for details.

48218-10	Short Chrome (pair).	\$34.95
48220-10	Large Chrome (pair).	\$34.95
48035-09	Small Chrome (pair).	\$34.95
48221-10	Short Black (pair).	\$34.95
48223-10	Large Black (pair).	\$34.95
48225-10	Small Black (pair).	\$34.95

D. LOCKING H-D® DETACHABLES™ LATCH KIT

This unique lock replaces the camlock on your Harley-Davidson® Detachables™ accessories, providing additional security and peace of mind when parking your vehicle. The kit includes two extended-reach barrel-style keys for easy access to the lock. Key registration and replacement service is available. Sold in pairs.

Fits all models equipped with detachable Sideplates, Racks and Tour-Pak® Luggage Carriers (except '18-later Softail® models with HoldFast™ racks and uprights or '09-later Touring models equipped with detachable Solo Tour-Pak Rack).

90300087	Chrome.	\$79.95
90300086	Black.	\$74.95

E. H-D DETACHABLES LATCH KIT – CHROME

Decorative chrome latches are the perfect way to enhance the appearance of your detachable accessories. Meticulously polished and chrome-plated, these easy-to-install Rotary Latches are a direct replacement for the Original Equipment satin black parts and are a simple way to add a finishing touch to your ride. Latches feature an easy-to-pull finger release to simplify access in hard-to-reach areas.

12600036 **\$49.95**

Fits all models equipped with detachable Sideplates, One-Piece Sissy Bar Uprights, Racks, and Tour-Pak Luggage Mounting Racks (except '18-later Softail models with HoldFast racks and uprights).



D. LOCKING H-D DETACHABLES LATCH KIT – CHROME



D. LOCKING H-D DETACHABLES LATCH KIT – BLACK



E. H-D DETACHABLES LATCH KIT – CHROME

Notice: The prices appearing in this catalog are the manufacturer's suggested retail prices. Actual retail prices may vary.

78 SPORTSTER®

Backrests & Racks

A. AIR FOIL PREMIUM LUGGAGE RACK*

The low-profile aerodynamic styling defines the look of this Luggage Rack. Available in mirror chrome or rich gloss black finish, the die-cast rear "Air Foil" grabs your attention and the Bar & Shield™ insert adds a signature touch. The elegant round tube rack features inlaid rubber runners for added grip and dedicated bungee mounting points to simplify luggage tie-down. Kit includes all necessary mounting hardware. For added visibility, the rack is designed to incorporate the internal wiring of the Air Foil Rack LED Light Kit P/N 68000076 (red) or 68000077 (smoked) for a clean look.

Fits '04-later XL models (except XL1200CX) equipped with H-D® Detachables™ Sideplates, '06-'17 Dyna® models (except FXDF, FXDFSE and '10-'17 FXDWG) equipped with Detachable Sideplates, '84-'05 Softail® models (except FLSTN and FXSTD) and '06-'17 FLST, FLSTC, FLSTNSE and FLSTSC models and '06 FLSTF models equipped with Detachable Sideplates.

54290-11	Chrome.	\$214.95
54291-11	Gloss Black.	\$214.95

B. LED LIGHT KIT**

This fast-acting LED Light Kit operates as a supplemental rear running light and brake light. The high, center-mount position places the light in the line-of-sight of following vehicles and the bright, fast-acting LED lamps get you noticed. Wiring is concealed inside the rack tubes for a clean, custom installation. Available with red or smoked lens.

Fits Air Foil Luggage Rack P/N 54290-11, 54291-11 and Air Wing Sissy Bar Upright P/N 52300146 and 52300147. Installation requires separate purchase of model-specific Wiring Harness Kit.

68000076	Red Lens.	\$49.95
68000077	Smoked Lens.	\$49.95

Also available:

LED LIGHT KIT WIRING HARNESS

Required for installation of LED Light Kit on Air Foil Luggage Rack P/N 54290-11 or 54291-11.

70683-08		\$9.95
Fits '14-later XL models with Air Foil Luggage LED Light Kit P/N 68000076 or 68000077.		
69368-11		\$11.95
Fits '04-'13 XL models with Air Foil Luggage LED Light Kit P/N 68000076 or 68000077.		

C. FIVE BAR SPORT LUGGAGE RACK – CHROME*

This rack brings touring flexibility to your motorcycle. Can be used with H-D® Detachable™ or Rigid Mount Sissy Bar Sideplates.

53862-00		\$149.95
Fits '04-later XL models (except XL1200CX) equipped with Detachable Sideplates, '06-'17 Dyna models (except FXDF, FXDFSE and '10-'17 FXDWG) equipped with Detachable Sideplates, '84-'05 Softail models (except FLSTN and FXSTD), '06-'17 FLST, FLSTC and FLSTSC models and '06 FLSTF models equipped with Detachable Sideplates. Does not fit with Round Bar Uprights P/N 52300018, 52300020, 52300022 and 52300024.		



A. AIR FOIL PREMIUM LUGGAGE RACK – CHROME



A. AIR FOIL PREMIUM LUGGAGE RACK – GLOSS BLACK



B. LED LIGHT KIT – RED LENS SHOWN



C. FIVE BAR SPORT LUGGAGE RACK – CHROME



***WARNING:** Do not use this rack as a seat. Do not exceed the fender rack weight capacity. Using as seat or exceeding this capacity could cause handling problems which could result in loss of control and death or serious injury.



****WARNING:** Disconnecting your DOT required tail, brake and turn signal lighting could reduce your visibility to others and result in death or serious injury.

Notice: The prices appearing in this catalog are the manufacturer's suggested retail prices. Actual retail prices may vary.



D. CUSTOM TAPERED SPORT LUGGAGE RACK – CHROME



D. CUSTOM TAPERED SPORT LUGGAGE RACK – GLOSS BLACK

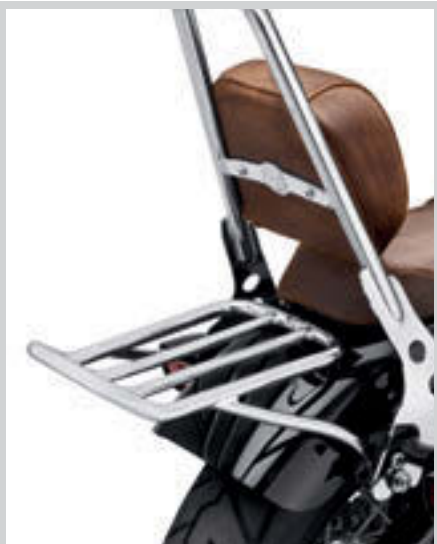

E. CHOPPED FENDER LUGGAGE RACK – CHROME



E. CHOPPED FENDER LUGGAGE RACK – GLOSS BLACK



F. H-D DETACHABLES SOLO RACK – CHROME



F. H-D DETACHABLES SOLO RACK – GLOSS BLACK

D. CUSTOM TAPERED SPORT LUGGAGE RACK*

Smooth sweeping curves and the brilliant chrome or gloss black finish define the look of this Sport Luggage Rack. Designed to complement both round and square bar Sissy Bar Uprights, this sleek rack adds a practical and stylish touch to the motorcycle.

Fits '04-later XL models (except XL1200CX) equipped with H-D® Detachables™ Sideplates, '06-'17 Dyna® models (except FXDF, FXDFSE and '10-'17 FXDWG) equipped with Detachable Sideplates, '84-'05 Softail® models (except FLSTN and FXSTD) and '06-'17 FLST, FLSTC, FLSTNSE and FLSTSC models and '06 FLSTF models equipped with Detachable Sideplates.

50300030	Chrome.	\$149.95
50300031	Gloss Black.	\$149.95

E. CHOPPED FENDER LUGGAGE RACK*

This Luggage Rack is the ideal option for your ride across town or across the state. Designed for the chopped rear fender, this simple rack adds practical luggage space without compromising style. Rear supports attach to the fender struts and the rack is secured to the passenger pillion mounting point on the rear fender. Available in your choice of chrome or gloss black finish, this rack is compatible with H-D® Detachables™ Uprights and docking hardware.

Fits '09-later XL883N and '07-later XL1200N, XL1200V, XL1200X and '18-later XL1200NS and XL1200XS models. Use with H-D Detachables Docking Hardware and Uprights requires separate purchase of Docking Kit P/N 53686-96A.

50300040	Chrome.	\$149.95
54250-10	Gloss Black.	\$149.95

F. H-D® DETACHABLES™ SOLO RACK*

Add touring capabilities to your solo seat Sportster® model in less than 60 seconds. This detachable Solo Rack fits over the fender when the passenger pillion is removed. The rack features brazed hand-polished tubing and the chrome-plated or gloss black finish adds a stylish flair. Requires Docking Hardware.

Fits '04-later XL models (except XL1200CX) equipped with solo seat. All models require separate purchase of appropriate Docking Hardware. Docking Hardware is Original Equipment on XL1200T models.

53494-04A	Chrome.	\$189.95
53512-07A	Gloss Black.	\$189.95



***WARNING:** Do not use this rack as a seat. Do not exceed the fender rack weight capacity. Using as seat or exceeding this capacity could cause handling problems which could result in loss of control and death or serious injury.

Notice: The prices appearing in this catalog are the manufacturer's suggested retail prices. Actual retail prices may vary.



STEP ONE:
**FIND
YOUR FIT**

	H-D® Detachables™ Locking Saddlebags – Synthetic and Genuine Leather 90201328 \$879.95	Distressed Black Leather Saddlebags 90201306 \$659.95	Sportster® Leather Saddlebags 90201329 \$684.95
'04-later XL models	Fits (model exceptions below)	Fits (model exceptions below)	
'94-'03 XL models	—	Fits (model exceptions below)	
'82-later XL	—	—	
Does not fit models:	XL1200CX, XL1200T, XL1200V	XL1200CX, '02-'03 XL883R XL1200S, XL1200T	
Does not fit if models have:	Rear Axle Covers	Rear Axle Covers, Flat Lens Turn Signal, Detachable Side Plates, Accessory Bullet Style Turn Signals: P/N 68005-99 and 68637-99	

STEP TWO:
**PICK
YOUR BAG**

	H-D Detachables Locking Saddlebags – Synthetic and Genuine Leather	Distressed Black Leather Saddlebags	Sportster Leather Saddlebags
Luggage Capacity	2,400CI	3,000CI	3,000CI
Dimensions L x W x H	16" x 6" x 12"	20" x 6" x 13"	20" x 6" x 12"
Mounting Style	Detachable	Rigid	Rigid/Detachable
Lockable Lid	Yes	No	No

STEP THREE:
**INSTALLATION
REQUIREMENTS**

Turn Signal Relocation Kit		Turn Signal Relocation Kit	
'11-later XL1200C models	P/N 67800071 (Domestic) P/N 67800077 (International)	'94-'03 models	P/N 68485-04
International (non-Canadian) models: XL883N, XL1200N or XL1200X	P/N 67800075	'04-later models with center mounted license plates	P/N 68474-04B (Chrome) P/N 73281-10 (Black)
All other models	P/N 68732-02A (Domestic) 68733-02A (International) or Layback License Plate Kit P/N 60215-06	'11-later XL1200C models	P/N 67800071 (Domestic) P/N 67800077 (International)
		International (non-Canadian) XL883N, XL1200N, XL1200V and XL1200X models	P/N 67800075
Docking Hardware Kit		Docking Hardware Kit	
Required separate purchase	P/N 90201424	'94-'03 models equipped with H-D® Detachables™ accessories	P/N 90465-98A or P/N 53532-02
Models equipped with H-D Detachables accessories (if not already equipped)	P/N 53529-04 and P/N 88390-10		
Models equipped with Rigid Sideplates Models equipped with Saddlebags only	P/N 53529-04		
License Plate/Turn Signal Relocation Kit		License Plate/Turn Signal Relocation Kit	
Models with Side-Mount License Plates	P/N 73279-10	Models with Side-Mount License Plates	P/N 73279-10
Passenger Footpeg Kit			
Models not equipped with Passenger Pegs	P/N 50203-04 ('04-'13 models) or P/N 50500270 ('14-later models)		

Notice: The prices appearing in this catalog are the manufacturer's suggested retail prices. Actual retail prices may vary.



Rigid Leather Locking Saddlebags 90201321 \$729.95	Express Rider Large Capacity Leather Saddlebags 90201325 \$599.95	Synthetic Leather Saddlebags 90330-08 \$429.95	Throw-Over Saddlebags		
			Black Standard Large 90201770 \$269.95	Black Standard Compact 90201769 \$219.95	Leather 91008-82C \$369.95
Fits (model exceptions below)		Fits (model exception below)		Fits (model exception below)	
—		—		Fits (model exception below)	
—		—		Fits (model exception below)	
XL1200CX, XL1200T, XL1200V and international (non-canadian) XL883N, XL1200N, XL1200X		XL1200T, XL883N, XL1200CX, XL1200N, XL1200V, XL1200X		XL1200T	
Rear Axle Covers		Side-Mount License Plates Rear Axle Covers Flat Lens Turn Signals 2-into-1 exhaust		—	

Rigid Leather Locking Saddlebags	Express Rider Large Capacity Leather Saddlebags	Synthetic Leather Saddlebags	Large	Compact	Leather
2,800Cl	3,000Cl	2,000Cl	1,350Cl	600Cl	1,700Cl
22" x 5" x 13"	18" x 9" x 11"	22" x 7" x 13"	16.5" x 7" x 11.5"	10" x 5.25" x 11.5"	13" x 6" x 11"
Rigid	Rigid	Rigid	Throw-Over	Throw-Over	Throw-Over
Yes	No	No	No	No	No

Turn Signal Relocation Kit		Turn Signal Relocation Kit		Saddlebag Supports	
'11-later XL1200C models	Kit P/N 67800071 (Domestic) 67800077 (International)	'04-later models	P/N 68732-02A (Domestic) P/N 68733-02A (International) or Layback License Plate Kit P/N 60215-06	'00-later XL (except XL1200CX/S/T and '02-'03 XL883R) Does not fit with H-D Detachables accessories	P/N 90201324 (Chrome)
All other models	P/N 68732-02A (Domestic) 68733-02A (International) or Layback License Plate Kit P/N 60215-06	'11-later XL1200C	P/N 67800071 (Domestic) 67800077 (International)	'94-'15 XL models (except XL1200S/T and '02-'03 XL883R) Does not fit with H-D Detachables accessories	P/N 90799-94D (Chrome) (includes Chrome Upper Shock Covers P/N 54711-94)
				'00-later XL models (except XL1200S/T and '02-'03 XL883R) Does not fit with H-D Detachables accessories	P/N 90201433 (Gloss Black)

Docking Hardware Kit	
Models equipped with H-D Detachables Accessories (if not already equipped)	P/N 53544-04

License Plate/Turn Signal Relocation Kit	
Models with Side-Mount License Plates	P/N 73279-10

SPORTSTER

82 SPORTSTER®

Saddlebags & Luggage

A. H-D® DETACHABLES™ LOCKING SADDLEBAGS – SYNTHETIC AND GENUINE LEATHER

These large-capacity lockable detachable saddlebags are completely removable with the simple pull of the internal handle, leaving your bike clean and ready to cruise the boulevard. Made with Genuine leather lids and straps and a synthetic leather body, these slant-style bags feature hidden quick-release clips behind the classic valise straps and black buckles. When removed, the large capacity bags leave behind two simple, inconspicuous docking points. The bags are compatible with both rigid and H-D® Detachables™ accessories when installed with the appropriate docking hardware kits. Luggage capacity: 2400 cubic inches total.

90201328 **\$879.95**

Fits '04-later XL models (except XL1200CX, XL1200T and XL1200V). Requires separate purchase of Docking Hardware Kit 90201424. Models not equipped with Passenger Pegs require separate purchase of Passenger Footpeg Kit P/N 50203-04 ('04-'13 models) or P/N 50500270 ('14-later models). Domestic XL883N, XL1200N and XL1200X models require License Plate/Directional Relocation Kit P/N 73279-10. International (non-Canadian) XL883N, XL1200N or XL1200X models require Directional Relocation Kit P/N 67800075. '11-later XL1200C models require Directional Relocation Kit P/N 67800071 (Domestic) or 67800077 (International). All other models require separate purchase of Turn Signal Relocation Kit P/N 68732-02A (Domestic), 68733-02A (International) or Layback License Plate Kit P/N 60215-06. Models equipped with Saddlebags only or with Rigid Sideplates require separate purchase of Docking Hardware Kit P/N 53529-04. Models equipped with detachable accessories require separate purchase of Docking Hardware Kit P/N 53529-04 (if not already equipped) and 88390-10. Does not fit with Rear Axle Covers or Bobtail Fender.

Also available:

DOCKING HARDWARE KIT

Required for installation of H-D Detachable Saddlebag P/N 90201328. Includes all hardware needed for Saddlebag only or Saddlebag with additional detachable accessories.

90201424 **\$84.95**

Fits '04-later XL models (except XL1200T and XL1200V).

Also available:

DOCKING HARDWARE KIT

Required when installing H-D Detachables accessories with H-D Detachables Saddlebag P/N 88358-10.

88390-10 **\$49.95**

Fits '04-later XL models (except XL1200T and XL1200V).

Also available:

LICENSE PLATE/DIRECTIONAL RELOCATION KIT

Required when installing certain XL Saddlebags on models originally equipped with side-mount license plate.

73279-10 **\$219.95**

Fits '07-later XL883N, XL1200N, XL1200NS, XL1200V, XL1200X, and XL1200XS models with side-mounted license plate and equipped with XL Saddlebag Kit P/N 53050-10, 88358-10 or 90342-04A.

Also available:

DIRECTIONAL RELOCATION KIT

Kit moves turn signals from rear fender struts to a license bracket-mounted turn signal bar. Required for installation of fixed mount or detachable saddlebags on XL1200C models.

67800071 Domestic. **\$99.95**

Fits '11-later XL1200C Domestic models.

NOTE: Some Harley-Davidson® saddlebags are made of leather. Fine leathers or other natural materials WILL gain "character," such as wrinkles or wear, with age. This is normal. A fine, aged patina and character wrinkles are a sign of the extremely high quality materials used to construct your saddlebags. The appearance of scars or marks on the leather are a result of using natural leather panels and should not be thought of as an imperfection. Please use Harley-Davidson Leather Protectant P/N 93600034 to protect your investment.

Notice: The prices appearing in this catalog are the manufacturer's suggested retail prices. Actual retail prices may vary.



A. H-D DETACHABLES LOCKING SADDLEBAGS
SYNTHETIC AND GENUINE LEATHER – INSTALLED



A. H-D DETACHABLES LOCKING SADDLEBAGS
SYNTHETIC AND GENUINE LEATHER – REMOVED

**B. DISTRESSED BLACK LEATHER SADDLEBAGS****C. SPORTSTER LEATHER SADDLEBAGS****D. RIGID LEATHER LOCKING SADDLEBAGS****SPORTSTER® LEATHER SADDLEBAGS**

Fits '94-later XL models. Does not fit XL1200CX, XL1200S, XL1200T, '02-'03 XL883R or models equipped with Rear Axle Covers, Flat Lens Turn Signals, accessory Bullet Style Turn Signals P/N 68005-99 and 68637-99, or '04-later models with detachable sideplates. '94-'03 models require separate purchase of Turn Signal Relocation Kit P/N 68485-04. '94-'03 models equipped with H-D® Detachables™ accessories require separate purchase of Docking Hardware Kit P/N 90465-98A or 53532-02. '04-later models with center mounted license plates require separate purchase of Turn Signal Relocation Kit P/N 68474-04B (chrome) or 73281-10 (black). Models with side-mount license plates require separate purchase of License Plate/Turn Signal Relocation Kit P/N 73279-10. '11-later XL1200C models require purchase of Turn Signal Relocation Kit P/N 67800071 (Domestic) or 67800077 (International). International (non-Canadian) XL883N, XL1200N, XL1200V and XL1200X models require separate purchase of Directional Relocation Kit P/N 67800075.

B. DISTRESSED BLACK LEATHER SADDLEBAGS

Distressed leather and diecast buckles provide a tough but functional saddlebag with a distinctive edgy style that exudes a youthful attitude. 3000 cubic inches of luggage capacity ensures you can carry what you need with you at all times. Quick-disconnect clips under the rugged buckles allow easy access to bag contents while always maintaining a sense of style.

90201306**\$659.95****C. SPORTSTER LEATHER SADDLEBAGS**

These saddlebags are constructed from 9 oz. leather with thermoformed backs for added shape retention. Bags feature an embossed Sportster script logo for style and quick-disconnect clips under traditional chrome buckles for easy access. Luggage capacity: 3000 cubic inches total.

90201329**\$684.95****D. RIGID LEATHER LOCKING SADDLEBAGS**

These premium textured leather saddlebags are ready to go the distance. The push-button latching swing-out lid is easy to operate with one hand and the fine leather surface and brushed chrome medallion add an elegant touch. The hard-shell design retains its shape in all kinds of weather and is covered in leather for a traditional look. Locking hinged lids offer modern convenience and security. Styled to complement the sleek, narrow Sportster® model profile, these bags offer plenty of storage for a trip across town or across the country. Kit includes reflectors. Luggage Capacity: 2400 cubic inches total.

90201321**\$729.95**

Fits '04-later XL models (except XL1200CX, XL1200T, XL1200V and International (non-Canadian) XL883N, XL1200N or XL1200X models and models with Rear Axle Covers). Models with side-mount license plates require License Plate/Turn Signal Relocation Kit P/N 73279-10. '11-later XL1200C models require Turn Signal Relocation Kit P/N 67800071 (Domestic) or 67800077 (International). All other models require separate purchase of Turn Signal Relocation Kit P/N 68732-02A (Domestic), 68733-02A (International) or Layback License Plate Kit P/N 60215-06. Models equipped with H-D Detachables accessories require separate purchase of Docking Hardware Kit P/N 53544-04 (if not already equipped).

NOTE: Some Harley-Davidson® saddlebags are made of leather. Fine leathers or other natural materials WILL gain "character," such as wrinkles or wear, with age. This is normal. A fine, aged patina and character wrinkles are a sign of the extremely high quality materials used to construct your saddlebags. The appearance of scars or marks on the leather are a result of using natural leather panels and should not be thought of as an imperfection. Please use Harley-Davidson Leather Protectant P/N 93600034 to protect your investment.

Notice: The prices appearing in this catalog are the manufacturer's suggested retail prices. Actual retail prices may vary.

84 SPORTSTER®

Saddlebags & Luggage

A. EXPRESS RIDER LARGE CAPACITY LEATHER SADDLEBAGS

Traditional Pony Express throw-over bag styling is enhanced with a modern rigid mounting structure on this handsome set of leather saddlebags. This Large Capacity Sportster® saddlebag offers the convenience of quick-release clips under conventional buckles for easy access. The riveted leather patch with embossed Bar & Shield logo completes the ageless look. Luggage capacity: 2400 cubic inches total.

90201325 **\$599.95**

Fits '04-later XL models (except XL1200CX, XL1200T, XL1200V and International (non-Canadian) XL883N, XL1200N or XL1200X models). Domestic XL883N, XL1200N and XL1200X models require License Plate/Directional Relocation Kit P/N 73279-10. '11-later XL1200C models require Directional Relocation Kit P/N 67800071 (Domestic) or 67800077 (International). All other models require separate purchase of Turn Signal Relocation Kit P/N 68732-02A (Domestic), 68733-02A (International) or Layback License Plate Kit P/N 60215-06. Models equipped with H-D Detachables accessories require separate purchase of Docking Hardware Kit P/N 53544-04 (if not already equipped). Does not fit with Rear Axle Covers or Bobtail Fender.



A. EXPRESS RIDER LARGE CAPACITY LEATHER SADDLEBAGS

B. SYNTHETIC LEATHER SADDLEBAGS

Combine street attitude with long-haul versatility and you get these custom bags. Styled with sweeping lines to complement the Sportster fender, these bags feature plenty of storage space for a ride to the store or to Sturgis. The rigid plastic tub, wrapped in rich synthetic leather, offers long-term durability. The traditional straps hide quick-disconnect closures for packing convenience and the chrome buckles provide a look that's pure Harley-Davidson. Luggage capacity: 2000 cubic inches total.

90330-08 **\$429.95**

Fits '04-later XL models (except XL1200T, '02-'03 XL883R, models equipped with Rear Axle Nut covers or Flat Lens Turn Signals and models equipped with 2-into-1 exhaust). '04-later models require separate purchase of Turn Signal Relocation Kit P/N 68732-02A (Domestic), P/N 68733-02A (International) or Layback License Plate Kit P/N 60215-06. '11-later XL1200C fitment requires purchase of Turn Signal Relocation Kit P/N 67800071 (Domestic) or 67800077 (International).



B. SYNTHETIC LEATHER SADDLEBAGS

C. BLACK STANDARD LINE THROW-OVER SADDLEBAGS

Made of ultra-durable leather-like synthetic featuring a debossed H-D #1 logo, the Black Standard Bags have a simple, black on black style that complements many styling directions and budgets. An internal reinforcement system maintains the bag's shape over time. The "MOLLE-style" system of mounting loops accommodate hook and loop straps and allow for multiple mounting locations and orientations. The bags feature matte black enamel buckles with hidden quick-detach buckles underneath. These Throw-Over bags feature side gussets for increased capacity and straight and perpendicular mounting loops for easy mounting. Quick-release buckles get you in and out of the bag fast. These Throw-Over Bags can be used with or without a passenger pillion. If used with a passenger pillion, the straps should be mounted under the pillion and the crossover straps feature a soft, non-scratch backing. Installation requires purchase of saddlebag support rails and may require the purchase of a turn signal relocation kit. Large bag measures: 16.5" L x 11.5" H x 7" D. Internal capacity: 1,350CI. Weight capacity: 10 lbs/bag. Compact bag measures: 10" L x 11.5" H x 5.25" D. Internal capacity: 600CI. Weight capacity: 6 lbs/bag.

Fits '82-later XL (except 1200T), '08-'17 Dyna® (except FLD), '84-'99 Softail®, and '18-later Softail models equipped with H-D® Saddlebag Supports. '18-later Softail models require purchase of Turn Signal Relocation Kit P/N 67800802 or 68700830.

90201770 Large. **\$269.95**
90201769 Compact. **\$219.95**



C. BLACK STANDARD LINE THROW-OVER SADDLEBAGS – LARGE

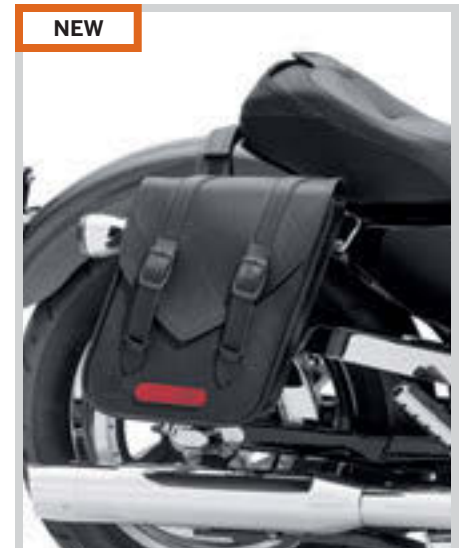

C. BLACK STANDARD LINE THROW-OVER SADDLEBAGS – COMPACT

NOTE: Some Harley-Davidson® saddlebags are made of leather. Fine leathers or other natural materials WILL gain "character," such as wrinkles or wear, with age. This is normal. A fine, aged patina and character wrinkles are a sign of the extremely high quality materials used to construct your saddlebags. The appearance of scars or marks on the leather are a result of using natural leather panels and should not be thought of as an imperfection. Please use Harley-Davidson Leather Protectant P/N 93600034 to protect your investment.



D. LEATHER THROW-OVER SADDLEBAGS



E. SADDLEBAG SUPPORTS – CHROME



E. SADDLEBAG SUPPORTS – GLOSS BLACK

D. LEATHER THROW-OVER SADDLEBAGS

These traditional Leather Throw-Over bags feature large side gussets for increased capacity and full-length straps with hidden quick-disconnect clips for easy access.

91008-82C Chrome. **\$369.95**
Fits '82-later XL (except XL1200T), '08-'17 Dyna® (except FLD) and '84-'99 and '18-later Softail® models equipped with H-D® Saddlebag Supports.

E. SADDLEBAG SUPPORTS

Keep your throw-over style saddlebags away from the wheel, swingarm and brake caliper. Can be installed on models equipped with rigid-mount sissy bar sideplates and uprights.

90201324 Chrome. **\$99.95**
Fits '00-later XL models (except XL1200CX, XL1200S, XL1200T and '02-'03 XL883R). Does not fit with H-D® Detachables™ accessories.

90799-94D Chrome. **\$99.95**
Fits '94-'15 XL models (except XL1200S, XL1200T and '02-'03 XL883R). Does not fit with H-D Detachables accessories. (Includes Chrome Upper Shock Covers P/N 54711-94.)

90201433 Gloss Black. **\$99.95**
Fits '00-later XL models (except XL1200S, XL1200T and '02-'03 XL883R). Does not fit with H-D Detachables accessories.

F. TOUR-PAK® LUGGAGE

Interior will hold one full face helmet or two half helmets. Kit includes backrest pad, interior rubber mat, hardware and instructions. Luggage capacity: 2500 cubic inches. Dimensions: 18.5" W x 17.0" D x 13.0" H. Racks and docking kits sold separately. International models may require separate purchase of License Plate Relocation Kit P/N 60095-00A.

53690-06A Smooth Vinyl. **\$524.95**
Fits '04-later XL (except XL883N, XL1200C, XL1200CX, XL1200N and XL1200T) equipped with Solo Tour-Pak® Rack, '00-'17 Softail® (except FLS, FLSS, FLSTNSE, FLSTSE, FXCW, FXCWC, FXS, FXSB, FXSBSE, FXSE, FXSTD and '09 FXSTSSE) equipped with H-D® Detachables™ Solo or Two-Up Tour-Pak Rack and '97-'13 Touring models equipped with H-D Detachables Two-Up or Solo Tour-Pak Racks.

G. H-D® DETACHABLES™ SOLO TOUR-PAK MOUNTING RACK**

The rack is designed to position the Tour-Pak for solo riding. Tour-Pak, Passenger Backrest Pad and Docking Hardware sold separately.

53655-04A **\$139.95**
Fits '04-later XL models equipped with solo seat (except XL883N, XL1200C, XL1200CX, XL1200N). Designed to accept Color-Matched Sport Tour-Pak P/N 53929-YYXXX, Leather Tour-Pak P/N 53151-00A, 53147-98B, 53018-04A or 53690-06A. Requires separate purchase of appropriate Docking Hardware.

H. SINGLE-SIDED SWINGARM BAG

These bags are constructed of heavyweight leather and feature a pouch-style flap lid that is secured with two quick-disconnect clips. The semi rigid-backed bag is secured to the left side of the bike with easy-to-install brackets and adjustable straps. Luggage capacity: 430 cubic inches total.

90201326A Black Leather. **\$199.95**
Fits '04-later XL models equipped with Solo Seats. Does not fit XL1200T. Requires removal of passenger pegs.

I. DOWN-TUBE BAG

Features traditional strap-and-buckle closures to provide both function and flair. Kit includes all required mounting hardware.

93300044 Black Leather. **\$149.95**
Fits '04-later XL, '08-'13 XR and '06-'17 Dyna models (except FLD). Does not fit XL models with engine guard. Does not fit XL models with Boom!™ Audio Cruiser Amp and Speaker Kit P/N 76262-08A or 76320-08A. Does not fit Dyna models with evaporative emissions canister (California and Asia-Pacific markets). Does not fit with Dyna Oil Cooler Kit P/N 26151-07B. Does not fit XL and Dyna models equipped with Front Spoilers.



F. TOUR-PAK LUGGAGE (SHOWN WITH H-D DETACHABLES SOLO TOUR-PAK MOUNTING RACK)



G. H-D DETACHABLES SOLO TOUR-PAK MOUNTING RACK



H. SINGLE-SIDED SWINGARM BAG – BLACK LEATHER



I. DOWN-TUBE BAG – BLACK LEATHER



****WARNING:** Do not use this rack as a seat. Do not exceed the fender rack weight capacity. Using as seat or exceeding this capacity could cause handling problems which could result in loss of control and death or serious injury.

Notice: The prices appearing in this catalog are the manufacturer's suggested retail prices. Actual retail prices may vary.

PREMIUM ADJUSTABLE SUSPENSION

Your motorcycle's suspension defines the riding experience. Fast starts, smooth stops, and tight control in the corners are all part of the vehicle dynamics controlled by the tuning of the front forks and rear shocks. Screamin' Eagle® Fully Adjustable Suspension components let you dial-in the ride, whether you're cruising the highway, carving up a country road, or dodging city potholes.



1 COMPRESSION ADJUSTER

Fine tunes suspension to control the upward wheel movement when hitting a bump

Adjusts the speed at which the suspension compresses

Critical for balancing ride quality and suspension bottoming

2 REBOUND ADJUSTER

Fine tunes the downward wheel movement after riding over bumps or potholes

Adjusts the speed at which the suspension returns from extension

Critical for balancing ride quality and suspension bounce

3 PRELOAD ADJUSTER

Critical to setting the proper suspension travel to soak up large potholes and absorb large bumps

Adjusts for rider sag—the amount the suspension drops under the weight of the rider and cargo

4 PIGGYBACK RESERVOIR

Remote reservoir keeps the shock oil cooler to maintain damping performance

Internal bladder separates the oil from the nitrogen gas to reduce cavitation during aggressive riding





A. SCREAMIN' EAGLE FULLY ADJUSTABLE FRONT FORK KIT

**A. SCREAMIN' EAGLE® FULLY ADJUSTABLE FRONT FORK KIT***

Experience the ultimate in handling and ride quality with these Screamin' Eagle® front forks. The forks are completely adjustable to match your individual riding style. Set the sag with the adjustable preload then fine tune the response with adjustable compression and rebound damping. These forks not only perform great, they add a performance look with the exposed anodized adjusters. When paired with the Screamin' Eagle adjustable rear shocks, you will experience the best handling Sportster® available.

45400176 \$699.95

Fits '04-later XL883, XL883C, XL883R, XL1200V, XL1200R, and '04-'10 XL1200C models. Also fits '10-later XL883N and '11-later XL1200C/CA/CB/CP models with the additional purchase of Screamin' Eagle Piggyback Shocks P/N 54000125, Jiffy Stand P/N 49722-08BHP and appropriate front brake line.

NOTE:

When installing H-D® Braided Two-Piece Modular Brake Lines, use the appropriate upper brake line for your handlebar, and the following lower brake lines:

Non-ABS Diamondback™.	41800412
Non-ABS Diamond Black.	41800413
ABS Diamondback.	41800416A
ABS Diamond Black.	41800417A



B. SCREAMIN' EAGLE FULLY ADJUSTABLE PIGGYBACK SHOCKS

**B. SCREAMIN' EAGLE FULLY ADJUSTABLE PIGGYBACK SHOCKS***

Experience the ultimate in handling and ride quality with these Screamin' Eagle piggyback shocks. The shocks are completely adjustable to match your individual riding style. Set the sag with the adjustable preload then fine tune the response with adjustable compression and rebound damping. These shocks not only perform great, they add a performance look with the piggyback canister, exposed anodized adjusters and Screamin' Eagle medallion. When paired with the Screamin' Eagle adjustable front forks, you will experience the best handling Sportster available.

54000125 \$899.95

Fits '04-later XL883, XL883N, XL883R, XL1200N, XL1200NS, XL1200R, XL1200OV, XL1200X and XL1200XS models. Also fits '07-'10 XL883L, '11-later XL1200C/CA/CB/CP and '08-'10 XL1200L models.

C. PERFORMANCE SUSPENSION KIT – XR1200

Maximize the canyon-carving ability of your XR1200 motorcycle with this complete Performance Suspension Kit. Fully-adjustable light-weight suspension system features Showa's new Big Piston Front fork (BPF) design. The BPF eliminates many of the internal components used in a cartridge-type fork, simplifying construction and resulting in lighter overall fork weight. The large-diameter of the BPF's internal piston allows a reduction in damping pressure, for better feedback and smoother action. This performance suspension kit also provides a very controlled feeling which leads to more rider confidence. The BPF's rebound and compression damping force settings are easily fine-tuned via two adjuster screws located on top of the fork bolts. The spring pre-load is adjusted via a M5 hex screw on the axle holders. The rear Showa® shocks feature 36mm pistons with piggyback nitrogen-charged reservoirs. The compression damping can be adjusted via a knob on top of the piggyback reservoir. The rebound is adjusted with a thumb wheel on the lower clevis. Rear spring pre-load is also adjustable on the shock for optimum 1G sag. The kit includes one set of Big Piston Front Forks and one set of rear shocks.

54530-10 \$1,499.95

Fits '08-'13 XR1200 models. Stock on '10-'13 XR1200X models. Does not fit with Sport Saddlebag Kit P/N 90328-08.



C. PERFORMANCE SUSPENSION KIT – XR1200



***WARNING:** Installation of any accessory suspension components may affect cornering clearance and jiffy stand operation. This could distract the rider, causing loss of control and death or serious injury.

Notice: The prices appearing in this catalog are the manufacturer's suggested retail prices. Actual retail prices may vary.

88 SPORTSTER®

Suspension

A. PREMIUM RIDE SINGLE CARTRIDGE FORK KIT*

This Single Sided Cartridge Fork provides improved handling performance by keeping the tire in contact with the road surface. Tuned to work in concert with the Premium Emulsion Rear Shocks, the fork damping is controlled by a specifically calibrated piston and valve stack. Unlike typical orifice damping, the piston/valve system helps the cartridge fork achieve a linear damping force curve for consistent feel throughout the compression and extension of the front suspension. The cartridge allows the forks to react quickly to rough roads, inspiring rider confidence in sweeping corners. The compression piston provides excellent low speed damping for a better rider feel, and the rebound spring provides a smoother feel during topping. The cartridge fork resists bottoming and dive, and the triple rate spring and oil lock allows the forks to absorb bumps even under hard braking – giving the rider more control while resisting wheel hop. A perfect addition during the installation of chrome or gloss black lower fork sliders, the kit includes fork pipe, cartridge, fork bolts, main springs and oil seals.

45400091 Standard Height. **\$349.95**
Fits '04-'15 XL883, XL883C, XL883R, XL1200R, and XL1200V and '04-'10 XL1200C models.

45400090 Low-Profile. **\$349.95**
Fits '11-'15 XL883, XL1200C and XL1200T and '06-'11 XL1200L models.



A. PREMIUM RIDE SINGLE CARTRIDGE FORK KIT (STANDARD HEIGHT)



A. PREMIUM RIDE SINGLE CARTRIDGE FORK KIT (LOW PROFILE)

B. PREMIUM RIDE EMULSION SHOCKS*

Experience a comfortable and confidence-inspiring ride – no matter the pavement conditions – with Harley-Davidson® Premium Ride Emulsion Shocks. These fast shocks offer enhanced compression and rebound damping control when compared to typical twin-tube shock absorbers. The nitrogen gas charged shocks resist oil aeration and work with the internal valve stack to provide superior damping control in the twisties. The large pistons and low viscosity high-performance oil allow these shocks to react quickly to impacts and keep the tires tracking the road surface. With the addition of urethane bumpers, you get a controlled ride and minimized bottoming harshness. The locking threaded adjustment lets you fine tune the spring preload to your current riding conditions – whether a solo run on the back roads or a fully-loaded two-up freeway tour. Kit includes left and right shock and preload adjustment spanner wrench.

54000076 Standard Height. **\$599.95**
Fits '04-'15 XL models (except XL883C, XL1200T, '11-'15 XL883L, '04-'11 XL1200C and '06-'07 XL1200L).

54000077 Low-Profile. **\$599.95**
Fits '04-'15 XL models (except XL883, XL883R, XL1200R and XL1200T).



B. PREMIUM RIDE EMULSION SHOCKS

C. TWO-UP PROFILE LOW REAR SHOCK KIT**

These heavy-duty shocks are tuned for the touring rider carrying a passenger or loaded saddlebags. Shock length and spring rate are engineered to maintain the factory low seat height. The chrome-bodied shocks feature adjustable preload for a comfortable, controlled ride.

54704-07 **\$234.95**
Fits '07-'15 XL883L, XL883N, XL1200N, XL1200V, XL1200X and '11-'15 XL1200C models.



C. TWO-UP PROFILE LOW REAR SHOCK KIT



***WARNING:** Installation of any accessory suspension components may affect cornering clearance and jiffy stand operation. This could distract the rider, causing loss of control and death or serious injury.



****WARNING:** The Profile Low Front Spring Kit cannot be used independently and must be used with the appropriate Profile Rear Shock Lowering Kit. Installation of any accessory suspension components may affect cornering clearance and jiffy stand operation. This could distract the rider, causing loss of control and death or serious injury.

Notice: The prices appearing in this catalog are the manufacturer's suggested retail prices. Actual retail prices may vary.

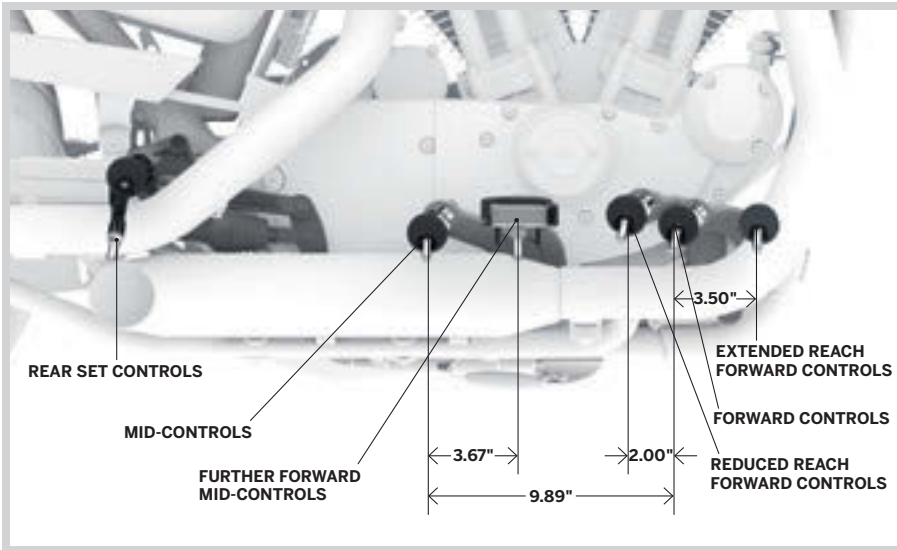

FOOT CONTROL POSITION COMPARISON

D. STANDARD FORWARD CONTROL KIT – CHROME
(50700020 SHOWN)D. STANDARD FORWARD CONTROL KIT – BLACK
(33397-07A SHOWN)**SPORTSTER® FOOT CONTROLS**

A long stretch to the controls or a knees-high cramped riding position puts strain on your body after even a short ride. Repositioning your feet on the controls relieves muscle tension, takes pressure off the tail bone, and reduces rider fatigue. Where your feet contact the controls can often determine how many miles you can put on in a day.

Many Sportster® models can be equipped with the following foot control configurations:

MID-CONTROLS:

Original Equipment on some models, Mid-Controls position the feet below the knee for a sporting riding posture.

FURTHER FORWARD MID-CONTROLS:

Achieves a comfortable foot-down riding position for the taller rider.

REDUCED REACH FORWARD CONTROLS:

Provides a foot-forward boulevard style without straining to reach the controls.

STANDARD FORWARD CONTROLS:

Places the legs for a "feet-in-the-wind" laid back profiling posture.

EXTENDED REACH FORWARD CONTROLS:

Accommodates the tallest rider by stretching the leg a full 3.5" further forward.

D. STANDARD FORWARD CONTROL KIT*

Add the stretched-out look and extended riding position to your Sportster® model. The complete kit includes all hardware necessary to convert your Sportster model from mid-controls to forward controls. Available in your choice of finishes, these forward controls add style and long range comfort. (Footpegs and shifter peg not included.)

Fits '14-later XL models. Requires separate purchase of stock or accessory rider position footpegs with wear pegs that fit '14-later XL1200 models.

50700020 Chrome with Black Peg Bracket. **\$474.95**

50700021 Black. **\$449.95**

Fits '06-'13 XL models with mid-controls (except XL1200CP and XL1200CA). XL1200L requires separate purchase of footpegs P/N 33134-07CAZ and 33135-07CAZ.

33395-06A Chrome. **\$474.95**

33397-07A Black. **\$449.95**

Fits '91-'03 XL (except XL883R). Does not fit with 2-into-1 Exhaust Systems. Current owners of Engine Guard P/N 49018-88A and 49018-88B will need to purchase bracket P/N 49014-86A for proper fitment (sold separately). This kit will not fit on vehicles equipped with an early style engine guard. Use Engine Guard Kit P/N 49018-88C when adjustable highway peg supports are installed.

33892-98 Polished. **\$449.95**



***WARNING:** Installation of accessory Forward Control Kits may affect cornering clearance. This could distract the rider, causing loss of control, resulting in death or serious injury.

Notice: The prices appearing in this catalog are the manufacturer's suggested retail prices. Actual retail prices may vary.

90 SPORTSTER®

Foot Controls

A. EXTENDED REACH FORWARD CONTROL CONVERSION KIT*

This kit extends the rider foot controls a full 3.5" forward, .9" out, and .375" up of the stock location, providing the tall rider a stretched out comfortable riding position. This comprehensive kit includes everything necessary for installation. The kit includes brake and shifter mounting brackets, brake lever, brake and shift linkage, replacement wear pegs, and all the required hardware. The kit is compatible with Original Equipment or accessory foot pegs, shifter pegs and small brake pedal pads.

50700030 **\$449.95**

Fits '14-later XL models with forward controls. Installation requires reuse of Original Equipment rider footpegs with wear peg or separate purchase of accessory footpegs with wear peg.



A. EXTENDED REACH FORWARD CONTROL CONVERSION KIT

B. REDUCED REACH FORWARD CONTROL CONVERSION KIT*

Love the look and riding position you get with forward controls but not comfortable with the long stretch forward? This Forward Control Conversion Kit repositions the Original Equipment footpegs and foot controls up and back by 2.0" and positions the controls closer to the rider for added comfort and confidence. This kit provides additional leg clearance around the chassis and air cleaner by moving the footpegs outward 1.5" (left) and 0.5" (right). The reduced reach places the rider's boot at the proper pivot point for improved leverage, while maintaining the "foot-forward" riding profile. This easy-to-install Conversion Kit includes heavy-duty steel mounts and shortened brake rod and reuses Original Equipment control supports and brake and shift levers or can be personalized with your choice of custom lever styles.

50700026 **\$274.95**

Fits '14-later XL models equipped with forward foot controls.



B. REDUCED REACH FORWARD CONTROL CONVERSION KIT

C. FURTHER FORWARD MID-CONTROL KIT

Feel a little cramped when your feet are placed on the standard-location mid-controls? This kit repositions the controls 3.0" forward of the stock location, eliminating the "knees-high" riding attitude while maintaining a sporty upright riding posture. The forward location provides an open path for your feet to aid maneuvering the bike while parking and improves access to the jiffy stand for a shorter rider. Kit includes control mounts, brake and shift levers, brake rod, mini-footboards with wear pegs and all hardware necessary to convert your mid- or forward-control equipped Sportster® model.

Fits '14-later XL models.

50700027 Chrome. **\$474.95**

50700028 Gloss Black. **\$449.95**



C. FURTHER FORWARD MID-CONTROL KIT – CHROME



C. FURTHER FORWARD MID-CONTROL KIT – GLOSS BLACK



***WARNING:** Installation of accessory Forward Control Kits may affect cornering clearance. This could distract the rider, causing loss of control, resulting in death or serious injury.

Notice: The prices appearing in this catalog are the manufacturer's suggested retail prices. Actual retail prices may vary.



D. ADJUSTABLE HIGHWAY PEG SUPPORT KIT

D. ADJUSTABLE HIGHWAY PEG SUPPORT KIT*

So you're not the average Sportster® motorcycle rider. But then again, there is nothing average about Harley-Davidson®. These chrome-plated Highway Peg Supports adjust easily and quickly into three height-accommodating positions. Use with your choice of H-D® small male mount-style footpegs (not included). Includes all necessary hardware.

49053-04A \$199.95
Fits '04-later XL models with mid controls (except XL1200C).

E. CUSTOM GEAR SHIFT LINKAGES

Kick your custom into gear with this collection of high-quality Custom Shift Linkages. Available in a variety of designs to match your bike's style, these linkages feature aircraft quality rod ends for easy adjustment and smooth operation. The easy-to-install linkage kit includes a transmission cover and decorative acorn nuts and bolts for a complete custom look.

Fits '04-later XL models equipped with standard forward controls.

1. 34840-09 Skull. \$109.95
2. 33778-09 Black Anodized Slotted. \$109.95

F. JIFFY STAND EXTENSION

Jiffy Stand Extension kits have been ergonomically designed to simplify the deployment and retraction of the jiffy stand. The extension is shaped to simplify locating the tab with your boot and aid in swinging the jiffy stand into position. The move feels natural and adds confidence when parking your motorcycle in a tight spot. Kit mounts to Original Equipment jiffy stand and includes all required mounting hardware.

50462-11 Black. \$34.95
Fits '07-later XL and '08-'13 XR models (except XL50, XL883C, XL1200L, XL1200T, XL1200V, '07-'08 XL883, XL883R and XL1200R and '09-'10 XL1200C). Does not fit '09-later XL883N, XL1200N, XL1200NS, XL1200X and XL1200XS for International markets AUS, BRZ, ENG and HDI.



E. CUSTOM GEAR SHIFT LINKAGES



F. JIFFY STAND EXTENSION – BLACK



***WARNING:** Do not use highway pegs under normal stop and go operating conditions. Doing so could result in death or serious injury.

Notice: The prices appearing in this catalog are the manufacturer's suggested retail prices. Actual retail prices may vary.

92 SPORTSTER®

Foot Controls

A. PASSENGER FOOTPEG MOUNT KIT – BLACK

A necessary addition when converting your solo seat Sportster® model to a two-up passenger-carrying ride. Kit includes black mounting brackets, Kit includes Original Equipment-style footpegs and all necessary mounting hardware.

50500270 **\$114.95**

Fits '14-later XL models.

50203-04 **\$114.95**

Fits '04-'13 XL models.



A. PASSENGER FOOTPEG MOUNT KIT – BLACK

B. ADJUSTABLE PASSENGER FOOTPEG MOUNT KIT

Maximize your passenger's riding comfort. Proper foot position reduces the cramped or stretched-out feeling and relieves pressure on the knees and the tailbone. These Adjustable Mounts raise and lower the passenger footpeg to accommodate taller and shorter passengers. Easy to adjust with common tools, the mount adjusts through a 360° range (depending on model), allowing both fore and aft and up and down height adjustment. Kit includes left and right adjustable support assembly and all required mounting hardware. Footpegs sold separately.

50763-09 **\$149.95**

Fits models with H-D® male mount-style passenger footpeg supports (except Softail® models). Does not fit with Heel Raiser Footpeg Kit P/N 50178-09. Does not fit the rider position.



B. ADJUSTABLE PASSENGER FOOTPEG MOUNT KIT

C. MINI FOOTBOARD KIT

This footboard kit can be installed in place of traditional footpegs and provides a little additional leg support and more options to move your legs around on a long ride. Mini Footboards mount to the standard H-D® style footpeg supports and can be used in many rider, passenger and highway peg applications. Sole-gripping rubber complements Original Equipment or accessory footboards and footpegs and adds vibration isolation and a rich appearance.

Fits rider position:

'02-'17 VRSC™ models with forward controls (except VRSCDX and VRSCF), '15-later XG models (except XG750A), '06-earlier XL, '07-'10 XL883, XL883R, XL883C, XL1200C and XL1200R and '07-'11 XL1200L, '91-'17 Dyna® (except FLD) and '84-'17 Softail models with forward controls (except FXCW, FXCWC, FXS, FXSB or FXSBSE).

Fits passenger position:

All models with H-D male-mount passenger peg mounts (except '06-earlier VRSC, '03-earlier XL, '05-earlier Dyna and Softail models equipped with Shotgun exhaust). '84-'17 Softail models require separate purchase of Support Kit P/N 50454-09. Does not fit passenger position on '18-later Softail models.

Fits highway peg position:

All models with frame-mount or engine guard-mount highway pegs (except Whiskers Adjustable Highway Bar P/N 50855-09 and 50865-09).

50500139 Small 3.0" – Chrome. **\$129.95**

50500144 Small 3.0" – Gloss Black. **\$129.95**

50500109 Large 4.0" – Chrome. **\$129.95**

50500124 Large 4.0" – Gloss Black. **\$129.95**



C. MINI FOOTBOARD KIT – LARGE CHROME

C. MINI FOOTBOARD KIT – LARGE GLOSS BLACK



C. MINI FOOTBOARD KIT

Notice: The prices appearing in this catalog are the manufacturer's suggested retail prices. Actual retail prices may vary.



D. ENGINE GUARD – CHROME



D. ENGINE GUARD – GLOSS BLACK



E. MUSTACHE ENGINE GUARD – CHROME



E. MUSTACHE ENGINE GUARD – GLOSS BLACK



F. SOFT LOWERS



F. SOFT LOWERS

D. ENGINE GUARD*

The unique soft curve shape adds style to function. The one-piece Engine Guard is designed to complement the lines of the Sportster® motorcycle and the choice of finishes adds the perfect finishing touch. Add your choice of Engine Guard Mounted Highway Pegs (sold separately) to change your foot position on a long ride.

Fits '04-later XL and XR models (except XL1200CX, XL1200T, '16-later XL1200X, '18-later XL1200XS and '11-later XL883L). (Will not fit with Front Spoilers.)

49060-04 Chrome. **\$219.95**

49215-07 Gloss Black. **\$219.95**

Fits '11-later XL883L and '14-'17 XL1200T models. (Will not fit with Front Spoilers.)

49287-11 Chrome. **\$219.95**

Also available: (not shown)

ENGINE GUARD*

This highly-polished, chrome-plated guard matches stock plating and works great with the Sportster Forward Controls.

49018-88C Chrome. **\$219.95**

Fits '82-'03 XL models. '82-early '84 models require Bracket P/N 49014-85. (Will not fit with Front Spoilers.)

E. MUSTACHE ENGINE GUARD*

Combine classic shape and modern function for a unique twist on engine protection. The flow of this Engine Guard complements the bike's traditional style while the gracefully curved upper section incorporates highway pegs into the shape. The integrated rubber pads offer a comfortable and slip-resistant cushion for your feet while traveling the open road. One-piece engine guard kit includes all required mounting hardware.

Fits '04-later XL and '08-'13 XR models. (Will not fit with Front Spoilers.)

49000005 Chrome. **\$289.95**

49000006 Gloss Black. **\$289.95**

F. SOFT LOWERS

Extend your riding season. Full coverage Soft Lowers provide wind and mud protection for the rider's legs and boots and minimize cold updrafts as the weather changes. Covers are custom shaped to hug the engine guard to minimize flapping and they clip in place for speedy installation as the weather changes. Two-way zippered outer edge accommodates guard-mounted highway pegs in almost any position. Reflective piping provides added visibility and convenient zippered pockets provide additional storage for maps or other small items.

57100211 **\$94.95**

Fits '04-later XL models (except '11-later XL883L, '14-'17 XL1200T, '16-later XL1200X and '18-later XL1200XS) equipped with Engine Guard P/N 49060-04 or 49215-07. Does not fit Mustache Engine Guards.



***WARNING:** Engine guards may provide limited leg and cosmetic vehicle protection under unique circumstances (fall over while stopped, very low speed slide). They are not made nor intended to provide protection from bodily injury in a collision with another vehicle or any other object.



***WARNING:** Do not use engine guard footpegs under normal stop and go operating conditions. Doing so could result in death or serious injury.

Notice: The prices appearing in this catalog are the manufacturer's suggested retail prices. Actual retail prices may vary.

94 SPORTSTER®

Chassis Trim — Front End

A. LOWER FORK SLIDERS – GLOSS BLACK

These gloss black coated sliders are the ultimate extension of your bike's "dark side" and make a perfect custom addition to your blacked-out ride. Manufactured to Original Equipment specifications, the durable black coating is a great match to other H-D® black components.

45500261 **\$429.95**
Fits '14-later XL883L and XL1200T models.

Shown with:

GLOSS BLACK FRONT AXLE NUT COVERS

43000026 Gloss Black – Die-cast. **\$29.95**
43428-09 Gloss Black – Billet. **\$44.95**

B. LOWER FORK SLIDERS – CHROME

Competitively priced, these chrome-plated Lower Fork Sliders give your bike upfront style. Form follows function, with polished triple chrome-plating and a stamped Harley-Davidson script logo for product identification. A perfect addition during the installation of Performance Front suspension components. To ensure proper fitment and function, these sliders are manufactured from Original Equipment components.

45500258 **\$429.95**
Fits '14-later XL883L and XL1200T models.

45500226 **\$429.95**
Fits '11-later XL1200C models. Does not fit XL1200CX.

45500238 **\$429.95**
Fits '14-'16 XL1200V models.

46562-04A **\$429.95**
Fits '08-'11 XL1200L, '12-'13 XL1200V and '08-'10 XL models (except XL883N, XL883R, XL1200N, XL1200R and XL1200X).

Shown with:

CHROME FRONT AXLE NUT COVERS

44117-07A Chrome – Die-cast. **\$29.95**
44116-07A Chrome – Billet. **\$44.95**

Also available:

Fits '88-'07 XL, '91-'03 FXD, FXDX, FXDXT, FXDL, FXDS-CONV, '93-'05 FXDWG, '88-'07 FXR, '87-later FLXR, FXRS-SP and FXWG, '84-'06 Softail® (except Springer™ and FXSTD) and '80-'99 Touring models.

43899-86A Chrome – Die-cast. **\$29.95**



A. LOWER FORK SLIDERS – GLOSS BLACK



B. LOWER FORK SLIDERS – CHROME

Notice: The prices appearing in this catalog are the manufacturer's suggested retail prices. Actual retail prices may vary.



NEW

C. DOMINION FRONT AXLE NUT COVERS – GLOSS BLACK

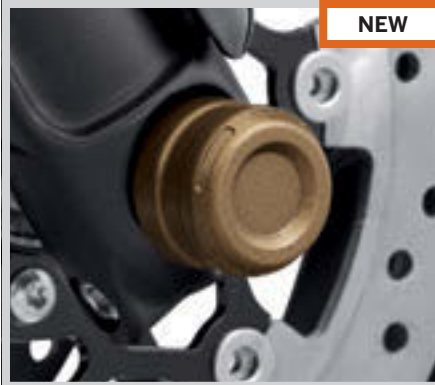

NEW

C. DOMINION FRONT AXLE NUT COVERS – BRONZE

FRONT AXLE NUT COVERS

Fits '02-'11 VRSC™ (except VRSCF and VRSCR), '15-later XG, '08-later XL, '08-'17 Dyna®, '07-later Softail® (except Springer™, FLSTNSE, FXCW, FXCWC, FXSB, FXSBSE, FXSE, FXST-Aus, and FXSTD) and '08-later Touring and Trike models. '18-later FLDE, FLFB, FLFBS, FLHC, FLHCS, FLSL, FXBB, FXBR, FXBRS and FXLR models require separate purchase of Front Axle Adapter Kit P/N 43000090. '19-later FXDRS and '18-later FXFB and FXFBS models require separate purchase of Front Axle Adapter Kit P/N 43000159.

C. DOMINION™ COLLECTION FRONT AXLE NUT COVERS

Express your bold, renegade attitude. The machined aluminum Dominion™ Collection Front Axle Nut Covers add style to the front of the bike and are the perfect complement to other Dominion Collection accessories.

43000124	Gloss Black.	\$74.95
43000123	Bronze.	\$74.95

D. H-D® MOTOR CO. LOGO FRONT AXLE NUT COVERS

Die-cast, chrome-plated covers feature the Harley-Davidson Motor Co. logo in black. Includes Allen®-head set screws and wrench for easy installation.

44148-07A		\$31.95
------------------	--	----------------

E. BURST COLLECTION FRONT AXLE NUT COVERS

Rich black and prismatic machined surfaces provide the contrast and the race-track ridges and the inner spider design make a powerful visual statement. Includes mounting hardware.

43000031		\$69.95
-----------------	--	----------------

F. SATIN CHROME FRONT AXLE NUT COVERS

The rich satin chrome finish of these Front Axle Covers is the perfect match for the satin-finished components on the '18 Fat Boy® model, and a great complement to Original Equipment polished or blacked-out fork sliders as well. Includes all necessary mounting hardware. Sold in pairs.

43000098		\$29.95
-----------------	--	----------------

G. DEFIANCE COLLECTION FRONT AXLE NUT COVERS

Deep radial grooves and a contemporary H-D logo define the style Defiance Collection Front Axle Nut Covers. Available in your choice of chrome or black machine cut finish. Easy to install. Sold in pairs.

43000062	Chrome.	\$74.95
43000064	Black Machine Cut.	\$74.95

H. FRONT AXLE NUT COVERS – BRASS COLLECTION

Artistically manufactured from solid brass, these components feature a natural antique finish that will age and patina when exposed to the elements. Brass Collection Axle Nut Covers look great with Original Equipment satin-finish fork sliders or as the finishing touch to a blacked-out front end. Includes all necessary mounting hardware. Sold in pairs.

43000046		\$54.95
-----------------	--	----------------

Fits '02-'11 VRSC (except VRSCF and VRSCR), '15-later XG, '08-later XL (except '16-later XL1200X and XL1200XS), '08-'17 Dyna, '07-later Softail (except Springer, FLSTNSE, FLSE, FXCW, FXCWC, FXDRS, FXFB, FXFBS, FXSB, FXSBSE, FXSE, FXST-Aus, and FXSTD) and '08-later Touring and Trike models. '18-later Softail models require separate purchase of Front Axle Adapter Kit P/N 43000090.

I. WILLIE G SKULL FRONT AXLE NUT COVERS

Penned at the hand of Willie G, the famous Skull Collection adds a little attitude to your ride. Completely drenched in black or chrome with black filled accents, the raised skull and surrounding Harley-Davidson Motorcycle script adds a subtle ominous touch to your ride. Easy to install. Includes all necessary mounting hardware. Sold in pairs.

Fits '02-'11 VRSC (except VRSCF and VRSCR), '15-later XG, '08-later XL (except '16-later XL1200X and XL1200XS), '08-'17 Dyna, '07-later Softail (except Springer, FLSTNSE, FXCW, FXCWC, FXSB, FXSBSE, FXSE, FXST-Aus, and FXSTD) and '08-later Touring and Trike models. '18-later FLDE, FLFB, FLFBS, FLHC, FLHCS, FLSL, FXBB, FXBR, FXBRS and FXLR models require separate purchase of Front Axle Adapter Kit P/N 43000090. '19-later FXDRS and '18-later FXFB and FXFBS models require separate purchase of Front Axle Adapter Kit P/N 43000159.

43000096	Black.	\$34.95
43163-08A	Chrome.	\$34.95

Notice: The prices appearing in this catalog are the manufacturer's suggested retail prices. Actual retail prices may vary.



FRONT AXLE NUT COVERS



NEW

I. WILLIE G SKULL FRONT AXLE NUT COVERS – BLACK



I. WILLIE G SKULL FRONT AXLE NUT COVERS – CHROME

96 SPORTSTER®

Chassis Trim — Front End

A. DOMINION™ COLLECTION FORK STEM COVERS

Top it off with style. These easy to install Fork Stem Covers top off the triple tree for a cohesive look. A perfect complement to other Dominion™ Collection Accessories, these Fork Nut Covers provide the finishing touch to your bike's front end. Sold in pairs.

Fits '06-'17 Dyna® models (except FXDB and FXDSE) and '18-later Softail® models (except FXDRS, FXFB, FXFBS, and FLSB). Also fits '88-'13 XL (except XL1200CX, XL1200X, XL883N) '95-'05 FXD, '93-'05 FXDL, '16-later FXDLS, '94-'05 FXDS-CONV, '90-'17 FLS, FLSS, FLSTF, FLSTFB, FLSTFBS and FLSTN, and '86-'17 FLSTC models.

45800117	Gloss Black.	\$74.95
45800118	Bronze.	\$74.95



A. DOMINION COLLECTION FORK STEM COVERS – GLOSS BLACK



A. DOMINION COLLECTION FORK STEM COVERS – BRONZE

B. DEFIANCE COLLECTION UPPER FORK STEM COVERS

Top it off with style. These easy to install Fork Stem Covers continue the Defiance Collection to the top of the triple tree for a cohesive look. The deep radial grooves define the style of the Defiance Collection, and the choice of chrome, black or machine cut finishes complement your bike's polished, chrome or blacked-out front end components. Sold in pairs.

Fits '06-'17 Dyna models and '18-later Softail models (except FXDRS, FXFB, FXFBS, and FLSB). Also Fits '88-'13 XL (except XL1200CX, XL1200X, XL883N) '95-'05 FXD, '93-'05 FXDL, '16-later FXDLS, '94-'05 FXDS-CONV and '90-'17 FLS, FLSS, FLSTF, FLSTFB, FLSTFBS and FLSTN and '86-'17 FLSTC models

45500514	Chrome.	\$49.95
45500515	Gloss Black.	\$49.95
45500516	Black Machine Cut.	\$59.95



B. DEFIANCE COLLECTION UPPER FORK STEM COVERS – CHROME



B. DEFIANCE COLLECTION UPPER FORK STEM COVERS – GLOSS BLACK

C. UPPER FORK STEM COVERS – BRASS COLLECTION

The ideal addition to your stripped down bobber or café bike build, these easy-to-install solid brass covers hide the Original Equipment fork and steering stem hex-head hardware and add a clean custom touch. Artistically manufactured from solid brass, these Upper Fork Covers feature a natural antique finish that will age and patina when exposed to the elements. Kits include mounting hardware.

45500308 Three-Piece Kit. **\$79.95**
Fits '88-'13 XL (except XL883C, XL1200C and XL1200S), '95-'05 FXD, '93-'05 FXDL, '94-'05 FXDS-Conv, and '90-'17 FLS, FLSS, FLSTF, FLSTFB, FLSTFBS, and FLSTN and '86-'17 FLSTC models.

45800113 Two-Piece Fork Stem Cover Kit. **\$59.95**
Fits '14-later XL (except XL1200CX) '18-later Softail models (except FXFB and FXFBS), '90-'17 FLS FLSS, FLSTF, FLSTFB, FLSTFBS and FLSTN models and '86-'17 FLSTC models.



B. DEFIANCE COLLECTION UPPER FORK STEM COVERS – BLACK MACHINE CUT



C. UPPER FORK STEM COVERS – BRASS COLLECTION

D. UPPER FORK STEM COVERS – CHROME

Highlighted with a unique Bar & Shield logo, these polished triple chrome-plated covers add an additional clean-looking appearance to your upper fork. Kit comes complete with three covers, mounting hardware and wrench for easy on-the-spot installation.

46129-98B **\$59.95**
Fits '88-'13 XL (except XL883C, XL1200C and XL1200S), '95-'05 FXD, '93-'05 FXDL, '16-'17 FXDLS, '94-'05 FXDS-CONV and '90-'17 FLS, FLSS, FLSTF, FLSTFB, FLSTFBS, and FLSTN and '86-'17 FLSTC models.

E. SCREAMIN' EAGLE® FORK BRACE – CHROME

This Chrome Fork Brace is machined from billet aluminum, then polished and chrome-plated. Easy to install, this brace offers increased torsional rigidity.

46192-99A **\$229.95**
Fits '87-later XL (except XL883N, XL883L, XL1200CX, XL1200N, XL1200NS, XL1200T, XL1200X, XL1200XS and '11-later XL1200C), '91-'05 Dyna® (except FXDWG) and FXR models (except FXRT) with 39mm front forks. (Will not fit with Chrome Fork Sliders).



D. UPPER FORK STEM COVERS – CHROME

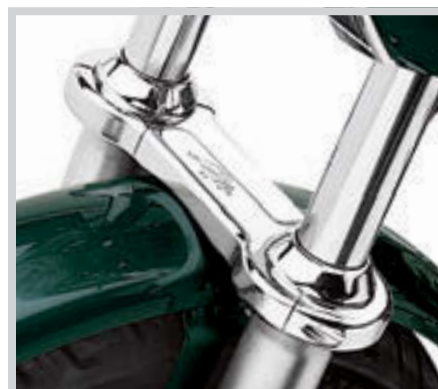

E. SCREAMIN' EAGLE FORK BRACE – CHROME

Notice: The prices appearing in this catalog are the manufacturer's suggested retail prices. Actual retail prices may vary.



F. UPPER BELT GUARD – CHROME
(SHOWN WITH CHROME LOWER BELT GUARD AND SWINGARM)

F. UPPER BELT GUARD – CHROME

Attract attention to your Sportster® motorcycle by replacing the black Original Equipment component, providing exceptional chrome-plated detail to the rear drive system. Easy to clean and simple to install.

60402-04A Fits '04-later XL models.

\$89.95

G. LOWER BELT GUARD – CHROME

This handsome steel cover is polished, chrome-plated and designed to replace the Original Equipment black plastic cover. Easy to install, this guard looks great when combined with a Harley-Davidson® Chrome Upper Belt Guard.

57100226 Fits '04-later XL models.

\$99.95

H. SWINGARM – CHROME

The ultimate chrome accessory, polished to the highest standard using bright plating to match Original Equipment chrome. Affordable and convenient, with no troublesome exchanges necessary. Factory specifications guarantee exact fitment, unparalleled quality and an affordable price. Stamped with the Harley-Davidson Bar & Shield logo.

48434-05A

Fits '05-later XL models (except XL1200T).

\$249.95

I. BUCKSHOT UPPER BELT GUARD – GLOSS BLACK

Add the blacked-out look of the Nightster® motorcycle to your Sportster model. The perforated Buckshot design visually lightens the belt guard and adds a raw, purposeful edge to the bike's profile.

60379-09A

Fits '04-later XL models.

\$94.95

J. BUCKSHOT LOWER BELT GUARD – GLOSS BLACK

This handsome gloss black steel guard replaces the Original Equipment plastic debris deflector to provide a rich smooth surface that complements the upper belt guard and swingarm. The perforated Buckshot design adds an open look while protecting the belt from stones and debris.

57100297

Fits '04-later XL models.

\$99.95



G. LOWER BELT GUARD – CHROME



H. SWINGARM – CHROME



I. BUCKSHOT UPPER BELT GUARD – GLOSS BLACK



J. BUCKSHOT LOWER BELT GUARD – GLOSS BLACK



98 SPORTSTER®

Chassis Trim — Rear End

A. BAR & SHIELD LOGO REAR AXLE COVERS

Die-cast cover conceals the side of the swingarm and axle. Unique styling features an embossed Bar & Shield logo. Easy to install without removing the rear wheel. Kit includes all necessary mounting hardware.

Fits '05-later XL883C, XL883L, XL883N, XL1200C, XL1200CX, XL1200L, XL1200N, XL1200NS, XL1200V, XL1200X and XL1200XS models. Also fits '05-later XL models equipped with Low Rear Suspension Kit P/N 54731-04, 54733-04 or 54750-05. (Will not fit models equipped with saddlebags or Chrome Billet Shock Hardware Kit P/N 54337-05.)

46399-05A	Chrome.	\$54.95
43013-09A	Gloss Black.	\$54.95



A. BAR & SHIELD LOGO REAR AXLE COVERS – CHROME

A. BAR & SHIELD LOGO REAR AXLE COVERS – GLOSS BLACK

B. REAR AXLE NUT COVERS – BRASS COLLECTION

Cover your rear axle nut in the most traditional way. Artistically manufactured from solid brass, these components feature a natural antique finish that will age and patina when exposed to the elements. Brass Collection Rear Axle Nut Covers complement the matching Front Axle Nut covers. Easy to install kits include all necessary mounting hardware. Sold in pairs.

43000057		\$54.95
-----------------	--	----------------

Fits '12-later XL models.



B. REAR AXLE NUT COVERS – BRASS COLLECTION

C. SWINGARM PIVOT BOLT COVERS – BRASS COLLECTION (61400344 SHOWN)

C. SWINGARM PIVOT BOLT COVERS – BRASS COLLECTION

Styled to complement the complete Brass Collection, these easy to install components hide the swingarm pivot bolt in classic style. Manufactured from solid brass, these heritage-finished covers feature a natural antique finish that will age and patina when exposed to the elements. Kit includes mounting hardware.

61400344	Left Side Only.	\$34.95
Fits '14-later XL and '18-later Softail® models.		
61400517	Right Side Only.	\$34.95
Fits '14-later XL models.		

D. SWINGARM PIVOT BOLT COVERS – WILLIE G SKULL COLLECTION

Add a little attitude to your ride. Styled to complement Harley-Davidson® Skull accessory items, the menacing raised skull with black-filled eyes leaps from a field of chrome. The surrounding Harley-Davidson Motorcycles script is the perfect finishing touch. This easy-to-install kit includes left and right pivot bolt covers and necessary mounting hardware.

42072-07	Fits '04-'13 XL models.	\$31.95
-----------------	-------------------------	----------------



C. SWINGARM PIVOT BOLT COVERS – BRASS COLLECTION (61400517 SHOWN)

D. SWINGARM PIVOT BOLT COVERS – WILLIE G SKULL COLLECTION

E. SHOCK BOLT COVERS

It's the details that complete the look of your bike. These Shock Bolt Covers are designed to hide the upper shock mounting hardware and provide a custom look to the rear of your bike. Easy-to-install, the kit includes left and right bolt covers and all required mounting hardware.

Fits '04-'16 XL and '06-'17 Dyna® models (except FLD, FXDF, FXDL and FXDLS). Does not fit with H-D® Detachable™ Leather Saddlebag Kit P/N 90181-08A.

54000016	Chrome.	\$39.95
54000017	Gloss Black.	\$39.95



E. SHOCK BOLT COVERS – CHROME

E. SHOCK BOLT COVERS – GLOSS BLACK

Notice: The prices appearing in this catalog are the manufacturer's suggested retail prices. Actual retail prices may vary.

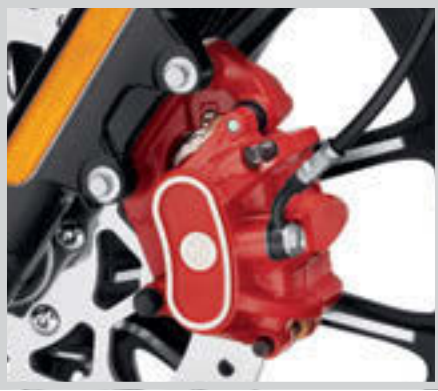

F. BRAKE CALIPER KIT – RED (41300134 SHOWN)



F. BRAKE CALIPER KIT – RED

Dress your bike in the latest high-performance look. Brilliant red calipers make a powerful visual statement and set your bike apart from the ordinary. Manufactured from Original Equipment components for proven performance, these calipers will add a stylish touch to the stock bike or add the perfect finish to a complete custom equipped with chrome or blacked-out wheels, rotors and fork sliders.

41300134 Front & Rear Kit. **\$399.95**
Fits '14-later XL models equipped with single disc front brakes. Kit includes one front and one rear caliper. Includes brake pads.

G. BRAKE CALIPER KIT – CHROME

Add the shine of chrome to your front end with this highly-polished Chrome Front Brake Caliper Kit. Manufactured from Original Equipment components for proven performance, these calipers are a great addition to the stock front end or they add the finishing touch to a complete custom with chrome wheels, rotors and chrome fork sliders.

44395-00A Front – Single Disc. **\$389.95**
Fits '00-'03 XL, '00-'07 Dyna® and '00-'07 Softail® models (except Springer) equipped with single disc front brakes. Brake pads sold separately.

44392-00A Front – Dual Disc. **\$799.95**
Fits '02-'05 VRSC™, '00-'03 XL, '00-'07 Dyna and '00-'07 Touring models equipped with dual disc front brakes. Brake pads sold separately.

H. BRAKE CALIPER INSERTS – WILLIE G SKULL

Easy-to-install inserts add a finishing touch to the front and rear brake calipers. Self-adhesive backing.

42070-07 **\$16.95**
Fits front and rear calipers on '04-'13 XL models.

I. SPROCKET HARDWARE – CHROME HEX HEAD

This kit includes highly-polished, chrome-plated, grade 8 hex head screws with chrome-plated washers, providing an extra custom accent. The perfect addition to the chrome sprocket. Made from the same Original Equipment bolts to ensure product integrity. Also works with chrome belt sprocket covers and Original Equipment sprockets.

94708-98 **\$29.95**
Fits '91-later XL and '93-'99 Dyna and Softail models.

J. REAR SPROCKET BOLT COVER KIT

These chrome-plated covers with internal spring clips hide the Original Equipment sprocket bolts for a clean, custom look. Set of 5 covers.

43876-04 **\$39.95**
Fits '04-later XL, '93-'17 Softail and '99-later Touring models with Original Equipment 7/16" hex head sprocket mounting bolts (5/8" hex across the flats).



G. BRAKE CALIPER KIT – CHROME (44395-00A SHOWN)



G. BRAKE CALIPER KIT – CHROME (44392-00A SHOWN)



H. BRAKE CALIPER INSERTS – WILLIE G SKULL COLLECTION



I. SPROCKET HARDWARE – CHROME HEX HEAD



J. REAR SPROCKET BOLT COVER KIT



Notice: The prices appearing in this catalog are the manufacturer's suggested retail prices. Actual retail prices may vary.

100 SPORTSTER®

Oil Cooler & Gauges

A. PREMIUM OIL COOLER KIT

This oil cooler was designed specifically for Harley-Davidson to out-perform all other coolers in the industry. The cooler features a unique "Turbulator" system that evenly distributes oil across the cooling chambers. The air fins are designed to efficiently dissipate heat. The oil cooler has been designed to simplify installation and enhance performance. Kit comes complete with mounting hardware and precut oil lines.

62700082 Side-Mount. **\$329.95**
Fits '04-later XL models. Does not include an integrated thermostat.

B. COMBINATION DIGITAL SPEEDOMETER/ANALOG TACHOMETER – 4"

Maintain the clean view over the handlebar. This unique Combination Speedometer/Tachometer allows you to monitor engine speed without adding additional handlebar-mounted gauges. The unit mounts in the stock dash opening and is a direct plug-in installation. The backlit gauges include a large LCD (liquid crystal display) information screen that displays odometer/tripmeter data, miles-to-empty readings, an easy-to-read segmented fuel display, a gear position indicator and clock. This valuable information is available to the rider at a glance. The gauge features push-button adjustable backlighting with over 600 color tone options, allowing the rider to adjust pointer, LCD and backlighting colors to match any paint scheme or viewing preference. The digital speed reading can be easily toggled between MPH and kph to simplify cross-border travel. Mileage reinstatement resides in the vehicle ECM so initial mileage will be uploaded at the time of installation.

NOTE: As a result of different vehicle capabilities, the following exceptions apply: Gear position not available on '04-'07 models, Range function not available on '04-'06 XL models and '04-'08 Dyna® models, Fuel level function not available on '04-'06 XL models.

70900475 Spun Aluminum Dial, MPH/km/h **\$314.95**
U.S. models. Fits '14-later XL, '12-'17 Dyna and '11-'17 Softail® models equipped with 4" speedometer. XL models require separate purchase of Fuel Sensor Kit P/N 61200008A to make use of the fuel level and range function.

70900100C Spun Aluminum Dial, MPH/km/h **\$314.95**
Non-U.S. models. Fits '14-later XL, '12-'17 FXDB and FXDWG, '11-'17 FXCWC, FXS and FXSB models with 4" speedometer. XL models require separate purchase of Fuel Sensor Kit P/N 61200008A for fuel level and range function.

70900274 Spun Aluminum Dial, MPH/km/h **\$314.95**
Worldwide Models. Fits '04-'13 XL (except XR, XL50 and '04-'08 XL1200R), '04-'11 Dyna models with 4" speedometer and '08-'10 FXCW and FXCWC models. '07-'13 XL models require separate purchase of Fuel Sensor Kit P/N 61200008A to make use of the fuel level and range function. Does not fit XL883 models equipped with Screamin' Eagle® 1200cc Stage I Conversion Kit P/N 29784-07 and 30003-10.

C. SPORTSTER® FUEL GAUGE KIT*

Keep an eye on your Sportster® model fuel level without watching how many miles you have traveled. In-tank sending unit employs capacitive sensing technology to accurately monitor the fuel level and relays the information to a handlebar-mounted LED indicator. The segmented LED display is set into a distinctive housing that replaces the brake master cylinder cover on the right hand control. The individual LED segments glow when the tank is full and count down one-by-one as the fuel level drops. Kit includes sending unit, LED master cylinder cover, wiring harness and all necessary installation hardware.

75031-09 Black. **\$299.95**
Fits '07-later XL and '08-'13 XR models. '14-later XL models require separate purchase of Electrical Connection Kit 72673-11.

*Some local regulations prohibit using colored lights during vehicle operation on public streets. May not conform to local lighting regulations.



A. PREMIUM OIL COOLER KIT



B. COMBINATION DIGITAL SPEEDOMETER/ANALOG TACHOMETER – 4"



C. SPORTSTER FUEL GAUGE KIT – BLACK

Notice: The prices appearing in this catalog are the manufacturer's suggested retail prices. Actual retail prices may vary.

SPORTSTER® 101

Chassis Trim



D. OIL LEVEL AND TEMPERATURE DIPSTICK WITH LIGHTED LCD READOUT – CHROME



D. OIL LEVEL AND TEMPERATURE DIPSTICK WITH LIGHTED LCD READOUT – GLOSS BLACK



E. OIL DIPSTICK WITH TEMPERATURE GAUGE – '04-LATER SPORTSTER



E. OIL DIPSTICK WITH TEMPERATURE GAUGE – '82-'03 SPORTSTER



F. DIPSTICK BEZEL – GLOSS BLACK



D. OIL LEVEL AND TEMPERATURE DIPSTICK WITH LIGHTED LCD READOUT

New and improved capacitive level sensing technology provides the highest degree of accuracy and durability. Now available in chrome and black, these dipsticks allow you to check your oil level and oil temperature with the push of a button. Add function and style by replacing your stock dipstick with this hard working version. No more grabbing a rag to pull your hot dipstick. No more oil drips on your pipes and on the garage floor. These stylish yet hard-working dipsticks allow you to check your oil level and oil temperature with the push of a button. Simply push the button and this dipstick lights up with a brilliant backlight. Oil level is indicated by a four-segment readout – it even reminds you to check your oil when it is hot. Capacitive level sensing technology provides the highest degree of accuracy and durability. The waterproof LCD (liquid crystal display) readout operates on a long-lasting, replaceable lithium coin-type battery (P/N 91800066). Display features a low battery indicator and press-and-hold feature to toggle between Fahrenheit and Celsius.

Fits '04-later XL and XR models.

62700009	Chrome.	\$149.95
62700011	Gloss Black.	\$149.95

E. OIL DIPSTICK WITH TEMPERATURE GAUGE

Replace your Original Equipment oil dipstick with this custom-styled version featuring an easy-to-see mechanical temperature readout with Harley-Davidson logo. A chrome-plated cap completes the styling and provides an easy grip for removal.

63023-05	Fits '04-later XL and XR models.	\$59.95
62667-87TA	Fits '82-'03 XL models.	\$39.95

F. DIPSTICK BEZEL – GLOSS BLACK

This gloss black Dipstick Bezel replaces the Original Equipment chrome or satin silver bezel and completes the blacked-out look of the Sportster® model's right side oil tank cover. This bezel complements the available Gloss Black LCD Oil Level and Temperature Dipstick P/N 62700011. Includes replacement push nut for installation.

57200159		\$19.95
-----------------	--	----------------

Fits '04-later XL models.

G. CUT BACK SIDE COVERS

Instantly transform the profile of your Sportster motorcycle. These Cut Back Side Covers feature a unique two-piece design with a cutaway, technical look. The combination of gloss black and textured black surfaces visually reduces the size of the side covers, and the raised "speed lines" impart a sense of forward motion. The side covers feature improved mounting tabs for easy and secure installation. Right-side oil tank cover features a gloss black dipstick surround to add to the blacked-out look. Oil Tank Cover and Battery Cover are sold individually.

Fits '14-later XL models.

57200139	Oil Tank Cover.	\$149.95
57200140	Battery Cover.	\$149.95



G. OIL TANK COVER



G. BATTERY COVER

Notice: The prices appearing in this catalog are the manufacturer's suggested retail prices. Actual retail prices may vary.

102 SPORTSTER®

Chassis Trim

A. FUEL TANK TRIM PANEL KIT – CHROME

Set your fuel tank apart from the rest with this mirror chrome Fuel Tank Trim Panel. Fits around the stock fuel cap and is adhesive backed.

61653-04 \$124.95

Fits '04-later XL883C, XL1200C and XL1200L models. Also fits '04-later XL models equipped with a Sportster® Large Capacity Fuel Tank and Installation Kit P/N 62999-04 or 62999-07.



A. FUEL TANK TRIM PANEL KIT – CHROME

B. RIGHT SIDE OIL TANK COVER – CHROME

Like oil on blacktop, this Chrome Oil Tank Cover adds a brilliant sheen to the surface. Easy to install, the mirror chrome cover follows the contour of the frame and blends perfectly with the pop-up dipstick. A perfect complement for the Chrome Left Side Battery Cover P/N 66261-04.

66262-04 Fits '04-'13 XL models. \$114.95

C. LEFT SIDE BATTERY COVER – CHROME

Designed to hug the contour of the frame, this mirror chrome Battery Cover layers a splash of chrome to the left side of the bike. Easy to install, this cover is the ideal companion to the Chrome Oil Tank Cover P/N 66262-04.

66261-04 Fits '04-'13 XL models. \$114.95



B. RIGHT SIDE OIL TANK COVER – CHROME

D. BATTERY SIDE COVER – CHROME

This chrome-plated cover is designed for use with the Harley-Davidson® AGM sealed maintenance-free batteries and can be used in combination with Battery Top Cover P/N 66367-97 or 66368-97.

66718-01 \$49.95

Fits '97-'03 XL models and '97-'05 Dyna® models.



D. BATTERY SIDE COVER – CHROME

E. LOUD HORN KIT

Grab everyone's attention. Engineered to be 3dB louder (at 2 meters) than the Original Equipment front-mounted horn, this Horn Kit is tuned to a frequency wws cut through the background noise. Designed to be a plug-in replacement for the factory horn, this easy-to-install option is available in your choice of brilliant chrome or gloss black finish. The traditional Bar & Shield logo adds a classic finishing touch.

Fits '96-later XL and '08-'13 XR models with front-mount horn.

69000007 Chrome. \$29.95

69000009 Gloss Black. \$29.95



C. LEFT SIDE BATTERY COVER – CHROME

F. LOUD SIDE-MOUNT HORN KIT

Get Noticed. Ride with increased confidence with a loud horn that will grab everyone's attention. Engineered to be 5dB louder (at 2 meters) than the '13-earlier Original Equipment side-mounted horn. The loud horn is stock on '14-later models equipped with side-mount horns. Designed to be a plug-in replacement that is easy to install. Fits all H-D® side-mount horn covers.

69060-90H \$49.95

Fits '91-'17 VRSC™, '91-later XL1200C and XL1200V, '91-'17 Dyna (except '14-'17 FXDL), '91-'17 Softail® (except FLSTS, FLSTSC, FXCW, FXCWC, FXS, FXSB and FXSBSE), '91-later Touring and '09-later Trike models. Stock on '14-later models equipped with a side-mount horn.



E. LOUD HORN KIT – CHROME



E. LOUD HORN KIT – GLOSS BLACK

G. SIDE-MOUNT HORN KIT – CHROME

Convert your stock Sportster® horn to the look of a Big Twin.

69112-95E \$99.95

Fits '92-later XL883, XL883C, XL883H, XL883L, XL883N, XL883R, XL1200, XL1200L, XL1200N, XL1200NS, XL1200R, XL1200V, XL1200X and XL1200XS and '08-'13 XR models.



F. LOUD SIDE-MOUNT HORN KIT



G. SIDE-MOUNT HORN KIT – CHROME

Notice: The prices appearing in this catalog are the manufacturer's suggested retail prices. Actual retail prices may vary.

SPORTSTER® 103

Chassis Trim



NEW

H. DOMINION FUEL CAP – GLOSS BLACK



NEW

H. DOMINION FUEL CAP – BRONZE

H. DOMINION™ COLLECTION FUEL CAPS

Add a custom touch to your tank. Styled to reflect your attitude, these fuel caps are the perfect match for your ride. The fuel cap is easy to install and features a ratcheting design to ensure that the design faces the correct direction.

Fits '92-later XL, '92-'17 Dyna® (except '04-'17 FXD, FXDX, '05-'06 FXDC and '07 FXDSE), '00-later Softail® (except FXSTD, and '07-'08 FXSTSSE), '94-later Road King® and '15-later Freewheeler® models. Does not fit models equipped with Original Equipment locking or tethered fuel caps or Softail models with Low-Profile Chrome Fuel Tank Console P/N 71208-07. Use on '13-'14 FXSBSE requires removal of stock flush mount trim ring.

61100107	Gloss Black.	\$89.95
61100106	Bronze.	\$89.95

I. FLUSH-MOUNT FUEL CAPS

Emphasize the long and lean look of the fuel tank. This Flush-Mount Fuel Cap Kit offers a pop-up filler design that replaces the Original Equipment twist-on fuel cap. A simple push and the fuel filler cap pops up to provide ample grip, even while wearing gloves. Easy to install, the cap assembly screws into position and the self-adhesive decorative ring finishes the look. Complete kit includes screw-in mount, pop-up cap and matching trim ring.

Fits '98-later XL models equipped with 3.3 gal (12.5 L) fuel tank.

63133-10A	Chrome.	\$79.95
63134-10A	Gloss Black.	\$79.95

Fits '98-later XL models equipped with 2.1 gal (7.9 L) or 4.5 gal (17.0 L) fuel tank. Does not fit '04-'10 XL1200C models.

63139-10A	Chrome.	\$79.95
63140-10A	Gloss Black.	\$79.95

J. SIDE-MOUNT LICENSE PLATE KIT

Add a clean, custom look to the rear fender. This stylish kit moves the license plate from the fender to a side-mount location, visually lowering the bike's profile and opening up the view of the rear end. This strut-mounted hinged frame conceals the license mounting hardware and features a smooth back that hides the unfinished side of the plate. Kit includes LED license plate illumination and a curved Bar & Shield medallion, shaped to conceal the original license mounting holes in the fender. Purchase of tail lamp without license illumination window is recommended for models with center-mounted tail lights.

NOTE: License plate location and fold-away feature is regulated in many areas. Check local laws before installation.

Fits '04-later XL models (except XL1200T). Models with Original Equipment side mount license plate mount require additional purchase of Left Reflector Mount Bracket P/N 68857-07 and Reflector P/N 69490-07. Will not fit some International Specification '14-later XL883N models with Original Equipment LED Turn Signals. See your dealer for details. Will not fit models equipped with rigid mount saddlebags, rigid mount sissy bars and Turn Signal Relocation Kit P/N 68732-02A and 68733-02A.

60947-10	Chrome.	\$199.95
60972-10	Black.	\$199.95



I. FLUSH-MOUNT FUEL CAP – CHROME



I. FLUSH-MOUNT FUEL CAP – GLOSS BLACK



J. SIDE-MOUNT LICENSE PLATE KIT – CHROME



J. SIDE-MOUNT LICENSE PLATE KIT – BLACK

SPORTSTER

Notice: The prices appearing in this catalog are the manufacturer's suggested retail prices. Actual retail prices may vary.



STREET BOB®

DYNA® | FXDB | VIVID BLACK

It's everything you need to make a big, bold statement. The Vivid Black bodywork and the blacked-out powertrain are a blank canvas, while the minimalistic thin leather seat, paired with the brass controls and engine trim, add touches of contrast. It's how to hop from place to place in badass style.



Bobber Solo Saddle p117

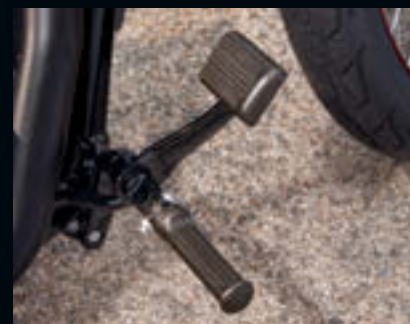

Brass Collection Footpeg and Brake Pedal p594



Street Slammer Handlebar — Satin Black..... p634



Brass Collection Air Cleaner Trim & Timer Cover ... p538

DEFY THE WIND

At highway speed, you take the wind full-force in the chest, causing fatigue in your arms, neck and shoulders.

Take the pressure off with an easy-to-install detachable windshield.

Shaped to divert air, rain and road debris around the rider, a windshield can add hours of riding comfort.

KEEPING YOU COVERED

20.1 IN

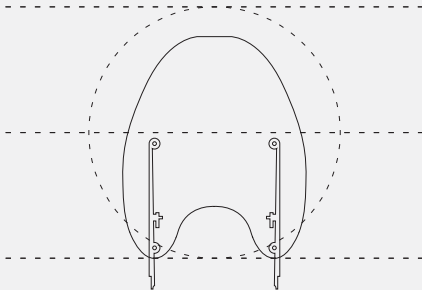

SUPER SPORT

Eliminates wind and debris, but keeps the wind-in-the-hair feeling. Ideal for a cool morning ride to the office, the sleek profile hugs the front lamps for a sporty look.

19.5 IN

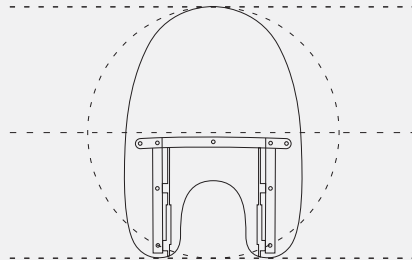

COMPACT

Traditional king-sized shape with a minimalist edge. For Harley-Davidson® custom and cruiser models, the Compact windshield provides wind and weather protection for every-day riding.

22.1 IN

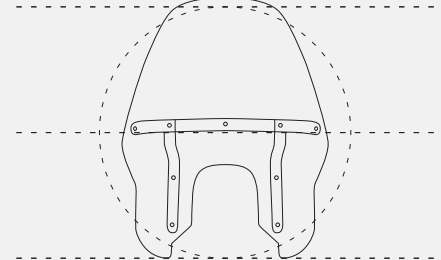

TOURING

Add maximum weather protection to your sporting motorcycle. Contoured to divert the wind around the rider's helmet and hands, a Touring windshield means long-ride comfort.

READY FOR TAKE-OFF

Designed to be installed or removed without tools in seconds, a detachable windshield gives you the freedom to define your ride at the drop of a hat. Ride across the country protected from the elements, then quickly remove the windshield to hit the streets in style.

SCRATCH-RESISTANT
HARD-COATED
POLYCARBONATE SHIELD

NO TOOLS
QUICK-RELEASE MOUNT

STAINLESS STEEL
BRACKETS & BRACES



To avoid looking through bug spots, condensation and road grime, select a windshield that tops out just below your line of sight.

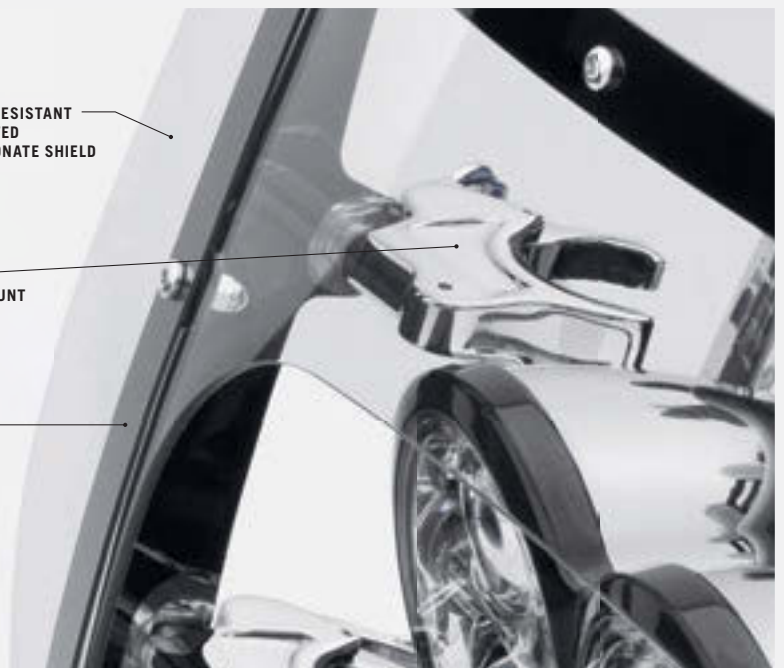

DYNA® 107

Windshields

A. QUICK-RELEASE SUPER SPORT WINDSHIELD

Reduces the pounding of wind and shower of bugs, but keeps the wind-in-the-hair feeling. Ideal for a cool morning ride, the sleek profile of the Super Sport Windshield hugs the front headlamp for a sporty look. The windshield mounts to the fork tubes with elegant die-cast lever locking clamps, so the windshield does not require any leave-behind docking hardware. You get quick on-and-off convenience and a clean, custom look. No tools are required and the kit includes everything needed to install the windshield.

57300-06 19" Light Smoke. **\$349.95**

Fits '06-'17 Dyna® (except FLD, FXDWG, FXDF and FXDSE) and '18-later Softail® FXBB and FXLR models. FXDLS models require the removal of Original Equipment Wind Deflector. Windshield dimensions: Overall height – 25.0"; width – 20.1".

57301-06 19" Light Smoke. **\$349.95**

Fits '06-'17 FXDWG, '13-'17 FXSB and FXSBSE and '18-later FXBR and FXBR models. Windshield dimensions: Overall height – 25.0"; width – 20.1".

57331-07 16" Light Smoke. **\$359.95**

Fits '07-'08 FXDSE and '00-'15 FXST, FXSTB and FXSTC models equipped with Custom Inverted Front Fork Kit P/N 46321-05, 46321-05A or 48646-06. Windshield dimensions: Overall height – 22.1"; width – 15.3".

57838-08 19" Light Smoke. **\$324.95**

Fits '88-later XL (except XL1200CX, XL1200T, XL1200X and '11-later XL883L and XL1200C) and '91-'05 Dyna models (except FXDWG and FXDXT). XL Custom models require Front Directional Relocation Kit P/N 68517-94A. Windshield dimensions: Overall height – 25.0"; width – 20.1".



A. QUICK-RELEASE SUPER SPORT WINDSHIELD (57300-06 SHOWN)



A. QUICK-RELEASE SUPER SPORT WINDSHIELD (57331-07 SHOWN)



A. QUICK-RELEASE SUPER SPORT WINDSHIELD (57838-08 SHOWN)

Notice: The prices appearing in this catalog are the manufacturer's suggested retail prices. Actual retail prices may vary.

108 DYNA®

Windshields

A. QUICK-RELEASE COMPACT WINDSHIELD

Combine the classic Harley-Davidson® windshield shape with a revolutionary new attachment system and you have the best of style and function. The windshield mounts to the fork tubes with elegant die-cast lever-release clamps, so the windshield does not require any leave-behind docking hardware. You get quick on-and-off convenience and a clean, custom look. No tools are required and the kit includes everything needed to install the windshield. The tough, hard-coated polycarbonate windshield is available in your choice of traditional polished or gloss black horizontal and vertical braces.

Fits '06-'17 Dyna® (except FLD, FXDF, FXDSE and FXDWG) and '18-later Softail® FXBB and FXLR models. FXDLS models require the removal of Original Equipment Wind Deflector.

58346-06 18" Clear – Polished Braces. **\$374.95**

Windshield dimensions: Overall height – 26.8"; width – 19.7".

58348-06 14" Light Smoke – Polished Braces. **\$379.95**

Windshield dimensions: Overall height – 22.8"; width – 19.5".

57609-08 18" Clear – Polished Braces. **\$389.95**

Fits '06-'17 Dyna® models (except FLD, FXDF, FXDSE, FXDWG, and '14-'17 FXDL and FXDLS) equipped with Auxiliary Lighting Kits. Windshield dimensions: Overall height – 26.8"; width – 19.7".

Fits '06-'17 FXDWG, '13-'17 FXSB and FXSBSE and '18-later FXBR and FXBRS models.

58387-06 18" Clear – Polished Braces. **\$369.95**

Windshield dimensions: Overall height – 26.8"; width – 19.5".

58444-06 14" Light Smoke – Polished Braces. **\$374.95**

Windshield dimensions: Overall height – 22.8"; width – 19.5".

Fits '08-'17 FXDF and FXDFSE models.

57338-08 19" Clear – Polished Braces. **\$379.95**

Windshield dimensions: Overall height – 27.0"; width – 19.6".

58617-09 19" Clear – Black Braces. **\$399.95**

Windshield dimensions: Overall height – 27.0"; width – 19.6".

58630-09 15" Light Smoke – Black Braces. **\$414.95**

Windshield dimensions: Overall height – 23.0"; width – 19.6".

Fits '88-later XL (except XL1200CX, XL1200T, XL1200X, XL1200XS and '11-later XL883L and XL1200C). XL1200NS requires removal of headlight visor. Also fits '91-'05 Dyna models (except FXDWG and FXDXT).

58063-04 18" Clear – Polished Braces. **\$369.95**

Windshield dimensions: Overall height – 26.8"; width – 19.7".

58706-09 18" Clear – Black Braces. **\$389.95**

Windshield dimensions: Overall height – 26.8"; width – 19.7".

58602-04 14" Light Smoke – Polished Braces. **\$374.95**

Windshield dimensions: Overall height – 22.8"; width – 19.5".

58703-09 14" Light Smoke – Black Braces. **\$394.95**

Windshield dimensions: Overall height – 22.8"; width – 19.5".

Fits '93-'05 FXDWG and '86-'15 FXST, FXSTB and FXSTC models.

59802-05 19" Clear – Polished Braces. **\$429.95**

Windshield dimensions: Overall height – 23.8"; width – 21.4".

57199-05 16" Light Smoke – Polished Braces. **\$439.95**

Windshield dimensions: Overall height – 20.8"; width – 21.4".

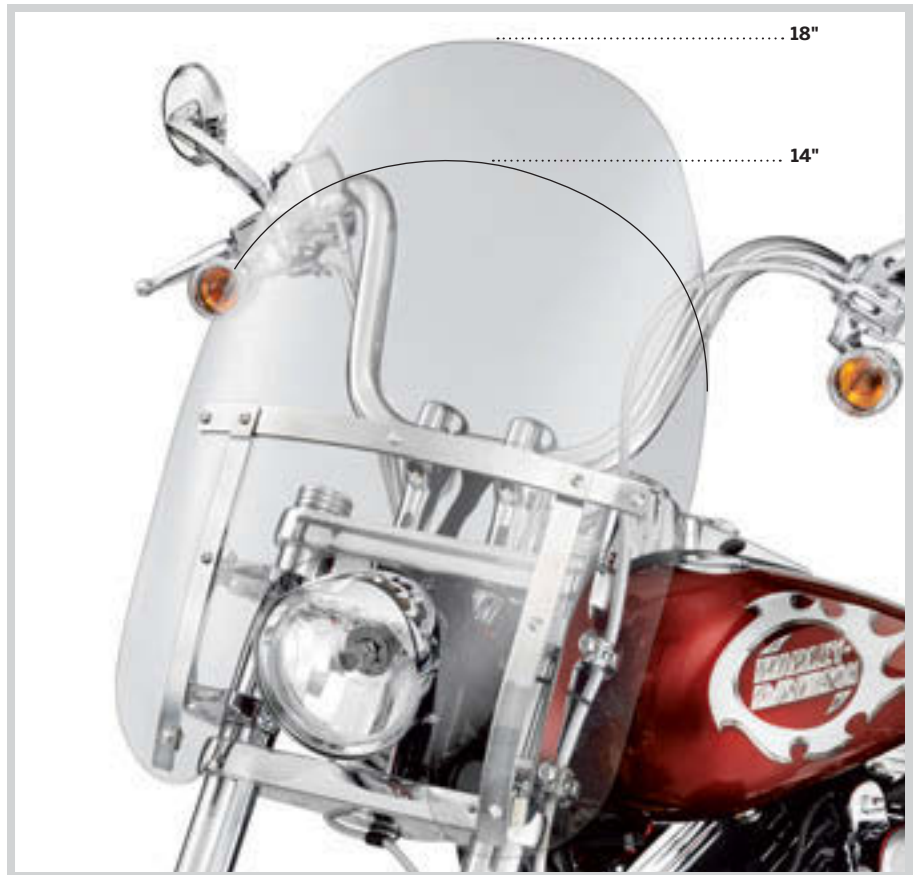

A. QUICK-RELEASE COMPACT WINDSHIELD – POLISHED BRACES



A. QUICK-RELEASE COMPACT WINDSHIELD – 15", GLOSS BLACK BRACES (SHOWN WITH TURN SIGNAL RELOCATION KIT)

Notice: The prices appearing in this catalog are the manufacturer's suggested retail prices. Actual retail prices may vary.

DYNA® 109

Windshields

B. H-D® DETACHABLES™ COMPACT WINDSHIELD FOR MODELS WITH AUXILIARY LIGHTING

Whether it's for keeping bugs off your face or warmth in your body, a windshield has a huge impact on rider and passenger comfort. By diverting air pressure past your chest and over your helmet, a windshield can add hours of riding comfort. This high-quality polycarbonate windshield mounts to the fork tubes with detachable Docking Hardware for easy on-and-off convenience and a quick return to a stripped-down profile and is shaped to fit models equipped with Auxiliary Lighting Kits.

57716-01 18" Clear. **\$289.95**

Fits '88-later XL (except XL1200CX, XL1200T, XL1200X, XL1200XS and '11-later XL883L and XL1200C), XL1200NS requires removal of headlight visor. Also fits '91-'05 Dyna® models (except FXDWG and FXDXT) equipped with Auxiliary Lighting Kits. Requires the separate purchase of Docking Hardware Kit P/N 58164-96A and Turn Signal Relocation Kit P/N 68603-01. Windshield dimensions: Overall height – 26.8"; width – 19.7".

58865-03 18" Clear. **\$299.95**

Fits '93-'05 FXDWG and '84-'15 FXST, FXSTC, FXSTB models equipped with Auxiliary Lighting Kits. Requires separate purchase of Docking Hardware Kit P/N 58361-03. Windshield dimensions: Overall height – 21.9"; width – 21.4".

Also available:

WINDSHIELD DOCKING HARDWARE AND TURN SIGNAL RELOCATION KIT

Required for installation of H-D® Detachables™ Windshields on FXDWG and FXST models equipped with Auxiliary Lighting Kits. Includes windshield mounting hardware and turn signal relocation hardware.

58361-03 **\$99.95**

Fits '93-'05 FXDWG and '84-'17 FXST, FXSTB and FXSTC models equipped with Auxiliary Lighting Kits.

Also available:

TURN SIGNAL RELOCATION KIT

This kit relocates the turn signals to the passing lamp bracket and allows the use of a detachable windshield. Kit includes all necessary hardware required for installation.

68603-01 **\$49.95**

Fits '88-later XL (except XL1200CX, XL1200T and XL1200XS and '16-later XL1200X), '91-'05 Dyna and '84-'15 FXS, FXST, FXSTB and FXSTC models equipped with Auxiliary Lighting Kits.

C. H-D® DETACHABLES™ TALL WINDSHIELD – SWITCHBACK™ MODEL

Get maximum protection from the wind. The detachable shield can be removed and reinstalled in seconds to tailor your bike to different riding conditions.

57400120 20" Clear. **\$349.95**

Fits '12-'16 FLD models. Windshield dimensions: Overall height – 27.0"; width – 24.0".



B. H-D DETACHABLES COMPACT WINDSHIELD FOR MODELS WITH AUXILIARY LIGHTING



C. H-D DETACHABLES TALL WINDSHIELD – SWITCHBACK

DYNA

Notice: The prices appearing in this catalog are the manufacturer's suggested retail prices. Actual retail prices may vary.

110 DYNA®

Windshields

A. QUICK-RELEASE TOURING WINDSHIELD

The Touring Windshield features an aerodynamic design shaped to provide hours of riding comfort. The additional center width directs airflow past the hand grips and deflects rain and road debris around the rider. The windshield mounts to the fork tubes with elegant die-cast lever-release clamps, so the windshield does not require any "leave-behind" docking hardware. You get quick on-and-off convenience and a clean, custom look. No tools are required and the kit includes everything needed to install the windshield. The tough, hard-coated polycarbonate windshield features traditional polished horizontal and vertical braces.

57015-06 19" Clear. **\$439.95**

Fits '06-'17 Dyna® models (except FLD, FXDF, FXDSE and FXDWG). FXDLS models require the removal of the stock wind deflector. Windshield dimensions: Overall height – 26.3"; width – 25.0".

58158-08 19" Clear. **\$439.95**

Fits '88-later XL (except XL1200CX, XL1200T, XL1200X and '11-later XL883L and XL1200C) and '91-'05 Dyna models (except FXDWG and FXDXT). Windshield dimensions: Overall height – 28.3"; width – 22.1".

B. H-D® DETACHABLES™ SUPER SPORT WINDSHIELD

Super is an apt description for this do-it-all windshield with detachable convenience and sport styling. The windshield mounts to the fork tubes with H-D® Detachables™ Docking Hardware (sold separately) for easy on-and-off convenience and a quick return to a sporting profile.

57965-97A 18" Light Smoke. **\$239.95**

Fits '93-'05 FXDWG, '80-'86 FXWG and '84-'15 FXST, FXSTB and FXSTC models. Use Docking Hardware Kit P/N 58350-96. Windshield dimensions: Overall height – 22.3"; width – 17.8".

Shown with:

DOCKING HARDWARE FOR H-D DETACHABLES WINDSHIELDS

58164-96A For 39mm Forks. **\$79.95**

Required for installation of H-D Detachables Windshields on '88-later XL (except XL1200CX, XL1200X and '11-later XL1200C) and '91-'05 Dyna models (except FXDWG and FXDXT). XL and Dyna models with Front Turn Signals originally located on the upper triple clamp may require the additional purchase of Turn Signal Wiring Kit P/N 72389-96.

58350-96 For 41mm Forks. **\$79.95**

Required for installation of H-D Detachables Windshields on '93-'05 FXDWG, '80-'86 FXWG and '84-'17 FXST, FXSTB and FXSTC models.

C. SPORT WINDSHIELD KIT

Formed of polycarbonate and hard-coated to resist scratching. Light smoke windshield is contoured to fit the headlamp and incorporates adjustable four-point mounting. Functional styling helps deflect wind to reduce upper body fatigue.

58192-87A 18" Light Smoke. **\$164.95**

Fits '88-later XL (except XL883C, XL1200C, XL1200CX, XL1200T, XL1200, XL1200XS and '11-later XL883L). XL1200NS requires removal of headlight visor. Also Fits '95-'05 Dyna models (except FXDWG and FXDXT). Includes black mounting hardware. Windshield dimensions: Overall height – 18.5"; width – 16.3".



A. QUICK-RELEASE TOURING WINDSHIELD – CLEAR



B. H-D DETACHABLES SUPER SPORT WINDSHIELD



C. SPORT WINDSHIELD KIT

Notice: The prices appearing in this catalog are the manufacturer's suggested retail prices. Actual retail prices may vary.



D. H-D DETACHABLES QUARTER FAIRING KIT – VIVID BLACK



E. HEADLAMP VISOR KIT – VIVID BLACK

D. H-D® DETACHABLES™ QUARTER FAIRING KIT*

Sleek, racy styling and sweeping lines define this innovative fairing. The quarter fairing-sized detachable design gives your bike a whole new sporty look that can be changed in an instant. Available in primed or Vivid Black finish, the fairing is interchangeable with H-D® Detachables™ Windshields, giving you plenty of options for cruising or touring. Plus, the windshield has a two-position adjustment feature for flexibility.

Fits '88-'16 XL (except XL883C, XL883N, XL1200C, XL1200CX, XL1200N, XL1200T, XL1200V, XL1200X and '11-later XL883L), FXR and '95-'05 Dyna® models (except FXLR, FXDWG and FXDXT). Requires the installation of Docking Hardware Kit P/N 58164-96A.

57070-98	Primed.	\$279.95
57070-97DH	Vivid Black.	\$399.95

E. HEADLAMP VISOR KITS*

Add an element of racy style to stock headlamps with these visors. Available in Primed or Vivid Black Harley-Davidson® paint.

Fits '95-later XL (except XL883C, XL1200C, XL1200CX, XL1200V, XL1200X and XL1200XS), '95-'05 Dyna (except FXDXT and FXDWG) and '82-'94 FXR and FXRS models. Does not fit with Clip-On Handlebar P/N 55800647.

68129-97	Primed.	\$139.95
68129-98DH	Vivid Black.	\$249.95

Fits '84-'99 FXST, FXSTC and '91-'05 FXDWG models.

68971-98B	Primed.	\$294.95
------------------	---------	-----------------

F. MID-FRAME AIR DEFLECTOR

Improve rider comfort during the summer riding season. Designed for severe duty and extreme temperature applications, these inconspicuous black deflectors attach to the frame and surround the top of the rear cylinder head. The scoop shape captures the moving air and uses the flow to direct the heat down and away from the rider to improve comfort. Kit includes all required mounting hardware.

29200011 **\$89.95**

Fits '06-'17 Dyna models. '06-'11 models require removal of Original Equipment coil cover and separate purchase of Coil Mounting Screws P/N 4717A (Qty 2). Does not fit with accessory Coil Covers P/N 31709-04 or 74616-04. Does not fit with Digital Oil Pressure Gauge P/N 75138-09 or 75340-09.

G. SOFT LOWERS

Extend your riding season. Full coverage Soft Lower provide wind and mud protection for the rider's legs and boots and minimize cold updrafts as the weather changes. Covers are custom shaped to hug the engine guard to minimize flapping and they simply clip in place for speedy installation as the weather changes. Two-way zippered outer edge accommodates guard-mounted highway pegs in almost any position. Reflective piping provides added visibility and convenient zippered pockets provide additional storage for maps or other small items.

57100212 **\$94.95**

Fits '06-'17 FXD, FXDB, FXDC and FXDL models equipped with Engine Guard P/N 49010-06 or 49320-09. Does not fit models with forward controls or footboards.

H. DYNA® FRONT SPOILER*

With a scooped shape designed to accent the long, lean Dyna® models, this sporty custom addition is injection-molded from high-impact materials. Available Primed or Vivid Black finishes. Includes all mounting hardware.

Fits '06-'17 Dyna models (except FLD). Will fit with Chrome Voltage Regulator Cover P/N 74667-06. Does not fit with engine guards. Does not fit California models equipped with evaporative emissions canister. Does not fit with Dyna Tool Roll P/N 91714-97A. Will not fit with Oil Cooler Kits.

58042-08BDK	Primed.	\$179.95
58042-08DH	Vivid Black.	\$244.95



F. MID-FRAME AIR DEFLECTOR (DYNA SWITCHBACK SHOWN)



G. SOFT LOWERS



H. DYNA FRONT SPOILER WITH POLISHED INSERT – VIVID BLACK

*NOTE: This product is a "Paint to Order" accessory. Please allow for an average of 5 weeks delivery for this item.

Notice: The prices appearing in this catalog are the manufacturer's suggested retail prices. Actual retail prices may vary.

ENJOY THE RIDE

The relationship between the seat, the handlebar and the foot controls has an enormous impact on the comfort, control, and confidence you feel when riding your motorcycle. Once you've picked the bike, it's time to choose the options that match your ride to your personal dimensions.



For shorter riders, consider tailoring your fit by changing to a Reach® Seat, Mid-Foot Controls, and lowered suspension height.



For taller riders, consider altering your ride by changing to a Tallboy® Seat and Extended Foot Controls.

ESTABLISH YOUR POSITION AND FEEL

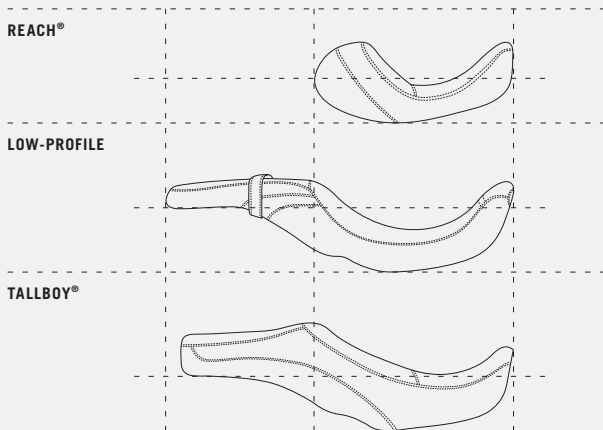

SEATS

Seat height and shape impact rider comfort, fit and confidence. Where the seat positions you relative to the foot controls, hand controls and the ground plays a major role in the quality of your ride.

SEE PAGES 113-117

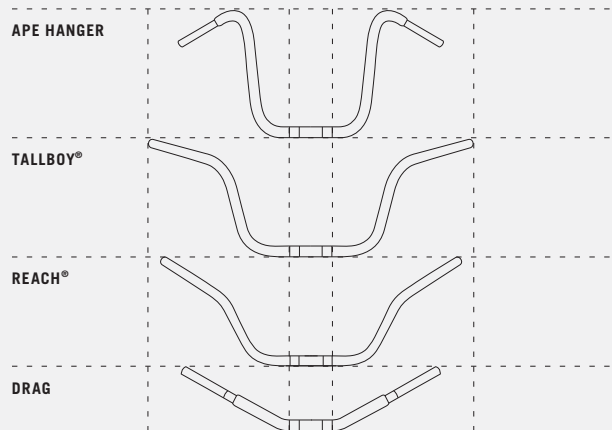

HANDLEBARS

Where the bar positions your arms, hands and wrists directly impacts how you feel on the motorcycle. Choose a bar that falls easily to hand, and does not pull you out of the seat when maneuvering.

SEE PAGES 632-635

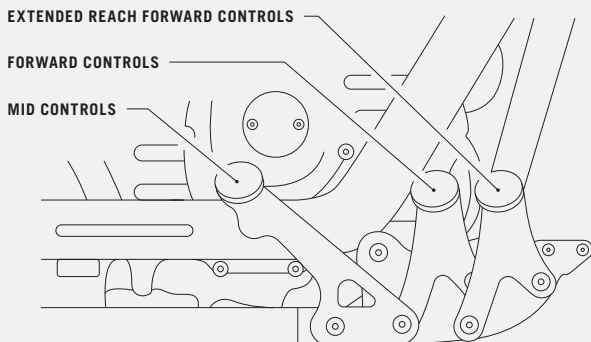

FOOT CONTROLS

Repositioning your feet can relieve muscle tension, take pressure off the tailbone and reduce fatigue. The correct riding position can add hours of comfort and hundreds of miles to your daily saddle time.

SEE PAGES 129-133, 580-613

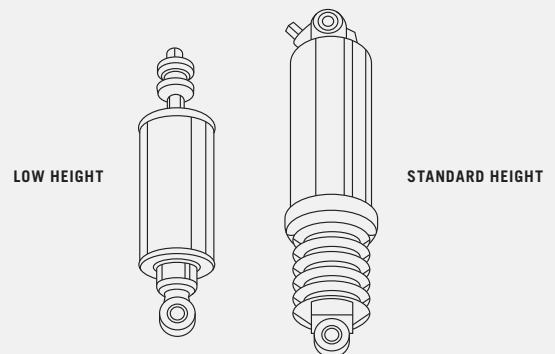

SUSPENSION

Adjusting your motorcycle's ride height by raising or lowering the suspension is often the first step in fitting the bike to your stature. Being sure-footed at a stop can really increase your sense of confidence.

SEE PAGE 128



A. SUPER REACH SOLO SEAT

A. SUPER REACH® SOLO SEAT

Get a little bit closer. Super Reach® forward position seats are designed to move riders with a shorter inseam even closer to the controls and to bring the legs about 1.0" closer together so that your feet rest firmly on the pavement. The scooped bucket-shaped saddle is enhanced with added back support padding to move the rider up to 1.0" lower and 3.0" forward. The combination positions the rider closer to the hand and foot controls to offer both comfort and confidence. For a two-up ride, combine the solo seat with the Touring Passenger Pillion P/N 51404-10 (sold separately).

54384-11 **\$249.95**
Fits '06-'17 Dyna® models. Seat width 10.5".

B. REACH SEAT

Designed specifically for riders requiring a close to the bar riding position, this seat positions the rider approximately 1.0" forward, closer to the hand and foot controls. The narrow front profile brings your legs closer together to help you plant your feet firmly on the ground. The seat features a textured vinyl insert and a Harley-Davidson logo that shows you are riding in style.

52288-06 **\$324.95**
Fits '06-'17 Dyna models. FXD, FXDB and FXDLS models require separate purchase of Seat Bumper Kit P/N 51653-06, Passenger Footpegs and Passenger Footpeg Mounting Kit P/N 50210-06. Seat width 12.0"; passenger pillion width 9.0".



B. REACH SEAT

C. TALLBOY® SEAT

Stretch your legs in style. The Tallboy® one-piece seat moves the rider back 1.75" and up 2.0" as compared to the Original Equipment seat. The new position allows additional leg and arm movement for the long-limbed rider and a comfortable seating space for the open road. The Tallboy Seat also features a wide pillion for added passenger comfort.

51471-06 **\$314.95**
Fits '06-'17 Dyna models. FXD, FXDB and FXDLS models require separate purchase of Seat Bumper Kit P/N 51653-06, Passenger Footpegs and Passenger Footpeg Mounting Kit P/N 50210-06. Seat width 16.0"; passenger pillion width 12.0".



C. TALLBOY SEAT

NOTE: Some Harley-Davidson® seats are made of leather. Fine leathers or other natural materials WILL gain "character," such as wrinkles or wear, with age. This is normal. A fine, aged patina and character wrinkles are a sign of the extremely high quality materials used to construct your seat or backrest. The appearance of scars or marks on the leather are a result of using natural leather panels and should not be thought of as an imperfection. Please use Harley-Davidson Leather Protectant P/N 93600034 to protect your investment.

Notice: The prices appearing in this catalog are the manufacturer's suggested retail prices. Actual retail prices may vary.

114 DYNA®

Seating – Comfort & Touring

A. SUNDOWNER™ SEAT

The Sundowner™ Seat provides the maximum in long-riding comfort. The deep-bucket design puts your body in the proper touring position and the generous padding makes it comfortable for both the rider and passenger as the miles are adding up. The dished shape provides added rider back support and the wide passenger pillion is shaped to minimize pressure points.

51540-06 **\$349.95**

Fits '06-'17 Dyna® models. FXD, FXDB and FXDLS models require separate purchase of Seat Bumper Kit P/N 51653-06, Passenger Footpegs and Passenger Footpeg Mounting Kit P/N 50210-06. Seat width 16.0"; passenger pillion width 12.0".

51540-04 **\$349.95**

Fits '04-'05 Dyna models. Seat width 16.0"; passenger pillion width 12.0".

51540-01A **\$349.95**

Fits '96-'03 Dyna models. FXDWG models require separate purchase of Bracket P/N 52152-97. Seat width 16.0"; passenger pillion width 12.0".



**A. SUNDOWNER SEAT
(SHOWN WITH SMOOTH BUCKET PASSENGER BACKREST PAD)**

B. SUNDOWNER SOLO SEAT

Ride solo on your Dyna motorcycle in Sundowner comfort and style. This unique seat combines the deep bucket design and added back support of the two-up seat with the stripped-down look of a solo saddle. Matching passenger pillion is available for added versatility.

51933-06 **\$249.95**

Fits '06-'17 Dyna models. Seat width 14.5".

C. SUNDOWNER PASSENGER PILLION

Bring someone along for the ride without giving up your solo status. This carefully styled pillion matches Dyna Sundowner Solo Seat and provides your passenger with that great Sundowner comfort.

51473-06A **\$169.95**

Fits '06-'17 Dyna models equipped with Sundowner Solo Seat P/N 51933-06 or '06-'08 FXDB and '06-'09 FXDWG models equipped with Original Equipment solo seat. FXD and FXDB models require separate purchase of Passenger Footpegs and Passenger Footpeg Mounting Kit P/N 50210-06. Pillion width 12.0".



B. SUNDOWNER SOLO SEAT



C. SUNDOWNER PASSENGER PILLION

D. SIGNATURE SERIES® SEAT WITH RIDER BACKREST

A perfect combination of foam density and shape has created our most comfortable seat for long-haul touring. Both rider and passenger will be extra comfy riding to Sturgis and back with the wide-seating area. When you reach your destination, city driving will be easier with the narrow nose that helps keep your legs closer together. Seat features an easily removable adjustable rider backrest that folds down for easier passenger mounting. Rider backrest has a 5-position height adjustment with 1.5" range and a wide range of forward/back angle adjustment with a quick twist of the control knob.

52000015 **\$559.95**

Fits '06-'17 Dyna models. FXD, FXDB and FXDLS models require separate purchase of Seat Bumper Kit P/N 51653-06, Passenger Footpegs and Passenger Footpeg Mounting Kit P/N 50210-06. Seat width 16.0"; passenger pillion width 12.0".



**D. SIGNATURE SERIES SEAT WITH RIDER BACKREST
(SHOWN WITH SMOOTH LOW PASSENGER BACKREST PAD)**

Notice: The prices appearing in this catalog are the manufacturer's suggested retail prices. Actual retail prices may vary.



E. BRAWLER SOLO SEAT

E. BRAWLER® SOLO SEAT

When it's time to go it alone, go in style. These premium quality cowhide leather solo saddles feature a smooth, sleek design that hugs the frame rails for a true custom look. The Brawler® seat's design places the rider "in" the bike for a low-slung riding position, and features a kick-up in the rear to hold the rider in place. The seating position is generally lower than stock, but not as far back as Badlander or other low profile seats. The top-grain leather seating surface and contoured foam padding provide a firm but luxurious feel. Seat does not fit with passenger pillions.

52000266

\$349.95

Fits '06-'17 Dyna® models. Seat width 12.5".

F. LEATHER BADLANDER® SEAT

The traditional Badlander® seat's low and lean style sets the stage for your minimalist custom ride. The frame-hugging rider seat and the slim tapered passenger pillion visually stretch the bike and enhance the slammed look. The seat shape stays low along its entire length and follows the lines of the bike with minimal disruption, and delivers a riding position that is lower and generally further back than the stock seat. Ideal for both short riders needing to be closer to the ground, or for tall riders that want to move back in the bike without sitting higher. This seat is wrapped in supple top-grain leather and finished with an embroidered Harley-Davidson script. Kit includes leather grab strap and mounting hardware.

52359-06

\$394.95

Fits '06-'17 Dyna models. FXD, FXDB and FXDLS models require separate purchase of Seat Bumper Kit P/N 51653-06, Passenger Footpegs and Passenger Footpeg Mounting Kit P/N 50210-06. Seat width 11.0"; passenger pillion width 5.0".

G. BADLANDER SEAT

Clean smooth covers, subtle top-stitching and a frame-hugging profile add up to a statement only Harley could create. The low design delivers a reduced seat height that is ideal for riders that want the shortest possible reach to the ground, and the long and lean shape allows tall riders to move back from the hand and foot controls without sitting higher on the bike. Kit includes grab strap and all mounting hardware.

52284-06

\$294.95

Fits '06-'17 Dyna models. FXD, FXDB and FXDLS models require separate purchase of Seat Bumper Kit P/N 51653-06, Passenger Footpegs and Passenger Footpeg Mounting Kit P/N 50210-06. Seat width 11.0"; passenger pillion width 5.0".

52284-04

\$294.95

Fits '04-'05 Dyna models. Seat width 11.0"; passenger pillion width 5.0".

52284-96A

\$294.95

Fits '96-'03 Dyna models. Seat width 11.0"; passenger pillion width 5.0".



F. LEATHER BADLANDER SEAT



G. BADLANDER SEAT

NOTE: Some Harley-Davidson® seats are made of leather. Fine leathers or other natural materials WILL gain "character;" such as wrinkles or wear, with age. This is normal. A fine, aged patina and character wrinkles are a sign of the extremely high quality materials used to construct your seat or backrest. The appearance of scars or marks on the leather are a result of using natural leather panels and should not be thought of as an imperfection. Please use Harley-Davidson Leather Protectant P/N 93600034 to protect your investment.

Notice: The prices appearing in this catalog are the manufacturer's suggested retail prices. Actual retail prices may vary.

116 DYNA®

Seating – Low-Profile & Pillion

A. LOW-PROFILE LEATHER SEAT

Prowl the town in style. Featured as Original Equipment on the '07 CVO™ Dyna® model, this low-profile seat features a breathable perforated leather insert. The firm padding makes you feel a part of the bike and the raised back stop keeps you in place when you hit the gas.

52378-07 **\$359.95**

Fits '06-'17 Dyna® models. FXD, FXDB and FXDLS models require separate purchase of Passenger Footpegs and Passenger Footpeg Mounting Kit P/N 50210-06. Seat width 12.0"; passenger pillion width 7.0".



A. LOW-PROFILE LEATHER SEAT

B. PASSENGER PILLION – SMOOTH STYLING

Bring a passenger along for the ride. This Passenger Pillion includes a passenger grab strap.

51404-10 Smooth. **\$159.95**

Fits '09-'17 FXDB and '10-'17 FXDWG models with Original Equipment solo seat. Installation on FXDB models requires separate purchase of Passenger Footpegs and Passenger Footpeg Mounting Kit P/N 50210-06.

51535-06A Smooth. **\$159.95**

Fits '06-'09 Dyna models (except '09 FXDB). FXD and FXDB models require separate purchase of Passenger Footpegs and Passenger Footpeg Mounting Kit P/N 50210-06. Pillion width 9.5".



B. PASSENGER PILLION – SMOOTH STYLING

C. QUICK-RELEASE PASSENGER PILLION

Styled to complement stock or accessory solo seats, this Passenger Pillion delivers maximum passenger comfort on the road. The pillion is easily removable from the Solo Rack P/N 52796-09 with a simple finger-pull release. The available Sissy Bar Upright P/N 52726-09 attaches directly to the pillion to provide a completely removable touring system.

52689-09 **\$219.95**

Fits '06-'17 Dyna models (except FXDF, FXDFSE, FXDLS and '10-'17 FXDWG) with solo seats. Installation requires separate purchase of Rigid Solo Rack P/N 52796-09. FXD, FXDB and FXDLS models require separate purchase of Passenger Footpegs and Passenger Footpeg Mounting Kit P/N 50210-06. Pillion width 11.0".

D. PASSENGER Sissy BAR UPRIGHT

Styled to blend with the muscular look of the Dyna family, this gloss black upright attaches directly to the passenger pillion for a clean look. Combine with Backrest Pad P/N 51782-07 for a complete touring system.

52726-09 Gloss Black. **\$59.95**

Fits '06-'17 Dyna models (except FLD, FXDF, FXDFSE, FXDLS and '10-'17 FXDWG) with solo seats. Installation requires separate purchase of Rigid Solo Rack P/N 52796-09 and Passenger Pillion P/N 52689-09.

Shown with:

COMPACT PASSENGER BACKREST PAD

Styled to complement Original Equipment and accessory seats, these Compact Backrest Pads are engineered to fit specific sissy bar uprights.

51782-07 Smooth. **\$79.95**

Fits '07-'11 VRSC™ (except VRSCF), '06-'07 VRSCR and '06 VRSCSE models equipped with Sissy Bar Upright P/N 51162-06 or 51313-07, '06-'17 Dyna models equipped with Sissy Bar Upright P/N 52726-09. FXDB HDI models require 67800499 Turn Signal Relocation Kit.



C. QUICK-RELEASE PASSENGER PILLION – REMOVED



D. PASSENGER Sissy BAR UPRIGHT (SHOWN WITH COMPACT BACKREST PAD)

Notice: The prices appearing in this catalog are the manufacturer's suggested retail prices. Actual retail prices may vary.



E. BOBBER SOLO SADDLE (SHOWN WITH SPRING SADDLE INSTALLATION KIT)

E. BOBBER SOLO SADDLE

How low can you go? This minimalist solo seat takes the stripped-down garage-built look about as far as you can go. The thick distressed black leather cover is bonded directly to the formed metal seat pan and minimizes the foam filler and the extra height it brings. The raw-edge leather pad is joined to the pan with brass rivets, and features matching brass "Milwaukee Since 1903" trim that will develop a rich patina with use. The Bar & Shield logo is embossed into the leather surface as a finishing touch. Easy to install, the bolt-on seat and a model-specific installation kit includes everything you need to get the bobber look. No cutting, welding or fabrication is necessary.

52000277 Distressed Black Leather. **\$299.95**
 Fits '04-'06 and '10-later XL, '06-'17 Dyna® and '08-'17 FLS, FLSS, FLSTC, FLSTN and FXS models. Installation requires separate purchase of model-specific Rigid or Spring Seat Mounting Hardware Kit. Seat width 10.5".

F. SOLO SADDLE

Add nostalgic bobber looks to your modern Harley-Davidson® motorcycle. Available in elegant leather, this solo seat features a low-profile design that provides the minimalistic "just enough to ride" look. The smooth metal seat pan and the simple frame cover leave a clean, finished appearance. Easy to install, the bolt-on seat and model-specific Spring Seat Installation Kit include everything you need to get the bobber look. No cutting, welding or fabrication is necessary and the seat can be removed and replaced with a touring seat for a two-up night on the town.

Fits '04-'06 and '10-later XL, '06-'17 Dyna and '08-'17 FLS, FLSS, FLSTC, FLSTN and FXS models. Installation requires separate purchase of model-specific Rigid or Spring Seat Mounting Hardware Kit. Seat width 10.5".

52000279 Black Leather. **\$299.95**
52000278 Brown Leather. **\$299.95**
52000276 Black Diamond. **\$299.95**

G. SPRING SADDLE INSTALLATION KIT

The torsion-style springs are designed for the optimum balance between spring suspension and support. Required for installation of Solo Saddle Kit P/N 52000277, 52000279, 52000278, 52000275, 52000276, 52000180, 54072-10, 54373-10, 52000114 and 52000113. Kit includes springs, mounting brackets, frame cover and hardware.

54075-10B **\$229.95**
 Fits '06-'17 Dyna models.



F. SOLO SADDLE – BLACK LEATHER (SHOWN WITH SPRING SADDLE INSTALLATION KIT)



F. SOLO SADDLE – BROWN LEATHER (SHOWN WITH SPRING SADDLE INSTALLATION KIT)



F. SOLO SADDLE – BLACK DIAMOND (SHOWN WITH SPRING SADDLE INSTALLATION KIT)



G. SPRING SADDLE INSTALLATION KIT

NOTE: Some Harley-Davidson® seats are made of leather. Fine leathers or other natural materials WILL gain "character," such as wrinkles or wear, with age. This is normal. A fine, aged patina and character wrinkles are a sign of the extremely high quality materials used to construct your seat or backrest. The appearance of scars or marks on the leather are a result of using natural leather panels and should not be thought of as an imperfection. Please use Harley-Davidson Leather Protectant P/N 93600034 to protect your investment.

Notice: The prices appearing in this catalog are the manufacturer's suggested retail prices. Actual retail prices may vary.



118 DYNA®

Seating Accessories

A. ROAD ZEPPELIN® SEAT PAD

Experience ultimate comfort. Designed to ensure hours of comfort in the saddle, Road Zeppelin® Seat Pads are equipped with a unique air bladder system that allows your weight to be supported evenly across the entire seating surface. Shaped to conform to most Harley-Davidson® seats, the pads feature adjustable mounting straps and a non-skid surface to keep them in place. The hand-washable seat pad can be deflated and rolled for compact storage.

52000327 Rider. **\$169.95**

Fits rider position on all models equipped with Original Equipment or accessory seats. Also fits passenger position on Touring models with large pillion area. Pad width – 14.0".

52400162 Passenger. **\$149.95**

Fits Original Equipment and accessory passenger pillions. Pad length – 12.0"; width – 9.0".



A. ROAD ZEPPELIN SEAT PAD



B. CIRCULATOR SEAT PADS

B. CIRCULATOR SEAT PADS

Designed to keep the rider cool by reducing the perspiration build-up between you and the seating surface, the Circulator Pad can be installed and removed in seconds for easy cleaning. The low-profile design minimizes seat-height change compared to inflatable pads, while enhancing comfort with its shock-absorbing construction. Elastic under-seat strap and non-slip base provide secure installation and the available Circulator Passenger Pillion Pad attaches to the rider pad with hook-and-loop tabs.

51074-10 Medium Seat Pad. **\$84.95**

Fits VRSC™, XG, XL and Dyna® models with Original Equipment and accessory seats. Pad width – 14.5"

51078-10 Passenger Pillion Pad. **\$69.95**

Fits Original Equipment and accessory passenger pillions. Pad width – 13.0"

52300103 Wide Backrest Pad. **\$59.95**

Fits wide profile rider and passenger backrest pads up to 12.0" wide and 9.0" tall.



C. RAIN COVER – SOLO SEAT



C. RAIN COVER – TWO-UP

C. RAIN COVERS*

Featuring a handy storage sack, this black nylon, water-resistant, Cordura® cover packs easily and shelters your seat from the storm.

51638-97 Solo Seat. **\$29.95**

Fits H-D® solo seats (except XR and FLSTS).

51639-97 Two-Up. **\$31.95**

Fits VRSC, XG, XL, Dyna and Softail® models with Two-Up seats. Does not fit Touring and Trike models. Does not fit with Rider Backrests.

D. QUICK-RELEASE SEAT HARDWARE KITS

This Quick-Release Hardware Kit allows the rider to remove one-piece Harley-Davidson® seats quickly and easily.

Fits '97-later XG, XL, Dyna®, Softail® (except '12-'17 FLS models equipped with Original Equipment seat), Touring and Trike models equipped with SAE 1/4"-20 seat mount hardware. Does not fit seats equipped with spring-loaded rear seat bracket.

51676-97A Chrome. **\$19.95**

10500093 Gloss Black. **\$19.95**



D. QUICK-RELEASE SEAT HARDWARE KIT – CHROME



D. QUICK-RELEASE SEAT HARDWARE KIT – GLOSS BLACK

E. REAR FENDER BIB

Wrapped in smooth vinyl to match Original Equipment or accessory solo seats, the Fender Bib features an embossed Bar & Shield logo for added style. The molded base is finished with a soft felt under-liner designed to protect the fender's painted surface.

52036-08 **\$59.95**

Fits '06-'17 Dyna models equipped with Original Equipment solo seat, Brawler® Solo Seat or Sundowner™ Solo Seat. Will not fit with Original Equipment seat on FXDLS. FXWDG models require removal of Original Equipment passenger pillion.



E. REAR FENDER BIB

F. TANK KNEE PAD KIT

The rich black rubber pads feature tapered ribs and a raised Bar & Shield logo to protect the surfaces where your legs contact the tank.

57300065 **\$39.95**

Fits fuel tanks on many Street™, Sportster®, Dyna and Softail models. May cover a portion of fuel tank graphics, check appearance before adhering to tank.



F. TANK KNEE PAD KIT



***WARNING:** Do not use while riding; could result in death or serious injury.

Notice: The prices appearing in this catalog are the manufacturer's suggested retail prices. Actual retail prices may vary.

BUILDING A BACKREST

A sissy bar upright and passenger backrest are the starting point to build a complete touring machine. The backrest provides long-range comfort and support and adds a feeling of control and confidence for the passenger. Start by selecting model-specific Docking Hardware, then choose a finish that matches your styling direction, determine the desired sissy bar height, and finally select a backrest pad that complements your seat.

DOCKING HARDWARE

PAGE 119



SHORT & TALL UPRIGHT

PAGE 120



SIDE PLATES

PAGE 120



PASSENGER BACKREST PAD

PAGE 122



SELECT THE DOCKING HARDWARE

Dyna® Docking Hardware for H-D® Detachables™ Racks and Sideplates

Docking hardware fitment is dependent on vehicle model and saddlebag configuration.

H-D Detachables Accessory

No Saddlebags: Detachable Sideplates 52124-09A (Gloss Black), 53543-95B (Chrome), 53834-00A (Wrinkle Black), 52866-06A (Chrome), 53870-01B (Chrome), Detachable Solo Rack 53511-06A, One-Piece Detachable Uprights 51161-10A (Gloss Black), 52300042 (Chrome), One-Piece Detachable Uprights 52300044A (Chrome), 52300046A (Gloss Black)

With P&A Saddlebags: Adjustable Sideplates 52300110 (Chrome), 52300090 (Gloss Black), Detachable Sideplates 52124-09A (Gloss Black), 53543-95B (Chrome), 53834-00A (Wrinkle Black), 52866-06A (Chrome), Detachable Solo Rack 53511-06A, One-Piece Detachable Uprights 51161-10A (Gloss Black), 52300042 (Chrome), One-Piece Detachable Uprights 52300044 (Chrome), 52300046A (Gloss Black)

With P&A Saddlebags: 79300-06D, 88200-09A, 88348-10, 90181-08A, 90307-98, 90369-02, 90369-06D, 90564-02, 90564-06D, 91617-03, 91615-09A, 90126-YYXXX

With Original Equipment Saddlebags: Detachable Sideplates 52300070A

Available to fit:

2006-2008 FXDWG & 2008-2009 FXDF and '09-'10 FXDFSE

2006-later FXD, FXDC, FXDL and FXDSE, 2006-2008 FXDB

2009-later FXDB (except 2013-later HDI and India configuration)

2010-later FXDWG

2010-later FXDF

2006-2008 FXDWG & 2008-2009 FXDF and FXDFSE/2

2006-later FXD, FXDC, FXDL and FXDSE, 2006-2008 FXDB

2009-later FXDB

2010-later FXDWG

2010-later FXDF

2012-2016 FLD

	Required Docking Hardware		Directional Relocation Kit	
2006-2008 FXDWG & 2008-2009 FXDF and '09-'10 FXDFSE	53964-06B	\$44.95	—	—
2006-later FXD, FXDC, FXDL and FXDSE, 2006-2008 FXDB	53961-06	\$49.95	53968-06C	\$49.95
2009-later FXDB (except 2013-later HDI and India configuration)	53797-09	\$69.95	53968-06C	\$49.95
2010-later FXDWG	54097-10	\$49.95	53968-06C	\$49.95
2010-later FXDF	53964-06B	\$44.95	—	—
2006-2008 FXDWG & 2008-2009 FXDF and FXDFSE/2	53964-06B	\$44.95	—	—
2006-later FXD, FXDC, FXDL and FXDSE, 2006-2008 FXDB	53961-06	\$49.95	—	—
2009-later FXDB	53797-09	\$69.95	68227-09	\$109.95
2010-later FXDWG	54097-10	\$49.95	53968-06C	\$49.95
2010-later FXDF	53964-06B	\$44.95	—	—
2012-2016 FLD	52300065	\$109.95	—	—

Notice: The prices appearing in this catalog are the manufacturer's suggested retail prices. Actual pricing may vary.

120 DYNA®

Bacrests & Racks

A. H-D® DETACHABLES™ SIDEPLATES

In the time it takes for a traffic light to change, you can transform your motorcycle from a city cruiser to a cross country hauler. Start with Harley-Davidson® Detachables™ Sideplates, and add your choice of sissy bar upright and pad to make removing the passenger backrest a simple slide and click operation. Manufactured and tested to rigorous Harley-Davidson standards, installation requires separate purchase of model-specific Docking Hardware Kit.

1. Fits '06-'17 Dyna® models (except FLD). Requires separate purchase of appropriate Docking Hardware kit. '13-'17 FXDB models equipped with a side-mount license plate require License Plate Relocation Kit P/N 67900130. '13-'17 FXDB HDI/India configuration require separate purchase of Docking Hardware and Turn Signal Relocation Kit P/N 67800499. Not for use with LED Rear Turn Signal Kit P/N 67800055A or 67800056A.

52866-06A Chrome. **\$149.95**
52124-09A Gloss Black. **\$149.95**

2. Fits '12-'16 FLD models. Requires separate purchase of Docking Hardware Kit P/N 52300065.

52300070A Chrome. **\$149.95**

3. Fits '96-'05 Dyna models (except FXDWG and FXDXT). '96-'01 models using these sideplates in combination with Luggage Racks P/N 53711-96A, 53852-00 or 53866-00 require separate purchase of Luggage Rack Adapter Kit P/N 53828-00.

53543-95B Chrome. **\$149.95**

SISSY BAR UPRIGHTS

Sissy Bar Uprights are available in a variety of shapes and styles. Round bar uprights feature a mini medallion bar and an embossed Bar & Shield insert. Uprights are designed to accept specific 3-bolt or 2-bolt mounted backrest pads.

B. LOW SISSY BAR UPRIGHT

Shaped to complement a thicker passenger pillion, this Low Sissy Bar Upright stands between the Standard and the Short Bar Upright. The ideal match for touring style seats, this upright also offers additional height options to riders with custom style seats.

Fits '04-later XL models with H-D Detachables sideplates, '06-'17 Dyna (except FXDF, FXDFSE and '10-'17 FXDWG), '84-'05 Softail® (except FXSTD) and '06-later FL Softail models (except '07-'17 FLS, FLSS, FLSTF, FLSTFB, FLSTFBS, FLSTSE and FLSTSB and '06 FLSTFSE) with appropriate sideplates.

52300022 Chrome. **\$99.95**
52300024 Gloss Black. **\$99.95**

Fits '10-'17 FXDF and FXDWG and '10 FXDFSE models with appropriate sideplates.

52300049 Chrome. **\$99.95**
52300050 Gloss Black. **\$99.95**

C. STANDARD SISSY BAR UPRIGHT

Give your passenger additional back support with a Standard Sissy Bar Upright designed to accept a wide variety of backrest pads.

Fits '04-later XL models with H-D Detachables sideplates, '06-'17 Dyna (except FXDF, FXDFSE and '10-'17 FXDWG), '84-'05 Softail (except FXSTD) and '06-later FL Softail models (except '07-'17 FLS, FLSS, FLSTF, FLSTFB, FLSTFBS, FLSTSE and FLSTSB and '06 FLSTFSE) with appropriate sideplates.

52300018 Chrome. **\$99.95**
52300020 Gloss Black. **\$99.95**

Fits '10-'17 FXDF and FXDWG and '10 FXDFSE models with appropriate sideplates.

52877-10 Chrome. **\$99.95**
51168-10 Gloss Black. **\$99.95**



A. H-D DETACHABLES SIDEPLATES



B. LOW SISSY BAR UPRIGHT – CHROME
(52300022 SHOWN)



B. LOW SISSY BAR UPRIGHT – GLOSS BLACK
(52300024 SHOWN)



C. STANDARD SISSY BAR UPRIGHT – CHROME
(52300018 SHOWN)



C. STANDARD SISSY BAR UPRIGHT – GLOSS BLACK
(52300020 SHOWN)



C. STANDARD SISSY BAR UPRIGHT – CHROME
(52877-10 SHOWN)



C. STANDARD SISSY BAR UPRIGHT – GLOSS BLACK
(51168-10 SHOWN)

Notice: The prices appearing in this catalog are the manufacturer's suggested retail prices. Actual retail prices may vary.



D. ONE-PIECE H-D DETACHABLES SISSY BAR UPRIGHT – CHROME



D. ONE-PIECE H-D DETACHABLES SISSY BAR UPRIGHT – GLOSS BLACK



E. LOCKING H-D DETACHABLES LATCH KIT – CHROME



E. LOCKING H-D DETACHABLES LATCH KIT – BLACK



F. H-D DETACHABLES LATCH KIT – CHROME



G. REAR DOCKING HARDWARE COVER KIT – CHROME



G. REAR DOCKING HARDWARE COVER KIT – GLOSS BLACK

D. ONE-PIECE H-D® DETACHABLES™ SISSY BAR UPRIGHT

The sweeping shape of this slim, round bar Sissy Bar Upright completes the classic bobber look. The one-piece design eliminates separate sideplates for a clean appearance and the stylized upper kick angle mimics the old-school sissy bars of the '50s and '60s. Available in chrome and gloss black finishes, these bars can be equipped with Passenger Backrest Pad P/N 52631-07.

Fits '06-'17 Dyna® models (except FLD, FXDF, FXDFSE and '10-'17 FXDWG). Requires separate purchase of appropriate Docking Hardware Kit. '13-'17 FXDB models equipped with a side-mount license plate require License Plate Relocation Kit P/N 67900130. '13-'17 FXDB HDL/India configuration require separate purchase of Docking Hardware and Turn Signal Relocation Kit P/N 67800499. Not for use with LED Rear Turn Signal Kit P/N 67800055A or 67800056A.

52300044A	Chrome.	\$209.95
52300046A	Gloss Black.	\$209.95

Fits '10-'17 FXDF and FXDWG models. Installation requires separate purchase of appropriate Docking Hardware Kit. Dyna Wide Glide® models require separate purchase of Docking Hardware Kit P/N 54097-10 and Turn Signal Relocation Kit P/N 53968-06C.

52300042A	Chrome.	\$209.95
51161-10A	Gloss Black.	\$209.95

Shown with:

PASSENGER BACKREST PAD

Styled to complement available touring and custom seats.

52631-07	\$74.95
-----------------	----------------

Fits One-Piece H-D® Detachables™ Sissy Bar Upright P/N 52729-08, 51853-07, 51849-07, 51146-10A, 51161-10A, 52300040A, 52300042A, 52300044A or 52300046A.

E. LOCKING H-D® DETACHABLES™ LATCH KIT

This unique lock replaces the camlock on your Harley-Davidson® Detachables™ accessories, providing additional security and peace of mind when parking your vehicle. The kit includes two extended-reach barrel-style keys for easy access to the lock. Key registration and replacement service is available. Sold in pairs.

Fits all models equipped with detachable Sideplates, Racks and Tour-Pak® Luggage Carriers (except '18-later Softail® models with HoldFast™ racks and uprights or '09-later Touring models equipped with detachable Solo Tour-Pak Rack).

90300087	Chrome.	\$79.95
90300086	Black.	\$74.95

F. H-D DETACHABLES LATCH KIT – CHROME

Decorative chrome latches are the perfect way to enhance the appearance of your detachable accessories. Meticulously polished and chrome-plated, these easy-to-install Rotary Latches are a direct replacement for the Original Equipment satin black parts and are a simple way to add a finishing touch to your ride. Latches feature an easy-to-pull finger release to simplify access in hard-to-reach areas.

12600036	\$49.95
-----------------	----------------

Fits all models equipped with detachable Sideplates, One-Piece Sissy Bar Uprights, Racks, and Tour-Pak Luggage Mounting Racks. (except '18-later Softail models with HoldFast racks and uprights).

G. REAR DOCKING HARDWARE COVER KIT

Disguise the rear docking hardware with these easy-to-install covers. The caps slide over the exposed docking points and are held in place by a strong magnetic pull. The caps are easy to remove when you wish to reinstall detachable accessories. Covers are available with brilliant chrome or durable gloss black finish to match your bike's attitude. Sold in pairs.

Fits many accessory docking hardware kits. Refer to the fitment matrix in this P&A Catalog page 571 or the Parts & Accessories section of www.harley-davidson.com for details.

48218-10	Short Chrome (pair).	\$34.95
48220-10	Large Chrome (pair).	\$34.95
48035-09	Small Chrome (pair).	\$34.95
48221-10	Short Black (pair).	\$34.95
48223-10	Large Black (pair).	\$34.95
48225-10	Small Black (pair).	\$34.95

Notice: The prices appearing in this catalog are the manufacturer's suggested retail prices. Actual retail prices may vary.

122 DYNA®

Backrests & Racks

PASSENGER BACKREST PADS

Choose from a wide variety of backrest pad sizes and shapes to match your comfort and style demands. Designed to complement Original Equipment and accessory seats, these pads are engineered to fit specific sissy bar upright types.

A. SLIP-OVER PASSENGER BACKREST PAD

This Slip-Over Backrest Pad provides a touch of passenger comfort, while maintaining the long, lean style of the Dyna® Wide Glide® model. Held in place with hook-and-loop tabs, this rich black pad features grey stitching that complements the Original Equipment seat and pillow.

51732-10 **\$69.95**

Fits '07-later XL models with Low-Profile Sissy Bar Upright P/N 52300403 and '10-'17 FXDWG models with Original Equipment sissy bar upright.

B. BACKREST PADS

Sized to fit medallion and mini medallion-style sissy bar uprights. Pad mounts with single center screw and bolt-on mounting strap. Includes chrome-plated mounting hardware.

Fits Low Medallion Style Sissy Bar Upright P/N 52754-04 or 51851-09, Low Square Bar Mini-Medallion Style Sissy Bar Upright P/N 53282-06, Standard Square Bar Mini Medallion Style Sissy Bar Upright P/N 53281-06 or 53407-06, Standard Medallion Style Sissy Bar Upright P/N 52735-85, 53007-98, 52655-84, 52909-02 or 51517-02, Standard Bar & Shield Style Sissy Bar Upright 52739-83 or 51514-02, Standard Heritage Style Sissy Bar Upright P/N 52731-00 and Low Round Bar Sissy Bar Upright P/N 52300022 or 52300024.

1. 52652-04 Smooth. **\$74.95**

2. 52626-04 Smooth Top-Stitched. **\$74.95**

C. BACKREST PADS

Sized to fit medallion and mini medallion-style sissy bar uprights. Pad mounts with single center screw and bolt-on mounting strap. Kit includes chrome-plated mounting hardware.

Fits Low Medallion Style Sissy Bar Upright P/N 52655-84, 52909-02, 52754-04, 51851-09, Standard Medallion Style Sissy Bar Upright P/N 52735-85 or 52877-08, Standard Square Bar Mini Medallion Style Sissy Bar Upright P/N 53281-06 or 53407-06, Standard Heritage Style Sissy Bar Upright P/N 52731-00 and Standard Round Bar Sissy Bar Upright P/N 52300018 or 52300020.

1. 52612-95 Smooth Top-Stitched. **\$74.95**

2. 52412-79A Embossed Bar & Shield Logo. **\$79.95**

3. 52348-97 Heritage Classic Bucket. **\$109.95**

4. 52347-97 Fat Boy® Bucket. **\$109.95**

5. 51132-98 Smooth Bucket. **\$99.95**

D. BACKREST PADS

Sized to fit round bar sissy bar uprights, these pads mount to mini medallion style uprights with two mounting holes.

Fits Standard Round Bar Mini-Medallion Style Upright P/N 52877-10 or 51168-10. Also fits Low Round Bar Mini Medallion Style Sissy Bar Upright P/N 52300401, 52540-09A, 51477-06, 54256-10, 52300049 and 52300050.

1. 51641-06 Smooth Top-Stitched. **\$74.95**

2. 51640-06 Smooth Bucket. **\$99.95**

3. 51622-07 Fat Boy Lacing Bucket. **\$119.95**



A. SLIP-OVER PASSENGER BACKREST PAD



B. BACKREST PADS



C. BACKREST PADS



D. BACKREST PADS

Notice: The prices appearing in this catalog are the manufacturer's suggested retail prices. Actual retail prices may vary.

DYNA® 123

Backrests & Racks



E. AIR FOIL PREMIUM LUGGAGE RACK – CHROME



E. AIR FOIL PREMIUM LUGGAGE RACK – GLOSS BLACK

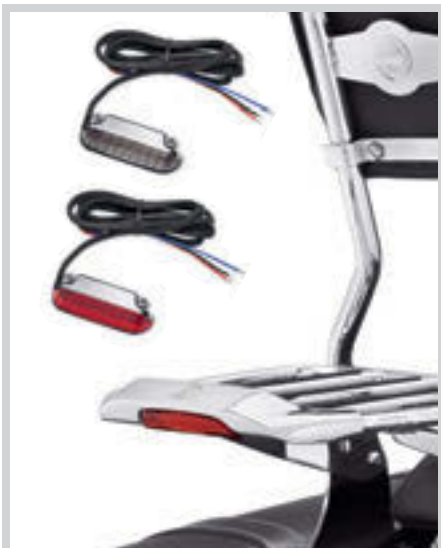

F. LED LIGHT KIT – RED LENS



G. FIVE BAR SPORT LUGGAGE RACK – CHROME

E. AIR FOIL PREMIUM LUGGAGE RACK*

The low-profile aerodynamic styling defines the look of this Luggage Rack. Available in mirror chrome or rich gloss black finish, the die-cast rear "Air Foil" grabs your attention and the Bar & Shield insert adds a signature touch. The elegant round tube rack features inlaid rubber runners for added grip and dedicated bungee mounting points to simplify luggage tie-down. Kit includes all necessary mounting hardware. For added visibility, the rack is designed to incorporate the internal wiring of the Air Foil Rack LED Light Kit P/N 68000076 (red) or 68000077 (smoked) for a clean look.

Fits '04-later XL models equipped with H-D® Detachables™ Sideplates, '06-'17 Dyna® models (except FXDF, FXDFSE and '10-'17 FXDWG) equipped with Detachable Sideplates, '84-'05 Softail® (except FLSTN and FXSTD) and '06-'17 FLST, FLSTC, FLSTNSE and FLSTSC and '06 FLSTF models equipped with Detachable Sideplates.

54290-11	Chrome.	\$214.95
54291-11	Gloss Black.	\$214.95

F. LED LIGHT KIT**

This fast-acting LED Light Kit operates as a supplemental rear running light and brake light. The high, center-mount position places the light in the line-of-sight of following vehicles and the bright, fast-acting LED lamps get you noticed. Wiring is concealed inside the rack tubes for a clean, custom installation. Available with red or smoked lens.

Fits Air Foil Luggage Rack P/N 54290-11, 54291-11 and Air Wing Sissy Bar Upright P/N 52300146 and 52300147. Installation requires separate purchase of model-specific Wiring Harness Kit.

68000076	Red Lens.	\$49.95
68000077	Smoked Lens.	\$49.95

Also available:

LED LIGHT KIT WIRING HARNESS

Required for installation of LED Light Kit on Air Foil Luggage Rack P/N 54290-11 or 54291-11.

73415-11	\$11.95
-----------------	----------------

Fits '06-'17 Dyna (except FXDF, FXDFSE, '14-'17 FXDL, '16-'17 FXDLS and '10-'17 FXDWG), '84-'05 Softail® (except FXSTD and FLSTN), '06-'17 FLST, FLSTC and FLSTSC and '06 FLSTF models with Air Foil Luggage LED Light Kit P/N 68000076 or 68000077.

G. FIVE BAR SPORT LUGGAGE RACK – CHROME*

This rack brings touring flexibility to your motorcycle. Can be used with H-D Detachables or Rigid Mount Sissy Bar Sideplates.

53862-00	\$149.95
-----------------	-----------------

Fits '04-later XL models (except XL1200CX) equipped with Detachable Sideplates, '06-'17 Dyna models (except FXDF, FXDFSE and '10-'17 FXDWG) equipped with Detachable Sideplates, '84-'05 Softail (except FLSTN and FXSTD), '06-'17 FLST, FLSTC and FLSTSC and '06 FLSTF models equipped with Detachable Sideplates. Does not fit with Round Bar Uprights P/N 52300018, 52300020, 52300022 and 52300024.

***WARNING:** Do not use this rack as a seat. Do not exceed the fender rack weight capacity. Using as seat or exceeding this capacity could cause handling problems which could result in loss of control and death or serious injury.

****WARNING:** Disconnecting your DOT required tail, brake and turn signal lighting could reduce your visibility to others and result in death or serious injury.

Notice: The prices appearing in this catalog are the manufacturer's suggested retail prices. Actual retail prices may vary.

DYNA

124 DYNA®

Backrests & Racks

A. CUSTOM TAPERED SPORT LUGGAGE RACK*

Smooth sweeping curves and the brilliant chrome or gloss black finish define the look of this Sport Luggage Rack. Designed to complement both round and square bar Sissy Bar Uprights, this sleek rack adds a practical and stylish touch to the motorcycle.

Fits '04-later XL models (except XL1200CX) equipped with H-D® Detachables™ Sideplates, '06-'17 Dyna® models (except FXDF, FXDFSE and '10-'17 FXDWG) equipped with Detachable Sideplates, '84-'05 Softail® (except FLSTN and FXSTD) and '06-'17 FLST, FLSTC, FLSTNSE and FLSTSC and '06 FLSTF models equipped with Detachable Sideplates.

50300030	Chrome.	\$149.95
50300031	Gloss Black.	\$149.95

Fits '10-'17 FXDF and FXDWG and '09-'10 FXDFSE models equipped with Rigid or H-D Detachables Sideplates and Sissy Bar Uprights.

54055-10	Chrome.	\$149.95
54049-10	Gloss Black.	\$149.95



A. CUSTOM TAPERED SPORT LUGGAGE RACK – CHROME



A. CUSTOM TAPERED SPORT LUGGAGE RACK – GLOSS BLACK

B. H-D® DETACHABLES™ SOLO RACK – CHROME*

Add touring capabilities to your solo seat Dyna model in less than 60 seconds. This detachable Solo Rack fits over the fender when the passenger pillion is removed. The rack features a hand-polished and chrome-plated finish to add a stylish flair. Requires Docking Hardware.

53511-06A	\$209.95
------------------	-----------------

Fits '06-'17 Dyna models (except FLD, FXDF, FXDFSE and '10-'17 FXDWG) equipped with solo seat. Requires separate purchase of appropriate Detachable Docking Hardware. '13-'17 FXDB and models equipped with a side-mount license plate require License Plate Relocation Kit P/N 67900130. Not for use with LED Rear Turn Signal Kit P/N 67800055A or 67800056A. '13-'17 FXDB HDI/India configuration require separate purchase of Docking Hardware and Turn Signal Relocation Kit P/N 67800499. FXDB HDI models require 67800499 Turn Signal Relocation Kit.

C. RIGID SOLO RACK – GLOSS BLACK*

Versatile rigid-mount Solo Luggage Rack features a rich gloss black finish that complements almost any paint color. Equip the contoured rack with a duffel bag for a cross-country solo ride or attach the available H-D® Detachables™ Passenger Pillion P/N 52689-09 for a comfortable two-up tour.

52796-09	\$159.95
-----------------	-----------------

Fits '06-'17 Dyna models with solo seats (except FLD, FXDF, FXDFSE, FXDL and '10-later FXDWG).



B. H-D DETACHABLES SOLO RACK – CHROME



C. RIGID SOLO RACK – GLOSS BLACK



***WARNING:** Do not use this rack as a seat. Do not exceed the fender rack weight capacity. Using as seat or exceeding this capacity could cause handling problems which could result in loss of control and death or serious injury.

Notice: The prices appearing in this catalog are the manufacturer's suggested retail prices. Actual retail prices may vary.

DYNA® 125

Saddlebags

D. H-D® DETACHABLES™ LEATHER SADDLEBAGS

These large capacity detachable saddlebags are completely removable with the simple pull of the internal handle, leaving your bike clean and ready to cruise the boulevard. The handsome leather bags feature hidden quick-release clips behind the traditional strap and buckle. When removed, the large capacity bags leave behind two simple, inconspicuous docking points. The bags are compatible with both rigid and H-D® Detachables™ accessories when installed with the appropriate docking hardware kits. Luggage capacity: 2400 cubic inches total.

90181-08A \$949.95

Fits '02-'17 Dyna® models (except FLD, '02-'05 FXDWG, and '09-'17 FXDB with optional strut covers). '02-'05 models require separate purchase of Mounting Hardware Kit P/N 92025-09. '10-'17 FXDWG models require separate purchase of Turn Signal Relocation Kit P/N 68544-10. '09-'17 FXDB models require separate purchase of Turn Signal Relocation Kit P/N 68227-09. '13-'17 FXDB models equipped with side-mount license plate requires License Plate Relocation Kit P/N 67900130. '16-'17 FXDLS models require separate purchase of Turn Signal Relocation Kit P/N 68227-09 and Side Mount License Plate Kit P/N 60938-10 or 60978-10. All other years and models (except FXDF and FXDWG) require separate purchase of Turn Signal Relocation Kit P/N 68732-02A (Domestic), 68733-02A (International) or Layback License Plate Kit P/N 60215-06. Not for use with Rear Axle Covers on FXDF and FXDWG models.

Also available:

TURN SIGNAL RELOCATION KIT

Required for installation of saddlebags and detachable accessories on '09-later FXDB models.

68227-09 \$109.95

Fits '09-'17 FXDB models (except models with optional fender strut covers).

TURN SIGNAL RELOCATION KIT

Kit moves turn signals from rear fender struts to a license bracket-mounted turn signal bar.

Required to install Saddlebags P/N 91615-09A, 88200-09A, 90181-08A, 90460-06B, 79300-06D, 90564-06D, 90369-06D, and 88343-10. Fits '02-'17 Dyna (except FXDF, FXDWG and '09-'17 FXDB) and '04-later XL models (except XL883N, XL1200N, XL1200NS, XL1200X, XL1200XS and '11-later XL1200C). Does not fit with Layback License Plate Mounting Kits.

68732-02A Domestic \$89.95

68733-02A International \$89.95

Required to install Saddlebags P/N 79078-02, 79300-04B and 91622-03.

68718-02 \$39.95

Fits '02-'05 FXDWG models.

LICENSE PLATE/TURN SIGNAL RELOCATION KIT

Required for installation of Saddlebags.

68544-10 \$249.95

Fits '10-'17 FXDWG models equipped with saddlebags.

LICENSE PLATE RELOCATION KIT

Required for installation of available saddlebags and/or detachable sissy bars on '13-later FXDB models equipped with side-mount license plate. Kit replaces Original Equipment side-mount license plate.

67900130 \$134.95

Fits '13-'17 FXDB models equipped with side-mount license plate.

NOTE: Some Harley-Davidson® saddlebags are made of leather. Fine leathers or other natural materials WILL gain "character," such as wrinkles or wear, with age. This is normal. A fine, aged patina and character wrinkles are a sign of the extremely high quality materials used to construct your saddlebags. The appearance of scars or marks on the leather are a result of using natural leather panels and should not be thought of as an imperfection. Please use Harley-Davidson Leather Protectant P/N 93600034 to protect your investment.

Notice: The prices appearing in this catalog are the manufacturer's suggested retail prices. Actual retail prices may vary.



D. H-D DETACHABLES LEATHER SADDLEBAGS



STEP 1

Equipped with large capacity saddlebags, your bike is ready to take on the longest journey.



STEP 2

Pull and turn the hidden cam lock to release the bags from the docking hardware.



STEP 3

Slide the bag rearward to disengage the mounting bracket and lift the bags away.



STEP 4

You are left with a stripped-down cruiser, ready to prowl the streets.

126 DYNA®

Saddlebags

A. RIGID LOCKING LEATHER SADDLEBAGS

These saddlebags combine a premium leather finish with extra-durable construction. The hard-shell design is covered in leather for a traditional look, while the locking hinged lids offer modern convenience and security. Styled to complement the sleek, narrow Dyna® motorcycle profile, these bags offer plenty of storage for a trip across town or across the country. Kit includes reflectors. Luggage capacity: 2400 cubic inches total.

91615-09A **\$764.95**

Fits '02-'17 Dyna models (except FLD, '02-'05 FXDWG and '09-'17 FXDB with optional strut covers). '02-'05 models require separate purchase of Mounting Hardware Kit P/N 92025-09. '10-'17 FXDWG models require separate purchase of Turn Signal Relocation Kit P/N 68544-10. '09-'17 FXDB models require separate purchase of Turn Signal Relocation Kit P/N 68227-09. '13-'17 FXDB models equipped with side-mount license plate requires License Plate Relocation Kit P/N 67900130. '16-'17 FXDLS models require separate purchase of Turn Signal Relocation Kit P/N P/N 68227-09 and Side Mount License Plate Kit P/N 60938-10 or 60978-10. All other years and models (except FXDF and FXDWG) require separate purchase of Turn Signal Relocation Kit P/N 68732-02A (Domestic), 68733-02A (International) or Layback License Plate Kit P/N 60215-06. Not for use with Rear Axle Covers on FXDF and FXDWG models.



A. RIGID LOCKING LEATHER SADDLEBAGS

B. BAR & SHIELD™ LEATHER SADDLEBAGS

These genuine leather saddlebags deliver style and large capacity all in one. Constructed around a rigid plastic tub for long term durability, the leather bag features a stylish design with lines that enhance the smooth Dyna model profile. The leather saddlebags provide custom looks and tons of storage space for the road. Hidden quick-release closures add packing convenience. Luggage capacity: 2380 cubic inches total.

90369-06D **\$649.95**

Fits '02-'17 Dyna models (except FLD, '02-'05 FXDWG and '09-'17 FXDB with optional strut covers). '02-'05 models require separate purchase of Mounting Hardware Kit P/N 92025-09. '09-'17 FXDB models require separate purchase of Turn Signal Relocation Kit P/N 68227-09. '10-'17 FXDWG models require separate purchase of Turn Signal Relocation Kit P/N 68544-10. '13-'17 FXDB models equipped with side-mount license plate requires License Plate Relocation Kit P/N 67900130. '16-'17 FXDLS models require separate purchase of Turn Signal Relocation Kit P/N P/N 68227-09 and Side Mount License Plate Kit P/N 60938-10 or 60978-10. All other years and models (except FXDF and FXDWG) require separate purchase of Turn Signal Relocation Kit P/N 68732-02A (Domestic), 68733-02A (International) or Layback License Plate Kit P/N 60215-06. Not for use with Rear Axle Covers on FXDF and FXDWG models.



B. BAR & SHIELD LEATHER SADDLEBAGS

C. SYNTHETIC LEATHER SADDLEBAGS

These synthetic leather saddlebags deliver both style and large capacity at a low cost. The rigid plastic tub is wrapped in synthetic leather for long-term durability. The bag features a large protective lid with hook-and-loop and snap closure and an inner pocket for small item storage. Luggage capacity: 2380 cubic inches total.

90564-06D **\$499.95**

Fits '02-'17 Dyna models (except FLD, '02-'05 FXDWG and '09-'17 FXDB with optional strut covers). '02-'05 models require separate purchase of Mounting Hardware Kit P/N 92025-09. '09-'17 FXDB models require separate purchase of Turn Signal Relocation Kit P/N 68227-09. '10-'17 FXDWG models require separate purchase of Turn Signal Relocation Kit P/N 68544-10. '13-'17 FXDB models equipped with side-mount license plate requires License Plate Relocation Kit P/N 67900130. '16-'17 FXDLS models require separate purchase of Turn Signal Relocation Kit P/N P/N 68227-09 and Side Mount License Plate Kit P/N 60938-10 or 60978-10. All other years and models (except FXDF and FXDWG) require separate purchase of Turn Signal Relocation Kit P/N 68732-02A (Domestic), 68733-02A (International) or Layback License Plate Kit P/N 60215-06. Not for use with Rear Axle Covers on FXDF and FXDWG models.



C. SYNTHETIC LEATHER SADDLEBAGS

Notice: The prices appearing in this catalog are the manufacturer's suggested retail prices. Actual retail prices may vary.

DYNA® 127

Saddlebags



D. LEATHER THROW-OVER SADDLEBAG

D. LEATHER THROW-OVER SADDLEBAGS

These traditional Leather Throw-Over Bags feature large side gussets for increased capacity and full-length straps with hidden quick-disconnect clips for easy access.

91008-82C **\$369.95**
Fits '82-later XL (except XL1200T), '08-'17 Dyna® (except FLD) and '84-'99 and '18-later Softail® models equipped with H-D® Chrome Saddlebag Supports.

E. SINGLE-SIDED SWINGARM BAG

Less is more. With enough room for the essentials, these stylish Swingarm Bags eliminate the need to stuff your pockets or bungee a bag across the passenger pillion. Shaped to hug the contour of your bike's frame, these compact bags add an old school look. Bags are constructed of heavyweight leather and feature a pouch-style flap lid that is secured with two quick-disconnect clips that are hidden behind traditional straps and buckles. The semirigid-backed bag is secured to the left side of the bike with easy-to-install brackets and adjustable straps. Luggage capacity: 265 cubic inches total.

90200570 Black Leather. **\$189.95**
Fits '06-'17 Dyna models (except FLD) equipped with Solo Seats. Requires removal of passenger pegs.

F. CHROME SADDLEBAG SUPPORTS

Fit with or without Sissy Bar Uprights, attach easily and protect bags from contacting brake and swingarm.

91017-10A **\$155.95**
Fits '06-'17 Dyna models (except FLD). Does not fit with H-D® Detachables™ sissy bars or racks.

G. SADDLEBAG TRAVEL-PAKS

Water-resistant liners make packing easy. Feature inner pockets for extra storage and an embroidered Bar & Shield logo.

91959-97 **\$59.95**
Liner dimensions: 12.0" W x 10.0" T x 5.0" D.

H. UNIVERSAL SADDLEBAG LOCK KIT

Keep the contents of your existing soft-sided saddlebags safe from the grab-and-go thief. This unique kit features two extra-small barrel locks that can replace existing saddlebag snaps to perform double duty as locks or as snaps when you don't need to lock your bags. Can be keyed to match your barrel-style ignition key. Sold in pairs.

Fits most soft-sided leather and vinyl saddlebags. Does not fit FLHRC and FLHRS.

90300003 Keyed To Match. **\$59.95**
90300017 Random Key Code. **\$49.95**



E. SINGLE-SIDED SWINGARM BAG – BLACK LEATHER



F. CHROME SADDLEBAG SUPPORTS



G. SADDLEBAG TRAVEL-PAKS (91959-97 SHOWN)



H. UNIVERSAL SADDLEBAG LOCK KIT

NOTE: Some Harley-Davidson® saddlebags are made of leather. Fine leathers or other natural materials WILL gain "character," such as wrinkles or wear, with age. This is normal. A fine, aged patina and character wrinkles are a sign of the extremely high quality materials used to construct your saddlebags. The appearance of scars or marks on the leather are a result of using natural leather panels and should not be thought of as an imperfection. Please use Harley-Davidson Leather Protectant P/N 93600034 to protect your investment.

Notice: The prices appearing in this catalog are the manufacturer's suggested retail prices. Actual retail prices may vary.

128 DYNA®

Suspension

A. PREMIUM RIDE SINGLE CARTRIDGE FORK KIT*

This Single Sided Cartridge Fork provides improved handling performance by keeping the tire in contact with the road surface. Tuned to work in concert with the Premium Emulsion Rear Shocks, the fork damping is controlled by a specifically calibrated piston and valve stack. Unlike typical orifice damping, the piston/valve system helps the cartridge fork achieve a linear damping force curve for consistent feel throughout the compression and extension of the front suspension. The cartridge allows the forks to react quickly to rough roads, inspiring rider confidence in sweeping corners. The compression piston provides excellent low speed damping for a better rider feel, and the rebound spring provides a smoother feel during topping. The cartridge fork resists bottoming and dive, and the triple rate spring and oil lock allows the forks to absorb bumps even under hard braking – giving the rider more control while resisting wheel hop. A perfect addition during the installation of chrome or gloss black lower fork sliders, the kit includes fork pipe, cartridge, fork bolts, main springs and oil seals.

45400058 **\$349.95**

Fits '06-'17 Dyna® models (except FLD, FXDWG and '07-'08 FXDSE). Original Equipment on FXDLS models.

B. PREMIUM RIDE EMULSION SHOCKS*

Experience a comfortable and confidence-inspiring ride – no matter the pavement conditions – with Harley-Davidson® Premium Ride Emulsion Shocks. These fast acting mono-tube nitrogen gas-charged shocks offer enhanced compression and rebound damping control when compared to typical twin-tube shock absorbers. The nitrogen gas charged shocks resist oil aeration and work with the internal valve stack to provide superior damping control in the twisties. The large 36mm pistons and low viscosity high-performance oil allow these shocks to react quickly to impacts and keep the tires tracking the road surface. You get a controlled ride and minimized bottoming harshness transmitted through the frame. The locking threaded adjustment lets you fine tune the spring preload to your current riding conditions – whether a solo run on the back roads or a fully-loaded two-up freeway tour – and urethane bumpers provide a softer feel if the shock bottoms under load. The beautifully-finished shocks feature black-anodized billet top caps and black progressively-wound springs. Kit includes left and right shock and preload adjustment spanner wrench.

54000066 Stock Height. **\$599.95**

Fits '06-'17 Dyna models (except FLD and '07-'08 FXDSE). Original Equipment on FXDLS models.



A. PREMIUM RIDE SINGLE CARTRIDGE FORK KIT



B. PREMIUM RIDE EMULSION SHOCKS



***WARNING:** Installation of any accessory suspension components may affect cornering clearance and jiffy stand operation. This could distract the rider, causing loss of control and death or serious injury.



***WARNING:** The Profile Low Front Spring Kit cannot be used independently and must be used with the appropriate Profile Rear Shock Lowering Kit. Installation of any accessory suspension components may affect cornering clearance and jiffy stand operation. This could distract the rider, causing loss of control and death or serious injury.

Notice: The prices appearing in this catalog are the manufacturer's suggested retail prices. Actual retail prices may vary.

DYNA® 129

Foot Controls

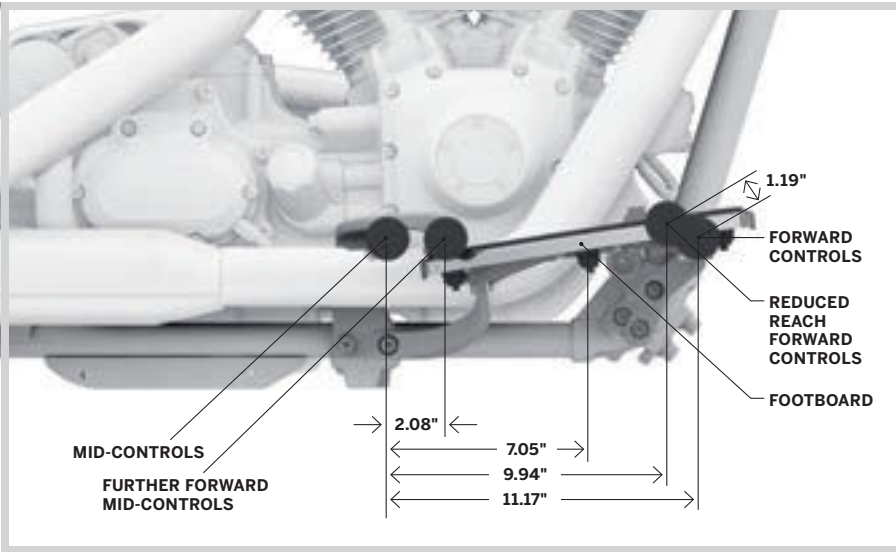

FOOT CONTROL POSITION COMPARISON

DYNA® FOOT CONTROL*

A long stretch to the controls or a knees-high cramped riding position puts strain on your body after even a short ride. Repositioning your feet on the controls relieves muscle tension, takes pressure off the tail bone, and reduces rider fatigue. Where your feet contact the controls can often determine how many miles you can put on in a day.

Dyna® models can be equipped with the following foot control configurations:

MID-CONTROLS:

Positions the feet below the knee for a sporting riding posture.

FURTHER FORWARD MID-CONTROLS:

Achieves a comfortable foot-down riding position for the taller rider.

REDUCED REACH FORWARD CONTROLS:

Provides a foot-forward boulevard style without straining to reach the controls.

STANDARD FORWARD CONTROLS:

Stretches the legs for a "feet-in-the-wind" laid back profiling posture.

FLOORBOARDS:

Supports the entire foot and places the rider in a comfortable upright position.



STANDARD FORWARD CONTROLS



REDUCED REACH FORWARD CONTROLS



FURTHER FORWARD MID-CONTROLS



***WARNING:** Installation of accessory Forward Control Kits may affect cornering clearance. This could distract the rider, causing loss of control, resulting in death or serious injury.

Notice: The prices appearing in this catalog are the manufacturer's suggested retail prices. Actual retail prices may vary.

130 DYNA®

Foot Controls

A. STANDARD FORWARD CONTROLS*

Stretch out for maximum comfort and style. This complete kit includes all components necessary to convert a mid-control equipped Dyna® model to forward controls. Moves controls 11.0" forward from mid-control foot position. Kit is available in chrome or gloss black to match your customizing style.

Fits '06-'17 Dyna models with mid-controls. FLD models require separate purchase of footpegs.

49080-06A	Chrome.	\$399.95
49021-09	Gloss Black.	\$399.95

Fits '93-'05 Dyna models. Stock on '03-'05 FXDWG models. Not for use with Engine Guard on FXD and FXDL models.

49080-03A	Chrome.	\$399.95
------------------	---------	-----------------



A. STANDARD FORWARD CONTROLS – CHROME



A. STANDARD FORWARD CONTROLS – GLOSS BLACK

B. REACH® FORWARD CONTROL KIT*

Want to stretch the riding position of your mid-control equipped model, but not comfortable with the long reach to factory-position forward controls? This complete kit is the perfect alternative. It positions the feet up and forward 10.0" from the mid-control position, but 1.0" closer to the rider than the standard position factory forward controls, placing the rider's boot at a comfortable pivot point for improved support and leverage. Available in chrome or gloss black finish, the kit includes left and right footpeg supports, brake and shift lever assemblies, brake and shift linkages and all required hardware.

Fits '06-'17 Dyna models equipped with mid-controls. FLD models require separate purchase of footpegs.

50700008	Chrome.	\$449.95
50700007	Gloss Black.	\$449.95



B. REACH FORWARD CONTROL KIT – CHROME



B. REACH FORWARD CONTROL KIT – GLOSS BLACK

C. REACH FORWARD CONTROL CONVERSION KIT*

Love the look and riding position you get with forward controls but not comfortable with the long stretch forward? This Forward Control Conversion Kit repositions the Original Equipment footpegs and foot controls up and back by over 1.0", positioning the controls closer to the rider for added comfort and confidence. The reduced reach places the rider's boot at the proper pivot point for improved leverage, while maintaining the "foot-forward" riding profile. This easy-to-install Conversion Kit includes heavy-duty steel mounts and shortened brake rod. Kit reuses Original Equipment control supports and brake and shift levers or can be personalized with your choice of custom lever styles.

50700005		\$174.95
-----------------	--	-----------------

Fits '03-'17 Dyna models (except FLD) equipped with forward controls.



C. REACH FORWARD CONTROL CONVERSION KIT



D. FURTHER FORWARD MID-CONTROL KIT

D. FURTHER FORWARD MID-CONTROL KIT*

Feel a little cramped when your feet are placed on the standard-location mid-controls? This kit repositions the controls 2.0" forward of the stock location, eliminating the "knees-high" riding attitude while maintaining a sporty upright riding posture. The forward location provides an open path for your feet to aid maneuvering the bike while parking and improves access to the jiffy stand for a shorter rider. Kit includes chrome left and right footrest brackets, highly polished brake lever and chrome shift lever. Use stock footpegs, brake and shift linkages or, choose from other Dyna collection offerings to complete your look.

50500386		\$349.95
-----------------	--	-----------------

Fits '06-'17 Dyna models with mid-controls. Original Equipment riding position on '14-'17 FXDL and FXDLS models.



***WARNING:** Installation of accessory Forward Control Kits may affect cornering clearance. This could distract the rider, causing loss of control, resulting in death or serious injury.

Notice: The prices appearing in this catalog are the manufacturer's suggested retail prices. Actual retail prices may vary.



E. BILLET STYLE SHIFT LEVER – CHROME



E. BILLET STYLE SHIFT LEVER – EDGE CUT



E. BILLET STYLE SHIFT LEVER – SATIN BLACK



F. RIDER FOOTBOARD KIT



G. RIDER FOOTBOARD HEEL GUARD



H. REAR MASTER CYLINDER COVER – CHROME



I. RIDER FOOTPEG HEEL RESTS



J. JIFFY STAND EXTENSION KIT

E. BILLET STYLE SHIFT LEVER

Styled to complement our billet style mirror stems, these Billet Style Shift Levers are forged from 6061-T6 aluminum, then machined and finished in chrome, satin black or edge cut styles for a beautiful, custom look. Includes chrome hardware.

Fits '91-'17 Dyna® (except '14-'17 FXDL, FXDLS or models equipped with Further Forward Mid-Control Kit P/N 50500386) and '90-'17 FX Softail® models.

34539-00	Chrome.	\$89.95
34043-10	Edge Cut.	\$89.95
34016-08	Satin Black.	\$89.95

F. RIDER FOOTBOARD KIT

Convert your Dyna® model to touring-oriented footboard-based controls. Ideal for riders with an inseam too long for mid-controls or for riders who prefer the extra foot room on long rides, this complete kit moves the foot brake and shift lever forward from the standard position. The installation places the rider into a comfortable upright posture with a flat foot and bent knee profile. This position provides additional support by allowing the legs to take some of the rider's weight, while providing the freedom to reposition the feet during the ride. The kit includes left and right footboards with inserts, footboard supports, brake lever, brake and shift linkage, brake pedal pad and all required hardware. Installation reuses Original Equipment shift lever. Customize the look by adding your choice of accessory traditional D-shaped rider footboard inserts and large brake pedal pads.

50500247 **\$399.95**
Fits '06-'17 FXD, FXDB and FXDC, '06-'13 FXDL and '06-'08 FXDWG models. Stock on '12-'16 FLD models. Fits '17 FXDBP and FXDBC. Does not fit with frame mounted highway pegs.

G. RIDER FOOTBOARD HEEL GUARD

Avoid damaged boots and hours of cleaning melted rubber scuff marks from your exhaust shield. This Heel Guard mounts to the right-side rider footboard and protects your boot from contact with the hot exhaust shield. The subtle curved shape keeps the boot heel away without restricting fore-and-aft movement of the rider's foot. Kit includes chrome guard with cutaway Bar & Shield logo and all mounting hardware.

50500225 **\$69.95**
Fits '12-'16 FLD, '86-'17 FL Softail, '86-later Touring and '09-later Trike models equipped with Traditional and Swept Wing footboards. Does not fit models equipped with Half-Moon, Tapered, Airflow, Defiance or Burst footboards, Extended Reach Rider Footboards P/N 50409-04 or 54145-10, Rider Running Boards P/N 50500158 or Screamin' Eagle® Fat Exhaust Shields.

H. REAR MASTER CYLINDER COVER – CHROME

An easy way to add chrome to your bike with this chrome-plated version of the stock master cylinder cover.

46425-05A **\$39.95**
Fits '06-later Dyna non-ABS models, '06-later Softail and '05-'07 Touring models.

I. RIDER FOOTPEG HEEL RESTS

Give your feet a rest while you're stretching out on your forward controls. These adjustable billet-style Rider Footpeg Heel Rests reduce fatigue and make you look as good as you feel. Just add a pair of matching shifter pegs to complete the custom look (sold separately).

50227-01 **\$139.95**
Fits '93-'02 FXDWG and '89-'17 FX Softail models. Also fits Dyna models equipped with Forward Control Kit P/N 49080-06A, 49021-09 or 49080-93A.

J. JIFFY STAND EXTENSION KIT

Jiffy Stand Extension kits have been ergonomically designed to simplify the deployment and retraction of the jiffy stand. The extension is shaped to simplify locating the tab with your boot and aid in swinging the jiffy stand into position. The move feels natural and adds confidence when parking your motorcycle in a tight spot. Kit mounts to Original Equipment jiffy stand and includes all required mounting hardware.

50000032 **\$39.95**
Fits '93-'17 Dyna models (except FXDFSE, FXDS-CONV, FXDSE, FXDWG2, FXDWG3, FXDX, FXDXT, '99-'00 FXR and '01-'04 FXDL).

132 DYNA®

Foot Controls

A. PASSENGER FOOTPEG SUPPORT KIT – WRINKLE BLACK

Add footpegs to your solo seat-equipped Dyna® motorcycle. Kit includes left and right footpeg supports and mounting hardware. Footpegs and footpeg hardware sold separately.

Fits '06-'17 Dyna models.

50210-06	Wrinkle Black.	\$79.95
49249-06	Chrome.	\$129.95



A. PASSENGER FOOTPEG SUPPORT KIT – WRINKLE BLACK



B. PASSENGER FOOTPEG SUPPORT KIT – CHROME

B. ADJUSTABLE PASSENGER FOOTPEG MOUNT KIT

Maximize your passenger's riding comfort. Proper foot position reduces the cramped or stretched-out feeling and relieves pressure on the knees and the tail bone. These Adjustable Mounts raise and lower the passenger footpeg to accommodate taller and shorter passengers. Easy to adjust with common tools, the mount adjusts through a 360° range (depending on model), allowing both fore and aft and up and down height adjustment. Kit includes left and right adjustable support assembly and all required mounting hardware. Footpegs sold separately.

50763-09 **\$149.95**

Fits models with H-D® male-mount style passenger footpeg supports (except Softail® models). Does not fit with Heel Raiser Footpeg Kit P/N 50178-09. Does not fit the rider position.



B. ADJUSTABLE PASSENGER FOOTPEG MOUNT KIT



C. PASSENGER FOOTBOARD SUPPORT KITS

C. PASSENGER FOOTBOARD SUPPORT KIT

Add the comfort and convenience of passenger footboards to your Dyna motorcycle. This Support Kit is designed to allow installation of Traditional D-Shape, Swept Wing, Tapered or Old-Style Passenger Footboards (sold separately) on Dyna models. Kit includes left and right supports, footboard mount hinge pins and installation hardware.

Fits '06-'17 Dyna models.

49279-06	Chrome.	\$239.95
49349-07	Black.	\$199.95

D. PASSENGER FOOTBOARD PANS – CHROME

Replace the factory black painted passenger footboard with the custom look of smooth chrome. The kit includes left- and right-hand traditional D-shaped footboard pans, chrome-plated and ready to install with your Original Equipment hardware. Footboard inserts and footboard supports sold separately.

50752-04 **\$169.95**

Fits '06-'17 Dyna, '00-later Softail (except FXDRS) and '86-later Touring and Trike models equipped with passenger footboard supports.



D. PASSENGER FOOTBOARD PANS – CHROME



E. SWEEP WING PASSENGER FOOTBOARD PANS – CHROME GROOVED

E. SWEEP WING PASSENGER FOOTBOARD PANS

These unique Swept Wing Passenger Footboard pans complement the Swept Wing Rider Footboard shape and allow you to replace the Original Equipment passenger footpegs on certain models with footboards. When folded, the footboard displays a mirror chrome surface in your choice of smooth or "ball-milled" grooved design. Footboard inserts and footboard supports sold separately.

Fits '06-'17 Dyna, '00-later Softail (except FXDRS) and '86-later Touring models equipped with passenger footboard supports. Does not fit Trike models.

50357-04	Chrome – Grooved.	\$169.95
50716-04	Chrome – Smooth.	\$169.95



E. SWEEP WING PASSENGER FOOTBOARD PANS – CHROME SMOOTH

F. HALF-MOON PASSENGER FOOTBOARD PANS AND INSERTS

Styled to match the Half-Moon Rider Footboards, these classic passenger footboards add both style and comfort to your nostalgic ride. Available in mirror-finish chrome or gloss black finish, the kit includes left and right footboard pan and vibration-isolation footboard inserts. Model-specific footboard mounts are sold separately.

Fits '06-'17 Dyna, '00-later Softail (except FXDRS) and '86-later Touring models equipped with passenger footboard supports. Does not fit Trike models.

50807-08	Chrome.	\$189.95
50810-08	Gloss Black.	\$189.95



F. HALF-MOON PASSENGER FOOTBOARD PANS – CHROME



F. HALF-MOON PASSENGER FOOTBOARD PANS – GLOSS BLACK



***WARNING:** Do not use highway pegs under normal stop and go operating conditions. Doing so could result in death or serious injury.

Notice: The prices appearing in this catalog are the manufacturer's suggested retail prices. Actual retail prices may vary.



G. MINI FOOTBOARD KIT – (LARGE CHROME SHOWN)



G. MINI FOOTBOARD KIT – (LARGE BLACK SHOWN)



G. MINI FOOTBOARD KIT



H. ADJUSTABLE HIGHWAY PEG MOUNTING KIT



I. HIGHWAY PEG MOUNTING KIT

G. MINI FOOTBOARD KIT*

This Footboard Kit can be installed in place of traditional footpegs and provides a little additional leg support and more options to move your legs around on a long ride. Mini Footboards mount to the standard H-D® style footpeg supports and can be used in many rider, passenger and highway peg applications. Sole-gripping rubber complements Original Equipment or accessory footboards and footpegs and adds vibration isolation and a rich appearance.

Fits rider position:

'02-'17 VRSC™ models with forward controls (except VRSCDX and VRSCF), '15-later XG models (except XG750A), '06-earlier XL, '07-'10 XL883, XL883C, XL883R, XL1200C, XL1200R and '07-'11 XL1200L, '91-'17 Dyna® models (except FLD) and '84-'17 Softail® models with forward controls (except FXCW, FXCWC, FXS, FXSB or FXSBSE).

Fits passenger position:

All models with H-D male-mount passenger peg mounts (except '06-earlier VRSC, '03-earlier XL, '05-earlier Dyna and Softail models equipped with Shotgun exhaust). '84-'17 Softail models require separate purchase of Support Kit P/N 50454-09. Does not fit passenger position on '18-later Softail models.

Fits highway peg position:

All models with frame-mount or engine guard-mount highway pegs (except Whiskers Adjustable Highway Bar P/N 50855-09 and 50865-09).

50500139	Small 3.0" – Chrome.	\$129.95
50500144	Small 3.0" – Gloss Black.	\$129.95
50500109	Large 4.0" – Chrome.	\$129.95
50500124	Large 4.0" – Gloss Black.	\$129.95

H. ADJUSTABLE HIGHWAY PEG MOUNTING KIT*

Versatility with style and comfort. Choose from several H-D custom footpegs to complete the cruiser look. Easy to install.

49002-98 **\$159.95**

Fits '93-'17 Dyna models with Original Equipment mid-controls or Further Forward Mid-Control Kit P/N 50500386. Will not fit models equipped with engine guards.

I. HIGHWAY PEG MOUNTING KIT*

Kick back and cruise. Kit includes chrome mounting plates, chrome footpeg supports and all necessary mounting hardware. Uses H-D male-mount footpegs.

49019-95 **\$159.95**

Fits '93-'17 Dyna models with Original Equipment mid-controls or Further Forward Mid-Control Kit P/N 50500386. Will not fit models equipped with engine guards.

! *WARNING: Do not use highway pegs under normal stop and go operating conditions. Doing so could result in death or serious injury.

Notice: The prices appearing in this catalog are the manufacturer's suggested retail prices. Actual retail prices may vary.

DYNA

134 DYNA®

Engine Guards

A. ENGINE GUARD KIT*

Protect your bike without sacrificing ground clearance or style. The one-piece Engine Guard is designed to complement the lines of the motorcycle and the available chrome or gloss black finish adds the perfect finishing touch.

For use with the mid or forward controls. Fits '06-'17 Dyna® models. '14-'17 FXDL, FXDLS (all markets) and '15-'17 Dyna (India models only) require separate purchase of Horn Relocation Bracket P/N 69000058. Fits with Oil Cooler Kit P/N 26151-07B. '07-'08 FXDSE and '09-'10 FXDFSE requires removal of front chin spoiler and separate purchase of Regulator Caddy P/N 70464-08A. '06-'11 models equipped with evap canister also require separate purchase of Canister Bracket P/N 47207-06. '12-'17 models equipped with evap canister require separate purchase of Canister Relocation Kit P/N 60800005.

49010-06	Chrome.	\$219.95
49320-09	Gloss Black.	\$219.95

Also available:

EVAPORATIVE CANISTER RELOCATION KIT

60800005 **\$29.95**

Required when mounting Engine Guard P/N 49320-09 or 49010-06 on '12-'17 Dyna models designated for California and Asia-Pacific markets.



A. ENGINE GUARD KIT – CHROME



A. ENGINE GUARD KIT – GLOSS BLACK

B. MUSTACHE ENGINE GUARD*

Combine classic shape and modern function for a unique twist on engine protection. The flow of this engine guard complements the bike's traditional style while the gracefully curved upper section incorporates highway pegs into the shape. The integrated rubber pads offer a comfortable and slip-resistant cushion for your feet while traveling the open road. One-piece engine guard kit includes all required mounting hardware.

Fits '06-'17 Dyna models. '14-'17 FXDL, FXDLS (all markets) and '15-later Dyna (India models only) require separate purchase of Horn Relocation Bracket P/N 69000058. Fits with Oil Cooler Kit P/N 26151-07B. '07-'08 FXDSE and '09-'10 FXDFSE requires removal of front chin spoiler and separate purchase of Regulator Caddy P/N 70464-08A. '06-'11 models equipped with evap canister also require separate purchase of Canister Bracket P/N 47207-06. '12-'17 models equipped with evap canister require separate purchase of Canister Relocation Kit P/N 60800005.

49000077	Chrome.	\$289.95
49000078	Gloss Black.	\$289.95

Also available: (not shown)

HORN BRACKET ADAPTER

Required when mounting Engine Guard P/N 49010-06, 49320-09, 49000077, or 49000078 on '14-later FXDL (all markets) and '15-later Dyna (India models only).

69000058 **\$9.95**

Fits '14-'17 FXDL and FXDLS (all markets) and '15-'17 Dyna (India models only) equipped with Engine Guard P/N 49010-06, 49320-09, 49000077 or 49000078.



B. MUSTACHE ENGINE GUARD – CHROME



B. MUSTACHE ENGINE GUARD – GLOSS BLACK

C. SWITCHBACK™ REAR SADDLEBAG GUARDS – CHROME*

Add protection and style to your ride. These chrome guards add a traditional Bagger look to the Dyna Switchback™ model and protect the leading edge of the saddlebags. The innovative design allows the guards to be removed with the detachable saddlebags for a stripped-down look and the integrated stand keeps the bags upright and off the ground when off the bike. Kit includes left and right guards and all necessary mounting hardware.

90201044	\$299.95
-----------------	-----------------

Fits '12-'16 FLD models.



***WARNING:** Do not use highway pegs under normal stop and go operating conditions. Doing so could result in death or serious injury.



***WARNING:** These guards may provide limited leg and cosmetic vehicle protection under unique circumstances (fall over while stopped, very low speed slide). They are not made nor intended to provide protection from bodily injury in a collision with another vehicle or any other object.



C. SWITCHBACK REAR SADDLEBAG GUARDS – CHROME



Notice: The prices appearing in this catalog are the manufacturer's suggested retail prices. Actual retail prices may vary.



D. LOWER FORK SLIDERS – CHROME ('06 DYNA SHOWN)

D. LOWER FORK SLIDERS – CHROME

Competitively priced, these chrome-plated Lower Fork Sliders give your bike up-front style. A perfect addition during the installation of Premium Ride Front Suspension components. To ensure proper fitment and function, these sliders are manufactured from Original Equipment components. Form follows function, with polished, triple chrome-plating and a stamped Harley-Davidson logo for product identification. Includes right and left side sliders.

45500267 **\$449.95**
Fits '14-'17 FXDL and FXDLS models with dual disc brakes.

45500064 **\$449.95**
Fits '06-'17 Dyna® models (except FLD, FXDF, FXDLS, FXDWG, FXDFSE, FXDSE and '14-later FXDL).

45500065 **\$469.95**
Fits '08-'17 FXDF models.

45500066 **\$449.95**
Fits '06-'17 FXDWG models.

45500067 **\$449.95**
Fits '12-'16 FLD models.

46477-00 **\$449.95**
Fits '00-'05 FXDWG and '00-'06 FXST and FXSTB models.

E. FRONT END KIT – CHROME

The front forks on a Harley-Davidson® motorcycle set the tone for the bike and can lead the way to a full-bore custom statement. So start customizing by adding chrome where it counts. A perfect addition during the installation of Premium Ride Front Suspension components, the kit includes fork sliders, chrome dust caps, axle nut covers and upper fork nut covers. Chrome Front End Package price does not include labor or supplies.

45800076 **\$549.95**
Fits '14-'17 FXDL and FXDLS models with dual disc brakes.

F. FRONT END KIT – GLOSS BLACK

Lead the way to the dark side. This complete blacked-out Front End Kit includes all the major components required to convert the Original Equipment satin-finished front end to a dark custom style. A perfect addition during the installation of Premium ride Front suspension components, the kit includes gloss black fork sliders, gloss black fork dust covers and gloss black front axle nut cover kit.

45800075 **\$549.95**
Fits '14-'17 FXDL models with dual disc brakes. Original Equipment on FXDLS.

45800010 **\$549.95**
Fits '08-'17 FXDWG models. Includes gloss black upper fork nut covers.

45800011 **\$549.95**
Fits '08-'17 Dyna models (except FLD, FXDF, FXDFSE, FXDLS, FXDSE, FXDWG and '14-later FXDL).



E. FRONT END KIT – CHROME (45800076 SHOWN)



F. FRONT END KIT – GLOSS BLACK (45800075 SHOWN)

Notice: The prices appearing in this catalog are the manufacturer's suggested retail prices. Actual retail prices may vary.

136 DYNA®

Chassis Trim – Front End

FRONT AXLE NUT COVERS

Cover the front axle in style. Available in your choice of styles, these custom Axle Nut Covers look great with Original Equipment satin-finish fork sliders or add the finishing touch to a complete chrome or blacked-out front end. Easy to install kits include all necessary mounting hardware. Sold in pairs.

Fits '02-'11 VRSC™ (except VRSCF and VRSCR), '15-later XG, '08-later XL, '08-'17 Dyna®, '07-later Softail® (except Springer™, FLSTNSE, FXCW, FXCWC, FXSB, FXSBSE, FXSE, FXST-Aus, and FXSTD) and '08-later Touring and Trike models. '18-later FLDE, FLFB, FLFBS, FLHC, FLHCS, FLSE, FLSE, FLSE, FXBB, FXBR, FXBRS and FXLR models require separate purchase of Front Axle Adapter Kit P/N 43000090. '19-later FXDRS and '18-later FXFB and FXFBS models require separate purchase of Front Axle Adapter Kit P/N 43000159.

A. DOMINION™ COLLECTION

Express your bold, renegade attitude. The machined aluminum Dominion™ Collection Front Axle Nut Covers add style to the front of the bike and are the perfect complement to other Dominion Collection accessories.

43000124	Gloss Black.	\$74.95
43000123	Bronze.	\$74.95

B. FRONT AXLE NUT COVERS

1. 44117-07A	Chrome – Die-cast.	\$29.95
44116-07A	Chrome – Billet.	\$44.95
2. 43000098	Satin Chrome.	\$29.95
3. 43000026	Gloss Black – Die-cast.	\$29.95
43428-09	Gloss Black – Billet.	\$44.95
4. 43000062	Defiance Chrome.	\$74.95
5. 43000064	Defiance Machine Cut.	\$74.95
6. 44148-07A	H-D Motor Co.	\$31.95
7. 43000031	Burst.	\$69.95
8. 44114-07	Aluminator.	\$44.95

Also available:

Willie G Skull

Fits '02-'11 VRSC (except VRSCF and VRSCR), '15-later XG, '08-later XL (except '16-later XL1200X and XL1200XS), '08-'17 Dyna, '07-later Softail (except Springer, FLSTNSE, FXCW, FXCWC, FXSB, FXSBSE, FXSE, FXST-Aus, and FXSTD) and '08-later Touring and Trike models. '18-later FLDE, FLFB, FLFBS, FLHC, FLHCS, FLSE, FLSE, FLSE, FXBB, FXBR, FXBRS and FXLR models require separate purchase of Front Axle Adapter Kit P/N 43000090. '19-later FXDRS and '18-later FXFB and FXFBS models require separate purchase of Front Axle Adapter Kit P/N 43000159.

9. 43000096	Black.	\$34.95
10. 43163-08A	Chrome.	\$34.95

Brass Collection

11. 43000046 **\$54.95**

Fits '02-'11 VRSC (except VRSCF and VRSCR), '15-later XG, '08-later XL (except '16-later XL1200X and XL1200XS), '08-'17 Dyna, '07-later Softail (except Springer, FLSTNSE, FLSE, FXCW, FXCWC, FXDRS, FXFB, FXFBS, FXSB, FXSBSE, FXSE, FXST-Aus, and FXSTD) and '08-later Touring and Trike models. '18-later FLDE, FLFB, FLFBS, FLHC, FLHCS, FLSE, FLSE, FLSE, FXBB, FXBR, FXBRS and FXLR models require separate purchase of Front Axle Adapter Kit P/N 43000090.

Also available: (not shown)

FRONT AXLE NUT COVERS

Fits '04-'07 Dyna (except '07 FXDSE and '04-'05 FXDWG) and '00-'07 Touring models.

43062-04	Chrome – Die-cast.	\$29.95
43061-04	Chrome – Billet.	\$44.95
43063-04	H-D Motor Co. Logo.	\$29.95

Fits '88-'07 XL, '91-'03 FXD, FXDX, FXDXT, FXDL, FXDSCONV, '93-'05 FXDWG, '88-'07 FXR, '87-later FLXR, FXRS-SP and FXWG, '84-'06 Softail (except Springer and FXSTD) and '80-'99 Touring models.

43899-86A	Chrome – Die-cast.	\$29.95
------------------	--------------------	----------------



A. DOMINION FRONT AXLE NUT COVERS – GLOSS BLACK



A. DOMINION FRONT AXLE NUT COVERS – BRONZE



B. FRONT AXLE NUT COVERS

Notice: The prices appearing in this catalog are the manufacturer's suggested retail prices. Actual retail prices may vary.



NEW

C. DOMINION FORK NUT COVERS – GLOSS BLACK



NEW

C. DOMINION FORK NUT COVERS – BRONZE

C. DOMINION™ COLLECTION FORK NUT COVERS

Top it off with style. These easy to install Fork Stem Covers top of the triple tree for a cohesive look. A perfect complement to other Dominion™ Collection Accessories, these Fork Nut Covers provide the finishing touch to your bike's front end. Sold in pairs.

Fits '06-'17 Dyna® models (except FXDB and FXDSE) and '18-later Softail® models (except FXDRS, FXFB, FXFBS, and FL5B). Also fits '88-'13 XL (except XL1200CX, XL1200X, XL883N) '95-'05 FXD, '93-'05 FXDL, '16-later FXDLS, '94-'05 FXDS-CONV, '90-'17 FLS, FLSS, FLSTF, FLSTFB, FLSTFBS and FLSTN, and '86-'17 FLSTC models.

45800117	Gloss Black.	\$74.95
45800118	Bronze.	\$74.95



NEW

D. DEFIANCE COLLECTION UPPER FORK STEM COVERS – CHROME



NEW

D. DEFIANCE COLLECTION UPPER FORK STEM COVERS – GLOSS BLACK

D. DEFIANCE COLLECTION UPPER FORK STEM COVERS

Top it off with style. These easy to install Fork Stem Covers continue the Defiance Collection to the top of the triple tree for a cohesive look. The deep radial grooves define the style of the Defiance Collection, and the choice of chrome, black or machine cut finishes complement your bike's polished, chrome or blacked-out front end components. Sold in pairs.

Fits '06-'17 Dyna models and '18-later Softail models (except FXDRS, FXFB, FXFBS, and FL5B). Also Fits '88-'13 XL (except XL1200CX, XL1200X, XL883N) '95-'05 FXD, '93-'05 FXDL, '16-later FXDLS, '94-'05 FXDS-CONV and '90-'17 FLS, FLSS, FLSTF, FLSTFB, FLSTFBS and FLSTN and '86-'17 FLSTC models.

45500514	Chrome.	\$49.95
45500515	Gloss Black.	\$49.95
45500516	Black Machine Cut.	\$59.95



NEW

D. DEFIANCE COLLECTION UPPER FORK STEM COVERS – BLACK MACHINE CUT



E. UPPER FORK NUT COVERS – GLOSS BLACK

E. UPPER FORK NUT COVERS

Highlighted with a unique Bar & Shield logo, these easy-to-install billet-look covers hide the Original Equipment fork and steering stem hex-head hardware and add a clean custom touch to the top of the triple tree. Available in your choice of chrome or gloss black finish, the kit comes complete with three covers and mounting hardware.

45800015	Gloss Black.	\$59.95
-----------------	--------------	----------------

46109-06	Chrome.	\$59.95
-----------------	---------	----------------

46129-98B	Chrome.	\$59.95
------------------	---------	----------------

Fits '88-'13 XL (except XL883C, XL1200C and XL1200S), '06-'17 Dyna models (except FLD, FXDB and FXDSE), '95-'05 FXD, '93-'05 FXDL, '16-'17 FXDLS, '94-'05 FXDS-CONV and '90-'17 FLS, FLSS, FLSTF, FLSTFB, FLSTFBS, and FLSTN and '86-'17 FLSTC models.

F. BRASS COLLECTION UPPER FORK STEM COVERS

The ideal addition to your stripped down bobber or café bike build, these easy-to-install solid brass covers hide the Original Equipment fork and steering stem hex-head hardware and add a clean custom touch. Artistically manufactured from solid brass, these Upper Fork Covers feature a natural antique finish that will age and patina when exposed to the elements. Kits includes mounting hardware.

45500308	Three-Piece Kit.	\$79.95
-----------------	------------------	----------------

Fits '88-'13 XL (except XL883C, XL1200C and XL1200S), '95-'05 FXD, '93-'05 FXDL, '94-'05 FXDS-Conv, and '90-'17 FLS, FLSS, FLSTF, FLSTFB, FLSTFBS, and FLSTN and '86-'17 FLSTC models.



E. UPPER FORK NUT COVERS – CHROME



F. BRASS COLLECTION UPPER FORK STEM COVERS

Notice: The prices appearing in this catalog are the manufacturer's suggested retail prices. Actual retail prices may vary.

138 DYNA®

Chassis Trim – Front End

A. BILLET FORK SLIDER DUST COVERS

Oversized billet covers are designed to replace the Original Equipment dust caps, creating a big, beefy look to the front forks. Available in your choice of mirror chrome or gloss black finish, these covers are the perfect addition to matching accessory fork sliders and upper fork nut covers.

Fits '06-'17 Dyna® models (except FLD and FXDSE). Does not fit with Screamin' Eagle® Chrome Fork Brace P/N 46634-06 or 46595-06A and Turn Signal Relocation Kit P/N 69433-08A.

46889-06	Chrome.	\$69.95
45800014	Gloss Black.	\$69.95



A. BILLET FORK SLIDER DUST COVERS – CHROME



A. BILLET FORK SLIDER DUST COVERS – GLOSS BLACK

B. SCREAMIN' EAGLE® FORK BRACE

These chrome Fork Braces are machined from billet aluminum, then polished and chrome-plated to complement the curve of the front fender. The machined Screamin' Eagle logo finishes the look with crisp detail. Easy to install, these braces offer increased torsional rigidity.

46595-06A \$229.95

Fits '02-'08 VRSCA, VRSCB, VRSCD, VRSCX and '06-'17 FXD, FXDB, FXDC, FXDL and FXDLS models.

46192-99A \$229.95

Fits '87-later XL (except XL883N, XL883L, XL1200CX, XL1200N, XL1200T, XL1200X, '11-later XL1200C), '91-'05 Dyna (except FXDWG) and FXR models (except FXRT) with 39mm front forks. (Will not fit with Chrome Fork Sliders).



B. SCREAMIN' EAGLE FORK BRACE



C. CUSTOM FORK BRACE

C. CUSTOM FORK BRACE

This chrome-plated Fork Brace adds style to the front end. The cross-brace open web style reflects a performance heritage and the multi-piece design allows easy installation.

46097-98 41mm. \$159.95

Fits '93-'05 FXDWG and '84-'17 FX Softail® models (except Springer™, FXCW, FXCWC, FXS, FXSB, FXSBSE, FXSE and FXSTD). (Will not fit with Chrome Lower Fork Sliders.)

D. FORK AXLE RETAINER NUT KIT – CHROME

It's the details that count. Complete the chrome transformation by adding this finishing touch to your chrome fork sliders. This Fork Axle Retainer Nut Kit includes the stylish chrome-plated nuts and chrome lockwashers necessary to replace the stock hardware.

45813-03 \$8.95

Fits '91-'05 FXDWG, '86-'07 FLST, FLSTC, FLSTF and FLSTN, '91-'07 FXST and FXSTB, '07 FXST and '84-'13 Touring and Trike models.



D. FORK AXLE RETAINER NUT KIT – CHROME

E. FORK SLIDER DRAIN SCREW KIT – CHROME

This Fork Slider Drain Screw Kit includes two chrome-plated drain screws and the seals required to replace the stock hardware.

45848-03 \$3.95

Fits '93-'05 FXDWG, '87-'17 Softail (except Springer, FXCW, FXCWC, FXSB, FXSBSE, FXSE and FXSTD) and '87-'13 Touring and Trike models.



E. FORK SLIDER DRAIN SCREW KIT – CHROME

F. FRONT WHEEL SPACERS – CHROME

There's always more room for chrome with these highly-polished chrome wheel spacers. They are manufactured to the Original Equipment tolerances, so you get exact product fitment and quality.

41597-00 Straight. \$29.95

Fits '00-'05 FXDWG and '00-'06 FXST, FXSTB and FXSTD models. Also fits models equipped with Inverted Front Fork Kit and .75" Axle Kit P/N 42134-06 or Billet Fork Sliders P/N 46280-03. Does not fit '03-'04 FXSTDSE.



F. FRONT WHEEL SPACERS – CHROME

G. FRONT FENDER HARDWARE KIT – CHROME

Finish the show-winning look with brilliant chrome hardware. Manufactured to Original Equipment specifications, this kit replaces the zinc-plated exposed front fender mounting bolts with chrome-plated socket head cap screws.

94415-05 \$9.95

Fits '93-'05 FXDWG and '91-'17 Softail models (except Springer, FXCW, FXCWC, FXSB, FXSBSE, FXSE and FXSTD) models. Does not fit with Billet Fork Sliders or Inverted Front End Kit.



G. FRONT FENDER HARDWARE KIT – CHROME

Notice: The prices appearing in this catalog are the manufacturer's suggested retail prices. Actual retail prices may vary.



H. BRAKE CALIPER KIT – RED
(41300127 SHOWN)



H. BRAKE CALIPER KIT – RED
(41300157 SHOWN)



I. FRONT BRAKE CALIPER KIT – CHROME
(SHOWN WITH CHROME CALIPER BOLT COVER
KIT AND CALIPER INSERT)



J. REAR CALIPER BRACKET – CHROME



K. CUSTOM CALIPER BOLT COVER KIT
(40955-05 SHOWN)



L. BRAKE BLEEDER AND BANJO BOLT COVERS



M. BRAKE CALIPER INSERTS



N. BRAKE CALIPER TRIM DISCS

H. BRAKE CALIPER KIT – RED

41300127 Front & Rear Kit. **\$399.95**
Fits '08-'17 Dyna® (except FXDF, FXDLS and '14-'17 FXDL) and '08-'14 Softail® models (except Springer™) equipped with single disc front brakes. Kit includes one front and one rear caliper. Brake pads sold separately.

41300157 Rear. **\$299.95**
Fits '08-'17 Dyna and Softail models. Brake pads sold separately.

I. BRAKE CALIPER KIT – CHROME

44395-08 Front – Single Disc. **\$389.95**
Fits '08-'17 Dyna (except FXDF, FXDLS and '14-'17 FXDL) and '08-'14 Softail models (except Springer) equipped with single disc front brakes. Brake pads sold separately.

44395-00A Front – Single Disc. **\$389.95**
Fits '00-'03 XL, '00-'07 Dyna and '00-'07 Softail models (except Springer) equipped with single disc front brakes. Brake pads sold separately.

44392-00A Front – Dual Disc. **\$799.95**
Fits '02-'05 VRSC™, '00-'03 XL, '00-'07 Dyna and '00-'07 Touring models with dual disc front brakes. Brake pads sold separately.

42047-08 Rear. **\$349.95**
Fits '08-'17 Dyna and Softail models. Brake pads sold separately.

J. REAR BRAKE CALIPER BRACKET – CHROME

42002-08 Fits '08-'17 Dyna models. **\$129.95**

K. CUSTOM CALIPER BOLT COVER KIT

40955-05 Four Large and Two Small Covers. **\$28.95**
Fits '00-later front brake calipers (except Springer, '06-later VRSC, '04-later XL, '15-later XG, '16-'17 FXDLS, '18-later Softail, '08-later Touring and Trike models and models equipped with caliper covers). Also fits rear calipers on '06-'17 Softail models (except FXCW and FXSE).

43824-03 Four Large Covers. **\$23.95**
Fits '00-later front and rear 12-point caliper mounting bolts (except Springer front calipers, '06 VRSCR, '15-later XG and '08-later Touring and Trike models).

40959-05 Three Large and Two Small Covers. **\$23.95**
Fits '00-later rear brake calipers (except Springer, '06-later VRSC, '04-later XL, '15-later XG, '16-'17 FXDLS, '18-later Softail, '08-later Touring and Trike and models equipped with caliper covers). Also fits rear calipers on '06-'17 Softail models (except FXCW, FXSE).

L. BRAKE BLEEDER AND BANJO BOLT COVERS

1. Brake Bleeder Screw Cover
This cover adds chrome to the unfinished bleeder valve on stock H-D® calipers. Package of two.

43834-98 **\$23.95**
Fits '84-later stock calipers (except XG and XR models).

2. Chrome Banjo Bolt Cover
Die-cast chrome cover provides a custom look to your stock banjo bolts. Fits banjo bolts on front and rear brake master cylinders and front and rear calipers. Installs in seconds.

32715-98 **\$21.95**
Fits '84-later models with stock master cylinders and calipers. (Does not fit VRSC Rear Master Cylinder, '06-'17 VRSC calipers, '15-later XG, '04-later XL, or '08-later Dyna, Softail, Touring and Trike models).

M. BRAKE CALIPER INSERTS

Fits '00-later front and rear brake calipers on all models (except Springer front, '06-later VRSC, '15-later XG, '04-later XL, '18-later Softail rear caliper, and '08-later Touring and Trike).

1. 44477-99 Classic Chrome. **\$16.95**

2. 44476-99 Harley-Davidson Script. **\$16.95**

N. BRAKE CALIPER TRIM DISCS

Available in 1.375" and 1.75" diameters to accommodate front and rear calipers on most '99-earlier models and front calipers on '00-later Springer models. Easy to install.

1. 44095-96 H-D Motor Co. – 1.375" Diameter. **\$16.95**

44093-96 H-D Motor Co. – 1.75" Diameter. **\$16.95**

2. 99661-92T Gold Live to Ride – 1.375" Diameter. **\$16.95**

99663-92T Gold Live to Ride – 1.75" Diameter. **\$16.95**

140 DYNA®

Chassis Trim – Rear End

A. LOWER BELT GUARD COVER – CHROME

Designed to cover the Original Equipment black lower debris deflector, this mirror chrome finished cover adds an exceptional finish to the rear drive components. Kit includes required mounting hardware.

60514-07A Fits '07-'17 Dyna® models. **\$64.95**

Also available:

UPPER BELT GUARD – CHROME

Hand-polished and chrome-plated to replace your factory-equipped black upper belt guard.

60293-00 Fits '00-'05 Dyna models. **\$159.95**

B. HARLEY-DAVIDSON® SCRIPT REAR AXLE COVERS

Chrome-plated die-cast cover conceals the side of the swingarm and the axle. Unique styling features a black-filled embossed Harley-Davidson script for a distinctive contrast. The kit is easy to install without removing the rear wheel. Kit includes all necessary mounting hardware.

44346-06 **\$74.95**

Fits '06-'17 Dyna models. Will not fit models equipped with saddlebags.



A. LOWER BELT GUARD COVER – CHROME
(60514-07A SHOWN)



A. CHROME UPPER AND LOWER BELT GUARDS



B. HARLEY-DAVIDSON SCRIPT REAR AXLE COVERS

Notice: The prices appearing in this catalog are the manufacturer's suggested retail prices. Actual retail prices may vary.



C. DOMINION REAR AXLE NUT COVERS – GLOSS BLACK



C. DOMINION REAR AXLE NUT COVERS – BRONZE

REAR AXLE NUT COVERS

Cover your rear axle nut in the most traditional way. These Rear Axle Cover Kits complement the matching Front Axle Nut covers. Easy to install, these cover kits include necessary mounting hardware. Sold in pairs.

Fits '08-'17 Dyna® and '08-later Softail® models (except FXCW, FXCWC, FXSB, FXSBSE, FXSE, FXST-Aus, and '18-later FLFB, FLFBS, FLSB, FXBR, FXBRS and FXDRS).

C. DOMINION™ COLLECTION REAR AXLE NUT COVERS

Express your bold, renegade attitude. The machined aluminum Dominion™ Collection Rear Axle Nut Covers add style to the front of the bike and are the perfect complement to other Dominion Collection accessories.

43000129	Gloss Black.	\$74.95
43000128	Bronze.	\$74.95

D. CHROME REAR AXLE NUT COVERS

43132-08	Billet.	\$42.95
41705-09	Die-Cast.	\$29.95

E. GLOSS BLACK REAR AXLE NUT COVERS

43422-09	Billet.	\$42.95
-----------------	---------	----------------

F. SATIN CHROME REAR AXLE NUT COVERS

Cover your rear axle nut in the most traditional way. Finished in rich satin chrome, these easy to install rear axle covers are a subtle addition to blacked-out finishes. Kit includes necessary mounting hardware. Sold in pairs.

43000110		\$29.95
-----------------	--	----------------

G. BRASS COLLECTION REAR AXLE NUT COVERS

Cover your rear axle nut in the most traditional way. Artistically manufactured from solid brass, these components feature a natural antique finish that will age and patina when exposed to the elements. Brass Collection Rear Axle Nut Covers complement the matching Front Axle Nut covers. Easy to install kits include all necessary mounting hardware. Sold in pairs.

43000050		\$54.95
-----------------	--	----------------

H. WILLIE G SKULL REAR AXLE COVERS

Add a little attitude to your ride. Styled to complement Harley-Davidson® Skull accessory items, the menacing raised skull with black-filled eyes leaps from a field of chrome.

41706-09A		\$34.95
------------------	--	----------------

I. H-D MOTOR CO. REAR AXLE COVERS

Die-cast, chrome-plated covers feature the Harley-Davidson Motor Co. graphic in black. Includes set screws and Allen wrench for easy installation.

41704-09		\$31.95
-----------------	--	----------------



D. CHROME REAR AXLE NUT COVERS



E. GLOSS BLACK REAR AXLE NUT COVERS



F. SATIN CHROME REAR AXLE NUT COVERS



G. BRASS COLLECTION REAR AXLE NUT COVERS



H. WILLIE G SKULL COLLECTION REAR AXLE NUT COVERS



I. H-D MOTOR CO. LOGO REAR AXLE NUT COVERS

Notice: The prices appearing in this catalog are the manufacturer's suggested retail prices. Actual retail prices may vary.

142 DYNA®

Chassis Trim – Rear End

A. REAR FENDER SUPPORT COVER KIT – GLOSS BLACK

Manufactured from Original Equipment components to ensure superior fit and finish, the gloss black Fender Strut Covers conceal the cast fender struts and continue the dark look to the back of the bike. The ideal finishing touch for your blacked-out Fat Bob® model, these covers are the perfect complement to available gloss black Passenger Sissy Bars and Luggage Racks.

59473-09 **\$129.95**
Fits '08-'17 FXDF and '09-'10 FXDFSE models.



A. REAR FENDER SUPPORT COVER KIT – GLOSS BLACK

B. SHOCK BOLT COVERS

It's the details that complete the look of your bike. These Shock Bolt Covers are designed to hide the upper shock mounting hardware and provide a custom look to the rear of your bike. Easy-to-install, the kit includes left and right bolt covers and all required mounting hardware.

Fits '04-'16 XL and '06-'17 Dyna® models (except FLD, FXDF, FXDL and FXDLS). Does not fit with H-D® Detachables™ Leather Saddlebag Kit P/N 90181-08A.

54000016 Chrome. **\$39.95**
54000017 Gloss Black. **\$39.95**



B. SHOCK BOLT COVERS – CHROME



B. SHOCK BOLT COVERS – GLOSS BLACK

C. MAGNUM 5 SPROCKET COVER

Styled to match the distinctive Magnum 5 Custom Wheel. Available in mirror chrome or gloss black, this Sprocket Cover gives the appearance of having a custom sprocket at a fraction of the cost. Cover is easy to install with Original Equipment hardware or add the Chrome Hardware Kit P/N 94773-07 (sold separately) for a finished look.

Fits '07-'17 Dyna models (except FLD).

40120-09 Chrome. **\$64.95**



C. MAGNUM 5 SPROCKET COVER – CHROME



D. SPROCKET HARDWARE – CHROME HEX HEAD

D. SPROCKET HARDWARE – CHROME HEX HEAD

This kit includes highly-polished, chrome-plated, grade 8 hex-head screws with chrome-plated washers, providing an extra custom accent. The perfect addition to the new chrome sprocket. Made from the same Original Equipment bolts to ensure product integrity. Also works with chrome belt sprocket covers and Original Equipment sprockets.

94773-07 **\$29.95**
Fits '07-'17 Dyna and Softail® models.

94773-00A **\$29.95**
Fits '00-'05 Dyna and '00-'06 Softail models.

94708-98 **\$29.95**
Fits '91-later XL and '93-'99 Dyna and Softail models.

E. SIDE-MOUNT LICENSE PLATE KIT

Add a clean, custom look to the rear fender. This stylish kit moves the license plate from the fender to a side-mount location, visually lowering the bike's profile and opening up the view of the rear end. This strut-mounted hinged frame conceals the license mounting hardware and features a smooth back that hides the unfinished side of the plate. Kit includes LED license plate illumination and a curved Bar & Shield medallion, shaped to conceal the original license mounting holes in the fender. Purchase of tail lamp without license illumination window is recommended for models with center-mounted tail lights.

NOTE: License plate location and fold-away feature is regulated in many states. Check state and local laws before installation.

Fits '06-'17 Dyna models (except FLD, FXDF, FXDWG and FXDFSE). Will not fit models equipped with rigid mount saddlebags, rigid mount sissy bars and Turn Signal Relocation Kit P/N 68732-02A and 68733-02A.

60938-10 Chrome. **\$199.95**
60978-10 Gloss Black. **\$199.95**



E. SIDE-MOUNT LICENSE PLATE KIT – CHROME



E. SIDE-MOUNT LICENSE PLATE KIT – GLOSS BLACK

Notice: The prices appearing in this catalog are the manufacturer's suggested retail prices. Actual retail prices may vary.

DYNA® 143

Chassis Trim



F. BATTERY & ELECTRICAL PANEL COVER KIT – CHROME



F. BATTERY & ELECTRICAL PANEL COVER KIT – CHROME

Dress your bike with a new chrome skin. This two-piece kit replaces the painted battery and electrical panel covers and adds a bright contrast to the motorcycle's profile. Add your choice of accessory Battery Cover Band Trim (sold separately) for a finishing touch.

61300186 **\$159.95**
Fits '12-'17 Dyna® models.

G. BATTERY COVER – CHROME

Dress your battery with a new chrome skin. This one-piece Chrome Battery Cover replaces the painted box and adds a bright contrast to the Original Equipment satin aluminum trim band.

66375-06 **\$79.95**
Fits '06-'17 Dyna models (except FXDL). '14-'17 Dyna models require purchase of a battery cover trim band.



G. BATTERY COVER – CHROME



H. BATTERY COVER BAND – CHROME

H. BATTERY COVER BAND – CHROME

This sweeping chrome band replaces the Original Equipment satin-finish band for a mirror-polished look. The easy-to-install ribbed chrome band is a high-contrast addition to a painted battery cover or the perfect finishing touch to the Chrome Battery Cover P/N 66375-06.

66439-07 **\$33.95**
Fits '06-'17 Dyna models (except FLD, FXDL, '13-'17 FXDB and '14-'17 FXDF). Also fits models equipped with Battery and Electrical Panel Cover Kit P/N 61300186.

I. BATTERY COVER BAND – HARLEY-DAVIDSON® SCRIPT

Replace the Original Equipment satin aluminum trim band with a splash of chrome. This easy-to-install custom contoured trim band features a black-filled embossed Harley-Davidson script design and offers a stunning contrast to the factory painted battery cover or a great finishing touch for the Chrome Battery Cover P/N 66375-06 or 61300186.

66443-06 **\$39.95**
Fits '06-'17 Dyna models (except FLD, FXDL, '13-'17 FXDB and '14-'17 FXDF). Also fits models equipped with Battery and Electrical Panel Cover Kit P/N 61300186.



I. BATTERY COVER BAND – HARLEY-DAVIDSON SCRIPT



J. ELECTRICAL PANEL TRIM – CHROME

J. ELECTRICAL PANEL TRIM – CHROME

This sweeping chrome spear adds a mirror-polished accent to your bike's profile. The easy-to-install band is a high-contrast addition to the Original Equipment painted electrical panel cover or the perfect finishing touch on a Chrome Cover.

66462-07 **\$44.95**
Fits '04-'17 Dyna models (except '06 FXD35, '04-'13 FXDL, '17-later FXDLS and '04-'08 FXDWG models with Original Equipment electrical panel cover).

K. ELECTRICAL PANEL COVER WITH TRIM – CHROME

Chrome-plated Electrical Panel Cover with concealed mounting hardware provides a nice clean look. Kit includes panel cover, distinctive chrome-plated die-cast trim with black accented lines and Bar & Shield logo and all necessary mounting hardware.

66426-04 **\$84.95**
Fits '04-'11 Dyna models.



K. ELECTRICAL PANEL COVER WITH TRIM – CHROME



DYNA

Notice: The prices appearing in this catalog are the manufacturer's suggested retail prices. Actual retail prices may vary.

144 DYNA®

Chassis Trim

A. BATTERY SIDE COVER – CHROME*

This chrome-plated cover is designed for use with the new Harley-Davidson® AGM sealed maintenance-free batteries and can be used in combination with Battery Top Cover P/N 66367-97 or 66368-97.

66718-01 **\$49.95**
Fits '97-'03 XL and '97-'05 Dyna® models.



A. BATTERY SIDE COVER – CHROME

B. BATTERY COVERS – CHROME*

Chrome-plated battery enclosures include slotted openings for convenient visual check of battery fluid levels. Easy installation.

66375-97 **\$64.95**
Fits '97-'05, '97-'05 FXD, '99-'05 FXDX and '01-'03 FXDXT models. Stock on FXDL, FXDWG and FXDS-CONV. models.



B. BATTERY COVERS – CHROME

C. BATTERY TOP COVER – CHROME

Turn black to chrome with this easy-to-install cover.

66368-97 Fits '97-'05 Dyna models. **\$59.95**



C. BATTERY TOP COVER – CHROME

D. COIL COVER – CHROME

This sleek, Chrome Coil Cover features an innovative design that conceals all the mounting hardware. It offers a great, easy way to customize a very visible part of your Dyna motorcycles.

31709-04 **\$39.95**
Fits '04-'17 fuel-injected Dyna models.



D. COIL COVER – CHROME

E. BAR & SHIELD LOGO COIL COVER

Featuring a radical open-face design with a Bar & Shield silhouette, this Chrome Coil Cover matches the Chrome Voltage Regulator Cover for an integrated custom look. Includes all mounting hardware.

74616-04 **\$39.95**
Fits '04-'17 EFI Dyna and '01-'17 EFI equipped Softail® models (except FXCW, FXCWC, FXS, FXSB, FXSBSE, FXSE and FXST-Aus).

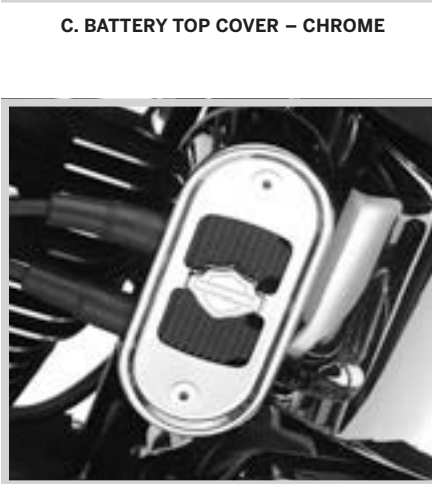

E. BAR & SHIELD LOGO COIL COVER

F. VOLTAGE REGULATOR COVER

Designed for up-front style, the open face and floating Bar & Shield logo on this chrome cover provide good looks without compromising air flow across the voltage regulator. Kit includes chrome-plated mounting hardware.

74667-06 Fits '06-'11 Dyna models. **\$44.95**



F. VOLTAGE REGULATOR COVER

G. PREMIUM OIL COOLER KITS

This oil cooler was designed specifically for Harley-Davidson to out-perform all other coolers in the industry. The cooler features a unique Turbulator system that evenly distributes oil across the cooling chambers. The air fins are designed to efficiently dissipate heat. The oil cooler has been designed to simplify installation and enhance performance. The large heat exchanger provides excellent cooling efficiency. The kit features a one-piece adapter plate with integrated thermostat that allows oil lines to connect to the oil filter bracket. Thermostat activates at 185°F (85°C). Kit comes complete with mounting hardware and pre-cut oil lines.

26151-07B Horizontal Mount. **\$399.95**
Fits '06-'17 Dyna models (except FLD, FXDSE, FXDFSE, FXDLS and California models). Does not fit with Front Spoiler Kits or DEFINITIVE5™ Filtration System Kits. Fits with all H-D® Engine Guards. Includes chrome oil cooler cover.

62700017A Side Mount. **\$379.95**
Fits '07-'17 Dyna models (except FXDLS). Fits with all H-D® Engine Guards. Includes gloss black Oil Cooler Cover.

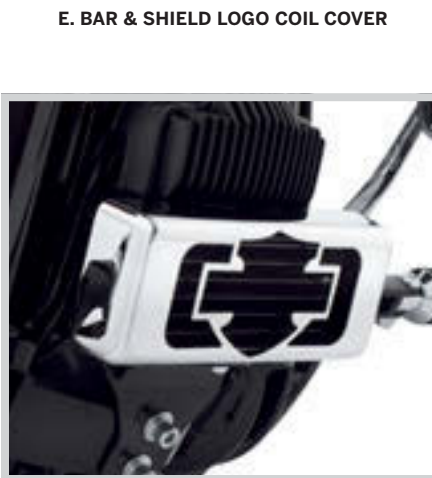

G. PREMIUM OIL COOLER KIT – DYNA HORIZONTAL MOUNT

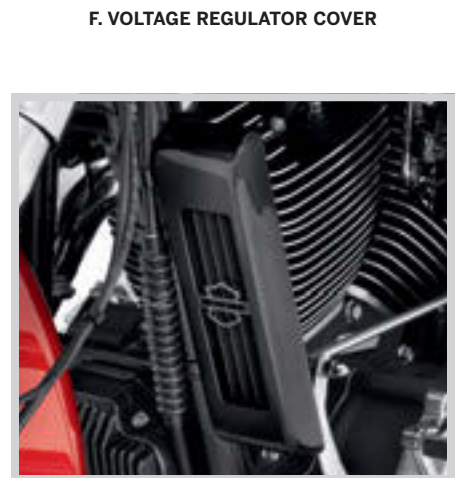

G. PREMIUM OIL COOLER KIT – DYNA SIDE MOUNT

*NOTE: Battery dimensions of Harley-Davidson AGM Batteries P/N 65989-97A, 65989-90B and 65991-82B may not allow use of accessory battery side covers on XL and Dyna models.

Notice: The prices appearing in this catalog are the manufacturer's suggested retail prices. Actual retail prices may vary.

DYNA® 145

Chassis Trim



H. TANK BRA



I. PREMIUM TANK PANEL WITH POUCH

H. TANK BRA

This Tank Bra is made with nonabrasive, fleece-backed vinyl material and features an embroidered Bar & Shield logo. It protects your fuel tank from scratches from keys, belt buckles and other objects. Designed for easy installation and a custom fit without disassembly of the tank or seat.

62028-04 **\$42.95**
Fits '04-'17 Dyna® models.

57799-00 **\$43.95**
Fits '93-'03 FXDWG and '00-'17 Softtail® models (except FXCW, FXCWC, FXS, FXSB, FXSE, FXSTD, FXSTSE, FXSTSSE, '09-'17 FLS, FLSS, FLSTC, FLSTSB and FLSTSE and '06 FLSTFSE).

I. PREMIUM TANK PANEL WITH POUCH

This leather tank panel features an over-sized pouch for convenient at your fingertips storage. The heavy-duty leather pouch will maintain its shape for miles to come while the bold chrome Bar & Shield medallion sits proudly on the flap for all to admire.

91135-09 **\$99.95**
Fits '93-'08 FXDWG, '06 FXD35, '07-'17 FXDC and FXDF and '00-'17 Softtail models (except FLS, FLSS, FLSTNSE, FLSTSB, FLSTSE, FXCW, FXCWC, FXS, FXSB, FXSBSE, FXSE, FXSTD, FXSTSSE, '09-'17 FLSTC and '06 FLSTFSE). '93-'03 FXDWG models require the separate purchase of Clip P/N 10102 and O-Ring P/N 11174.

J. DASH PANEL EXTENSION – CHROME

Stretch the lines of your chrome dash panel the full length of the fuel tank. This chrome-plated trim kit continues the lines and finishes of your standard tank panel to the front of the seat. The curving lines and Bar & Shield logo add a custom touch without the expense of a custom tank.

71282-04 **\$42.95**
Fits '06 FXD35, '07-'11 FXDC, '08-'10 FXDF and '04-'08 FXDWG models.

K. FRONT FENDER EXTENSION – CHROME

Dress your front fender in chrome. This chrome-plated tapered Fender Extension is shaped to follow the curve of the fender for style and function. Using the Original Equipment fender hole, the extension mounts below the trailing edge of the fender to help control road dirt and spray.

59664-03 **\$49.95**
Fits '91-'08 Dyna and '84-'07 FX Softtail models. Will not fit FXD, FXDX or FXDXT models equipped with Voltage Regulator Covers.

L. FRONT FENDER TRIM

Add a sweeping dash of chrome to the front fender. Chrome-plated tapered spear features a stepped design that accentuates the flowing fender lines. Self-adhesive backing simplifies installation.

14100618 **\$44.95**
Fits FLD, FL Softail and Touring and Trike models with full front fender.

M. BAR & SHIELD LOGO FRONT FENDER SPEAR

This chrome-plated trim spear adds a sweeping dash of chrome to the front fender. Featuring a raised Bar & Shield logo set against a textured black field, this self-adhesive medallion is easy to install.

91194-04 Small **\$39.95**
Fits XL, XR, Dyna (except FLD), FX Softtail (except FXFB) and '18-later FLSS models.



J. DASH PANEL EXTENSION – CHROME



K. FRONT FENDER EXTENSION – CHROME



L. FRONT FENDER TRIM



M. BAR & SHIELD LOGO FRONT FENDER SPEAR

DYNA

Notice: The prices appearing in this catalog are the manufacturer's suggested retail prices. Actual retail prices may vary.



FXDR™ 114

MILWAUKEE-EIGHT® SOFTAIL® | FXDRS | VIVID BLACK

Leave it all behind in a massive cloud of dust. With its ported heads, blacked-out grips, mirrors, and a voracious Milwaukee-Eight® engine, those objects in your rearview mirror won't be closer than they appear — they'll be much, much farther.



Screamin' Eagle® Muffler & Header Shield p 454



Dominion™ Derby Cover (Black/Orange)..... p 528

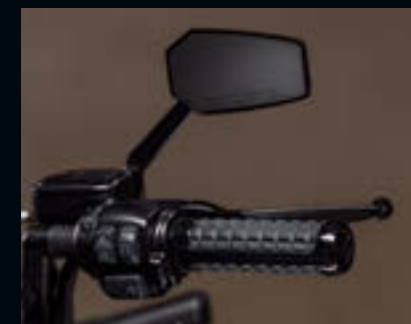

Dominion™ Hand Grips/Mirrors (Black) p 580 & 619



Screamin' Eagle® Timer Cover Base & Stage IV 117 Insert... p 465



STREET BOB®

MILWAUKEE-EIGHT® SOFTAIL® | FXBB | COLOR SHOP LIMITED SERIES: TAGGED

It's as urban as steaming blacktop and metal fire escapes. Tagged with graffiti and trimmed with blacked-out covers and controls, this Street Bob® motorcycle is the newly crowned king of the urban jungle.



Limited Paint (Tagged)..... p.786



Dominion™ Derby Cover (Black/Orange)..... p.528



Dominion™ Engine Trim (Black/Orange) p.528



Dominion™ Rider Footpeg/Shifter Peg (Black)..... p.580



LOW RIDER®

MILWAUKEE-EIGHT® SOFTAIL® | FXLR | BARRACUDA SILVER

What's on the lunch menu today? Miles of open road with a side of style. With an ultra-comfortable seat, detachable saddlebags and machine-cut accents, this is one Softail® motorcycle that's always hungry and ready to eat mile after mile.



Sundowner™ Seat..... p179



Black Standard Line Tool Bag..... p776



H-D® Detachables™ Saddlebag..... p192



Diamond Black Fuel Cap..... p702



*Handlebar height is regulated in many locations. Check local laws before installation.

SOFTAIL SLIM®

MILWAUKEE-EIGHT® SOFTAIL® | FLSL | WICKED RED DENIM

The poster child for rebellion. Stripped down to the bare essentials with chizeled handlebars, a solo saddle, old-school whitewall tires and a powerful Milwaukee-Eight® engine for that classic bobber look that continues to break all the rules.



Tuck & Roll Solo Saddle..... p.182



Fat Chizeled Handlebarp.637



16" Dunlop® Front Tire (Whitewall) p.852



Brass Collection Fuel Caps..... p.702



FAT BOB®

MILWAUKEE-EIGHT® SOFTAIL® | FXFB | VIVID BLACK

This is one bike that needs no introduction. From its bronze accents to its aggressive, battle-hardened styling and high-flow air cleaner, the Fat Bob® knows how to make an entrance and leave a lasting impression.



FXFB Header Mid-Shield (Black)..... p455



Screamin' Eagle® Heavy Breather Air Cleaner..... p445



Dominion™ Footpeg (Bronze)..... p581



Dominion™ Hand Grips/Mirrors (Bronze)p581&619



*Handlebar height is regulated in many locations. Check local laws before installation.

DELUXE

MILWAUKEE-EIGHT® SOFTAIL® | FLDE | MIDNIGHT BLUE & BARRACUDA SILVER

It can turn corners as easily as it turns heads. Because when you're rocking axle-to-axle chrome from the chizeled handlebars and controls down to the oil cooler cover, clutch bracket and footboards, heads won't just turn — they'll spin.



Fat Chizeled Handlebar p.637



Oil Cooler Cover (Chrome) p.205



Defiance Footboards (Chrome) p.590



Chrome Clutch Bracket & Master Cylinder Reservoir Kit .. p.623



SPORT GLIDE®

MILWAUKEE-EIGHT® SOFTAIL® | FLSB | BARRACUDA SILVER

It's the literal definition of performance art. Stripped down. Blacked out. And ready to take on the open road with its Edge Cut controls, rumbling exhaust note, black anodized accents and a powerful Milwaukee-Eight® engine that performs like a true work of art.



Hand Control Levers — Edge Cut p622



Rear Turn Signals (Black)..... p735



Screamin' Eagle® Timer Cover Base & Stage I 107 Insert.....p465



Anodized Slotted Rear Shift Linkage (Black) p201



FAT BOY®

MILWAUKEE-EIGHT® SOFTAIL® | FLFB | RAWHIDE

Calling it burly would be the understatement of the year. And once you throw a leg over its solo seat and grab a handful of its rubber studded grips, you'll quickly come to realize that you don't call this Fat Boy® motorcycle anything less than perfect.



Street Slammer Handlebar & Dominion™ Hand Grips...p 634 & 580



Brawler® Solo Seat..... p173



Chassis Trim — Front End (Gloss Black) p204



Profile Custom Mirrors With Slotted Stem p620



*Some local regulations prohibit using colored or indirect lighting during vehicle operation on public streets. Check local regulations before installation.

BREAKOUT®

MILWAUKEE-EIGHT® SOFTAIL® | FXBR | COLOR SHOP LIMITED SERIES: LA JOLLA

If you thought you've seen it all, we can assure you — you haven't. From its tank art that goes above and beyond the ordinary to its Spectra Glo™ lighting and black-as-night accents, this is one Breakout® model that'll make an impact everywhere it goes.



Dominion™ Primary Cover (Black/Orange)..... p531



Spectra Glo™ LED Lighting..... p710



Gear Shift Linkage (Black) & Dominion™ Foot Controls..... p580



Dominion™ Engine Trim (Black/Orange)..... p528



HERITAGE CLASSIC

MILWAUKEE-EIGHT® SOFTAIL® | FLHCS | RAWHIDE & VIVID BLACK

One part throwback. Two parts throwdown. From its contrasting finishes and thunderous exhaust note, this Heritage Classic (114 cu. in.) is the modern-day outlaw that's always ready to take on anything that steps in its path.



Dominion™ Upper Rocker Box Cover (Bronze/Black) p529



Dominion™ Derby Cover (Bronze/Black)..... p529



Dominion™ Hand Grip/Mirror (Bronze)..... p581 & 619

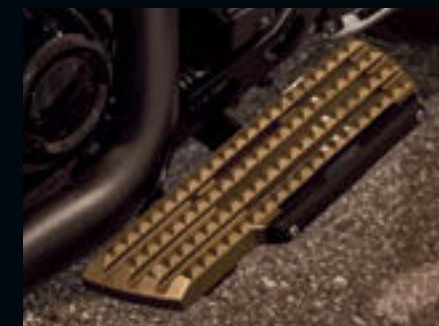

Dominion™ Rider Footboard (Bronze/Black) p581

DEFY THE WIND

At highway speed, you take the wind full-force in the chest, causing fatigue in your arms, neck and shoulders.

Take the pressure off with an easy-to-install detachable windshield.

Shaped to divert air, rain and road debris around the rider, a windshield can add hours of riding comfort.

KEEPING YOU COVERED

17.5 IN

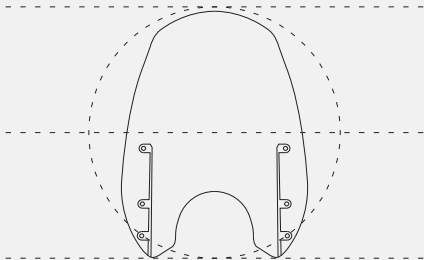

SUPER SPORT

Eliminates wind and debris, but keeps the wind-in-the-hair feeling. Ideal for a cool morning ride to the office, the sleek profile hugs the front lamps for a sporty look.

18.2 IN

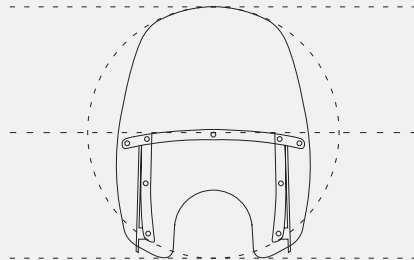

COMPACT

Traditional king-sized shape with a minimalist edge. For Harley-Davidson® custom and cruiser models, the Compact windshield provides wind and weather protection for every-day riding.

21.5 IN

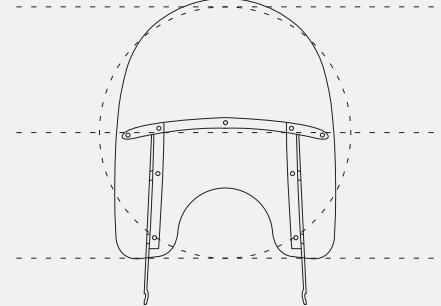

KING SIZE

Nothing gets past this one. The King Size windshield is the ultimate in on-road protection. Available in a variety of shield heights, the road can't lay a finger on you.

READY FOR TAKE-OFF

Designed to be installed or removed without tools in seconds, a detachable windshield gives you the freedom to define your ride at the drop of a hat. Ride across the country protected from the elements, then quickly remove the windshield to hit the streets in style.



To avoid looking through bug spots, condensation and road grime, select a windshield that tops out just below your line of sight.

WIND SPLITTER FLIP

Shaped for effective airflow management, Wind Splitter windshields feature a "flip" at the upper edge to help reduce helmet buffeting at speed.

SCRATCH-RESISTANT HARD-COATED POLYCARBONATE SHIELD

STAINLESS STEEL BRACKETS & BRACES

NO TOOLS QUICK-RELEASE MOUNT

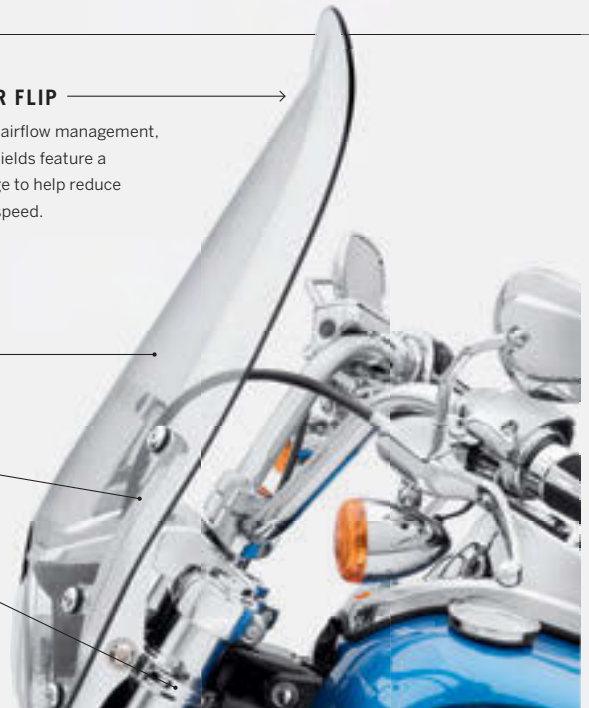

MILWAUKEE-EIGHT® SOFTAIL® 167

Windshields – Super Sport



**A. WIND SPLITTER QUICK-RELEASE SUPER SPORT WINDSHIELD
(57400323 SHOWN)**

A. WIND SPLITTER QUICK-RELEASE SUPER SPORT WINDSHIELD

Shaped with just the right mix of width and height to reduce the pounding air pressure against your chest, the Wind Splitter Super Sport Windshield allows you ride comfortably while maintaining the wind-in-the-hair feeling. The windshield's contoured design incorporates a flipped upper edge that manages airflow and turbulence across the top of the shield. The flip adds additional wind shear lift, and effectively provides the protection of a taller wind screen. Ideal for a cool morning ride, the sleek profile of the Super Sport Windshield hugs the front headlamp for a sporty look. And because the windshield mounts to the fork tubes with elegant die-cast lever-locking clamps, you get quick on-and-off convenience and a clean, custom look. Kit includes the hard-coated polycarbonate screen, brackets and quick-release docking clamps.

57400323 19" Light Smoke – Polished. **\$369.95**

Fits '18-later FXBB, FXLR and '14-'17 FXDL models.

Windshield dimensions: Overall height – 24.4"; width – 17.5".

57400334 19" Light Smoke – Polished. **\$369.95**

Fits '18-later FXBR and FXBRS models. Windshield

dimensions: Overall height – 24.4"; width – 17.5".

B. QUICK-RELEASE SUPER SPORT WINDSHIELD

Reduces the pounding of wind and shower of bugs, but keeps the wind-in-the-hair feeling. Ideal for a cool morning ride, the sleek profile of the Super Sport Windshield hugs the front headlamp for a sporty look. The windshield mounts to the fork tubes with elegant die-cast lever locking clamps, so the windshield does not require any "leave-behind" docking hardware. You get quick on-and-off convenience and a clean, custom look. No tools are required and the kit includes everything needed to install the windshield.

57300-06 19" Light Smoke. **\$349.95**

Fits '06-'17 Dyna® (except FLD, FXDWG, FXDF and FXDSE)

and '18-later Softail® FXBB and FXLR models. FXDLS models

require the removal of Original Equipment Wind Deflector.

Windshield dimensions: Overall height – 25.0"; width – 20.1".

57301-06 19" Light Smoke. **\$349.95**

Fits '06-'17 FXDWG, '13-'17 FXSB and FXSBSE and '18-later

FXBR and FXBRS models. Windshield dimensions: Overall

height – 25.0"; width – 20.1".



**B. QUICK-RELEASE SUPER SPORT WINDSHIELD
(57300-06 SHOWN)**

Notice: The prices appearing in this catalog are the manufacturer's suggested retail prices. Actual retail prices may vary.

168 MILWAUKEE-EIGHT® SOFTAIL®

Windshields – Compact

A. WIND SPLITTER QUICK-RELEASE COMPACT WINDSHIELD

Engineered to provide the riding comfort of a larger windshield, this Wind Splitter Windshield features a contemporary contour that sets it apart from the crowd. The compact shape is designed to keep the windshield below your line of sight so you don't need to look through bugs and road grime, while the flipped upper edge manages airflow and turbulence across the top of the shield. The flip adds additional wind shear lift to provide the protection of a taller wind screen. You get a fatigue-free highway ride with reduced pressure on your chest and arms, and the detachable design means you can ride without the shield when the mood strikes. The hard-coated polycarbonate windshield mounts to the fork tubes with elegant die-cast lever-release clamps, so the windshield does not require any leave-behind hardware. You get quick on-and-off convenience and a clean, custom look. No tools are required and the kit includes everything needed to install the windshield.

Fits '18-later FXBB, FXLR and '14-'17 FXDL models.

57400327 18" Clear – Polished. **\$394.95**

Windshield dimensions: Overall height – 23.4"; width – 17.6".

57400337 18" Light Smoke – Polished. **\$444.95**

Windshield dimensions: Overall height – 23.4"; width – 17.6".

57400331 14" Light Smoke – Polished. **\$424.95**

Windshield dimensions: Overall height – 19.5"; width – 17.6".

Fits '18-later FXBR and FXBRS models.

57400326 18" Clear – Polished. **\$394.95**

Windshield dimensions: Overall height – 23.4"; width – 17.6".

57400333 18" Light Smoke – Polished. **\$444.95**

Windshield dimensions: Overall height – 23.4"; width – 17.6".

57400336 14" Light Smoke – Polished. **\$424.95**

Windshield dimensions: Overall height – 19.5"; width – 17.6".

B. QUICK-RELEASE COMPACT WINDSHIELD

This tough, hard-coated polycarbonate Windshield wraps around the headlamp to offer the maximum wind protection available in a compact profile. The windshield mounts to the fork tubes with diecast lever-release clamps so the windshield does not require any leave-behind hardware. You get quick on-and-off convenience and a clean, custom look. No tools are required.

Fits '19-later FXDRS models. Windshield dimensions: Overall height – 16"; width – 15".

57400361 16" Light Smoke. **\$444.95**

Fits '06-'17 Dyna® (except FLD, FXDWG, FXDF and FXDSE) and '18-later Softail® FXBB and FXLR models. FXDLS models require the removal of Original Equipment Wind Deflector.

58346-06 18" Clear – Polished. **\$374.95**

Windshield dimensions: Overall height – 26.8"; width – 19.7".

58348-06 14" Light Smoke – Polished. **\$379.95**

Windshield dimensions: Overall height – 22.8"; width – 19.5".

Fits '06-'17 FXDWG, '13-'17 FXSB and FXSBSE and '18-later FXBR and FXBRS models

58387-06 18" Clear – Polished. **\$369.95**

Windshield dimensions: Overall height – 26.8"; width – 19.5".

58444-06 14" Light Smoke – Polished. **\$374.95**

Windshield dimensions: Overall height – 22.8"; width – 19.5".



**A. WIND SPLITTER QUICK-RELEASE COMPACT WINDSHIELD
(57400327 SHOWN)**



**B. QUICK RELEASE COMPACT WINDSHIELD
(57400361 SHOWN)**

Notice: The prices appearing in this catalog are the manufacturer's suggested retail prices. Actual retail prices may vary.

MILWAUKEE-EIGHT® SOFTAIL® 169

Windshields – Compact

C. WIND SPLITTER DETACHABLE COMPACT WINDSHIELD

Shaped to divert headwinds around the rider, this compact windshield moderates the air pressure against your chest and reduces the strain on your arms during a long highway ride. Designed to provide the riding comfort of a larger windshield, this Wind Splitter Windshield features flipped upper edge to manage the airflow and turbulence across the top of the shield. The flip adds additional wind shear lift to provide the protection of a taller wind screen. The compact size is the perfect compromise between function and style on the road, and the detachable design means you can ride without the shield when you prefer a wind-in-the-hair experience. The hard-coated polycarbonate windshield mounts to the fork triple trees with rubber isolators to reduce vibration and to provide quick tool-free on-and-off installation. Kit includes all mounting hardware.

Fits '18-later FLFB and FLFB models.

57400368 19" Clear – Polished. **\$414.95**

Windshield dimensions: Overall height – 23.2"; width – 18.9".

57400367 15" Light Smoke – Polished. **\$419.95**

Windshield dimensions: Overall height – 17.8"; width – 18.5".

Fits '18-later FXFB, FXFBS and '08-'17 FXDF models.

57400324 19" Clear – Black. **\$414.95**

Windshield dimensions: Overall height – 23.2"; width – 18.9".

57400330 15" Light Smoke – Black. **\$419.95**

Windshield dimensions: Overall height – 17.8"; width – 18.5".



C. WIND SPLITTER DETACHABLE COMPACT WINDSHIELD
(57400368 SHOWN)



C. WIND SPLITTER DETACHABLE COMPACT WINDSHIELD
(57400324 SHOWN)

SOFTAIL

Notice: The prices appearing in this catalog are the manufacturer's suggested retail prices. Actual retail prices may vary.

170 MILWAUKEE-EIGHT® SOFTAIL®

Windshields – King Size

A. KING-SIZE H-D® DETACHABLES™ WINDSHIELD

Nothing gets past this one. The King Size windshield is the ultimate in on-road protection. This full coverage shield creates a clean managed flow of air over and around the rider and passenger, and because it is designed to be installed or removed in seconds without tools, a detachable windshield gives you the freedom to define your ride at the drop of a hat. Ride across the country protected from the elements, then quickly remove the windshield to hit the streets in style. This one-piece windshield is formed from hard-coated polycarbonate material to resist scratching. The shield is attached to stainless steel mounting brackets supported by molded-rubber bushings for improved isolation. Windshields are available in a variety of heights to match your size, and with traditional polished or contemporary gloss black braces to match your bike's finishes. Kit includes mounting hardware.

Fits '18-later FLDE, FLHC and FLHCS models.

57400328 21" Clear – Polished. **\$389.95**
Windshield dimensions: Overall height – 26.8"; width – 21.4".

57400332 18" Clear – Polished. **\$374.95**
Windshield dimensions: Overall height – 23.8"; width – 21.5".

57400325 18" Clear – Black. **\$394.95**
Windshield dimensions: Overall height – 23.8"; width – 21.5".

B. KING-SIZE H-D DETACHABLES WINDSHIELD

Nothing gets past this one. The King Size windshield is the ultimate in on-road protection. This full coverage shield creates a clean managed flow of air over and around the rider and passenger, and because it is designed to be installed or removed in seconds without tools, a detachable windshield gives you the freedom to define your ride at the drop of a hat. Ride across the country protected from the elements, then quickly remove the windshield to hit the streets in style. This one-piece windshield is formed from hard-coated polycarbonate material to resist scratching. The shield is attached to stainless steel mounting brackets supported by molded-rubber bushings for improved isolation. Windshields are available in a variety of heights to match your size, and with contemporary gloss black braces. Kit includes mounting hardware.

Fits '18-later FLSL models.

57400369 21" Clear – Black. **\$409.95**
Windshield dimensions: Overall height – 28.6"; width – 21.4".

57400335 18" Clear – Black. **\$394.95**
Windshield dimensions: Overall height – 23.8"; width – 21.5".



**A. KING-SIZE H-D DETACHABLES WINDSHIELD
(DELUXE MODEL SHOWN)**



**B. KING-SIZE H-D DETACHABLES WINDSHIELD
(SLIM MODEL SHOWN)**

Notice: The prices appearing in this catalog are the manufacturer's suggested retail prices. Actual retail prices may vary.

MILWAUKEE-EIGHT® SOFTAIL® 171

Windshields

C. KING-SIZE NOSTALGIC H-D® DETACHABLES™ WINDSHIELD

A windshield provides a barrier between the rider and errant bugs, discarded cigarette butts, flying debris and bad air. The shield manages airflow and wind blasts to create a pocket of still air for both rider and passenger comfort. But it's not just about function. This one-piece windshield features a nostalgic horseshoe-shaped outer brace that is the perfect match for your classic Harley-Davidson® motorcycle. Formed from hard-coated polycarbonate to resist scratching, this tall windshield provides maximum protection on the highway, but when you want to ride "naked," the detachable shield can be removed completely or reinstalled in seconds to match your riding mood. Kit includes mounting hardware.

57400329 21" Clear – Polished. **\$399.95**
Fits '18-later FLDE, FLHC and FLHCS models. Windshield dimensions: Overall height – 27.0"; width – 21.5".

D. SPORT GLIDE® WINDSHIELD

Style meets function. This 5.5" tall Windshield stands 4" taller than the Original Equipment Sport Glide wind deflector to offer sport styling with a little greater wind protection. The taller shield moves more air up and over the rider to reduce helmet buffeting and wind-related fatigue. Harley-Davidson windshields are formed of hard-coated polycarbonate for strength and scratch resistance and the light smoke tint complements any paint color.

57400360 5.5" Light Smoke. **\$154.95**
Fits '18-later FL5B models.



C. KING-SIZE NOSTALGIC H-D DETACHABLES WINDSHIELD
(DELUXE MODEL SHOWN)

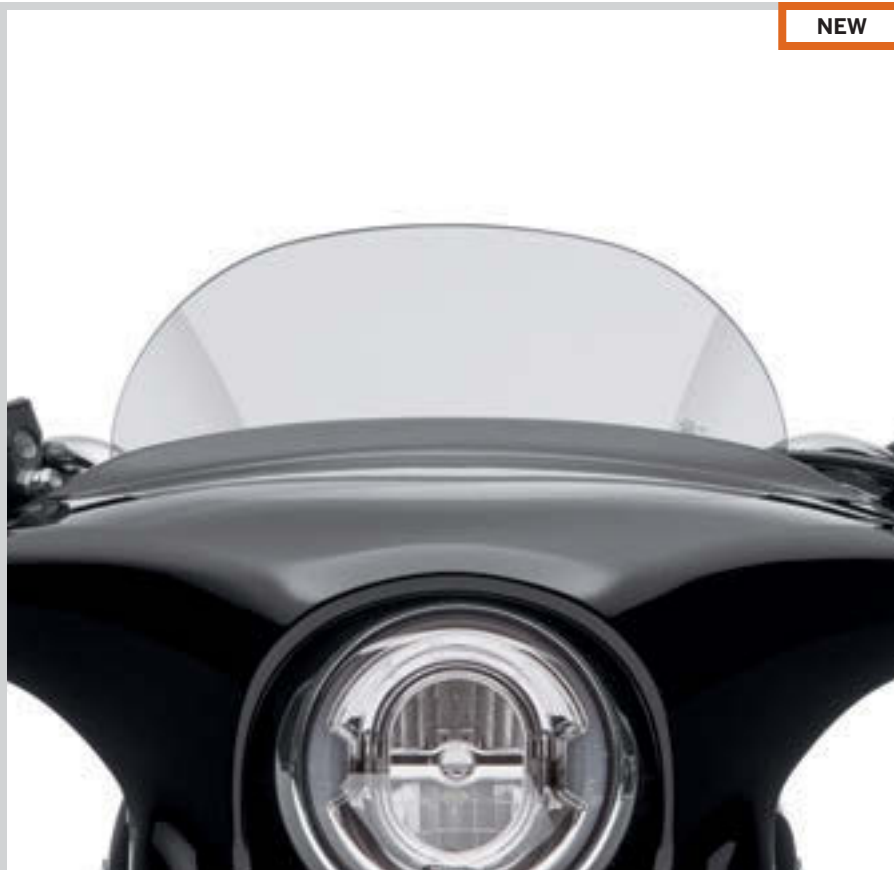

D. SPORT GLIDE WINDSHIELD

SOFTAIL

Notice: The prices appearing in this catalog are the manufacturer's suggested retail prices. Actual retail prices may vary.

ENJOY THE RIDE

The relationship between the seat, the handlebar and the foot controls has an enormous impact on the comfort, control, and confidence you feel when riding your motorcycle. Once you've picked the bike, it's time to choose the options that match your ride to your personal dimensions.



For shorter riders, consider tailoring your fit by changing to a Reach® Seat, Mid-Foot Controls, and lowered suspension height.



For taller riders, consider altering your ride by changing to a Tallboy® Seat and Extended Foot Controls.

ESTABLISH YOUR POSITION AND FEEL

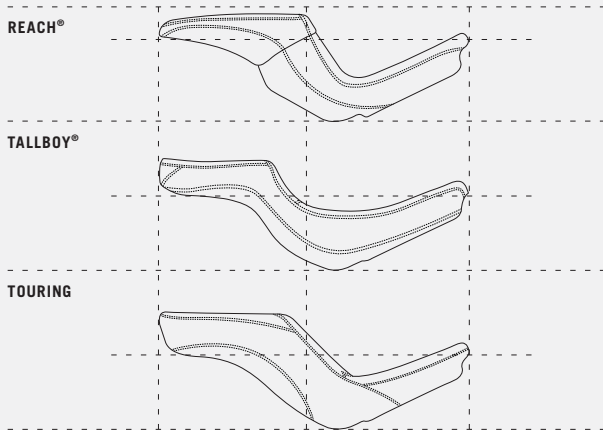

SEATS

Seat height and shape impact rider comfort, fit and confidence. Where the seat positions you relative to the foot controls, hand controls and the ground plays a major role in the quality of your ride.

SEE PAGES 173-180

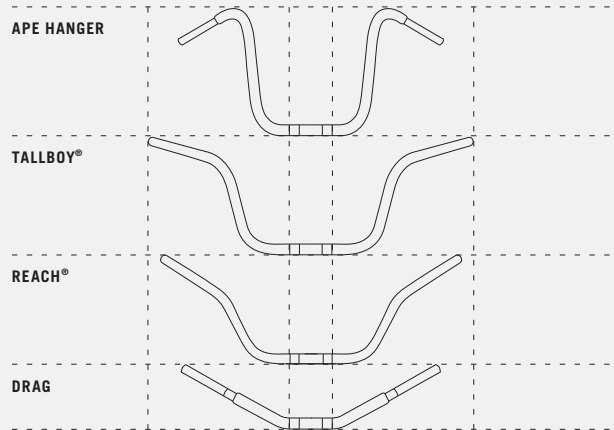

HANDLEBARS

Where the bar positions your arms, hands and wrists directly impacts how you feel on the motorcycle. Choose a bar that falls easily to hand, and does not pull you out of the seat when maneuvering.

SEE PAGES 632-641

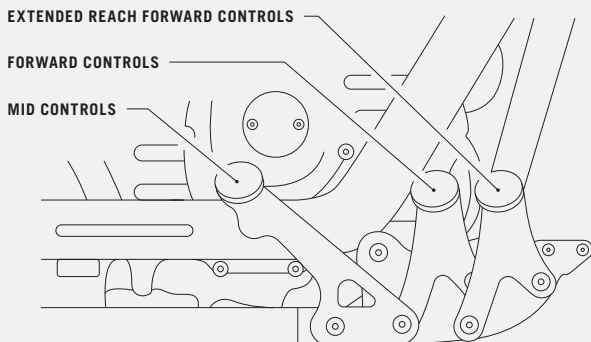

FOOT CONTROLS

Repositioning your feet can relieve muscle tension, take pressure off the tailbone and reduce fatigue. The correct riding position can add hours of comfort and hundreds of miles to your daily saddle time.

SEE PAGES 199-202, 580-613

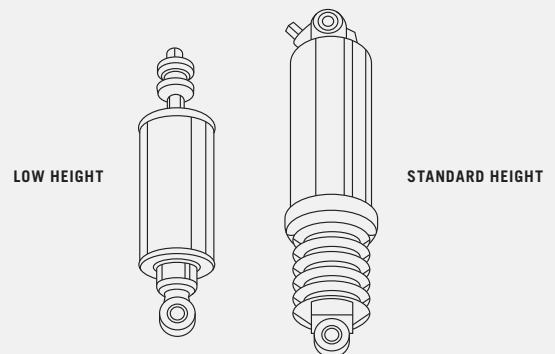

SUSPENSION

Adjusting your motorcycle's ride height by raising or lowering the suspension is often the first step in fitting the bike to your stature. Being sure-footed at a stop can really increase your sense of confidence.

SEE PAGE 198

MILWAUKEE-EIGHT® SOFTAIL® 173

Seating – Low-Profile

NEW



A. BRAWLER SOLO SEAT
(52000301 SHOWN)

A. BRAWLER® SOLO SEAT

When it's time to go it alone, go in style. These premium quality solo saddles feature a smooth, sleek shape that hugs the frame rails for a true custom look. The Brawler® seat's design places the rider "in" the bike for a low-slung riding position, and features a kick-up in the rear to hold the rider in place. The Brawler seat features a unique hidden post and grommet seat mount for a clean custom look, and the fastback tail is accented with a custom medallion set into the surface. The custom stitched vinyl seating surface features a subtle inlay of contrasting material, and the contoured foam padding provide a firm but luxurious feel. Seat does not fit with passenger pillions.

52000301 **\$249.95**

Fits '18-later FLDE, FLHC, FLHCS, FLSL and FXBB models. Seat width 10.0". Does not fit with passenger pillions.

52000299 **\$249.95**

Fits '18-later FLFB, FLFBS, FXBR and FXBRS models. Seat width 11.0". Does not fit with passenger pillions.

NEW



A. BRAWLER SOLO SEAT
(52000299 SHOWN)

B. BADLANDER® SEAT

Clean smooth covers, subtle top-stitching and a frame-hugging profile add up to a statement only Harley could create. The low design delivers a reduced seat height that is ideal for riders that want the shortest possible reach to the ground, and the long and lean shape allows tall riders to move back from the hand and foot controls without sitting higher on the bike. This seat is wrapped in water-resistant vinyl and finished with an embroidered Harley-Davidson script. Kit includes grab strap and all mounting hardware.

52000300 **\$299.95**

Fits '18-later FLDE, FLHC, FLHCS, FLSL and FXBB models. FLDE, FLSL, and FXBB models require separate purchase of Passenger Footpegs and Passenger Footpeg Mounting Kit P/N 50500769 or 50500771. Seat width 12.0"; passenger pillion width 5.5".

52000298 **\$299.95**

Fits '18-later FLFB and FXLR models. Seat width 11.0"; passenger pillion width 6.0".

52000297 **\$299.95**

Fits '18-later FLFB, FLFBS, FXBR and FXBRS models. Seat width 12.5"; passenger pillion width 6.0".

NEW



B. BADLANDER SEAT
(52000300 SHOWN)

NEW



B. BADLANDER SEAT
(52000298 SHOWN)

Notice: The prices appearing in this catalog are the manufacturer's suggested retail prices. Actual retail prices may vary.

SOFTAIL

174 MILWAUKEE-EIGHT® SOFTAIL®

Seating – Reach®

REACH® SOLO SEATS

From the custom metal Harley-Davidson® medallion to the sleek fast-back design, this seat is shaped to deliver the ergonomic position that a shorter rider needs. Sculpted and molded to ease the reach to the ground, this Reach® Solo seat positions the rider closer to the controls when compared to the stock seat. The narrow nose and the seating position provides the rider with added confidence and control while the bike is at a stop or during parking maneuvers, while the generous seating width adds support for the long haul. And the seat's upturned tail keeps you in place without confining you to one position. For maximum comfort and support, these seats are recommended for riders between 5'-2" and 5'-8" tall.

A. REACH SOLO SEAT – DELUXE STYLING

Styled to complement the classic looks of the Softail® Deluxe model, this Reach Solo Seat features double-row stitching down the center of the seating surface, and premium leather valance side panels with decorative inserts. Matching Passenger Pillion P/N 52400175 is available.

Measurements as compared to other seating options:

- Stock '18 Deluxe model seat – 1.5" forward
- Stock '18 Heritage model seat – 1.5" forward

52000302 **\$289.95**

Fits '18-later FLDE, FLHC and FLHCS models. Does not fit with FLHC or FLHCS Original Equipment passenger pillion. Seat width 14.5".

B. REACH SOLO SEAT – SOFTAIL SLIM STYLING

This minimalistic Reach Solo Seat features a classic tuck & roll design that perfectly complements the bobber style of the Softail Slim® models. Matching Passenger Pillion P/N 52400129 is available.

Measurements as compared to other seating options:

- Stock '18 Softail Slim model seat – 1.25" forward.

52000303 **\$289.95**

Fits '18-later FLSL models. Seat width 11.5".

C. REACH SOLO SEAT – '18 BREAKOUT STYLING

This comfortable Reach Solo Seat is styled to match the Softail® Breakout® model's Original Equipment seat and features rich red stitching, a textured vinyl inlay and Harley-Davidson® medallion insert. The seating surface and stitching complements the model year '18 Original Equipment passenger pillion.

Measurements as compared to other seating options:

- Stock '18 Breakout model seat – 1.5" forward.

52000304 Red Stitching. **\$289.95**

Fits '18-later FXBR and FXBRS models equipped with Original Equipment passenger pillion or Sundowner Pillion P/N 52400225 or 52400169. Seat width 13.0".

D. REACH SOLO SEAT – '19 BREAKOUT STYLING

This comfortable Reach Solo Seat is styled to match the Softail Breakout model's Original Equipment seat and features grey stitching, a textured vinyl inlay and Harley-Davidson medallion insert. The seating surface and stitching complements the model year '19 Original Equipment passenger pillion.

Measurements as compared to other seating options:

- Stock '19 Breakout model seat – 1.5" forward.

52000430 Grey Stitching. **\$289.95**

Fits '18-later FXBR and FXBRS models equipped with Original Equipment passenger pillion or Sundowner Pillion P/N 52400225 or 52400169. Seat width 13.0".



A. REACH SOLO SEAT – DELUXE STYLING



B. REACH SOLO SEAT – SOFTAIL SLIM STYLING



C. REACH SOLO SEAT – '18 BREAKOUT STYLING, RED STITCH (SHOWN WITH ORIGINAL EQUIPMENT PILLION)



D. REACH SOLO SEAT – '19 BREAKOUT STYLING, GREY STITCH

Notice: The prices appearing in this catalog are the manufacturer's suggested retail prices. Actual retail prices may vary.

MILWAUKEE-EIGHT® SOFTAIL® 175

Seating – Reach®

E. REACH® SOLO SEAT – FAT BOY STYLING

This Reach® Solo Seat puts you closer to the controls without sacrificing the Fat Boy® model's head-turning style. The seat features stitching and seat textures that are a perfect match for the Original Equipment passenger pillion.

Measurements as compared to other seating options:

- Stock '18 Fat Boy model seat – 1.0" forward.

52000352

\$289.95

Fits '18-later FLFB and FLFB models equipped with Original Equipment passenger pillion or Sundowner Pillion P/N 52400170. Seat width 14.0".



**E. REACH SOLO SEAT – FAT BOY STYLING
(SHOWN WITH ORIGINAL EQUIPMENT PILLION)**

REACH TWO-UP SEATS

Designed to position riders with a shorter inseam closer to the ground, Two-Up Reach Seats are shaped to place the rider in a comfortable and confident relationship to the hand and foot controls. The wide seating surface provides loads of support and the narrow tapered nose brings the rider's legs together for an easier reach to the ground at a stop. These Two-Up Reach Seats feature a stepped profile that keeps the rider from sliding rearward during acceleration, and a generous raised passenger position that cradles the tailbone for hours of riding comfort. The rich vinyl seating surface is accented with a classic Harley-Davidson® medallion.

F. REACH TWO-UP SEAT – SPORT GLIDE® STYLING

Designed to look like a separate solo seat and pillion, this smooth vinyl one-piece Reach Two-Up Seat perfectly complements the sweeping lines of the Low Rider® model.

Measurements as compared to other seating options:

- Stock '18 Low Rider model seat – 0.5" lower, 1.5" forward.

52000354

\$389.95

Fits '18-later FLFB and FLFB models. Seat width 12.0"; passenger pillion width 5.5".



F. REACH TWO-UP SEAT – SPORT GLIDE STYLING

G. REACH TWO-UP SEAT – FAT BOB® STYLING

Designed to reflect the technical style of the Original Equipment Fat Bob® seat, this Reach Two-Up seat features textured suede-like seating surfaces for grip, and raised center panels for a tough, tactical look.

Measurements as compared to other seating options:

- Stock '18 Fat Bob model seat – 0.5" lower, 1.25" forward.

52000353

\$389.95

Fits '18-later FXFB and FXFB models. Seat width 11.0"; passenger pillion width 6.0".



G. REACH TWO-UP SEAT – FAT BOB STYLING

Notice: The prices appearing in this catalog are the manufacturer's suggested retail prices. Actual retail prices may vary.

176 MILWAUKEE-EIGHT® SOFTAIL®

Seat – TallBoy®

TALLBOY® TWO-UP SEATS

The correct riding position can help a tall rider sit comfortably on the bike and avoid leg cramps and back strain during a long day in the saddle. For riders with a longer inseam, a Tallboy® Seat moves the rider up and back from the stock seating position to eliminate the "knees-high" riding position and effectively place the body for a natural arm and leg reach to the controls. Tallboy Seats feature a bucket-shaped design and a wide seating surface to reduce pressure on the rider's tailbone, without looking bulky or overstuffed. And the passenger pillion is shaped and padded to maximize passenger comfort. The rich vinyl seating surface is accented with a round Harley-Davidson medallion.

A. TALLBOY TWO-UP SEAT – DELUXE, HERITAGE, SOFTAIL SLIM® AND STREET BOB®

Measurements as compared to other seating options:

- Stock '18 Deluxe model seat – 2.5" rearward, 1.0" higher.
- Stock '18 Heritage model seat – 2.5" rearward, 1.0" higher.
- Stock '18 Slim model seat – 1.75" rearward, 1.75" higher.
- Stock '18 Street Bob® model seat – 2.5" rearward, 1.0" higher.

52000355 **\$389.95**

Fits '18-later FLDE, FLHC, FLHCS, FLSL and FXBB models. Seat width 14.5"; passenger pillion width 9.75".



A. TALLBOY TWO-UP SEAT – DELUXE, HERITAGE, SOFTAIL SLIM AND STREET BOB

B. TALLBOY TWO-UP SEAT – FAT BOY® AND BREAKOUT®

Measurements as compared to other seating options:

- Stock '18 Fat Boy® model seat – 3.5" rearward, 0.75" higher.
- Stock '18 Breakout® model seat – 1.75" rearward, 1.25" higher.

52000356 **\$389.95**

Fits '18-later FLFB, FLFBS, FXBR and FXBRS models. Seat width 14.25"; passenger pillion width 10.0".



B. TALLBOY TWO-UP SEAT – FAT BOY AND BREAKOUT

C. TALLBOY TWO-UP SEAT – LOW RIDER®

Measurements as compared to other seating options:

- Stock '18 Low Rider® model seat – 2.75" rearward, 1.0" higher.

52000305 **\$389.95**

Fits '18-later FL5B and FXLR models. Seat width 14.5"; passenger pillion width 9.0".



C. TALLBOY TWO-UP SEAT – LOW RIDER

Notice: The prices appearing in this catalog are the manufacturer's suggested retail prices. Actual retail prices may vary.

MILWAUKEE-EIGHT® SOFTAIL® 177

Seating – Hammock



D. HARLEY HAMMOCK TOURING SEAT

D. HARLEY® HAMMOCK TOURING SEATS

Stay in the saddle all day. These Harley® Hammock seats feature broad seating surfaces and a shallow bucket shape to distribute the weight and reduce pressure points. Beneath the two inches of traditional dual-density foam, the rider's weight is supported by a revolutionary fabric suspension system. The sling-like suspension system is integrated into the seat and acts like a hammock, providing two inches of suspension above the seat pan. This internal system prevents bottoming out and provides a 30% improvement in comfort and endurance over the long haul by sheltering the rider from pothole and highway expansion joint impacts. The seat's diamond-stitched vinyl surface is easy to clean and maintain, and it can be equipped with an optional Rider Backrest for additional back support.

52000294 **\$529.95**
Fits '18-later FLFB, FLFBS, FXBR and FXBRS models. Seat width 16.5"; passenger pillion width 10.75".

52000290 **\$529.95**
Fits '18-later FLDE, FLHC, FLHCS, FLSL and FXBB models. Seat width 16.0"; passenger pillion width 11.25".

Shown with:

ADJUSTABLE RIDER BACKREST

Add back support for long-haul riding comfort. This contoured backrest pad is shaped to provide full lower back support without pushing the rider forward and the slim profile maximizes the available passenger space. An adjustable support bracket with four mounting locations accommodates different seats and riding positions. The backrest pad angle can be adjusted for maximum comfort.

52300409 **\$139.95**
Fits '18-later FLDE, FLHC, FLHCS, FLSL, FXBB, FLFB, FLFBS, FXBR, and FXBRS models equipped with Signature Hammock Seat P/N 52000290 or 52000294. Backrest pad width 11.25".



**D. HARLEY HAMMOCK TOURING SEATS
(FAT BOY MODEL SHOWN)**



**D. HARLEY HAMMOCK TOURING SEATS
(DELUXE MODEL SHOWN WITH OPTIONAL RIDER BACKREST)**

Notice: The prices appearing in this catalog are the manufacturer's suggested retail prices. Actual retail prices may vary.

178 MILWAUKEE-EIGHT® SOFTAIL®

Seating – Sundowner™

SUNDOWNER™ SOLO SEATS

Ride sun-up to sun-down in comfort and style. The Sundowner™ Solo Seat's shape and foam density were developed and refined during hundreds of hours of test rides and ergonomic evaluations. The unique seat features a deep bucket design that cradles the tailbone and provides back support for the rider. The narrow nose of the seat was sculpted to bring the legs closer together, and to look great where it meets the tail of the fuel tank. The seats are constructed with premium vinyl surfaces for comfort and durability.

A. SUNDOWNER SOLO SEAT – DELUXE AND HERITAGE SOFTAIL®

Styled with rounded curves and stitched center panels, this wide Sundowner Solo Seat complements the styling of classic Softail® models. Matching Passenger Pillion P/N 52400168 is available for Softail Deluxe and Heritage models.

52000291 **\$249.95**

Fits '18-later FLDE, FLHC and FLHCS models. Seat width 16.5".

B. SUNDOWNER SOLO SEAT – '18 BREAKOUT® STYLING

This Sundowner Solo Seat is styled to match the Softail Breakout® model's model year '18 Original Equipment seat and features a textured vinyl inlay, rich red stitching and a blacked-out Harley-Davidson® medallion insert. For a two-up ride, combine the solo seat with the Original Equipment or a matching Sundowner Passenger Pillion P/N 52400169.

52000292 Red Stitching. **\$249.95**

Fits '18-later FXBR and FXBRS models. Seat width 16.75".

C. SUNDOWNER SOLO SEAT – '19 BREAKOUT STYLING

This Sundowner Solo Seat is styled to match the Softail Breakout model's model year '19 Original Equipment seat and features a textured vinyl inlay, grey stitching and a blacked-out Harley-Davidson medallion insert. For a two-up ride, combine the solo seat with the Original Equipment or a matching Sundowner Passenger Pillion P/N 52400225.

52000429 Grey Stitching. **\$249.95**

Fits '18-later FXBR and FXBRS models. Seat width 16.75".

D. SUNDOWNER SOLO SEAT – FAT BOY®

Smooth vinyl and double row stitched side panels define the look of the Sundowner Solo Seat for Fat Boy® models, and perfectly complement the Original Equipment passenger pillion. Or for additional passenger comfort, team this seat with the matching Sundowner Pillion P/N 52400170.

52000293 **\$249.95**

Fits '18-later FLFB and FLFBS models. Seat width 16.25".



A. SUNDOWNER SOLO SEAT – DELUXE AND HERITAGE SOFTAIL (DELUXE SHOWN WITH SUNDOWNER PILLION)



B. SUNDOWNER SOLO SEAT – '18 BREAKOUT, RED STITCHING (SHOWN WITH SUNDOWNER PILLION)



C. SUNDOWNER SOLO SEAT – '19 BREAKOUT, GREY STITCH



D. SUNDOWNER SOLO SEAT – FAT BOY (SHOWN WITH SUNDOWNER PILLION)

Notice: The prices appearing in this catalog are the manufacturer's suggested retail prices. Actual retail prices may vary.

MILWAUKEE-EIGHT® SOFTAIL® 179

Seating – Sundowner™



E. SUNDOWNER SEAT – DELUXE, HERITAGE SOFTAIL, SOFTAIL SLIM & STREET BOB

SUNDOWNER™ TWO-UP SEATS

The Sundowner™ Seat provides the maximum in long-riding comfort. The deep-bucket design puts your body in the proper touring position and the generous padding makes it comfortable for both the rider and passenger as the miles are adding up. The dish shape provides added rider back support and the wide passenger pillion is shaped to minimize pressure points.

E. SUNDOWNER SEAT – DELUXE, HERITAGE SOFTAIL®, SOFTAIL SLIM® & STREET BOB®

Styled with smooth vinyl covering and generous rider and passenger spaces, this comfortable Sundowner Two-Up Seat is shaped to maximize time in the saddle. But the sweeping center panel stitching and the tapered sides visually shrink the seat to minimize the perceived bulk on a stripped-down Street Bob® or Slim model.

52000295

\$349.95

Fits '18-later FLDE, FLHC, FLHCS, FLSL and FXBB models. Seat width 14.25"; passenger pillion width 10.0".

F. SUNDOWNER SEAT – FAT BOB®

Inspired by the styling of the Original Equipment Fat Bob seat, this Sundowner Two-Up Seat provides long range comfort for both the rider and the passenger, without distracting from the bike's muscular personality.

52000349

\$349.95

Fits '18-later FXFB and FXFBS models. Seat width 14.0"; passenger pillion width 10.25".



F. SUNDOWNER SEAT – FAT BOB

G. SUNDOWNER SEAT – LOW RIDER®

Stitched to match the Original Equipment Low Rider® Seat, this comfortable Sundowner Two-Up Seat is ready to deliver you and your passenger to distant destinations in maximum comfort and style.

52000350

\$349.95

Fits '18-later FLSB and FXLR models. Seat width 15.0"; passenger pillion width 12.25".



G. SUNDOWNER SEAT – LOW RIDER

SOFTAIL

Notice: The prices appearing in this catalog are the manufacturer's suggested retail prices. Actual retail prices may vary.

180 MILWAUKEE-EIGHT® SOFTAIL®

Seating & Pillion

A. PASSENGER PILLION – STREET BOB®/SOFTAIL SLIM® STYLING*

Bring a passenger along for the ride. This easy-to-install detachable Passenger Pillion features a tuck and roll cover styled to match the Original Equipment solo seat. Kit includes mounting hardware and grab strap.

52400128 Street Bob Styling. **\$174.95**
Fits '18-later FXBB models with Original Equipment solo seat. Requires separate purchase of Passenger Footpegs and Passenger Footpeg Mounting Kit P/N 50500769 or 50500771. Pillion width 6.75".

52400129 Softail Slim Styling. **\$174.95**
Fits '18-later FLSL models with Original Equipment solo seat or Reach Solo Seat P/N 52000303. Requires separate purchase of Passenger Footpegs and Passenger Footpeg Mounting Kit P/N 50500769 or 50500771. Pillion width 6.75".



A. PASSENGER PILLION – SOFTAIL STREET BOB STYLING



A. PASSENGER PILLION – SOFTAIL SLIM STYLING



B. TOURING PASSENGER PILLION – SOFTAIL DELUXE STYLING

B. TOURING PASSENGER PILLION – SOFTAIL® DELUXE STYLING*

Styled to match the stitching and texture of the Softail® Deluxe Original Equipment or the Reach® solo rider seat, these stylish pillions provide an extra comfortable ride for your passenger on those long journeys. Easy to install without removal of the rider seat, this kit includes mounting hardware and matching grab strap.

52400175 Softail Deluxe Styling. **\$174.95**
Fits '18-later FLDE models with Original Equipment solo seat or Reach Solo Seat P/N 52000302. Requires separate purchase of Passenger Footpegs and Passenger Footpeg Mounting Kit P/N 50500769 or 50500771. Pillion width 9.75".



C. SUNDOWNER PASSENGER PILLION – HERITAGE SOFTAIL STYLING



D. SUNDOWNER PASSENGER PILLION – DELUXE & HERITAGE SOFTAIL

C. SUNDOWNER PASSENGER PILLION – HERITAGE SOFTAIL® STYLING*

Styled with double row center panel stitching and blacked-out rectangular studs, this comfortable Sundowner™ Passenger Pillion is a perfect replacement for the minimalistic Original Equipment passenger seat.

52400171 **\$189.95**
Fits '18-later FLHC and FLHCS models with Original Equipment Solo Seat. Passenger pillion width 11.25".

D. SUNDOWNER PASSENGER PILLION – DELUXE & HERITAGE SOFTAIL*

Turn your Sundowner Solo Seat equipped ride into the ultimate two-up touring machine. Styled to match the Sundowner Solo Seat P/N 52000291, this seat will keep your passenger happy for hours in the saddle.

52400168 **\$179.95**
Fits '18-later FLDE, FLHC and FLHCS models with Sundowner Solo Seat P/N 52000291. Passenger pillion width 11.25".



E. SUNDOWNER PASSENGER PILLION – BREAKOUT, RED STITCHING



E. SUNDOWNER PASSENGER PILLION – BREAKOUT, GREY STITCHING

E. SUNDOWNER PASSENGER PILLION – BREAKOUT®*

Shaped for maximum passenger comfort, this Sundowner Passenger Pillion is the perfect match for your Breakout® model's Original Equipment or Sundowner Solo Seat.

Fits '18-later FXBR and FXBRS models with Original Equipment solo seat, Sundowner Solo Seat P/N 52000429 or 52000292, or Reach Solo Seat P/N 52000304 or 52000430. Passenger pillion width 11.75".

52400169 Red Stitch. **\$189.95**
52400225 Grey Stitch. **\$189.95**

F. SUNDOWNER PASSENGER PILLION – FAT BOY®*

This sculpted pillion will keep your passenger comfortable as the miles add up. Styled to match the Fat Boy® Original Equipment or Sundowner Solo Seat P/N 52000293.

52400170 **\$189.95**
Fits '18-later FLFB and FLFBS models with Original Equipment solo seat, Sundowner Solo Seat P/N 52000293, or Reach Solo Seat P/N 52000352. Passenger pillion width 12.0".



F. SUNDOWNER PASSENGER PILLION – FAT BOY



G. PASSENGER PILLION – FXDR 114 STYLING

G. PASSENGER PILLION – FXDR 114 STYLING

This pillion is a perfect match with the stock rider seat.

52400186 **\$209.95**
Fits '19-later FXDRS models equipped with Original Equipment solo seat. Requires separate purchase of Passenger Footpeg Kit P/N 50501128. Seat width 10.25".



***WARNING:** Do not install on models that are not equipped with passenger footpegs. Doing so could result in death or serious injury.

Notice: The prices appearing in this catalog are the manufacturer's suggested retail prices. Actual retail prices may vary.

MILWAUKEE-EIGHT® SOFTAIL® 181

Seating Accessories



H. ROAD ZEPPELIN SEAT PAD

H. ROAD ZEPPELIN® SEAT PAD

Experience ultimate comfort. Designed to ensure hours of comfort in the saddle, Road Zeppelin® Seat Pads are equipped with a unique air bladder system that allows your weight to be supported evenly across the entire seating surface. Whether you have a low profile seat or a larger more comfortable seat, you will feel the benefits. This air bladder system is designed to reduce pressure points, provide shock absorption, and reduce vibration. Unlike other mouth-inflated seat pads, the Road Zeppelin Pad features an easy-to-reach integrated hand pump and metered air release valve that permits quick and controllable adjustment. You can easily adjust the comfort and support while seated on the pad. The UV-stable and snag resistant mesh cover allows air to circulate beneath the rider's body, reducing the temperature trapped between the rider and seat. Shaped to conform to most Harley-Davidson® seats, the pads feature adjustable mounting straps and a non-skid surface to keep them in place. The hand-washable seat pad can be deflated and rolled for compact storage.

52000327 Rider. **\$169.95**

Fits rider position on all models equipped with Original Equipment or accessory seats. Also fits passenger position on Touring models with large pillion area. Pad width – 14.0".

52400162 Passenger. **\$149.95**

Fits Original Equipment and accessory passenger pillions. Pad length – 12.0"; width – 9.0".



I. CIRCULATOR SEAT AND WIDE BACKREST PADS

I. CIRCULATOR SEAT AND BACKREST PADS

Keep comfortable on your next long ride. These breathable Circulator Pads feature 3-D construction that promotes air movement and reduces heat build-up where the rider's body touches the seat or backrest. Designed to keep the rider cool by reducing the perspiration build-up between you and the seating surface, the Circulator Pad can be installed and removed in seconds for easy cleaning. The low-profile design minimizes seat-height change compared to inflatable pads, while enhancing comfort with its shock-absorbing construction. Manufactured of UV-stable materials, these seat pads resist fading when exposed to the sun. Elastic under-seat strap and non-slip base provide secure installation and the available Circulator Passenger Pillion Pad attaches to the rider pad with hook-and-loop tabs.

51076-10 Large Seat Pad. **\$99.95**

Fits Softail®, Touring and Trike models with Original Equipment and accessory seats. Will not fit Bobber or Road Zeppelin seats. Pad width – 16.0".

51078-10 Passenger Pillion Pad. **\$69.95**

Fits Original Equipment and accessory passenger pillions. Pad width – 13.0".

52300103 Wide Backrest Pad. **\$59.95**

Fits wide profile rider and passenger backrest pads up to 12.0" wide and 9.0" tall.

J. RAIN COVERS*

Featuring a handy storage sack, this black nylon, water-resistant, Cordura® cover packs easily and shelters your seat from the storm.

51638-97 Solo Seat. **\$29.95**

Fits H-D® solo seats (except XR and FLSTS).

51639-97 Two-Up. **\$31.95**

Fits VRSC™, XG, XL, Dyna® and Softail models with Two-Up seats. Does not fit Touring and Trike models. Does not fit with Rider Backrests.



J. RAIN COVER – SOLO SEAT



J. RAIN COVER – TWO-UP



***WARNING:** Do not use while riding; could result in death or serious injury.

Notice: The prices appearing in this catalog are the manufacturer's suggested retail prices. Actual retail prices may vary.

182 MILWAUKEE-EIGHT® SOFTAIL®

Seating – Solo Saddles

A. TUCK & ROLL SOLO SADDLE

Add nostalgic bobber looks to your modern Harley-Davidson® motorcycle. This Solo Saddle features a classic tuck & roll vinyl seating surface that is wrapped around a poured and contoured pad that maximizes comfort while maintaining the minimalistic “just enough to ride” look. The smooth gloss black metal seat pan provides a clean, custom look. Easy to install, the combination of the bolt-on seat and the model-specific Spring Seat Installation Kit (sold separately) includes everything you need to get the bobber look. The Installation Kit includes beehive style springs that help cushion the ride, or for maximum old school style, add the low profile Rigid Mount Kit for a truly slammed look. No cutting, welding or fabrication is necessary and the seat can be removed and replaced with a touring seat for a two-up night on the town.

52000315 **\$299.95**

Fits '18-later FLSL and FXBB models. Installation requires purchase of Spring Seat Mounting Kit P/N 52100029. Does not fit with passenger pillions.



A. TUCK & ROLL SOLO SADDLE

B. BOBBER SOLO SADDLES

How low can you go? This classic solo seat takes the stripped-down garage-built look about as far as you can go. The thick leather cover and slim foam filler are bonded directly to the formed metal seat pan and to minimize the ride height and to maximize the style. The smooth gloss black metal seat pan provides a clean, custom look. Easy to install, the combination of the bolt-on seat and the model-specific Spring Seat Installation Kit (sold separately) includes everything you need to get the bobber look. The Installation Kit includes beehive style springs that help cushion the ride, or for maximum old school style, add the low profile Rigid Mount Kit for a truly slammed look. No cutting, welding or fabrication is necessary and the seat can be removed and replaced with a touring seat for a two-up night on the town.

Fits '18-later FLSL and FXBB models. Installation requires purchase of Spring Seat Mounting Kit P/N 52100029. Does not fit with passenger pillions.

DISTRESSED BLACK LEATHER SOLO SADDLE

The black distressed raw-edge leather pad is joined to the pan with antique nickel-look rivets, and features a blacked-out “Milwaukee Since 1903” medallion. Tanned in Italy, the 4.5oz weight Eureka leather features a Bar & Shield logo embossed into the surface as a finishing touch.

52000320 **\$299.95**

SMOOTH BLACK LEATHER SOLO SADDLE

Minimalistic smooth black leather saddle features a gloss black steel trim ring that surrounds the perimeter of the seat. The trim ring is riveted to the seat pan and sandwiches the edge of the leather for a clean look.

52000314 **\$299.95**

ANTIQUÉ BROWN LEATHER SOLO SADDLE

Covered with rich brown pull-up leather, this custom look bobber seat will gain character with use. The supple leather is tanned by Milwaukee's own Seidel Tanning Company, and the seat wears its authentic hometown look in classic style. The 3.5oz raw-edge leather covers a minimal pad, and is accented with an embossed Bar & Shield logo. The leather is bonded to the seat pan with real brass rivets, and the matching “Milwaukee Since 1903” trim will develop a rich patina with age.

52000381 **\$299.95**



B. BOBBER SOLO SADDLES – DISTRESSED BLACK LEATHER



B. BOBBER SOLO SADDLES – SMOOTH BLACK LEATHER



B. BOBBER SOLO SADDLES – ANTIQUÉ BROWN LEATHER

Notice: The prices appearing in this catalog are the manufacturer's suggested retail prices. Actual retail prices may vary.

MILWAUKEE-EIGHT® SOFTAIL® 183

Seating – Accessories



NEW



C. SPRING SADDLE INSTALLATION KIT



NEW



D. RIGID MOUNT SADDLE INSTALLATION KIT



E. QUICK-RELEASE SEAT HARDWARE KIT – CHROME



E. QUICK-RELEASE SEAT HARDWARE KIT – GLOSS BLACK



F. TANK KNEE PAD KIT

C. SPRING SADDLE INSTALLATION KIT

Achieve the optimum balance of style and function. Required when fitting a Spring Solo Saddle on '18-later Street Bob® and Slim models, this kit includes everything needed for a simple bolt-on installation. The kit features beehive style springs that maximize seat travel while maintaining a low profile, a custom formed steel under-seat cover, a polished stainless steel hinge, and all necessary hardware. The under-seat cover is finished in gloss black, and features a stainless steel mesh accent panel. The seat can be tilted forward, permitting removal of the under-seat panel and easy access to suspension adjustment. Want a really low profile ride? Simply swap the beehive springs with the Rigid Mount Saddle Installation Kit P/N 52100043 (sold separately) for a truly slammed look.

52100029 **\$229.95**

Fits '18-later FLSSL and FXBB models.

D. RIGID MOUNT SADDLE INSTALLATION KIT

Get the low lean minimalistic garage built look when you want it. Designed for installation in conjunction with the Spring Saddle Installation Kit P/N 52100029, this kit lets you swap the beehive springs with short post mounts for a truly slammed look. And when you need a little more cushion, these posts can easily be replaced with the original springs. Kit includes two gloss black aluminum threaded posts and grommets.

52100043 **\$49.95**

Fits '18-later FLSSL and FXBB models. Requires separate purchase of Spring Saddle Installation Kit P/N 52100029.

E. QUICK-RELEASE SEAT HARDWARE KIT

This Quick-Release Hardware Kit allows the rider to remove one-piece Harley-Davidson® seats quickly and easily. The knurled knob is easy to install or remove without tools, and the nylon washer keeps the finger tightened knob in place and rattle free. A raised-logo Harley-Davidson emblem finishes the look. SAE 1/4"-20 thread.

Fits '97-later XG, XL, Dyna®, Softail® (except '12-'17 FLS models equipped with Original Equipment seat), Touring and Trike models equipped with SAE 1/4"-20 seat mount hardware. Does not fit seats equipped with spring-loaded rear seat bracket.

51676-97A Chrome. **\$19.95**

10500093 Gloss Black. **\$19.95**

F. TANK KNEE PAD KIT

These self-adhesive rubber knee pads provide a touch of old school style. The rich black rubber pads feature tapered ribs and a raised Bar & Shield logo to protect the surfaces where your legs contact the tank. The compact pads measure 7.0" by 2.75", and are flexible enough to fit many tank profiles. Sold in matched pairs.

57300065 **\$39.95**

Fits fuel tanks on many Street™, Sportster®, Dyna and Softail models. May cover a portion of fuel tank graphics, check appearance before adhering to tank.

SOFTAIL

Notice: The prices appearing in this catalog are the manufacturer's suggested retail prices. Actual retail prices may vary.

COMFORT ON THE GO

With a detachable backrest and luggage rack, your bike can go from a stripped-down afternoon cruiser to a fully loaded two-up touring machine in seconds. Comfort and convenience-driven accessories make for a less stressful ride.

EQUIPPED FOR THE MILES AHEAD

Solo and stripped down, two-up and fully loaded, or anywhere in between, you can tailor any Harley-Davidson® motorcycle to meet the demands of the highway.



PASSENGER BACKRESTS

For passenger comfort and peace of mind, installing a passenger backrest is essential. Start with a HoldFast™ One Piece Sissy Bar in your choice of height and add a matching backrest pad.

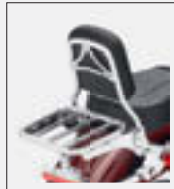

SPORT LUGGAGE RACKS

With a Sport Luggage Rack attached to the passenger backrest, you can carry your lunch to work or you can carry all your gear on a trip across the country.



TWO-UP LUGGAGE RACKS

For the rider that doesn't need a passenger backrest, a HoldFast™ Two-Up Luggage Rack allows you to easily add a place to secure your luggage.



SOLO LUGGAGE RACKS

Add touring capabilities to your solo seat model in seconds. This detachable Solo Rack fits over the fender when the passenger pillion is removed.

DETACHABLE BASICS

HoldFast™ One-Piece Uprights feature an exclusive latch system that permits the backrest to be installed or removed in seconds to add versatility to your ride. The HoldFast sissy bar upright simply slips into position on the docking points, and the fingertip latches are clicked into position for a positive lock.

1 UNLATCH

Pull the HoldFast latches to release the rack or sissy bar from the docking points.

2 LIFT

Pivot the rack or sissy bar forward to clear the rear docking points.

3 REMOVE

Lift the rack or sissy bar free from the front docking points.



THE FLEXIBILITY OF SUPPORT

A HoldFast™ detachable sissy bar and passenger backrest pad is the starting point to build a complete touring machine.

The backrest provides long-range comfort and support while adding a feeling of control and confidence for the passenger. Once the Docking Hardware Kit is installed, adding or removing a HoldFast detachable accessory is a simple “pivot and click” proposition.

DETACHING A HOLDFAST™ ACCESSORY



INSTALL

Position the sissy bar to pivot on the front docking points. Rotate the backrest to engage the rear docking points, and lock it into place with a gentle downward push. That's all there is to do.



REMOVE

Grasp and pull the latching tabs rearward to release the sissy bar and pivot forward to clear the rear docking points. Lift the upright free from the front docking points, and you're done.



A. HOLDFAST™ DOCKING HARDWARE KIT

The ideal choice for maximum versatility, this complete kit contains the docking hardware necessary to install all HoldFast™ detachable accessory options. Even if you only install a passenger backrest today, this kit allows you to add additional accessories as your touring demands change. Kit includes docking points to allow installation of H-D® Detachables™ Sissy Bar, Solo Luggage Rack, Two-Up Luggage Rack, Solo Tour-Pak® Rack or Two-Up Tour-Pak Rack.

Fits '18-later FLFB, FLFBS, FXBR and FXBRS models.

52300376 Chrome. **\$49.95**

52300377 Gloss Black. **\$49.95**

Fits '18-later FLDE, FLHC, FLHCS, FLSB, FLSL, FXBB, FXFB, FXFBS and FXLR models.

52300378 Chrome. **\$49.95**

52300379 Gloss Black. **\$49.95**

186 MILWAUKEE-EIGHT® SOFTAIL®

Backrests & Rack

A. HOLDFAST™ SISSY BAR UPRIGHT

A sissy bar and passenger backrest pad is the starting point for building a complete touring machine. The backrest adds long-range comfort and support and provides a feeling of confidence and control for the passenger. HoldFast™ One-Piece Uprights feature an exclusive latch system that permits the backrest to be installed or removed in seconds to add versatility to your ride. The HoldFast sissy bar upright simply slips into position on the docking points, and the fingertip latches are clicked into position for a positive lock. HoldFast Sissy Bars are available in short and standard height for optimized passenger back support. A wide variety of Backrest Pads are available to match your comfort or customizing requirements, and the kit includes a matching 3-point backrest pad mount bracket.

Fits '18-later FLDE, FLHC, FLHCS, FLSL, and FXBB models. Installation requires separate purchase of model-specific Docking Hardware Kit.

52300442	Standard-Height, Chrome.	\$199.95
52300446	Standard-Height, Gloss Black.	\$199.95
52300444	Short, Chrome.	\$199.95
52300448	Short, Gloss Black.	\$199.95

Fits '18-later FLFB, FLFB, FXBR and FXBRS models. Installation requires separate purchase of model-specific Docking Hardware Kit.

52300437	Standard-Height, Chrome.	\$199.95
52300439	Standard-Height, Gloss Black.	\$199.95
52300436	Short, Chrome.	\$199.95
52300441	Short, Gloss Black.	\$199.95

Fits '18-later FXFB and FXFBS models. Installation requires separate purchase of model-specific Docking Hardware Kit.

52300454	Standard-Height, Gloss Black.	\$199.95
52300456	Short, Gloss Black.	\$199.95

Fits '18-later FLSB and FXLR models. Installation requires separate purchase of model-specific Docking Hardware Kit.

52300432	Standard-Height, Chrome.	\$199.95
52300434	Standard-Height, Gloss Black.	\$199.95
52300433	Short, Chrome.	\$199.95
52300435	Short, Gloss Black.	\$199.95



A. HOLDFAST SISSY BAR UPRIGHT – CHROME



A. HOLDFAST SISSY BAR UPRIGHT – GLOSS BLACK



A. SHORT HOLDFAST SISSY BAR UPRIGHT – CHROME (DELUXE MODEL SHOWN)



A. STANDARD-HEIGHT HOLDFAST SISSY BAR UPRIGHT – GLOSS BLACK (HERITAGE SOFTAIL MODEL SHOWN)



A. STANDARD-HEIGHT HOLDFAST SISSY BAR UPRIGHT – GLOSS BLACK (FAT BOB MODEL SHOWN)



A. SHORT HOLDFAST SISSY BAR UPRIGHT – CHROME (BREAKOUT MODEL SHOWN)



A. STANDARD-HEIGHT HOLDFAST SISSY BAR UPRIGHT – GLOSS BLACK (LOW RIDER MODEL SHOWN)



A. SHORT HOLDFAST SISSY BAR UPRIGHT – GLOSS BLACK (LOW RIDER MODEL SHOWN)

Notice: The prices appearing in this catalog are the manufacturer's suggested retail prices. Actual retail prices may vary.

MILWAUKEE-EIGHT® SOFTAIL® 187

Backrests & Rack

NEW



B. ONE-PIECE TALL RIGID MOUNT SISSY BAR

B. ONE-PIECE TALL RIGID MOUNT SISSY BAR

Strap on your bed roll or your backpack, and hit the road. This classic paper-clip style sissy bar is the perfect finishing touch to a stripped-down bobber motorcycle build. The 21" tall sissy bar features a rolled steel upright that is welded to the rigid-mount side plates for a custom made look. Bolted directly to the fender struts, the upright offers a narrow profile and a clean installation. Designed to complement two-up and solo-seat equipped motorcycles, this sissy bar kit includes installation hardware for Passenger Backrest Pad P/N 52300504 (pad sold separately). Available in your choice of gloss black or chrome finish, kit includes installation hardware.

Fits '18-later FLDE, FLHC, FLHCS, FLSL, and FXBB models. Does not fit with BOOM!™ Audio Cruiser Amp & Speaker Expansion Kit P/N 76000666 or 76000700.

52300503	Chrome.	\$209.95
52300502	Gloss Black.	\$209.95

C. PASSENGER BACKREST PAD – 21" TALL SISSY BAR

Add a comfortable back stop for your passenger. This easy-to-install minimalistic pad utilizes the mounting strap included with the Tall Sissy Bar for a clean, tidy look. The smooth vinyl covered pad is styled to complement a wide variety of stock and accessory seats.

52300504 **\$69.95**

Fits '18-later FLDE, FLHC, FLHCS, FLSL and FXBB models equipped with Rigid Mount Tall Sissy Bar Upright P/N 52300502 or 52300503.

NEW



B. ONE-PIECE TALL RIGID MOUNT SISSY BAR

NEW



B. ONE-PIECE TALL RIGID MOUNT SISSY BAR

NEW



C. PASSENGER BACKREST PAD – 21" TALL SISSY BAR

SOFTAIL

Notice: The prices appearing in this catalog are the manufacturer's suggested retail prices. Actual retail prices may vary.

188 MILWAUKEE-EIGHT® SOFTAIL®

Backrests & Racks

A. PASSENGER BACKREST PAD – COMPACT

Sized to complement low-profile custom seats, this Compact Passenger Backrest Pad combines practical passenger support with custom compact style. Pads include mounting bracket and hardware required for attachment to sissy bar upright. Pad height 3.75"; width 6.5".

Fits '18-later Softail® models equipped with Short or Standard Height HoldFast™ Sissy Bar Uprights. Also fits Touring models equipped with Short H-D® Detachables™ Passenger Sissy Bar Upright P/N 52935-04A, 52610-09A or 54248-09A. Will not fit seats with tall passenger pillion pads.

52300559	Smooth Black Vinyl.	\$64.95
52300558	Fat Bob Styling.	\$74.95
52300555	Red Stitch Breakout Styling.	\$74.95
52300617	Grey Stitch Breakout Styling.	\$74.95
52300556	Fat Boy Styling.	\$74.95



A. PASSENGER BACKREST PAD – SMOOTH BLACK VINYL



A. PASSENGER BACKREST PAD – FAT BOB STYLING

B. PASSENGER BACKREST PAD – MID-SIZED

Sized to fit both Low and Standard-Height HoldFast Sissy Bar Uprights, these Mid-Sized Backrest Pads feature a gentle curved shape that cradles the spine and provides hours of passenger comfort. Pad height 7.0"; width 6.75".

Fits '18-later Softail models equipped with Standard Height HoldFast Sissy Bar Uprights. Also fits Touring models equipped with Standard-Height H-D Detachables Passenger Sissy Bar Uprights P/N 52300324, 52627-09A, 54247-09A, 52933-97C or 52805-97B, Tall H-D Detachables Passenger Sissy Bar Upright P/N 52723-06A, Premium H-D Detachables Sissy Bar Upright 52300257 or 52300258.

52300560	Smooth Black Vinyl.	\$74.95
52300557	Low Rider Styling.	\$84.95



A. PASSENGER BACKREST PAD – '18 BREAKOUT STYLING, RED STITCH



A. PASSENGER BACKREST PAD – '19 BREAKOUT STYLING, GREY STITCH

C. BILLET BACKREST PAD MOUNT

Chrome-plated billet aluminum and an engraved Bar & Shield emblem set the tone for this custom Passenger Backrest Mount, which will make you look even better as you're rolling by. Replaces the stock mounting plate and includes chrome-plated mounting hardware.

53086-04		\$69.95
-----------------	--	----------------

Fits Touring models equipped with H-D Detachables Sissy Bar Upright P/N 52805-97B, 52933-97C, 52935-04A, 52723-06A, 52610-09A, 52627-09A, 52300257 or 52300258. Also fits '18-later Softail models equipped with HoldFast Sissy Bar Uprights (except if equipped with Compact Size Pad).



A. PASSENGER BACKREST PAD – FAT BOY STYLING



B. PASSENGER BACKREST PAD – MID-SIZED SMOOTH BLACK VINYL

D. STYLED BACKREST PAD MOUNT

This custom Backrest Mounting Plate replaces the stamped metal mount for a distinctive look. The mirror-finished bracket, chrome-plated mounting hardware and Vivid Black insert contrasts with a leather or vinyl backrest pad to dress your Touring bike in style.

52825-05		\$49.95
-----------------	--	----------------

Fits Touring models equipped with H-D Detachables Sissy Bar Upright P/N 52805-97B, 52935-04A, 52933-97C, 52723-06A, 52610-09A, 52627-09A, 52300257 or 52300258. Also fits '18-later Softail models equipped with HoldFast Sissy Bar Uprights (except if equipped with Compact Size Pad).



B. PASSENGER BACKREST PAD – MID-SIZED LOW RIDER STYLING



C. BILLET BACKREST PAD MOUNT



D. STYLED BACKREST PAD MOUNT

Notice: The prices appearing in this catalog are the manufacturer's suggested retail prices. Actual retail prices may vary.

MILWAUKEE-EIGHT® SOFTAIL® 189

Backrests & Racks

E. SPORT LUGGAGE RACK FOR HOLDFAST™ SISSY BAR UPRIGHTS*

Smooth sweeping curves and the brilliant chrome or gloss black finish defines the look of this Sport Luggage Rack. Designed to complement both short and standard-height HoldFast™ Sissy Bar Uprights, this sleek rack adds a practical and stylish touch to the motorcycle. When firmly bolted to the to the HoldFast Sissy Bar system, the combined backrest and luggage rack can be installed or removed from the bike in seconds for a truly versatile touring or cruising machine. For convenient packing, the side supports of these round bar racks are slotted to accept nylon luggage tie-down straps.

Fits '18-later FLDE, FLHC, FLHCS, FLSL and FXBB models equipped with HoldFast Sissy Bar Upright.

50300124	Chrome.	\$179.95
50300125	Gloss Black.	\$179.95

Fits '18-later FLFB, FLFBS, FXBR and FXBRS models equipped with HoldFast Sissy Bar Upright.

50300126	Chrome.	\$179.95
50300127	Gloss Black.	\$179.95

Fits '18-later FXFB, FXFBS, FLFB, and FXLR models equipped with HoldFast Sissy Bar Upright.

50300130	Chrome.	\$179.95
50300131	Gloss Black.	\$179.95

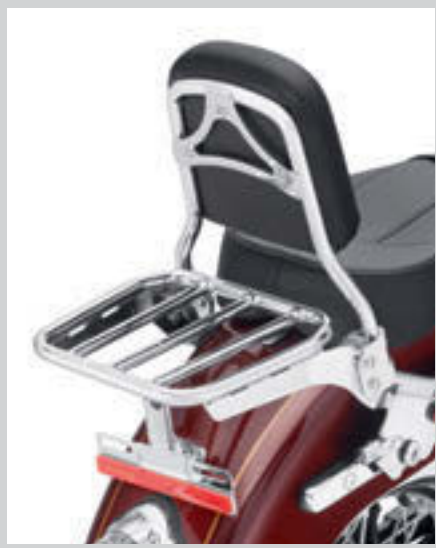

E. SPORT LUGGAGE RACK FOR HOLDFAST SISSY BAR UPRIGHTS – CHROME (DELUXE MODEL SHOWN)



E. SPORT LUGGAGE RACK FOR HOLDFAST SISSY BAR UPRIGHTS – GLOSS BLACK



E. SPORT LUGGAGE RACK FOR HOLDFAST SISSY BAR UPRIGHTS – CHROME (FAT BOY MODEL SHOWN)



E. SPORT LUGGAGE RACK FOR HOLDFAST SISSY BAR UPRIGHTS – GLOSS BLACK (BREAKOUT MODEL SHOWN)



E. SPORT LUGGAGE RACK FOR HOLDFAST SISSY BAR UPRIGHTS – CHROME (LOW RIDER MODEL SHOWN)



E. SPORT LUGGAGE RACK FOR HOLDFAST SISSY BAR UPRIGHTS – GLOSS BLACK (LOW RIDER MODEL SHOWN)



***WARNING:** Do not use this rack as a seat. Do not exceed the fender rack weight capacity. Using as seat or exceeding this capacity could cause handling problems which could result in loss of control and death or serious injury.

Notice: The prices appearing in this catalog are the manufacturer's suggested retail prices. Actual retail prices may vary.

190 MILWAUKEE-EIGHT® SOFTAIL®

Luggage Racks

A. HOLDFAST™ TWO-UP LUGGAGE RACK*

Low-profile styling defines the look of this Two-Up Luggage Rack. Designed to be installed without a sissy bar, this rack is ideal for carrying everything you need on your daily commute. These HoldFast™ Luggage Racks feature an exclusive latch system that permits the rack to be installed or removed in seconds, adding versatility to your ride. The HoldFast rack simply slips into position on the docking points, and the finger-tip latches are clicked into position for a positive lock. Available in mirror chrome or rich gloss black finish, the leading edge of the rack features a flip design that keeps luggage from sliding forward, and provides a convenient tie-down attachment point.

Fits '18-later FLDE, FLHC, FLHCS, FLSL and FXBB models equipped with two-up seats. Installation requires separate purchase of model-specific Docking Hardware Kit. FLHC and FLHCS models with oversize international registration plates may interfere with Luggage Rack and may require separate purchase of License Plate Relocation Kit P/N 67900472.

50300132	Chrome.	\$219.95
50300133	Gloss Black.	\$219.95

Fits '18-later FLFB, FLFBS, FXBR and FXBRS models equipped with two-up seats. Installation requires separate purchase of model-specific Docking Hardware Kit.

50300134	Chrome.	\$219.95
50300135	Gloss Black.	\$219.95

Fits '18-later FLSB and FXLR models equipped with two-up seats. Installation requires separate purchase of model-specific Docking Hardware Kit.

50300136	Chrome.	\$219.95
50300137	Gloss Black.	\$219.95

Fits '18-later FXFB and FXFBS models equipped with two-up seats. Installation requires separate purchase of model-specific Docking Hardware Kit.

50300140	Gloss Black.	\$219.95
-----------------	--------------	-----------------



A. HOLDFAST TWO-UP LUGGAGE RACK – CHROME (DELUXE MODEL SHOWN)



A. HOLDFAST TWO-UP LUGGAGE RACK – GLOSS BLACK



A. HOLDFAST TWO-UP LUGGAGE RACK – CHROME (FAT BOY MODEL SHOWN)



A. HOLDFAST TWO-UP LUGGAGE RACK – GLOSS BLACK (BREAKOUT MODEL SHOWN)



A. HOLDFAST TWO-UP LUGGAGE RACK – CHROME (LOW RIDER MODEL SHOWN)



A. HOLDFAST TWO-UP LUGGAGE RACK – GLOSS BLACK (LOW RIDER MODEL SHOWN)



A. HOLDFAST TWO-UP LUGGAGE RACK – GLOSS BLACK (FAT BOB MODEL SHOWN)



***WARNING:** Do not use this rack as a seat. Do not exceed the fender rack weight capacity. Using as seat or exceeding this capacity could cause handling problems which could result in loss of control and death or serious injury.

Notice: The prices appearing in this catalog are the manufacturer's suggested retail prices. Actual retail prices may vary.

MILWAUKEE-EIGHT® SOFTAIL® 191

Luggage Racks



B. SOLO LUGGAGE RACK*



B. SOLO LUGGAGE RACK*

B. SOLO LUGGAGE RACK*

Add touring capabilities to your solo seat Softail® model. This Solo Rack appears to float over the rear fender, and adds practical luggage space without compromising style. The arching support arms attach to the rear fender strut and the rack is held firmly in place by the seat attachment hardware. Kit includes solo luggage rack and installation hardware.

Fits '18-later FLSL and FXBB models equipped with solo seats.

50300120 Gloss Black. **\$179.95**

Fits '18-later FLDE, FLHC and FLHCS models equipped with solo seats.

50300154 Chrome. **\$179.95**

50300156 Gloss Black. **\$179.95**



B. SOLO LUGGAGE RACK*



B. SOLO LUGGAGE RACK*

C. HOLDFAST™ LOCKING LATCH

Secure your valuables. This locking system allows you to protect your HoldFast™ Sissy Bar, Luggage Rack or Tour-Pak® Mounting Rack from theft, providing security and peace of mind when parking your vehicle. The kit includes (2) keys and (1) locking mechanism

Fits '18-later Softail® models equipped with HoldFast detachable Sissy Bar, Luggage Rack or Solo Tour-Pak Mounting Rack.

52300513 Chrome. **\$54.95**

52300514 Black. **\$54.95**

Fits '18-later Softail models equipped with HoldFast detachable Two-Up Tour-Pak Mounting Rack.

52300518 Chrome. **\$54.95**

52300519 Black. **\$54.95**



C. HOLDFAST LOCKING LATCH – CHROME



C. HOLDFAST LOCKING LATCH – BLACK



**C. HOLDFAST LOCKING LATCH – CHROME
(TOUR-PAK RACK)**



**C. HOLDFAST LOCKING LATCH – BLACK
(TOUR-PAK RACK)**



***WARNING:** Do not use this rack as a seat. Do not exceed the fender rack weight capacity. Using as seat or exceeding this capacity could cause handling problems which could result in loss of control and death or serious injury.

Notice: The prices appearing in this catalog are the manufacturer's suggested retail prices. Actual retail prices may vary.

192 MILWAUKEE-EIGHT® SOFTAIL®

Saddlebags

A. H-D® DETACHABLES™ SADDLEBAGS

Sized for commute to work or a ride across the country, these modern bags are styled to complement the stripped down look of the Softail® cruiser models. These modern waterfall-style saddlebags are completely removable with the simple pull of the internal handle and a rearward slide, leaving your bike stripped down and unencumbered. When removed, the bag leaves behind simple, inconspicuous docking points. The bags feature a flip back lid and a reinforced vinyl-wrapped body with perforated style panels that complement stock and many accessory seats. The bags are finished with nickel snap-to-close hardware and a black chrome Harley-Davidson signature medallion. Bags include all required mounting hardware, and can be installed with HoldFast™ sissy bars and racks when equipped with model-specific docking hardware. Luggage capacity: 2,170 cubic inches total

90201561A **\$799.95**

Fits '18-later FLSTL, FXBB, and FXLR models. Installation requires separate purchase of License Plate/Turn Signal Relocation Kit P/N 67800802 or 67800830.

B. H-D DETACHABLES LEATHER SADDLEBAGS – NOSTALGIC STYLE

These traditional throw-over style leather saddlebags are completely removable with the simple pull of the internal handle, leaving your bike clean and ready to cruise the boulevard. When removed, the bag leaves behind simple, inconspicuous docking points. Styled to complement the unique look of the stripped down Softail Slim® and Street Bob® models, these bags feature a leather tub and a reinforced lid that complement stock and many accessory seats. The traditional leather straps and the brass buckles and hardware add a distinctive retro look. Bags include all required mounting hardware, and can be installed with HoldFast sissy bars and racks when equipped with model-specific docking hardware. Luggage capacity: 2,170 cubic inches total.

90201552A **\$849.95**

Fits '18-later FLSTL, FXBB and FXLR models. Installation requires separate purchase of License Plate/Turn Signal Relocation Kit P/N 67800802 or 67800830.

Shown with:

REAR TURN SIGNAL/LICENSE PLATE RELOCATION KIT

Required for saddlebag installation on certain Softail models, these elegant sweeping mounts move the turn signals and the side-mount rearward on the fender struts, maintaining the stock lines. Available in chrome or gloss black to match the Original Equipment fender strut covers.

Fits '18-later FLFB, FLFBS, FLSTL, FXBB, FXFB, FXFBS, FXBR, FXBRS and FXLR models.

67800802 Chrome. **\$99.95**

67800830 Black. **\$99.95**



A. H-D DETACHABLES SADDLEBAGS



B. H-D DETACHABLES LEATHER SADDLEBAGS – NOSTALGIC STYLE

NOTE: Some Harley-Davidson® saddlebags are made of leather. Fine leathers or other natural materials WILL gain "character," such as wrinkles or wear, with age. This is normal. A fine, aged patina and character wrinkles are a sign of the extremely high quality materials used to construct your saddlebags. The appearance of scars or marks on the leather is a result of using natural leather panels and should not be thought of as an imperfection. Please use Harley-Davidson Leather Protectant P/N 93600034 to protect your investment.

Notice: The prices appearing in this catalog are the manufacturer's suggested retail prices. Actual retail prices may vary.

MILWAUKEE-EIGHT® SOFTAIL® 193

Saddlebags



**C. H-D DETACHABLES SADDLEBAGS – BRASS TRIM
(BREAKOUT MODEL SHOWN)**

C. H-D® DETACHABLES™ SADDLEBAGS – BRASS TRIM

Trimmed with classic valise straps, brass buckles and a matching brass Harley-Davidson® signature medallion, these bags are the perfect complement to your custom ride. These large-capacity lockable detachable saddlebags are completely removable with the simple pull of the internal handle, leaving your bike clean and ready to cruise the boulevard. When removed, the bags leave behind two simple, inconspicuous docking points. These handsome slant-style bags feature push-button latching swing-out lids that are easy to operate with one hand. The hard-shell design retains its shape in all kinds of weather, and the locking hinged lids offer modern convenience and security. Bags include all required mounting hardware, and can be installed with HoldFast™ sissy bars and racks when equipped with model-specific docking hardware.

90201645A **\$899.95**

Fits '18-later FLFB, FLFBS, FXBR and FXBRS models. Installation requires separate purchase of License Plate/Turn Signal Relocation Kit P/N 67800802 or 67800830. Luggage capacity: 2,840 cubic inches total.

90201644A **\$899.95**

Fits '18-later FLDE models. Luggage capacity: 2,970 cubic inches total.

D. H-D DETACHABLES LOCKING SADDLEBAGS

Shaped to complement the flowing lines of the Softail® cruiser models, these premium saddlebags feature a classic slant-style design with a modern twist. Wrapped in a combination of smooth and perforated-look vinyl, the hardshell bags will retain their shape in all kinds of weather. The hinged locking lid tilts outward for easy one-handed access. And when your trip is over, the bags can be removed with the simple turn of the internal lever, leaving behind nothing but inconspicuous docking points. Bags include all required mounting hardware, and can be installed with HoldFast™ sissy bars and racks when equipped with model-specific docking hardware.

90201555A **\$849.95**

Fits '18-later FLDE models. Luggage capacity: 2,970 cubic inches total.

90201513A **\$849.95**

Fits '18-later FLFB, FLFBS, FXBR and FXBRS models. Installation requires separate purchase of License Plate/Turn Signal Relocation Kit P/N 67800802 or 67800830. Luggage capacity: 2,840 cubic inches total.



D. H-D DETACHABLES LOCKING SADDLEBAGS – BREAKOUT SHOWN

NOTE: Some Harley-Davidson® saddlebags are made of leather. Fine leathers or other natural materials WILL gain "character," such as wrinkles or wear, with age. This is normal. A fine, aged patina and character wrinkles are a sign of the extremely high quality materials used to construct your saddlebags. The appearance of scars or marks on the leather is a result of using natural leather panels and should not be thought of as an imperfection. Please use Harley-Davidson Leather Protectant P/N 93600034 to protect your investment.

Notice: The prices appearing in this catalog are the manufacturer's suggested retail prices. Actual retail prices may vary.

194 MILWAUKEE-EIGHT® SOFTAIL®

Saddlebags

A. RIGID MOUNT SADDLEBAGS – SOFTAIL® DELUXE STYLING

These premium saddlebags are ready to go the distance. Styled to complement the Softail® Deluxe model's profile, these bags offer plenty of storage for a trip across town or across the country. The fine textured vinyl surface and black chrome medallion add an elegant touch, and the hard-shell body retains its shape in all kinds of weather. The push-button latching lids swing open with one hand for easy loading, and are lockable for added security. The bags are compatible with HoldFast™ accessories when installed with the appropriate docking hardware kits. Kit includes reflectors. Total luggage capacity: 2,510 cubic inches.

90201558 **\$799.95**
Fits '18-later FLDE models.



A. RIGID MOUNT SADDLEBAGS – SOFTAIL DELUXE STYLING

B. BLACK STANDARD LINE THROW-OVER SADDLEBAGS

Made of ultra-durable leather-like synthetic featuring a debossed H-D #1 logo, the Black Standard Line Bags have a simple, black on black style that complements many styling directions and budgets. An internal reinforcement system maintains the bag's shape over time. The "MOLLE-style" system of mounting loops accommodate hook and loop straps and allow for versatility in mounting. The bags feature matte black enamel buckles with hidden quick-detach buckles underneath. These Throw-Over bags feature side gussets for increased capacity and straight and perpendicular mounting loops for easy mounting. Quick-release buckles get you in and out of the bag fast. These Throw-Over Bags can be used with or without a passenger pillion. If used with a passenger pillion, the straps should be mounted under the pillion and the cross-over straps feature a soft, non-scratch backing. Installation requires purchase of saddlebag support rails and may require the purchase of a turn signal relocation kit. Large bag measures: 16.5" L x 11.5" H x 7" D. Internal capacity: 1,350CI. Weight capacity: 10 lbs./bag. Compact bag measures: 10" L x 11.5" H x 5.25" D. Internal capacity: 600CI. Weight capacity: 6 lbs./bag.

Fits '82-later XL (except 1200T), '08-'17 Dyna® (except FLD), '84-'99 Softail®, and '18-later Softail models equipped with H-D® Saddlebag Supports. '18-later Softail models require purchase of Turn Signal Relocation kit P/N 67800802 or 68700830.

90201770 Large. **\$269.95**
90201769 Compact. **\$219.95**

C. SADDLEBAG SUPPORTS – GLOSS BLACK

Keep your throw-over style saddlebags away from the wheel, swingarm and brake caliper. These Throw-Over Saddlebags feature gloss black hoops that attach to the upper shock mount and fender strut and can be installed on models equipped with rigid-mount sissy bar sideplates and upright.

90201777 **\$99.95**
Fits '18-later FLSL and FXBB models, required with Throw-Over Saddlebags P/Ns 90201770 or 90201769.



B. BLACK STANDARD LINE THROW-OVER SADDLEBAGS – LARGE



B. BLACK STANDARD LINE THROW-OVER SADDLEBAGS – COMPACT



C. SADDLEBAG SUPPORTS – GLOSS BLACK

NOTE: Some Harley-Davidson® saddlebags are made of leather. Fine leathers or other natural materials WILL gain "character," such as wrinkles or wear, with age. This is normal. A fine, aged patina and character wrinkles are a sign of the extremely high quality materials used to construct your saddlebags. The appearance of scars or marks on the leather is a result of using natural leather panels and should not be thought of as an imperfection. Please use Harley-Davidson Leather Protectant P/N 93600034 to protect your investment.

Notice: The prices appearing in this catalog are the manufacturer's suggested retail prices. Actual retail prices may vary.

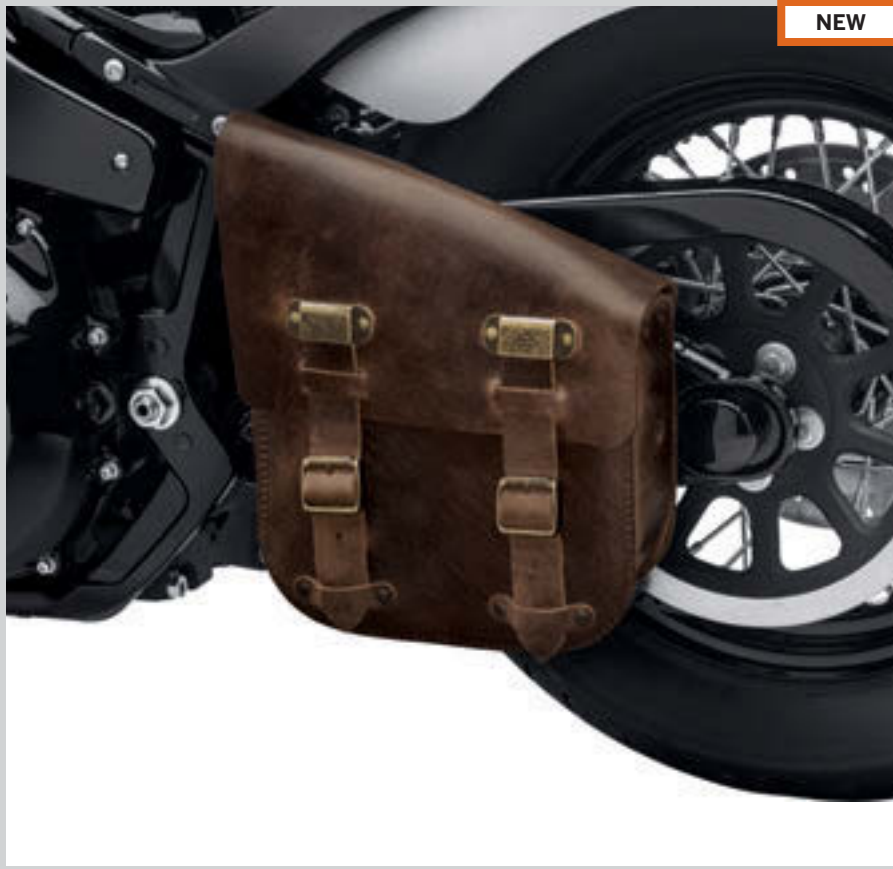

D. SINGLE-SIDED SWINGARM BAG – ANTIQUE BROWN LEATHER



D. SINGLE-SIDED SWINGARM BAG – BLACK LEATHER

NEW

MILWAUKEE-EIGHT® SOFTAIL® 195

Swingarm Bags

D. SINGLE-SIDED SWINGARM BAG

Less is more. With enough room for the essentials, these stylish Swingarm Bags eliminate the need to stuff your pockets or bungee a bag across the passenger pillion. Shaped to hug the contour of your bike's frame, these compact bags add an old-school look. Bags are constructed of heavyweight leather and feature a pouch-style flap lid that is secured with two traditional straps and buckles. The semi rigid-backed bag is secured to the left side of the bike with easy-to-install adjustable straps. Luggage capacity: 450 cubic inches total.

SINGLE SIDED SWINGARM BAG – ANTIQUE BROWN LEATHER

Crafted from supple brown pull-up leather, this classic Swingarm Bag will gain character and a well-worn authentic look with use. The flip-open lid is secured with traditional straps and buckles, and the bag features antique hardware that complements the old-school look.

90201568

\$219.95

Fits '00-later Softail® models (except FLSTC, FLSTNSE, FLSTSE, FXDRS, FXCW, and FXCWC). Does not fit models equipped with left hand tool box, passenger footboards, chrome swingarm covers, saddlebags, or saddlebag guards.

SINGLE SIDED SWINGARM BAG – BLACK LEATHER

Constructed with heavy boot-grade leather, this rich black Swingarm Bag is the perfect complement to any paint color or customizing style. The flip-open lid is secured with quick-disconnect clips hidden behind the traditional leather straps and brushed nickel-finished buckles.

90201567

\$219.95

Fits '00-later Softail models (except FLSTC, FLSTNSE, FLSTSE, FXDRS, FXCW, and FXCWC). Does not fit models equipped with left hand tool box, passenger footboards, chrome swingarm covers, saddlebags, or saddlebag guards.

SOFTAIL

NOTE: Some Harley-Davidson® saddlebags are made of leather. Fine leathers or other natural materials WILL gain "character," such as wrinkles or wear, with age. This is normal. A fine, aged patina and character wrinkles are a sign of the extremely high quality materials used to construct your saddlebags. The appearance of scars or marks on the leather is a result of using natural leather panels and should not be thought of as an imperfection. Please use Harley-Davidson Leather Protectant P/N 93600034 to protect your investment.

Notice: The prices appearing in this catalog are the manufacturer's suggested retail prices. Actual retail prices may vary.

196 MILWAUKEE-EIGHT® SOFTAIL®

Saddlebag Accessories

A. SADDLEBAG TRAVEL-PAKS – HERITAGE MODEL

Simplify packing and unpacking your motorcycle. Made from water resistant material these liners are designed to fit into the Original Equipment saddlebags on Heritage Classic models and Softail® Deluxe Rigid Mount Saddlebags P/N 90201558. The Travel Pak bags feature two-way zippers for easy access, and embossed Bar & Shield patches for style.

93300107 **\$59.95**

Fits '18-later FLHC and FLHCS models with Original Equipment saddlebags. Also fits FLDE models equipped with Softail Deluxe Rigid Mount Saddlebags P/N 90201558.

B. SADDLEBAG TRAVEL-PAKS – SPORT GLIDE® MODEL

Simplify packing and unpacking your motorcycle. These well-constructed water-resistant bags are designed to fit perfectly into the Sport Glide® model's saddlebags. The soft sides conform to the interior of the luggage to help use every available inch of space. Styled with a Bar & Shield logo, these bags feature heavy-duty zippers, comfortable carrying handles and convenient D-rings for optional shoulder straps.

93300110 **\$64.95**

Fits '18-later FLSB models.

C. TRANSPARENT PAINT GUARD KIT – SPORT GLIDE

This transparent skin is designed to protect your paint from bugs, boot scuffs and road debris. The crystal-clear material protects the paint without changing the overall look of your bike. And the optical properties of the material disguise minor scuffs and scratches. The application process is similar to that of tinted window film and the material can be removed and replaced when it is no longer cosmetically appealing. Scratches to paint can be expensive to repair but scratches to this film can be removed by applying a small amount of heat with a heat gun.

Fits '18-later FLSB models. Not recommended for use on denim or aftermarket paint.

11100225 Fairing. **\$84.95**

11100222 Saddlebags. **\$69.95**



A. SADDLEBAG TRAVEL-PAKS – HERITAGE MODEL



B. SADDLEBAG TRAVEL-PAKS – SPORT GLIDE MODEL



C. TRANSPARENT PAINT GUARD KIT – FAIRING

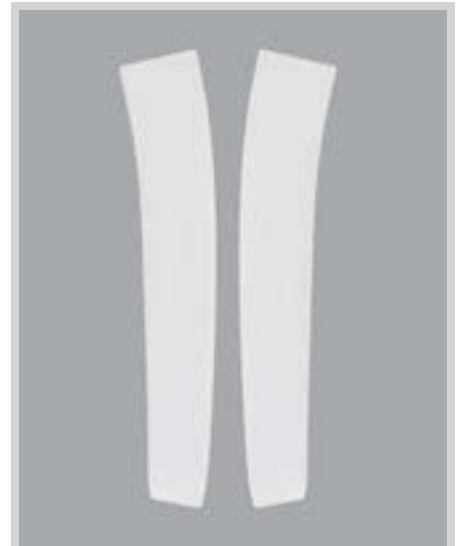

C. TRANSPARENT PAINT GUARD KIT – SADDLEBAGS

Notice: The prices appearing in this catalog are the manufacturer's suggested retail prices. Actual retail prices may vary.

MILWAUKEE-EIGHT® SOFTAIL® 197

Tour-Pak® Luggage

TOUR-PAK® LUGGAGE

When you're serious about racking up the miles, Tour-Pak® luggage systems allow you to pack everything you need for a cross-country trip or a run to the grocery store. Each style of Tour-Pak Luggage features a lockable lid and a matching backrest pad. And, when you arrive at your destination, the Tour-Pak and its HoldFast™ Mounting Rack can be removed in seconds to return your bike to a stripped-down profile. Each Tour-Pak has a capacity of 2,580 cubic inches (enough to fit one full face helmet or two half helmets) and measures 18.5" W x 18.75" D x 12.25" H. Mounting racks and docking kits are sold separately.

Fits '18-later FLDE, FLHC, FLHCS, FLSB, FLSL and FXBB models equipped with HoldFast Detachable Solo or Two-Up Tour-Pak Mounting Rack.

D. TOUR-PAK LUGGAGE – HERITAGE STYLE

Accented with twin rows of blacked-out rectangular studs, this Tour-Pak is the perfect match for the seats and saddlebags on your Heritage Softail®.

53000598

\$674.95

E. TOUR-PAK LUGGAGE – SMOOTH VINYL

Styled to complement a wide variety of Softail® seats and saddlebags and features fine-grain texturing with perforated side panels.

53000570

\$674.95

F. TOUR-PAK LUGGAGE – CLASSIC LEATHER

Finished with traditional valise straps and brass buckles and hardware, this Tour-Pak is the perfect companion to the brass-trimmed saddlebags available for your nostalgic Harley-Davidson® model.

53000599

\$724.95

HOLDFAST™ DETACHABLE TOUR-PAK LUGGAGE MOUNTING RACK

Harley-Davidson HoldFast docking hardware allows you to transform your ride in the blink of an eye. Switch from a comfortable passenger backrest to load-hauling Tour-Pak luggage in seconds. You can easily remove the Tour-Pak luggage for easy maneuverability around town and reinstall it for an epic ride across the country. Tour-Pak Luggage and model-specific Docking Hardware Kits sold separately.

G. HOLDFAST SOLO TOUR-PAK LUGGAGE MOUNTING RACK

The Solo Tour-Pak Mounting Rack moves the Softail Tour-Pak luggage forward to a comfortable rider-supporting position. Designed for use with a solo seat this Rack positions the Tour-Pak luggage over the fender to serve as a backrest for the rider. Tour-Pak can be repositioned forward or aft over a .75" range to maximize rider space. Simple fingertip operated latches release the rack from the docking hardware for easy removal.

Fits '18-later FLDE, FLHC, FLHCS, FLSL and FXBB models equipped with a solo seat. Installation requires separate purchase of model-specific Docking Hardware Kit.

53000174 Chrome.

\$189.95

53000176 Gloss Black.

\$189.95

H. HOLDFAST TWO-UP TOUR-PAK MOUNTING RACK

With the HoldFast Two-Up Tour-Pak Mounting Rack, you can change your riding style in seconds. With a simple pull of the HoldFast latches, you can convert your bike from a touring machine with a Tour-Pak to a street cruiser with a detachable sissy bar upright. When using a Tour-Pak, the rack is adjustable over a .75" range, allowing the Tour-Pak to be located for maximum passenger room and comfort.

Fits '18-later FLDE, FLHC and FLHCS models equipped with a two-up seat. Installation requires separate purchase of model specific Docking Hardware Kit. FLHC and FLHCS models with oversize international registration plates may interfere with Luggage Rack and may require separate purchase of License Plate Relocation Kit P/N 67900472.

53000186 Chrome.

\$199.95

53000188 Gloss Black.

\$199.95

Fits '18-later FLSB models equipped with a two-up seat. Installation requires separate purchase of model-specific Docking Hardware Kit.

53000192 Gloss Black.

\$199.95

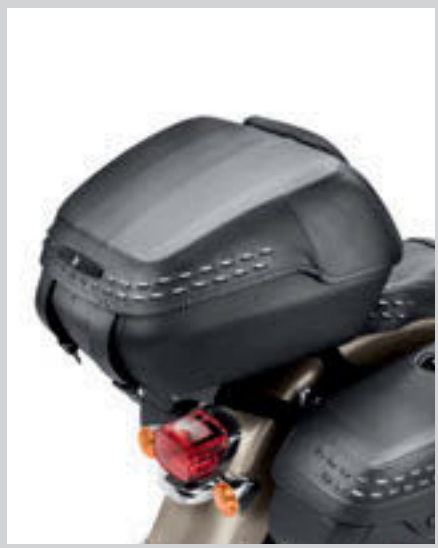

D. TOUR-PAK LUGGAGE – HERITAGE STYLE



E. TOUR-PAK LUGGAGE – SMOOTH VINYL

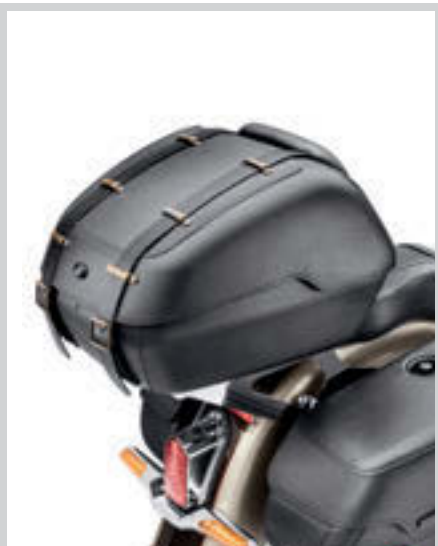

F. LEATHER TOUR-PAK LUGGAGE – CLASSIC LEATHER



G. HOLDFAST SOLO TOUR-PAK LUGGAGE MOUNTING RACK – GLOSS BLACK

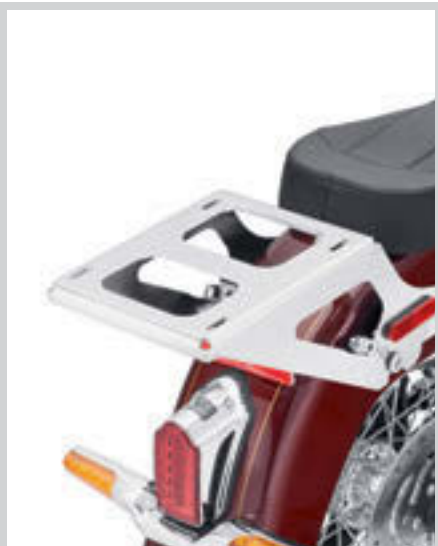

H. HOLDFAST TWO-UP TOUR-PAK MOUNTING RACK – CHROME



H. HOLDFAST TWO-UP TOUR-PAK MOUNTING RACK – GLOSS BLACK (FLSB MODEL SHOWN)

NEW

SOFTAIL

Notice: The prices appearing in this catalog are the manufacturer's suggested retail prices. Actual retail prices may vary.

198 MILWAUKEE-EIGHT® SOFTAIL®

Suspension

A. PROFILE® LOW FRONT SUSPENSION*

Designed by Harley-Davidson and Showa, this kit reduces the front fork length by over 1.0". This Profile® Low front suspension utilizes dual bending valve technology to preserve original ride quality. Springs are wound to allow a compliant, yet controlled ride. A perfect addition during the installation of chrome or gloss black lower fork sliders, the kit includes two fork springs, two damper tubes, seals and hardware.

45500427 **\$129.95**

Fits '18-later FLDE, FLHC, FLHCS, FLSL, FXBB, and FXLR models. FLDE model requires separate purchase of Jiffy Stand P/N 50000156. FXBB models require separate purchase of Jiffy Stand P/N 50000127. FLHC and FLHCS models must be equipped with Profile Low Rear Suspension P/N 54000134 and requires separate purchase of Jiffy Stand P/N 50000156.

B. PROFILE LOW REAR SUSPENSION*

This suspension lowers the seat height approximately .75" while preserving ride quality. Spring and damping rates are tailored to ensure a controlled ride. Shock features multi-staged damping to ensure optimal performance under varying conditions. The pre-load adjuster allows easy access for setting proper sag according to rider's weight for optimal comfort. Kit includes one rear shock absorber.

54000134 **\$389.95**

Fits '18-later FLHC and FLHCS models. Installation requires separate purchase of Jiffy Stand P/N 50000127 if not equipped with Profile Low Front Suspension P/N 45500427.

54000143 **\$389.95**

Fits '18-later FXFB and FXFBS models. Installation requires separate purchase of Jiffy Stand P/N 50000127.



A. PROFILE LOW FRONT SUSPENSION



B. PROFILE LOW REAR SUSPENSION



***WARNING:** Installation of any accessory suspension components may affect cornering clearance and jiffy stand operation. This could distract the rider, causing loss of control and death or serious injury.



***WARNING:** The Profile Low Front Spring Kit cannot be used independently and must be used with the appropriate Profile Rear Shock Lowering Kit. Installation of any accessory suspension components may affect cornering clearance and jiffy stand operation. This could distract the rider, causing loss of control and death or serious injury.

Notice: The prices appearing in this catalog are the manufacturer's suggested retail prices. Actual retail prices may vary.



C. MID CONTROL MOUNTS



C. MID CONTROL MOUNTS – CHROME



D. STANDARD FORWARD CONTROL MOUNTS – CHROME



E. RIDER FOOTBOARD MOUNTS – CHROME

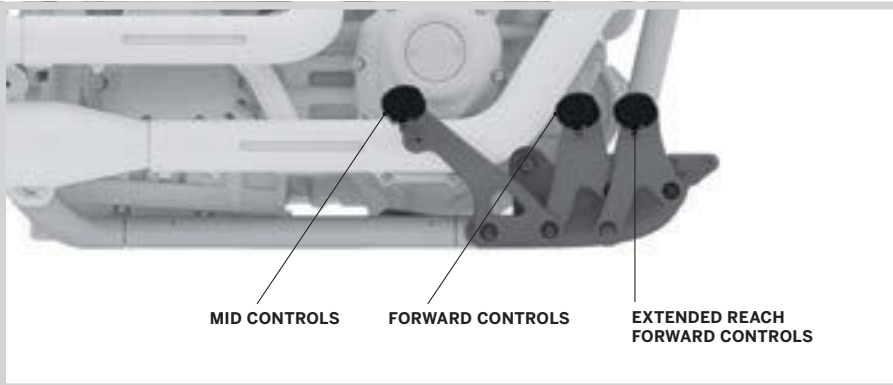

MID CONTROLS FORWARD CONTROLS EXTENDED REACH FORWARD CONTROLS

F. EXTENDED REACH FORWARD CONTROL KIT



F. EXTENDED REACH FORWARD CONTROL KIT



F. EXTENDED REACH FORWARD CONTROL KIT

MILWAUKEE-EIGHT® SOFTAIL® 199

Foot Controls

C. MID CONTROL MOUNTS – CHROME

Add a touch of style by replacing the stock painted foot control brackets with brilliant chrome. Polished and plated for a custom look, this kit is manufactured with Original Equipment components for proper fit. Kit includes left and right supports and chrome mounting hardware.

50500691 **\$199.95**
Fits '18-later FXBB and FXLR models with mid controls.

D. STANDARD FORWARD CONTROL MOUNTS – CHROME

This kit replaces the factory painted forward control mounts with brilliant chrome. Finished to complement chrome or polished foot pegs and levers, these supports are manufactured from Original Equipment components for proper fit. Kit includes left and right supports and chrome mounting hardware.

50500693 **\$199.95**
Fits '18-later FXFB, FXFBS, FLSB, FXBR and FXBRS models with forward controls.

E. RIDER FOOTBOARD MOUNTS – CHROME

Complete the custom transformation by replacing the stock painted footboard brackets with brilliant chrome. The perfect complement to custom footboards, this kit is manufactured with Original Equipment components for proper fit, and are polished and plated to a brilliant finish. Kit includes chrome mounting hardware.

50500695 **\$249.95**
Fits '18-later FLDE, FLHC, FLHCS and FLSSL models with rider footboards.

50500696 **\$249.95**
Fits '18-later FLFB and FLFBS models with rider footboards.

F. EXTENDED REACH FORWARD CONTROL KIT*

Stretch out in the saddle. This kit extends the rider foot controls a full 3.0" forward of the stock location, providing the tall rider a comfortable riding position. This comprehensive kit includes everything necessary for installation. Kit includes new black painted brake and shifter mounting assemblies, extended shift rod, brake line and all necessary hardware. The kit is compatible with Original Equipment or accessory foot-pegs, brake and shift levers and brake pedal pad and shifter peg.

50500840 **\$569.95**
Fits '18-later FXBR and FXBRS models with ABS. Not compatible with Engine Guards.

50500839 **\$569.95**
Fits '18-later FXFB and FXFBS models without ABS. Not compatible with Engine Guards.

50500837 **\$569.95**
Fits '18-later FLSB, FXFB and FXFBS models with ABS. Not compatible with Engine Guards.



***WARNING:** Installation of this kit may affect cornering clearance. This could distract the rider, causing loss of control, resulting in death or serious injury.

Notice: The prices appearing in this catalog are the manufacturer's suggested retail prices. Actual retail prices may vary.

200 MILWAUKEE-EIGHT® SOFTAIL®

Foot Controls

A. BILLET STYLE REAR BRAKE LEVER – FORWARD CONTROLS

Styled to complement our billet style mirror stems and hand and foot controls, these slotted Rear Brake Levers are forged from aluminum, then machined and polished for a beautiful, custom look. Available in your choice of mirror chrome, satin black powder coat or edge cut black anodized and machined aluminum finishes. Brake pedal pads sold separately.

Fits '18-later Softail® models equipped with forward controls.

41600218	Chrome.	\$179.95
41600219	Satin Black.	\$179.95
41600220	Edge Cut.	\$179.95



A. BILLET STYLE REAR BRAKE LEVER – FORWARD CONTROLS – CHROME



A. BILLET STYLE REAR BRAKE LEVER – FORWARD CONTROLS

B. BILLET STYLE REAR BRAKE LEVER – FOOTBOARD

These Billet Style Rear Brake Levers are forged from billet aluminum, then machined and polished for a beautiful, custom look. Available in your choice of mirror chrome, satin black powder coat or edge cut black anodized and machined aluminum finishes. Lever matches the length of the Original Equipment lever found on FL Softail motorcycles. Brake pedal pads sold separately.

Fits '18-later FL Softail models equipped with footboards.

41600215	Chrome.	\$179.95
41600216	Satin Black.	\$179.95
41600217	Edge Cut.	\$179.95



B. BILLET STYLE REAR BRAKE LEVER – FOOTBOARD – CHROME



B. BILLET STYLE REAR BRAKE LEVER – FOOTBOARD

C. BILLET STYLE SHIFT LEVERS – FORWARD CONTROLS

Forged from aluminum, these Billet Style Shift Levers are machined and polished for a beautiful, custom look. Available in your choice of mirror chrome, satin black powder coat or edge cut black anodized and machined aluminum finishes. Includes chrome hardware. Shifter pegs sold separately.

Fits '18-later FLSB, FXDRS, FXFB, FXFBS, FXBR and FXBRS models equipped with forward controls and '18-later FLDE, FLFB, FLFBC, FLHC, FLHCS and FLSL models equipped with footboards.

33600167	Chrome.	\$99.95
33600168	Satin Black.	\$99.95
33600169	Edge Cut.	\$99.95



C. BILLET STYLE REAR SHIFT LEVER – FORWARD CONTROLS – CHROME



C. BILLET STYLE REAR SHIFT LEVER – FORWARD CONTROLS

D. BILLET STYLE HEEL/TOE SHIFT LEVER

Add a traditional heel-toe shift action and a contemporary new look. These Billet Style Shift Levers are forged from aluminum, then machined and polished for a beautiful, custom finish. Available in your choice of mirror chrome, satin black powder coat or edge cut black anodized and machined aluminum finishes. Kit includes a front and rear lever and chrome hardware.

Fits '18-later FLDE, FLFB, FLFBS, FLHC, FLHCS and FLSL models equipped with footboards.

33600164	Chrome.	\$159.95
33600165	Satin Black.	\$159.95
33600166	Edge Cut.	\$159.95



D. BILLET STYLE HEEL/TOE SHIFT LEVER – CHROME



D. BILLET STYLE HEEL/TOE SHIFT LEVER

Notice: The prices appearing in this catalog are the manufacturer's suggested retail prices. Actual retail prices may vary.

MILWAUKEE-EIGHT® SOFTAIL® 201

Foot Controls



E. HEEL SHIFTER LEVER

E. HEEL SHIFTER LEVER

Add the convenience of a heel shifter to your footboard-equipped Softail® model. This traditional Heel Shifter Lever permits you to upshift with a downward tap of your boot heel – eliminating the need to wedge your toe under the forward lever and reducing wear on the top of your boot. Styled to match the Original Equipment toe shifter, this easy to install kit includes the chrome-plated heel shift lever, extended shifter shaft, shifter peg and mounting hardware.

33600224 **\$84.95**
Fits '18-later FL Softail® models equipped with footboards.

F. CUSTOM GEAR SHIFT LINKAGE – ROUND GLOSS BLACK

Add the finishing touch to your blacked-out ride. This Gloss Black Shift Linkage is easy to install and includes a transmission lever cover and decorative acorn nuts and bolts for a complete custom look.

33600259 **\$99.95**

Fits '86-later Softail (except '18-later FXBB and FXLR), Touring and Trike models. (Does not fit '97-'99 FLSTS or models equipped with Softail Extended Reach Forward Controls.)



F. CUSTOM GEAR SHIFT LINKAGE – ROUND GLOSS BLACK

G. CUSTOM GEAR SHIFT LINKAGES

Kick your custom into gear with this collection of high quality custom shift linkages. Available in a variety of designs to match your bike's style, these linkages feature aircraft-quality rod ends for easy adjustment and smooth operation. The easy-to-install linkage kit also includes a transmission lever cover for '86-'17 Softail and '86-'16 Touring and Trike models, and decorative acorn nuts and bolts for a complete custom look.

Fits '86-later Softail, (except '18-later FXBB and FXLR), Touring and Trike models. (Does not fit '97-'99 FLSTS or models equipped with Softail Extended Reach Forward Controls.)

1. 34018-08	Slotted Black Anodized.	\$129.95
2. 34850-09	Skull.	\$129.95
3. 33801-09	Harley-Davidson Script.	\$129.95
4. 33760-09	Slotted with Bar & Shield Logo.	\$129.95
5. 33814-98A	Round.	\$89.95



G. CUSTOM GEAR SHIFT LINKAGES

Notice: The prices appearing in this catalog are the manufacturer's suggested retail prices. Actual retail prices may vary.

202 MILWAUKEE-EIGHT® SOFTAIL®

Foot Controls

A. PASSENGER FOOTPEG SUPPORT KIT

Add footpeg to your solo seat-equipped '18-later Softail® motorcycle. Available in chrome or gloss black finish, the kit includes left and right footpeg supports and mounting hardware. Footpegs and footpeg hardware sold separately.

Fits '18-later Softail (except FXDRS) models.

50500769	Gloss Black.	\$99.95
50500771	Chrome.	\$149.95



A. PASSENGER FOOTPEG SUPPORT KIT – GLOSS BLACK



A. PASSENGER FOOTPEG SUPPORT KIT – CHROME

B. PASSENGER FOOTBOARD SUPPORT

Add the comfort and convenience of passenger footboard to your motorcycle. These brackets and supports are designed to allow installation of Passenger Footboards (sold separately). Brackets and Supports are sold separately.

Fits '18-later Softail models equipped with Passenger Footboard Support Kit P/N 50501117 or P/N 50501118. Requires separate purchase of Passenger Footboard Adapter Kit and Passenger Footboards.

50501114	Black.	\$149.95
50501113	Chrome.	\$149.95



B. PASSENGER FOOTBOARD SUPPORT – CHROME



B. PASSENGER FOOTBOARD SUPPORT – BLACK

C. PASSENGER FOOTBOARD SUPPORT BRACKET

Add the comfort and convenience of passenger footboard to your motorcycle. These brackets and supports are designed to allow installation of Passenger Footboards (sold separately). Brackets and Supports are sold separately.

50501118 Black. **\$99.95**
Fits '18-later FLDE, FLHC, FLCS and FLSB models. Requires separate purchase of Passenger Footboard Supports and Passenger Footboards.

50501117 Black. **\$99.95**
Fits '18-later FLFB, FLFBS, FLFL, FXBB, FXBR, FXBRS and FXLR models. Requires separate purchase of Passenger Footboard Supports and Passenger Footboards.



C. PASSENGER FOOTBOARD SUPPORT BRACKET (50501118 SHOWN)



C. PASSENGER FOOTBOARD SUPPORT BRACKET (50501117 SHOWN)

D. PASSENGER FOOTPEG MOUNTING KIT

A necessary addition when converting your solo seat FXDR 114 model to a two-up passenger-carrying ride. Kit includes black mounting adapters and brackets (footpegs sold separately).

50501128 Black. **\$179.95**
Fits '19-later FXDRS models.



D. PASSENGER FOOTPEG MOUNTING KIT

Notice: The prices appearing in this catalog are the manufacturer's suggested retail prices. Actual retail prices may vary.

MILWAUKEE-EIGHT® SOFTAIL® 203

Engine Guards



E. MUSTACHE ENGINE GUARD – CHROME



E. MUSTACHE ENGINE GUARD – GLOSS BLACK



F. ENGINE GUARD KIT – CHROME



F. ENGINE GUARD KIT – GLOSS BLACK



G. SADDLEBAG GUARDS – CHROME



G. SADDLEBAG GUARDS – BLACK



E. MUSTACHE ENGINE GUARD*

Combine classic shape and modern function for a unique twist on engine protection. The flow of this engine guard complements the bike's traditional style while the gracefully curved upper section incorporates highway pegs into the shape. The integrated rubber pads offer a comfortable and slip-resistant cushion for your feet while traveling the open road. One-piece engine guard kit includes all required mounting hardware.

Fits '18-later Softail® (except FXDRS) models. Does not fit with Extended Reach Forward Control Kits.

49000140 Chrome. **\$279.95**

49000141 Gloss Black. **\$279.95**

F. ENGINE GUARD KIT*

Protect your bike without sacrificing ground clearance or style. The one-piece Engine Guard is designed to complement the lines of the motorcycle and the available chrome or gloss black finish adds the perfect finishing touch.

Fits '18-later Softail (except FXDRS) models. Does not fit with Extended Reach Forward Control Kits.

49000138 Chrome. **\$219.95**

49000139 Gloss Black. **\$219.95**

G. SADDLEBAG GUARDS

Saddlebag guards provide a style borrowed from the past that makes a unique statement here and now. Includes mounting hardware and instructions.

Fits '18-later FLHC and FLHCS models.

90201312 Chrome. **\$249.95**

90201315 Black. **\$249.95**



***WARNING:** Engine guards may provide limited leg and cosmetic vehicle protection under unique circumstances (fall over while stopped, very low speed slide). They are not made nor intended to provide protection from bodily injury in a collision with another vehicle or any other object.



***WARNING:** Do not use engine guard footpegs under normal stop and go operating conditions. Doing so could result in death or serious injury.

Notice: The prices appearing in this catalog are the manufacturer's suggested retail prices. Actual retail prices may vary.

204 MILWAUKEE-EIGHT® SOFTAIL®

Chassis Trim – Front End

A. LOWER FORK SLIDERS – CHROME

Competitively-priced, these chrome-plated Lower Fork Sliders give your bike upfront style. To ensure proper fitment and function, these sliders are manufactured from Original Equipment components. Form follows function, with polished, chrome-plating and a stamped Harley-Davidson logo for product identification. A perfect addition during the installation of Profile® Low Front suspension components, this kit includes right and left sliders, bottom axle retainer, axle retainer bolts and oil seals.

45500400 **\$449.95**
Fits '18-later FLDE, FLHC, FLHCS and FLSL models.

45500399 **\$449.95**
Fits '18-later FXBR and FXBRS models.

45500406 **\$449.95**
Fits '18-later FXLR models.

45500401 **\$449.95**
Fits '18-later FXBB models.

45500402 **\$449.95**
Fits '18-later FLFB and FLFBS models.

B. LOWER FORK SLIDERS – GLOSS BLACK

These gloss black coated sliders are the ultimate extension of your bike's dark side and make a perfect custom addition to your blacked-out Softail® model. Manufactured to Original Equipment specifications, the durable black coating is a great match to other H-D® black components. A perfect addition during the installation of Profile® Low Front suspension components, this includes right and left sliders, bottom axle retainers, drain screws, axle retainer bolts and oil seals.

45500403 **\$449.95**
Fits '18-later FLDE, FLHC, FLHCS and FLSL models.

45500404 **\$449.95**
Fits '18-later FLFB and FLFBS models.

45500405 **\$449.95**
Fits '18-later FXLR models.



A. LOWER FORK SLIDERS – CHROME
(45500400 SHOWN)



B. LOWER FORK SLIDERS – GLOSS BLACK
(45500403 SHOWN)

Notice: The prices appearing in this catalog are the manufacturer's suggested retail prices. Actual retail prices may vary.

MILWAUKEE-EIGHT® SOFTAIL® 205

Chassis Trim – Front End



NEW

C. FAT BOY NACELLE KIT – CHROME



NEW

C. FAT BOY NACELLE KIT – GLOSS BLACK (SHOWN WITH BLACK HEADLAMP BEZEL)

C. FAT BOY® NACELLE KIT

Take your Fat Boy® model in a new styling direction. Manufactured from Original Equipment components for a perfect fit, these Nacelle Kits are a direct replacement for the stock satin chrome nacelle. Available in mirror chrome or gloss black finishes, these kits are just the start on your journey to build a one-of-a-kind custom ride. Add matching lower fork sliders, upper fork slider covers and axle nut covers to complete the conversion. The 3-piece kit includes nacelle housing and two back panels. Black Headlamp Bezel P/N 61400509 is sold separately.

Fits '18-later FLFB and FLFBS models.

61300817	Chrome.	\$299.95
61300811	Gloss Black.	\$299.95

D. FAT BOY NACELLE HEADLAMP BEZEL – GLOSS BLACK

Complete the transition to the dark side. This gloss black Headlamp Bezel replaces the Original Equipment chrome bezel, and is the perfect match for the Fat Boy Nacelle Kit P/N 61300811.

61400509		\$64.95
-----------------	--	----------------

Fits '18-later FLFB and FLFBS models.

E. UPPER FORK SLIDER COVERS – CHROME

Brilliant chrome accents for the upper fork legs. Perfect for finishing off that chromed front end look. When used with H-D® Genuine Motor Accessory Chrome Lower Fork Sliders, you've got a front end that's completely chromed and an appearance that's utterly impressive. Kit includes left and right cover.

45800133	Chrome.	\$84.95
-----------------	---------	----------------

Fits '18-later FLFB and FLFBS models.

UPPER FORK SLIDER COVERS – GLOSS BLACK

The classic Harley-Davidson® motorcycle color is black. It shows your attitude, your feelings and your desire to be different from the rest. When combined with matching Lower Fork Sliders, these Gloss Black Upper Fork Slider Covers complete the blacked-out transformation. Manufactured from Original Equipment components for superior fit, the black finish matches the available black fork sliders and nacelle kit for a unified look. Kit includes left and right cover.

45800134	Gloss Black.	\$84.95
-----------------	--------------	----------------

Fits '18-later FLFB and FLFBS models.

UPPER FORK SLIDER COVERS – MACHINE CUT

Add an edgy look to your front forks. These forged aluminum one-piece covers are finished in rich black and machined to expose the raw aluminum. The resulting contrast complements both traditional and contemporary customizing styles, and looks great alongside Defiance and Edge Cut accessories.

45800135		\$199.95
-----------------	--	-----------------

Fits '18-later FLDE, FLHC and FLHCS models.

F. OIL COOLER COVER

Dress the oil cooler in style. The cover fills the area between the frame downtubes for a complete custom look, without disturbing the airflow across the cooler's surface. This Oil Cooler Cover replaces the plastic surround, and because it hugs the contours of the cooler body, it does not interfere with engine guard installation. Available in your choice of chrome or gloss black finish, the easy-to-install cover kit includes all required mounting hardware.

Fits '18-later Softail models.

62500026	Chrome.	\$84.95
62500027	Gloss Black.	\$84.95



NEW

D. FAT BOY NACELLE HEADLAMP BEZEL – GLOSS BLACK



NEW

E. UPPER FORK SLIDER COVERS – CHROME



NEW

E. UPPER FORK SLIDER COVERS – GLOSS BLACK



NEW

E. UPPER FORK SLIDER COVERS – MACHINE CUT



F. OIL COOLER COVER KIT – CHROME



F. OIL COOLER COVER KIT – GLOSS BLACK

SOFTAIL

Notice: The prices appearing in this catalog are the manufacturer's suggested retail prices. Actual retail prices may vary.

206 MILWAUKEE-EIGHT® SOFTAIL®

Chassis Trim – Front End

FRONT AXLE NUT COVERS

Cover the front axle in style. Available in your choice of styles, these custom Axle Nut Covers look great with Original Equipment satin-finish fork sliders or add the finishing touch to a complete chrome or blacked-out front end. Easy to install kits include all necessary mounting hardware. Sold in pairs.

Fits '02-'11 VRSC™ (except VRSCF and VRSCR), '15-later XG, '08-later XL, '08-'17 Dyna®, '07-later Softail® (except Springer™, FLSTNSE, FXCW, FXCWC, FXSB, FXSBSE, FXSE, FXST-Aus, and FXSTD) and '08-later Touring and Trike models. '18-later FLDE, FLFB, FLFBS, FLHC, FLHCS, FLSE, FLSEB, FLSEB, FXBR, FXBRS and FXLR models require separate purchase of Front Axle Adapter Kit P/N 43000090. '19-later FXDRS and '18-later FXFB and FXFBS models require separate purchase of Front Axle Adapter Kit P/N 43000159.

A. DOMINION™ COLLECTION FRONT AXLE NUT COVERS

Express your bold, renegade attitude. The machined aluminum Dominion™ Collection Front Axle Nut Covers add style to the front of the bike and are the perfect complement to other Dominion Collection accessories.

43000124	Gloss Black.	\$74.95
43000123	Bronze.	\$74.95

B. DEFIANCE COLLECTION FRONT AXLE NUT COVERS

Start a new tradition. Deep radial grooves and a contemporary H-D logo define the style Defiance Collection Front Axle Nut Covers. Available in your choice of chrome or black machine cut finish, these easy to install elements complement polished, chrome or blacked-out front end components. Sold in pairs.

43000062	Chrome.	\$74.95
43000064	Black Machine Cut.	\$74.95

C. CHROME FRONT AXLE NUT COVERS

44117-07A	Die-cast.	\$29.95
44116-07A	Billet.	\$44.95

D. GLOSS BLACK FRONT AXLE NUT COVERS

43000026	Die-cast.	\$29.95
43428-09	Billet.	\$44.95

E. ALUMINATOR® FRONT AXLE NUT COVERS

Chrome-plated billet aluminum axle covers feature a classic Bar & Shield logo insert. Includes all necessary mounting hardware for easy installation.

44114-07		\$44.95
-----------------	--	----------------

F. FRONT AXLE NUT COVERS – SATIN CHROME

Cover the front axle in style. The rich satin chrome finish of these Front Axle Covers is the perfect match for the satin-finished components on the '18 Fat Boy® model, and a great complement to Original Equipment polished or blacked-out fork sliders as well. Easy to install kits include all necessary mounting hardware. Sold in pairs.

43000098		\$29.95
-----------------	--	----------------



A. DOMINION FRONT AXLE NUT COVERS – GLOSS BLACK



A. DOMINION FRONT AXLE NUT COVERS – BRONZE



B. DEFIANCE COLLECTION FRONT AXLE NUT COVERS – CHROME



B. DEFIANCE COLLECTION FRONT AXLE NUT COVERS – BLACK MACHINE CUT



C. CHROME FRONT AXLE NUT COVERS



D. GLOSS BLACK FRONT AXLE NUT COVERS



E. ALUMINATOR FRONT AXLE NUT COVERS



F. SATIN CHROME FRONT AXLE NUT COVERS

Notice: The prices appearing in this catalog are the manufacturer's suggested retail prices. Actual retail prices may vary.



G. H-D MOTOR CO. LOGO FRONT AXLE NUT COVERS



H. BURST COLLECTION FRONT AXLE NUT COVERS



I. WILLIE G SKULL FRONT AXLE NUT COVERS – BLACK



I. WILLIE G SKULL FRONT AXLE NUT COVERS – CHROME



J. BRASS COLLECTION FRONT AXLE NUT COVERS



K. FRONT AXLE NUT COVERS INSTALLATION KITS

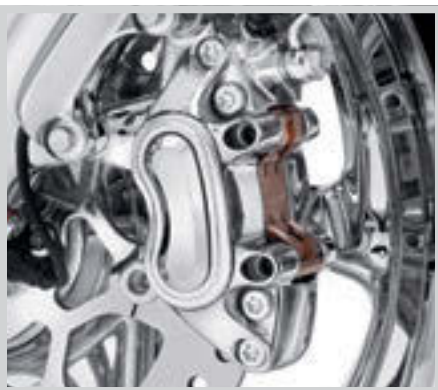

L. FRONT BRAKE CALIPER KIT – CHROME (SHOWN WITH CLASSIC CHROME CALIPER INSERT)



L. FRONT BRAKE CALIPER KIT – RED

MILWAUKEE-EIGHT® SOFTAIL® 207

Chassis Trim – Front End

G. H-D MOTOR CO. LOGO FRONT AXLE NUT COVERS

Die-cast, chrome-plated covers feature the Harley-Davidson Motor Co. logo in black. Includes Allen®-head set screws and wrench for easy installation.

44148-07A \$31.95

H. BURST COLLECTION FRONT AXLE NUT COVERS

Finish your blacked-out forks in style. Rich black and prismatic machined surfaces provide the contrast and the race-track ridges and the inner spider design make a powerful visual statement. Easy to install kit includes mounting hardware.

43000031 \$69.95

I. WILLIE G SKULL FRONT AXLE NUT COVERS

Penned at the hand of Willie G, the famous Skull Collection adds a little attitude to your ride. Completely drenched in black or chrome with black filled accents, the raised skull and surrounding Harley-Davidson Motorcycle script adds a subtle ominous touch to your ride. The Axle Nut Covers are easy to install and include all necessary mounting hardware. Sold in pairs.

Fits '02-'11 VRSC™ (except VRSCF and VRSCR), '15-later XG, '08-later XL (except '16-later XL1200X and XL1200XS), '08-'17 Dyna®, '07-later Softail® (except Springer™, FLSTNSE, FXCW, FXCWC, FXSB, FXSBSE, FXSE, FXST-Aus, and FXSTD) and '08-later Touring and Trike models. '18-later FLDE, FLFB, FLFBS, FLHC, FLHCS, FLSL, FXBB, FXBR, FXBRS and FXLR models require separate purchase of Front Axle Adapter Kit P/N 43000090. '19-later FXDRS and '18-later FXFB and FXFBS models require separate purchase of Front Axle Adapter Kit P/N 43000159.

43000096 Black. \$34.95

43163-08A Chrome. \$34.95

J. FRONT AXLE NUT COVERS – BRASS COLLECTION

Cover the front axle in style. Artistically manufactured from solid brass, these components feature a natural antique finish that will age and patina when exposed to the elements. Brass Collection Axle Nut Covers look great with Original Equipment satin-finish fork sliders or as the finishing touch to a blacked-out front end. Easy to install kits include all necessary mounting hardware. Sold in pairs.

43000046 \$54.95

Fits '02-'11 VRSC (except VRSCF and VRSCR), '15-later XG, '08-later XL (except '16-later XL1200X and XL1200XS), '08-'17 Dyna, '07-later Softail (except Springer, FLSTNSE, FLFB, FXCW, FXCWC, FXDRS, FXFB, FXFBS, FXSB, FXSBSE, FXSE, FXST-Aus, and FXSTD) and '08-later Touring and Trike models. FLDE, FLFB, FLFBS, FLHC, FLHCS, FLSL, FXBB, FXBR, FXBRS and FXLR models require separate purchase of Front Axle Adapter Kit P/N 43000090.

K. FRONT AXLE COVER INSTALLATION KIT

Required for installation of accessory Front Axle Covers on '18-later Softail models. Kit includes threaded axle spacer, left and right adapters and all hardware.

43000090 Hollow-axle. \$19.95

Required for installation of Front Axle Nut Covers on '18-later Softail models. Does not fit FXDRS, FXFB, and FXFBS models.

43000159 Inverted Forks. \$19.95

Required for installation of Front Axle Nut Covers on '19-later FXDRS and '18-later FXFB and FXFBS.

L. BRAKE CALIPER KIT – FRONT, SINGLE DISC

Manufactured from Original Equipment components for proven performance, these calipers will add a stylish touch to the stock bike or add the perfect finish to a complete custom equipped with chrome or blacked-out wheels, rotors and fork sliders.

Fits '15-later Softail models (except FXDRS, FXFB, FXFBS, FXSE). Kit includes brake pads.

41300148 Chrome. \$399.95

41300152 Red. \$249.95

Notice: The prices appearing in this catalog are the manufacturer's suggested retail prices. Actual retail prices may vary.

SOFTAIL

208 MILWAUKEE-EIGHT® SOFTAIL®

Chassis Trim – Front End

A. DEFIANCE COLLECTION – HEADLAMP TRIM RING

Ringed with deep radial grooves, Defiance Collection Headlamp Trim Rings reflect your custom taste. Available in mirror chrome, gloss black or machine cut black finishes, these cast aluminum trim rings surround the leading edge of the lamp for a solid billet look. Easy to install rings include mounting hardware.

Fits '18-later FLDE, FLHC, FLHCS, FLSB and FLSL models.

61400432	7" – Chrome.	\$159.95
61400433	7" – Black Machine Cut.	\$174.95
61400434	7" – Black Anodized.	\$159.95

Fits '18-later FXBB and FXLR models.

61400429	5-3/4" – Chrome.	\$139.95
61400430	5-3/4" – Black Machine Cut.	\$154.95
61400431	5-3/4" – Black Anodized.	\$139.95

Fits '62-later models equipped with Original Equipment or accessory Auxiliary Lamp Kits. Sold in pairs.

61400353	4" Auxiliary Lamp – Chrome.	\$199.95
61400355	4" Auxiliary Lamp – Black Machine Cut.	\$219.95
61400354	4" Auxiliary Lamp – Black Anodized.	\$199.95

B. HEADLAMP TRIM RING – GLOSS BLACK

Finish the sinister look by replacing the Original Equipment chrome headlamp trim ring with sinister black. Easy to install, the ring's rich black surface matches the stock headlamp shell finish for a unified look.

61400573	7" Headlamp.	\$39.95
-----------------	--------------	----------------

Fits '18-later FLDE, FLHC, FLHCS, FLSB and FLSL models.

61400574	5-3/4" Headlamp.	\$34.95
-----------------	------------------	----------------

Fits '18-later FXBB and FXLR models.



A. DEFIANCE HEADLAMP TRIM RING – 7" CHROME



A. DEFIANCE HEADLAMP TRIM RING – 7" BLACK MACHINE CUT



A. DEFIANCE HEADLAMP TRIM RING – 7" BLACK ANODIZED



A. DEFIANCE AUXILIARY LAMP TRIM RING – 4" BLACK MACHINE CUT



A. DEFIANCE AUXILIARY LAMP TRIM RING – 4" CHROME



B. HEADLAMP TRIM RING – 7" GLOSS BLACK

Notice: The prices appearing in this catalog are the manufacturer's suggested retail prices. Actual retail prices may vary.

MILWAUKEE-EIGHT® SOFTAIL® 209

Chassis Trim – Front End



C. 5" DEFIANCE GAUGE TRIM – BLACK MACHINE CUT



C. 5" DEFIANCE GAUGE TRIM – CHROME AND BLACK ANODIZED



C. 4" DEFIANCE GAUGE TRIM – BLACK MACHINE CUT



C. 4" DEFIANCE GAUGE TRIM – CHROME AND BLACK ANODIZED



NEW



NEW

D. CONSOLE KIT – CHROME



NEW



NEW

E. CONSOLE KIT – GLOSS BLACK

C. GAUGE BEZELS – DEFIANCE COLLECTION

The perfect finishing touch. Defiance Collection Gauge Bezels add a custom detail to the place you constantly look – your instrument cluster. Accented with deep grooves, these machined aluminum rings cover the factory gauge surround adding texture and visual interest to the dash. Available in chrome, gloss black or machine cur black finishes, these self-adhesive rings are easy to install.

Fits '18-later FLDE, FLHC, FLHCS, and FLSL models.

61400438	5" Tank Gauge – Chrome.	\$54.95
61400439	5" Tank Gauge – Black Machine Cut.	\$59.95
61400440	5" Tank Gauge – Black Anodized.	\$54.95

Fits '99-later XL (except XL1200CX, XL1200X and XL1200XS), '11-'13 FXS, '13-'17 FXSB, '13-'14 FXSBSE, '08-'13 Road Glide®, '14-'17 FXDL, and '18-later FXFB, FXFBS and FXLR models.

61400435	4" Tank Gauge – Chrome.	\$69.95
61400436	4" Tank Gauge – Black Machine Cut.	\$74.95
61400437	4" Tank Gauge – Black Anodized.	\$69.95

D. CONSOLE KIT – CHROME

Dress up your ride. Designed in the style of the Fat Boy® model's console with perforated tank strap, this mirror-chrome finished Console Kit includes the major components required to change the black or satin chrome console to a bright custom look. Easy to install, this Chrome Console Kit instantly transforms the view over the tank. Manufactured from Original Equipment components for superior fit and finish, the kit includes polished chrome instrument console, tank strap, console insert and installation hardware.

70900816	Chrome.	\$299.95
-----------------	---------	-----------------

Fits '18-later FLFB, FLFBS, and FLSB models.

70900835	Chrome.	\$299.95
-----------------	---------	-----------------

Fits '18-later FLDE, FLHC, FLHCS and FLSL models. Kit includes required wiring adapter.

E. CONSOLE KIT – GLOSS BLACK

Lead the way to the dark side. This blacked-out Console Kit includes the major components required to change the chrome or satin chrome console to a dark custom look. Easy to install, this Black Console Kit instantly transforms the view over the tank. Manufactured from Original Equipment components for superior fit and finish, the kit includes black instrument console, tank strap, console insert and installation hardware.

70900817	Gloss Black.	\$299.95
-----------------	--------------	-----------------

Fits '18-later FLFB, FLFBS, and FLSB models.

70900836	Gloss Black.	\$299.95
-----------------	--------------	-----------------

Fits '18-later FLDE, FLHC, FLHCS and FLSL models. Kit includes required wiring adapter.

SOFTAIL

Notice: The prices appearing in this catalog are the manufacturer's suggested retail prices. Actual retail prices may vary.

210 MILWAUKEE-EIGHT® SOFTAIL®

Chassis Trim – Front End

A. UPPER FORK NUT COVERS

Top it off with style. These easy to install Fork Stem Covers top off the triple tree for a cohesive look. Available in a variety of styles and finishes to complement your bike's other front end components. Sold in pairs.

Fits '06-'17 Dyna® models (except FXDB and FXDSE) and '18-later Softail® models (except FXDRS, FXFB, FXFBS, and FLSB). Also Fits '88-'13 XL (except XL1200CX, XL1200X, XL883N) '95-'05 FXD, '93-'05 FXDL, '16-later FXDLS, '94-'05 FXDS-CONV and '90-'17 FLS, FLSS, FLSTF, FLSTFB, FLSTFBS and FLSTN and '86-'17 FLSTC models.

1. 45500514	Defiance Chrome.	\$49.95
2. 45500515	Defiance Gloss Black.	\$49.95
3. 45500516	Defiance Machine Cut.	\$59.95
4. 45800113	Brass.	\$59.95
5. 45800117	Dominion™ Black.	\$74.95
6. 45800118	Dominion Bronze.	\$74.95

B. STEERING STEM BOLT COVERS

These easy to install covers hide the hex-head steering stem bolt for a custom look. Kit includes one cover and mounting hardware.

Fit '18-later Softail models (except FLFB, FLFBS, FXBB, FXDRS, FXFB and FXFBS).

1. 45700049	Defiance Chrome.	\$34.95
2. 45700050	Defiance Gloss Black.	\$34.95
3. 45700051	Defiance Machine Cut.	\$39.95
4. 45800126	Brass.	\$34.95
5. 45700042	Dominion Black.	\$64.95
6. 45700041	Dominion Bronze.	\$64.95



UPPER FORK NUT COVERS AND STEERING STEM COVERS – DEFIANCE CHROME



A. UPPER FORK NUT COVERS



B. STEERING STEM COVERS

Notice: The prices appearing in this catalog are the manufacturer's suggested retail prices. Actual retail prices may vary.

MILWAUKEE-EIGHT® SOFTAIL® 211

Tank Trim



NEW

C. CUSTOM FUEL CAPS AND TANK TRIM – DOMINION BLACK



NEW

C. CUSTOM FUEL CAPS AND TANK TRIM – DOMINION BRONZE



NEW

C. CUSTOM FUEL CAPS AND TANK TRIM – GLOSS BLACK



C. CUSTOM FUEL CAP AND TANK TRIM – BRASS COLLECTION



C. CUSTOM FUEL CAP AND TANK TRIM – DIAMOND BLACK



C. CUSTOM FUEL CAP AND TANK TRIM – SKULL



C. CUSTOM FUEL CAP AND TANK TRIM – AGITATOR



D. SELF-LOCKING FUEL CAP – CHROME



NEW

D. SELF-LOCKING FUEL CAP – GLOSS BLACK

C. CUSTOM FUEL CAPS AND TANK TRIM

Add a custom touch to your tank. Styled to reflect your attitude, these elegantly constructed fuel caps are the perfect match for your ride. The Right Side Fuel Cap is easy to install and features a ratcheting design to ensure that the design faces the correct direction. And the Left Side Decorative Fuel Tank Caps mirror the fuel cap design for a symmetrical view over the tank.

RIGHT SIDE FUEL CAPS

Fits '92-later XL, '92-'17 Dyna® (except '04-later FXD and FXDX, '05-'06 FXDC and '07 FXDSE), '00-later Softail®, (except FXSTD and FXSTSSE) '94-later Road King® and '15-later Freewheeler® models. Does not fit models equipped with Original Equipment locking or tethered fuel caps. Use on '13-'14 FXSBSE requires removal of stock flush mount trim ring.

61100107	Dominion™ Gloss Black.	\$89.95
61100106	Dominion Bronze.	\$89.95
61100093	Gloss Black.	\$34.95
61100076	Brass Collection.	\$119.95
61100126	Diamond Black.	\$49.95
61100103	Black Skull.	\$59.95
61100125	Skull.	\$59.95
61100127	Agitator.	\$99.95

LEFT SIDE DECORATIVE TANK TRIM

Fits '18-later Softail models (except FXBB, FXBR, FXBRS, FXDRS, FXFB and FXFBS).

57300186	Dominion Gloss Black.	\$89.95
57300185	Dominion Bronze.	\$89.95
57300236	Gloss Black.	\$34.95
57300165	Brass Collection.	\$119.95
57300151	Diamond Black.	\$49.95
57300149	Skull.	\$49.95
57300150	Agitator.	\$99.95

D. BAR & SHIELD LOGO SELF-LOCKING FUEL CAPS

Functional and stylish, this polished cap features a convenient self-locking mechanism that automatically engages when the cap is twisted into position. The key slot is hidden from view and protected from the elements by a swing-away cover that features the famous Bar & Shield logo. The cap features a built-in ratcheting feature that ensures you do not overtighten the cap and keeps the Bar & Shield logo centered in your line of sight. The kit includes two matching keys.

Fits '92-later XL, '92-'17 Dyna (except '04-'17 FXD and FXDX, '05-'06 FXDC and '07 FXDSE), '00-later Softail (except FXS), '94-later Road King and '15-later Freewheeler models. Does not fit models equipped with Original Equipment locking or tethered fuel caps. Use on '13-'14 FXSBSE requires removal of stock flush mount trim ring.

61100129	Chrome.	\$54.95
61100117	Gloss Black.	\$59.95

Note: See pages 702-703 for a complete listing of all Fuel Caps and Left Side Tank Trim.

SOFTAIL

Notice: The prices appearing in this catalog are the manufacturer's suggested retail prices. Actual retail prices may vary.

212 MILWAUKEE-EIGHT® SOFTAIL®

Chassis Trim – Rear End

REAR AXLE NUT COVERS

Cover your rear axle nut in the most traditional way. These Rear Axle Cover Kits complement the matching Front Axle Nut covers. Easy to install, these cover kits include necessary mounting hardware. Sold in pairs.

A. DOMINION™ COLLECTION REAR AXLE NUT COVERS

Express your bold, renegade attitude. The machined aluminum Dominion™ Collection Rear Axle Nut Covers add style to the front of the bike and are the perfect complement to other Dominion Collection accessories.

Fits '08-'17 Dyna® and '08-later Softail® models (except FXCW, FXCWC, FXSB, FXSBSE, FXST-AUS and '18-later FLFB, FLFBS, FXBR, FXBRS and FXDRS).

43000129 Gloss Black. **\$74.95**

43000128 Bronze. **\$74.95**

B. REAR AXLE NUT COVERS

Fits '08-'17 Dyna and '08-later Softail models (except FXCW, FXCWC, FXSB, FXSBSE, FXSE, FXST-Aus, and '18-later FLFB, FLFBS, FLSB, FXBR, FXBRS and FXDRS).

41705-09 Chrome – Die-cast. **\$29.95**

43132-08 Chrome – Billet. **\$42.95**

43422-09 Gloss Black – Billet. **\$42.95**

C. REAR AXLE NUT COVERS – SATIN CHROME

Cover your rear axle nut in the most traditional way. These Rear Axle Cover Kits complement the matching Front Axle Nut covers. Easy to install, these cover kits include necessary mounting hardware. Sold in pairs.

43000110 **\$29.95**

Fits '08-'17 Dyna and '08-later Softail models (except FXCW, FXCWC, FXSB, FXSBSE, FXSE, FXST-Aus, and '18-later FLFB, FLFBS, FLSB, FXBR, FXBRS and FXDRS).

D. REAR AXLE NUT COVERS – BRASS COLLECTION

Artistically manufactured from solid brass, these components feature a natural antique finish that will age and patina when exposed to the elements. Brass Collection Rear Axle Nut Covers complement the matching Front Axle Nut covers. Easy to install kits include all necessary mounting hardware. Sold in pairs.

43000050 **\$54.95**

Fits '08-'17 Dyna and '08-later Softail models (except FXCW, FXCWC, FXSB, FXSBSE, FXSE, FXST-Aus, and '18-later FLFB, FLFBS, FLSB, FXBR, FXBRS and FXDRS).

E. REAR AXLE NUT COVERS – H-D MOTOR CO. LOGO

41704-09 **\$31.95**

Fits '08-'17 Dyna and '08-later Softail models (except FXCW, FXCWC, FXSB, FXSBSE, FXSE, FXST-Aus, and '18-later FLFB, FLFBS, FLSB, FXBR, FXBRS and FXDRS).

F. REAR AXLE NUT COVERS – WILLIE G SKULL

41706-09A **\$34.95**

Fits '08-'17 Dyna and '08-later Softail models (except FXCW, FXCWC, FXSB, FXSBSE, FXSE, FXST-Aus, and '18-later FLFB, FLFBS, FLSB, FXBR, FXBRS and FXDRS).



A. DOMINION REAR AXLE NUT COVERS – GLOSS BLACK



A. DOMINION REAR AXLE NUT COVERS – BRONZE



B. REAR AXLE NUT COVERS – CHROME



B. REAR AXLE NUT COVERS – GLOSS BLACK



C. REAR AXLE NUT COVERS – SATIN CHROME



D. REAR AXLE NUT COVERS – BRASS COLLECTION



E. REAR AXLE NUT COVERS – H-D MOTOR CO. LOGO



F. REAR AXLE NUT COVERS – WILLIE G SKULL

Notice: The prices appearing in this catalog are the manufacturer's suggested retail prices. Actual retail prices may vary.

MILWAUKEE-EIGHT® SOFTAIL® 213

Chassis Trim – Rear End



G. REAR AXLE NUT COVERS – FAT BOY AND BREAKOUT – CHROME



G. REAR AXLE NUT COVERS – FAT BOY AND BREAKOUT – GLOSS BLACK



G. REAR AXLE NUT COVERS – FAT BOY AND BREAKOUT – SATIN CHROME



H. DOMINION COLLECTION REAR AXLE NUT COVERS – FXDRS, BLACK



H. DOMINION COLLECTION REAR AXLE NUT COVERS – FXDRS, BRONZE



I. REAR AXLE NUT COVERS – FXDRS, GLOSS BLACK



J. SWINGARM PIVOT BOLT COVERS – BRASS COLLECTION

G. REAR AXLE NUT COVERS – FAT BOY® AND BREAKOUT®

Cover your rear axle nut in the most traditional way. These rear axle covers fit into the recessed eye of the swingarm, and the low profile design allows installation without removal of the mufflers. Easy to install, these cover kits include necessary mounting hardware. Sold in pairs.

Fits '08-'17 Dyna® and '08-later Softail® models (except FXCW, FXCWC, FXDRS, FXSB, FXSBSE, and FXST-AUS). Kit includes full left side cover and right side beauty ring.

43000108	Chrome.	\$29.95
43000109	Gloss Black.	\$29.95
43000111	Satin Chrome.	\$29.95

H. DOMINION™ COLLECTION REAR AXLE NUT COVERS

Express your bold, renegade attitude. The machined aluminum Dominion™ Collection Rear Axle Nut Covers add style to the front of the bike and are the perfect complement to other Dominion Collection accessories.

Fits '19-later FXDRS models.

43000166	Gloss Black.	\$74.95
43000167	Bronze.	\$74.95

I. REAR AXLE NUT COVERS – GLOSS BLACK

Easy to install. Kits include all necessary mounting hardware. Sold in pairs.

43000163		\$42.95
-----------------	--	----------------

Fits '19-later FXDRS models.

J. SWINGARM PIVOT BOLT COVERS – BRASS COLLECTION

Styled to complement the complete Brass Collection, these easy to install components hide the swingarm pivot bolt in classic style. Manufactured from solid brass, these heritage-finished covers feature a natural antique finish that will age and patina when exposed to the elements. Kit includes mounting hardware.

61400346	Pair.	\$54.95
-----------------	-------	----------------

Fits '08-'17 Softail models (except FXCW, FXCWC, FXSB, FXSBSE, FXSE and FXST-Aus. and models equipped with Passenger Footboard Kits).

61400344	Left Side Only.	\$34.95
61400517	Right Side Only.	\$34.95

Fits '14-later XL models.

SOFTAIL



***WARNING:** Fender rails are decorative items only. Do not strap anything to the rails. Adding additional weight to the front fender could adversely affect vehicle handling, causing loss of control and death or serious injury.

Notice: The prices appearing in this catalog are the manufacturer's suggested retail prices. Actual retail prices may vary.



FAT BOY®

TWIN-CAM SOFTAIL® | FLSTF | VIVID BLACK

Imagine a bodybuilder in a fitted suit: beefed up but elegant, decked out from head to toe. The Vivid Black paint reflects the massive chrome wheels, the chrome front end and Freight Train Headlamp Nacelle, and the chrome-covered powertrain. Great for a night out anywhere.



Badlander® Seat..... p229



Airflow Footboard & Shifter Peg..... p598



Airflow Hand Grips (Chrome)..... p598

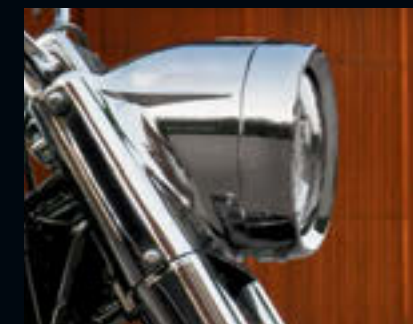

Freight Train Headlight Nacelle (Chrome)..... p266

DEFY THE WIND

At highway speed, you take the wind full-force in the chest, causing fatigue in your arms, neck and shoulders.

Take the pressure off with an easy-to-install detachable windshield.

Shaped to divert air, rain and road debris around the rider, a windshield can add hours of riding comfort.

KEEPING YOU COVERED

20.1 IN

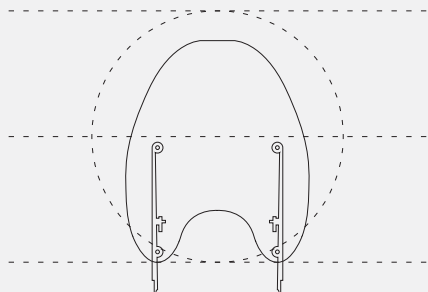

SUPER SPORT

Eliminates wind and debris, but keeps the wind-in-the-hair feeling. Ideal for a cool morning ride to the office, the sleek profile hugs the front lamps for a sporty look.

21.4 IN

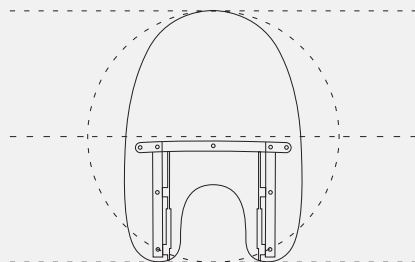

COMPACT

Traditional king-sized shape with a minimalist edge. For Harley-Davidson® custom and cruiser models, the Compact windshield provides wind and weather protection for every-day riding.

23.1 IN

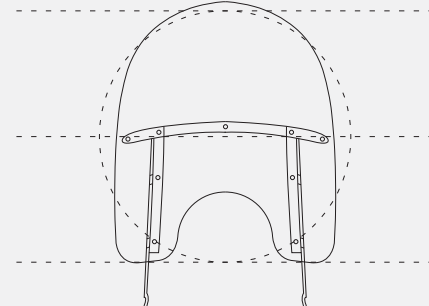

KING SIZE

Nothing gets past this one. The King Size windshield is the ultimate in on-road protection. Available in a variety of shield heights, the road can't lay a finger on you.

READY FOR TAKE-OFF

Designed to be installed or removed without tools in seconds, a detachable windshield gives you the freedom to define your ride at the drop of a hat. Ride across the country protected from the elements, then quickly remove the windshield to hit the streets in style.



To avoid looking through bug spots, condensation and road grime, select a windshield that tops out just below your line of sight.

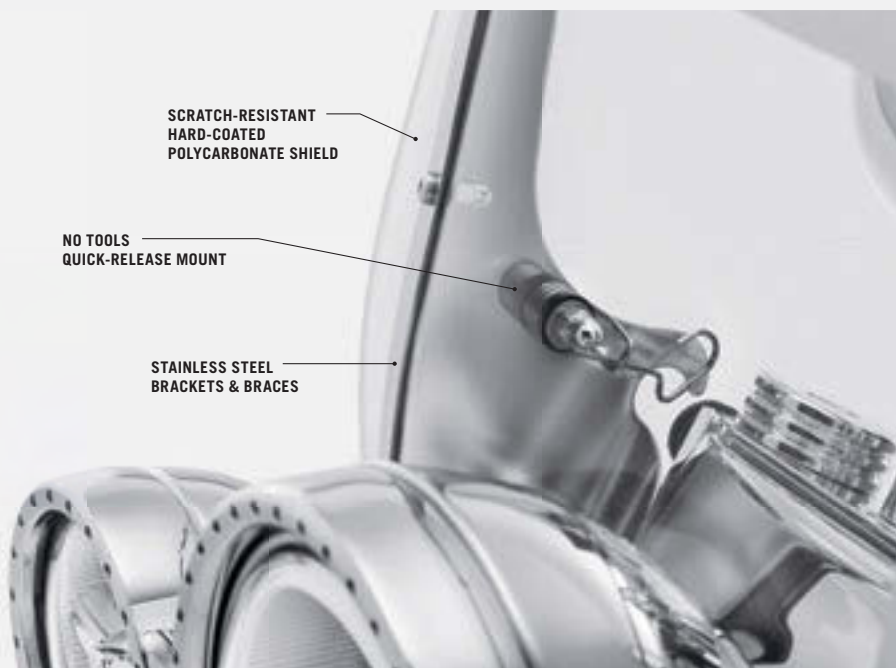

SCRATCH-RESISTANT
HARD-COATED
POLYCARBONATE SHIELD

NO TOOLS
QUICK-RELEASE MOUNT

STAINLESS STEEL
BRACKETS & BRACES

TWIN-CAM SOFTAIL® 217

Windshields – FX Softail®



A. QUICK-RELEASE SUPER SPORT WINDSHIELD (57301-06 SHOWN)

A. QUICK-RELEASE SUPER SPORT WINDSHIELD

Reduces the pounding wind and shower of bugs, but keeps the wind-in-the-hair feeling. Ideal for a cool morning ride, the sleek profile of the Super Sport Windshield hugs the front headlamp for a sporty look. The windshield mounts to the fork tubes with elegant die-cast lever-locking clamps, so the windshield does not require any "leave-behind" docking hardware. You get quick on-and-off convenience and a clean, custom look. No tools are required and the kit includes everything needed to install the windshield.

57301-06 19" Light Smoke. **\$349.95**

Fits '06-'17 FXDWG, '13-'17 FXSB and FXSBSE and '18-later FXBR and FXBRS models. Windshield dimensions: Overall height – 25.0"; width – 20.1".

57400315 23" Light Smoke. **\$399.95**

Fits '16-'17 FXSE models. Installation requires removal of Original Equipment headlamp visor. Overall height – 23.1"; width – 15.25".

57331-07 16" Light Smoke. **\$359.95**

Fits '07-'08 FXDSE and '00-'15 FXST, FXSTB and FXSTC models equipped with Custom Inverted Front Fork Kit P/N 46321-05, 46321-05A or 48646-06. Windshield dimensions: Overall height – 22.1"; width – 15.3".

B. H-D® DETACHABLES™ SUPER SPORT WINDSHIELD

Super is an apt description for this do-it-all shield. Detachable convenience. Harley-Davidson sport styling. High-quality, light smoke polycarbonate shields you from the elements. The windshield mounts to the fork tubes with H-D® Detachables™ Docking Hardware (sold separately) for easy on-and-off convenience and a quick return to a sporting profile.

57965-97A 18" Light Smoke. **\$239.95**

Fits '93-'05 FXDWG, '80-'86 FXWG and '84-'15 FXST, FXSTB and FXSTC models. Use Docking Hardware Kit P/N 58350-96. Windshield dimensions: Overall height – 22.3"; width – 17.8".

Shown with:

DOCKING HARDWARE FOR H-D DETACHABLES WINDSHIELDS

58907-96B Springer™ – Polished. **\$79.95**

Required for installation of H-D Detachables Windshields on and '93-'09 FXSTS, FXSTSB and '09 FXSTSSE, '97-'11 FLSTS, FLSTSB and FLSTSC models.

58350-96 For 41mm Forks. **\$79.95**

Required for installation of H-D Detachables Windshields on '93-'05 FXDWG, '80-'86 FXWG and '84-'15 FXST, FXSTB and FXSTC models.

58397-00 For Softail® Deuce™. **\$79.95**

Required for installation of H-D Detachables Windshields on '00-'07 FXSTD models. Does not fit FXSTDSE models.

Also available: (not shown)

WINDSHIELD DOCKING HARDWARE AND TURN SIGNAL RELOCATION KIT

Required for installation of H-D Detachables Windshields on FXDWG and FXST models equipped with Auxiliary Lighting Kits. Includes windshield mounting hardware and turn signal relocation hardware.

58361-03 **\$99.95**

Fits '93-'05 FXDWG and '84-'15 FXST, FXSTB and FXSTC models equipped with Auxiliary Lighting Kits.



A. QUICK-RELEASE SUPER SPORT WINDSHIELD (57400315 SHOWN)



B. H-D DETACHABLES SUPER SPORT WINDSHIELD

Notice: The prices appearing in this catalog are the manufacturer's suggested retail prices. Actual retail prices may vary.

SOFTAIL

218 TWIN-CAM SOFTAIL®

Windshields – FX Softail® & Springer™

A. QUICK-RELEASE COMPACT WINDSHIELD

Combine the classic Harley-Davidson® windshield shape with a revolutionary attachment system and you have the best of style and function. The windshield mounts to the fork tubes with elegant die-cast lever-release clamps, so the windshield does not require any leave-behind docking hardware. You get quick on-and-off convenience and a clean, custom look. No tools are required and the kit includes everything needed to install the windshield. The tough, hard-coated polycarbonate windshield is available in your choice of traditional polished or gloss black horizontal and vertical braces.

Fits '06-'17 FXDWG, '13-'17 FXSB and FXSBSE and '18-later FXBR and FXBRS models.

58387-06 18" Clear – Polished Braces. **\$369.95**

Windshield dimensions: Overall height – 26.8"; width – 19.5".

58444-06 14" Light Smoke – Polished Braces. **\$374.95**

Windshield dimensions: Overall height – 22.8"; width – 19.5".

Fits '93-'05 FXDWG and '86-'15 FXST, FXSTB and FXSTC models.

59802-05 19" Clear – Polished Braces. **\$429.95**

Windshield dimensions: Overall height – 23.8"; width – 21.4".

57199-05 16" Light Smoke – Polished Braces. **\$439.95**

Windshield dimensions: Overall height – 20.8"; width – 21.4".

Fits '11-'13 FXS models.

57400021 19" Clear – Black Braces. **\$429.95**

Windshield dimensions: Overall height – 23.8"; width – 21.4".

Also available:

FRONT TURN SIGNAL RELOCATION KIT

58742-05 **\$59.95**

Fits '93-'05 FXDWG, '86-'15 FXST, FXSTB and FXSTC and '00-'07 FXSTD models.

B. H-D® DETACHABLES™ COMPACT WINDSHIELD FOR MODELS WITH AUXILIARY LIGHTING

Dress up or down with the convenience of a H-D® Detachables™ Windshield. This compact-style windshield is designed to fit models equipped with Auxiliary Lighting Kit P/N 68268-03A or 69285-05.

58865-03 18" Clear. **\$299.95**

Fits '93-'05 FXDWG and '84-'15 FXST, FXSTC, FXSTB models.

Requires separate purchase of Docking Hardware Kit P/N 58361-03. Windshield dimensions: Overall height – 21.9"; width – 21.4".

C. H-D DETACHABLES COMPACT WINDSHIELD FOR SOFTAIL® SPRINGER™ MODELS

Get the convenience of detachables and the traditional Harley-Davidson look in one easy-to-install windshield. This windshield is formed from a hard-coated polycarbonate that resists scratching and abrasion. Equipped with H-D Detachables docking hardware, the windshield can be installed or removed in seconds without tools, keeping your bike ready for the open road or for a run down Main Street. Available with your choice of traditional polished or sinister gloss black vertical and horizontal braces, these windshields blend with your customizing style.

Fits '97-'03 FLSTS, '05-'07 FLSTSC and '93-'09 FXSTS, FXSTSB and '09 FXSTSSE models. Installation requires the separate purchase of Windshield Docking Hardware Kit P/N 58907-96B (chrome) or 58165-09 (black). (Will fit with or without auxiliary lighting.) Will not fit with Chrome Billet Mini Tach Mounts.

58770-96 18" Clear – Polished Braces. **\$319.95**

Windshield dimensions: Overall height – 26.8"; width – 19.9".

Fits '08-'11 FLSTSB models. Installation requires separate purchase of Windshield Docking Hardware Kit P/N 58907-96B (chrome) or 58165-09 (black).

58073-09 15" Clear – Black Braces. **\$339.95**

Windshield dimensions: Overall height – 26.8"; width – 19.7".

Shown with:

DOCKING HARDWARE FOR H-D DETACHABLES WINDSHIELDS

Required for installation of H-D Detachables Windshields on '97-'11 FLSTS, FLSTSB and FLSTSC and '93-'09 FXSTS, FXSTSB and '09 FXSTSSE models.

58907-96B Springer™ – Polished. **\$79.95**

58165-09 Springer – Black. **\$89.95**



A. QUICK-RELEASE COMPACT WINDSHIELD – POLISHED BRACES
(SHOWN WITH TURN SIGNAL RELOCATION KIT)



A. QUICK-RELEASE COMPACT WINDSHIELD – GLOSS BLACK BRACES



B. H-D DETACHABLES COMPACT WINDSHIELD FOR MODELS WITH AUXILIARY LIGHTING



C. H-D DETACHABLES COMPACT WINDSHIELD – POLISHED BRACES



C. H-D DETACHABLES COMPACT WINDSHIELD – GLOSS BLACK BRACES

Notice: The prices appearing in this catalog are the manufacturer's suggested retail prices. Actual retail prices may vary.

TWIN-CAM SOFTAIL® 219

Windshields – FL Softail®

D. KING-SIZE H-D® DETACHABLES™ WINDSHIELD FOR FL SOFTAIL® MODELS – POLISHED BRACES

Styled to complement the beefy FL Softail® front headlamp, this windshield can be installed or removed in seconds without tools, keeping your bike ready for the open road or for a run down Main Street. The windshield is formed from hard-coated polycarbonate to resist scratching and abrasion and is available with traditional polished braces and mounting brackets to blend with your customizing style. Mounting brackets are supported by molded-rubber bushings for improved isolation. Windshield kit includes all the hardware.

Fits '86-'99 FLSTC, '90-'17 FLS, FLSS, FLSTF, FLSTFB and FLSTFBS, '06 FLST and '93-'96 FLSTN models without auxiliary lamps. Does not fit Springer™ models.

58243-95 21" Clear – Polished Braces. **\$369.95**
Windshield dimensions: Overall height – 26.3"; width – 23.1".

58278-95 18" Light Smoke – Polished Braces. **\$379.95**
Windshield dimensions: Overall height – 23.4"; width – 23.1".

Fits '00-'17 FLS, FLSS, FLST, FLSTC, FLSTF, FLSTFB and FLSTFBS models equipped with auxiliary lighting. Does not fit with Custom Auxiliary Lighting Kit P/N 68000051. Includes mounting hardware.

57400114 23" Clear – Polished Braces. **\$384.95**
Windshield dimensions: Overall height – 28.3"; width – 23.1".

57400112 21" Clear – Polished Braces. **\$374.95**
Windshield dimensions: Overall height – 26.3"; width – 23.1".

57400115 18" Clear – Polished Braces. **\$359.95**
Windshield dimensions: Overall height – 23.4"; width – 23.1".

Fits '00-'17 FLS, FLSS, FLST, FLSTC, FLSTF, FLSTFB and FLSTFBS models equipped with auxiliary lighting. '00-'17 FLS, FLSS, FLST, FLSTF, FLSTFB and FLSTFBS models require separate purchase of Docking Hardware Kit P/N 91800025. Does not fit with Custom Auxiliary Lighting Kit P/N 68000051.

57061-09 18" Clear – Polished Braces. **\$334.95**
Windshield dimensions: Overall height – 23.4"; width – 23.1".

Fits '86-'99 FLSTC, '90-'99 FLSTF and FLSTFB and '93-'96 FLSTN models with auxiliary lighting. Includes mounting hardware. Does not fit Springer models.

58240-95 21" Clear – Polished Braces. **\$359.95**
Windshield dimensions: Overall height – 26.3"; width – 23.1".

58275-95 18" Light Smoke – Polished Braces. **\$369.95**
Windshield dimensions: Overall height – 23.4"; width – 23.1".

E. KING-SIZE H-D DETACHABLES WINDSHIELD FOR FL SOFTAIL MODELS – BLACK BRACES

Designed to be installed or removed without tools in seconds, a detachable windshield gives you the freedom to define your ride at the drop of a hat. Ride across the country protected from the elements, then quickly remove the windshield to hit the streets in style. This one-piece windshield is formed from hard-coated polycarbonate material to resist scratching. The shield is attached to stainless steel mounting brackets supported by molded-rubber bushings for improved isolation. Windshields are available with contemporary gloss black braces and mounting brackets and in a variety of heights to match your size and riding style.

Fits '00-'17 FLS, FLSS, FLST, FLSTC, FLSTF, FLSTFB and FLSTFBS models equipped with auxiliary lighting. Does not fit with Custom Auxiliary Lighting Kit P/N 68000051. Includes mounting hardware.

57400110 21" Clear – Black Braces. **\$394.95**
Windshield dimensions: Overall height – 26.3"; width – 23.1".

57400111 18" Light Smoke – Black Braces. **\$404.95**
Windshield dimensions: Overall height – 23.4"; width – 23.1".

Fits '86-'99 FLSTC, '90-'17 FLS, FLSS, FLSTF, FLSTFB and FLSTFBS, '06 FLST and '93-'96 FLSTN models without auxiliary lamps. Does not fit Springer models.

57688-10 21" Clear – Black Braces. **\$379.95**
Windshield dimensions: Overall height – 26.3"; width – 23.1".

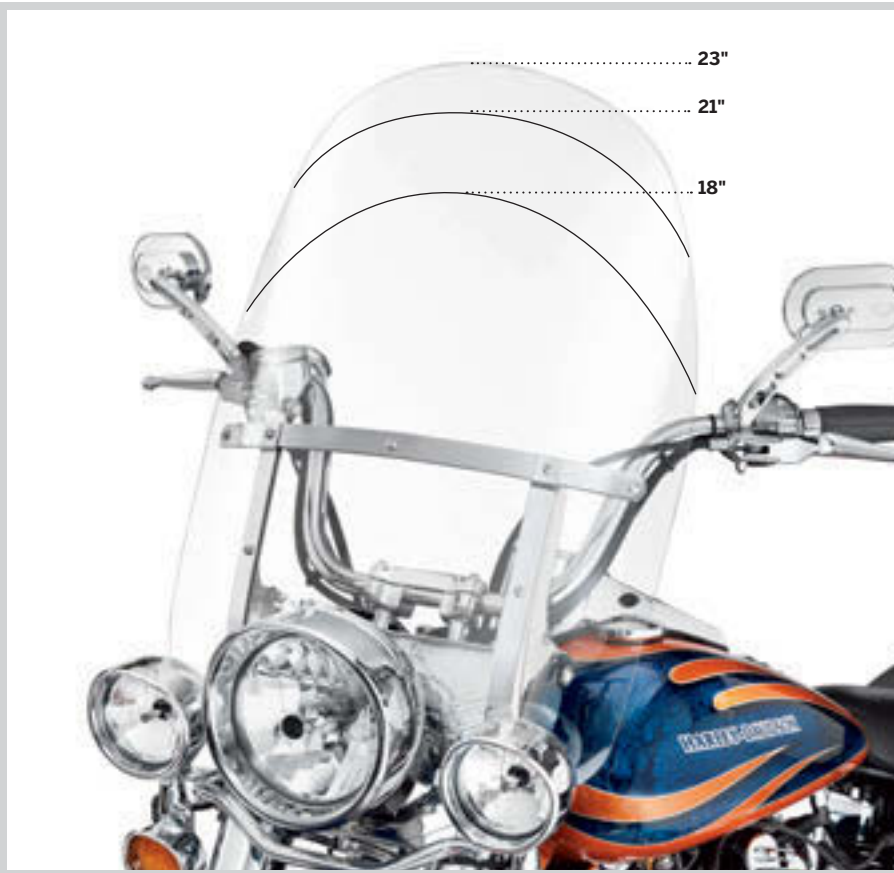

D. KING-SIZE H-D DETACHABLES WINDSHIELD FOR FL SOFTAIL MODELS – POLISHED BRACES



E. KING-SIZE H-D DETACHABLES WINDSHIELD FOR FL SOFTAIL MODELS – BLACK BRACES

SOFTAIL

Notice: The prices appearing in this catalog are the manufacturer's suggested retail prices. Actual retail prices may vary.

220 TWIN-CAM SOFTAIL®

Windshields – FL Softail®

A. KING-SIZE NOSTALGIC H-D® DETACHABLES™ WINDSHIELD FOR FL SOFTAIL® MODELS

Formed from hard-coated polycarbonate to resist scratching, this one-piece windshield features a nostalgic horseshoe-shaped outer brace with stylized Bar & Shield logo. The highly polished mounting brackets attach easily with the included mounting hardware and after initial installation, the windshield can be removed and re-attached without tools in seconds. H-D® Detachables™ Windshields are available in 21" and 18" versions to match your need for wind protection.

Fits '05-'17 FLS, FLSS and FLSTN, '86-'17 FLSTC, '00-'17 FLSTF, FLSTFB, FLSTFBS, and '06 FLST models with or without auxiliary lamps. Does not fit with Custom Auxiliary Lighting Kit P/N 68000051. Additional mounting hardware not required.

57140-05 21" Clear. **\$399.95**

Windshield dimensions: Overall height – 26.3"; width – 23.1".

57141-05 18" Light Smoke. **\$409.95**

Windshield dimensions: Overall height – 23.4"; width – 23.1".

B. KING-SIZE H-D DETACHABLES WINDSHIELD FOR NACELLE-EQUIPPED MODELS WITHOUT AUXILIARY LIGHTING

This one-piece polycarbonate windshield is designed with a larger diameter opening to wrap around the contour of the Freight Train Headlamp Nacelle Kit. Full length windshield will not fit with Original Equipment or accessory Auxiliary Lamp Kits.

Fits '86-'17 FLS, FLSS, FLSTC, FLSTF, FLSTFB and FLSTFBS, '06 FLST and '93-'96 FLSTN models equipped with the Freight Train Headlamp Nacelle Kit. Does not fit models equipped with Auxiliary Lamp Kits.

58652-97A 19" Clear. **\$379.95**

Windshield dimensions: Overall height – 26.3"; width – 23.1".

58653-97A 16" Light Smoke. **\$389.95**

Windshield dimensions: Overall height – 23.4"; width – 23.1".

Also available:

KING-SIZE H-D DETACHABLES WINDSHIELD FOR NACELLE-EQUIPPED MODELS WITH AUXILIARY LIGHTING

This one-piece polycarbonate windshield is designed with a larger diameter opening to wrap around the contour of the Freight Train Headlamp Nacelle Kit. Windshield is shaped to accept Original Equipment or accessory Auxiliary Lamp Kits.

Fits '86-'17 FLS, FLSS, FLSTC, FLSTF, FLSTFB and FLSTFBS, '06 FLST and '93-'96 FLSTN models equipped with the Freight Train Headlamp Nacelle Kit and Auxiliary Lamps.

58649-97A 19" Clear. **\$379.95**

Windshield dimensions: Overall height – 26.3"; width – 23.1".

58651-97A 16" Light Smoke. **\$389.95**

Windshield dimensions: Overall height – 23.4"; width – 23.1".



A. KING-SIZE NOSTALGIC H-D DETACHABLES WINDSHIELD FOR FL SOFTAIL MODELS



B. KING-SIZE H-D DETACHABLES WINDSHIELD FOR NACELLE-EQUIPPED MODELS WITHOUT AUXILIARY LIGHTING – 19" CLEAR

Notice: The prices appearing in this catalog are the manufacturer's suggested retail prices. Actual retail prices may vary.

TWIN-CAM SOFTAIL® 221

Windshields – FL Softail® & Springer™



C. WIND SPLITTER VENTED WINDSHIELD

C. WIND SPLITTER VENTED WINDSHIELD

Reduce helmet buffeting at speed. The Harley-Davidson® Detachables™ Wind Splitter Vented Windshield features an exclusive fingertip-adjustable center vent that reduces turbulence behind the windscreen. When open, the controlled airflow fills the negative pressure area behind the shield and helps to smooth the flow of air over the top of the screen and around the rider. The revised flow reduces helmet bobbing and neck fatigue so you can comfortably spend more time in the saddle. The open vent also provides cooling airflow to the rider at low speeds and in city traffic.

Engineered to provide the riding comfort of a larger windshield, this low-profile screen's contemporary contour sets it apart from the crowd. The shape keeps the windshield below your siteline so you don't look through bugs and road grime and the detachable design means you can ride without the shield when the mood strikes. The shield is formed of hard-coated polycarbonate for strength and scratch resistance and the dark-smoked finish reduces glare. The slim polished stainless steel brackets mount to the Original Equipment rubber isolated docking points for ease of installation and removal.

57400159 **\$429.95**

Fits '00-'17 FLSTC and FLS, FLSS, FLST, FLSTF, FLSTFB, FLSTFBS and FLSTN models equipped with auxiliary lighting. Does not fit with Custom Auxiliary Lighting Kit P/N 68000051 or with Mini Tach or Boom!™ Audio Cruiser Speakers. Windshields dimensions: Overall height – 22.4", height from headlamp opening – 16.1", width – 20.3".

D. KING-SIZE H-D® DETACHABLES™ WINDSHIELD FOR HERITAGE SPRINGER® MODELS

This one-piece windshield is formed from hard-coated polycarbonate material to resist scratching. The shield is attached to highly-polished stainless steel mounting brackets supported by molded-rubber bushings for improved isolation.

58772-97 18" Clear. **\$319.95**

Fits '97-'03 FLSTS and '05-'07 FLSTSC models. Installation requires the separate purchase of Windshield Docking Hardware Kit P/N 58907-96B. Will not fit with Chrome Billet Mini Tach Mounts. Windshield dimensions: Overall height – 27.0"; width – 23.1".



D. KING-SIZE H-D DETACHABLES WINDSHIELD FOR HERITAGE SPRINGER MODELS – 18" CLEAR

Notice: The prices appearing in this catalog are the manufacturer's suggested retail prices. Actual retail prices may vary.

222 TWIN-CAM SOFTAIL®

Windshield Accessories

A. FORK-MOUNT WIND DEFLECTORS – CHROME

Dress your bike for comfort and style. Wind Deflectors extend the windshield's coverage for superior protection in any weather. The scooped Deflectors are shaped to channel the air flow and direct the rush of air and turbulence around the rider. Deflectors attach to the fork brackets for a clean, integrated look and the chrome finish is the perfect complement to polished or chrome front end components. Easy to install kit includes all required mounting hardware.

57400143 **\$104.95**

Fits '86-'17 FLS, FLSS, FLST, FLSTC, FLSTF, FLSTFB and FLSTFBS, '93-'96 FLSTN and '10-'12 FLSTSE models equipped with Harley-Davidson® King-Size Windshield and/or Passing Lamp Kits. Does not fit Springer™ models.



A. FORK-MOUNT WIND DEFLECTORS – CHROME

B. REPLACEMENT WINDSHIELD SCREEN

Tailor your existing windshield for your riding preference. Replace the original windshield with a screen sized to improve wind protection. Uses your existing mounting brackets and hardware for an easy, economical conversion.

Fits '86-'17 FLS, FLSS, FLSTC, FLSTF, FLSTFB and FLSTFBS, '06 FLST and '93-'96 FLSTN equipped with a H-D® Detachables™ King-Size Windshield. Does not fit Springer models.

57754-04 23" Clear. **\$159.95**

57975-99 21" Light Smoke. **\$169.95**

58277-95 18" Light Smoke. **\$159.95**

Fits '86-'17 FLS, FLSS, FLSTC, FLSTF, FLSTFB and FLSTFBS, '06 FLST and '93-'96 FLSTN models equipped with the Chrome Headlamp Nacelle Kit P/N 67907-96B.

58657-97A 19" Clear. **\$144.95**



B. REPLACEMENT WINDSHIELD SCREEN

C. WINDSHIELD ACORN NUT KIT

Kit contains 10 chrome-plated low crown 12-24 acorn nuts.

94111-95 **\$9.95**

Fits Compact, King-Size, Convertible and Road King® windshields. (Pkg. of 10.)



C. WINDSHIELD ACORN NUT KIT

D. MID-FRAME AIR DEFLECTOR

Improve rider comfort during the summer riding season. Designed for severe duty and extreme temperature applications, these inconspicuous black deflectors attach to the frame and surround the top of the rear cylinder head. The scoop shape captures the moving air and uses the flow to direct the heat down and away from the rider to improve comfort. Kit includes all required mounting hardware.

29200008A **\$89.95**

Fits '08-'17 Softail® models (except FXCW, FXCWC, FXSB, FXSBSE and FXSE).



D. MID-FRAME AIR DEFLECTOR

E. LOCKING QUICK-RELEASE WINDSHIELD CLAMP

Protect your investment. This Locking Quick-Release Windshield Clamp secures your windshield from grab-and-run theft, giving you peace of mind when you have to leave your bike unattended. The chrome-plated locking clamp replaces one of the Original Equipment windshield clamps and features a push-button lock with a mini barrel-style key for easy removal. Kit includes one locking clamp and two matching keys.

57400007 41mm. **\$41.95**

Fits '93-'05 FXDWG and '88-'15 FXS, FXST, FXSTB and FXSTC models equipped with quick-release style windshields.



E. LOCKING QUICK-RELEASE WINDSHIELD CLAMP

Notice: The prices appearing in this catalog are the manufacturer's suggested retail prices. Actual retail prices may vary.

ENJOY THE RIDE

The relationship between the seat, the handlebar and the foot controls has an enormous impact on the comfort, control, and confidence you feel when riding your motorcycle. Once you've picked the bike, it's time to choose the options that match your ride to your personal dimensions.



For shorter riders, consider tailoring your fit by changing to a Reach® Seat, Mid-Foot Controls, and lowered suspension height.



For taller riders, consider altering your ride by changing to a Tallboy® Seat and Extended Foot Controls.

ESTABLISH YOUR POSITION AND FEEL

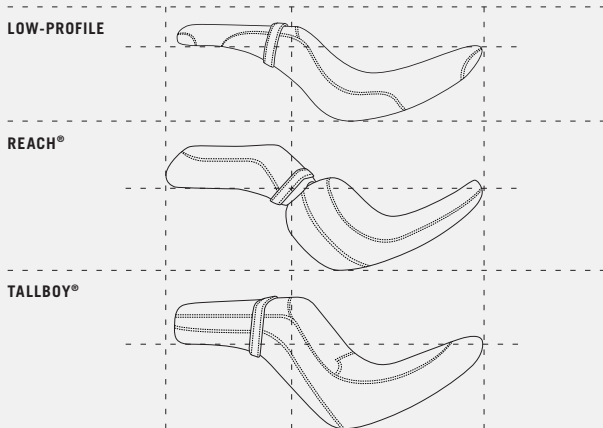

SEATS

Seat height and shape impact rider comfort, fit and confidence. Where the seat positions you relative to the foot controls, hand controls and the ground plays a major role in the quality of your ride.

SEE PAGES 224-231

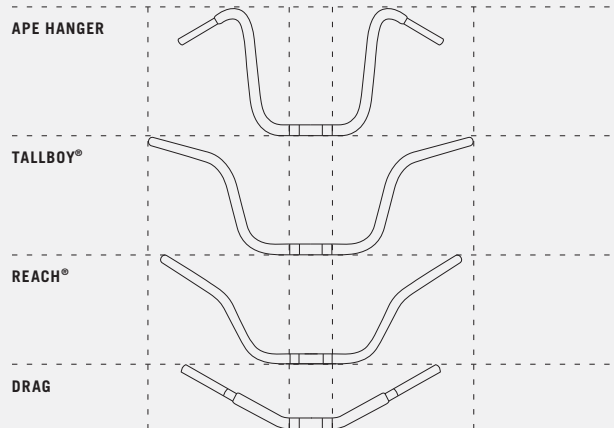

HANDLEBARS

Where the bar positions your arms, hands and wrists directly impacts how you feel on the motorcycle. Choose a bar that falls easily to hand, and does not pull you out of the seat when maneuvering.

SEE PAGES 632-641

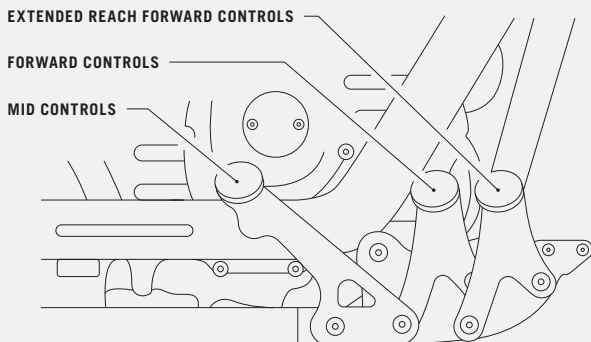

FOOT CONTROLS

Repositioning your feet can relieve muscle tension, take pressure off the tailbone and reduce fatigue. The correct riding position can add hours of comfort and hundreds of miles to your daily saddle time.

SEE PAGES 253-258, 580-613

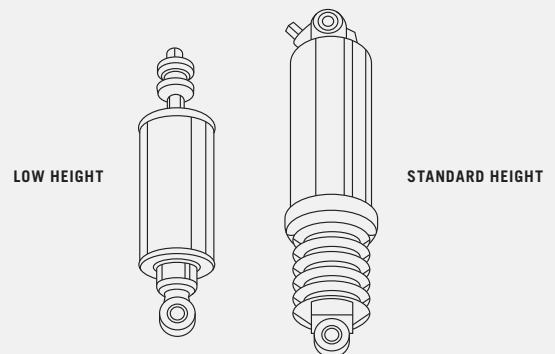

SUSPENSION

Adjusting your motorcycle's ride height by raising or lowering the suspension is often the first step in fitting the bike to your stature.

Being sure-footed at a stop can really increase your sense of confidence.

SEE PAGE 252

224 TWIN-CAM SOFTAIL®

Seating – Reach®

A. SUPER REACH® SOLO SEAT

Get a little bit closer. Super Reach® forward position seats are designed to move riders with a shorter inseam even closer to the controls and to bring the legs about 1.0" closer together so that your feet rest firmly on the pavement. The scooped bucket-shape saddle is enhanced with added back support padding to move the rider up to 1.0" lower and 2.5" forward. The combination positions the rider closer to the hand and foot controls to offer both comfort and confidence. For a two-up ride, combine the solo seat with the Touring Passenger Pillion P/N 51898-05A (sold separately).

54380-11 **\$259.95**
Fits '07-'17 FLSTC, '05-'17 FLSTN, FLSTNSE, and '05-'10 FLST and FLSTSC models. Seat width 12.0".

54381-11 **\$259.95**
Fits '07-'17 FLSTF, FLSTFB and FLSTFBS models. Seat width 12.0".

B. REACH SOLO SEAT – FXSB SOFTAIL®

Designed to position riders with a shorter inseam closer to the ground, Reach Seats are shaped to place the rider in a comfortable and confident relationship to the hand and foot controls. The wide seating surface provides loads of support while riding and the narrow tapered nose brings your legs together for an easier reach to the ground at a stop. Reach Seats feature a stepped profile that provides back support and keeps the rider from sliding back during acceleration. This Reach Solo Seat is styled to match the Softail® Breakout® model's Original Equipment seat and features a textured vinyl inlay and Harley-Davidson® medallion insert. The seating surface complements the Original Equipment passenger pillion.

52000099 **\$264.95**
Fits '13-'17 FXSB and FXSBSE, '16-'17 FXSE models. Seat width 14.5".



A. SUPER REACH SOLO SEAT (54380-11 SHOWN)



A. SUPER REACH SOLO SEAT (54381-11 SHOWN WITH ORIGINAL EQUIPMENT PASSENGER PILLION)



B. REACH SOLO SEAT – FXSB SOFTAIL

Notice: The prices appearing in this catalog are the manufacturer's suggested retail prices. Actual retail prices may vary.

TWIN-CAM SOFTAIL® 225

Seating – Reach® & Tallboy®



C. REACH SEAT

REACH® SEATS

Designed to position riders with a shorter inseam closer to the ground, Reach® Seats are shaped to place the rider in a comfortable and confident relationship to the hand and foot controls. The wide seating surface provides loads of support while riding and the narrow tapered nose brings your legs together for an easier reach to the ground at a stop. Reach Seats feature a stepped profile that provides back support and keeps the rider from sliding back during acceleration.

C. REACH SEAT

Designed specifically for riders requiring a close to the bar riding position, this seat positions the rider approximately 1.0" forward and the narrow front profile brings your legs closer together to help you plant your feet firmly on the ground. The seat features a textured vinyl insert and a Bar & Shield logo that shows you are riding in style.

52442-04A **\$374.95**

Fits '00-'17 FLST, FLSTC, FLSTNSE, FLSTSC, '00-'06 FLSTF, and '00-'05 FX Softail® models (except FXSTD). Also fits FLSTN models with removal of stock luggage rack. Seat width 13.5"; passenger pillion width 10.0".

51470-06A **\$374.95**

Fits '07-'17 FLSTF, FLSTFB, FLSTFBS, FLSTSB and '06-'15 FXST, FXSTB, FXSTC, FXSTS and '07-'08 FXSTSSE models. Does not fit FLSTSE models. FLSTSB models require separate purchase of Passenger Footpeg Mounting Kit P/N 50932-08 and passenger footpegs. Seat width 13.5"; passenger pillion width 10.0".

D. REACH SEAT – BLACKLINE™ & SOFTAIL SLIM®

The Reach forward position seat is designed to move riders 1.25" closer to the hand and foot controls. The scooped bucket-shape saddle provides a wide seating surface and added back support for long-range touring, while the narrow tapered front profile brings your legs 1.0" closer together to help your feet rest firmly on the pavement when stopped.

52000012 **\$374.95**

Fits '12-'17 FLS, FLSS and '11-'13 FXS models. Installation requires separate purchase of Passenger Footpeg Mounting Kit P/N 50932-08 and passenger footpegs. Seat width 13.5"; passenger pillion width 9.5".

E. TALLBOY® SEAT

The correct riding position can help a tall rider sit comfortably on the bike and avoid leg cramps and back strain during a long day in the saddle. For riders with a longer inseam, a Tallboy® Seat will put you on the road to fatigue-free riding. Designed to move the rider up and back from the stock seating position, a Tallboy Seat can eliminate the knees-high riding position and effectively places the body for a natural arm and leg reach to the controls. Tallboy Seats feature a bucket-shaped design for added support and a wide seating surface to reduce pressure on the tailbone. This Tallboy Seat moves the rider back 2.0" and up 3.0" as compared to the Original Equipment seat. The new position allows additional leg and arm movement for the long-limbed rider and a comfortable seating space for the open road. The Tallboy Seat features a smooth vinyl surface that complements many motorcycle models and a wide pillion for added passenger comfort.

51469-06A **\$374.95**

Fits '07-'17 FLSTF, FLSTFB, FLSTFBS, FLSTSB, and '06-'15 FXST, FXSTB, FXSTC, FXSTS and '07-'08 FXSTSSE models. Does not fit FLSTSE models. FLSTSB models require separate purchase of Passenger Footpeg Mounting Kit P/N 50932-08 and passenger footpegs. Seat width 16.5"; pillion width 12.5".



D. REACH SEAT – BLACKLINE & SOFTAIL SLIM



E. TALLBOY SEAT

Notice: The prices appearing in this catalog are the manufacturer's suggested retail prices. Actual retail prices may vary.

226 TWIN-CAM SOFTAIL®

Seating – Sundowner™

SUNDOWNER™ SEATS

The Sundowner™ Seat provides the maximum in long-riding comfort. The deep-bucket design puts your body in the proper touring position and the generous padding makes it comfortable for both the rider and passenger as the miles are adding up. The dished shape back provides added rider back support and the wide passenger pillion is shaped to minimize pressure points.

A. SUNDOWNER SEAT – SMOOTH

The smooth vinyl cover features elegant top-stitching to complement most Harley-Davidson® saddlebags and luggage.

51468-06A **\$374.95**

Fits '07-'17 FLSTF, FLSTFB, FLSTFBS, FLSTSB, and '06-'15 FXST, FXSTB, FXSTC, FXSTS and '07-'08 FXSTSSE models. Does not fit FLSTSE models. FLSTSB models require separate purchase of Passenger Footpeg Mounting Kit P/N 50932-08 and passenger footpegs. Seat width 16.5"; passenger pillion width 12.5".

51764-06 **\$359.95**

Fits '00-'17 FLST, FLSTC, FLSTNSE, FLSTSC, '00-'06 FLSTF and '00-'05 FX Softail® models (except FXSTD). Also fits FLSTN models with removal of stock luggage rack. Seat width 16.5"; passenger pillion width 12.5".



A. SUNDOWNER SEAT – SMOOTH (51468-06A SHOWN)

B. SUNDOWNER SEAT – SOFTAIL® DELUXE

Styled to complement the Softail® Deluxe model, this Sundowner Seat features a leather valance with an embossed pattern and winged logo.

51841-06 **\$394.95**

Fits '05-'17 FLSTN models. Seat width: 16.5"; passenger pillion width: 12.5".



B. SUNDOWNER SEAT – SOFTAIL DELUXE

C. SUNDOWNER SEAT – HERITAGE SOFTAIL® CLASSIC STUDS

This highly stylized seat features a leather valance with decorative chrome spots, along with intricate stitching detail on the seating surface to match the '00-'15 Heritage Softail® Classic model.

51813-09 **\$394.95**

Fits '00-'17 FLST, FLSTC, FLSTNSE, FLSTSC, '00-'06 FLSTF and '00-'05 FX Softail models (except FXSTD). Also fits FLSTN models with removal of stock luggage rack. Seat width 16.5"; passenger pillion width 12.5".



C. SUNDOWNER SEAT – HERITAGE SOFTAIL CLASSIC STUDS

Notice: The prices appearing in this catalog are the manufacturer's suggested retail prices. Actual retail prices may vary.

TWIN-CAM SOFTAIL® 227

Seating – Sundowner™



D. SUNDOWNER SEAT – BLACKLINE & SLIM

D. SUNDOWNER™ – BLACKLINE™ & SOFTAIL SLIM®

The Sundowner™ Seat provides the maximum in long-riding comfort. The deep-bucket design puts your body in the proper touring position and the generous padding makes it comfortable for both the rider and passenger as the miles are adding up. The dish shape provides added rider back support and the wide passenger pillion is shaped to minimize pressure points. The smooth vinyl cover features elegant top-stitching to complement most Harley-Davidson® saddlebags and luggage.

52000011 **\$359.95**

Fits '11-'17 FLS, FLSS and '11-'13 FXS models. Installation requires separate purchase of Passenger Footpeg Mounting Kit P/N 50932-08 and passenger footpegs. Seat width 15.5"; passenger pillion width 12.0".

E. SUNDOWNER SOLO SEAT – FXSB SOFTAIL®

The Sundowner Seat provides the maximum in long-riding touring comfort. The deep-bucket design puts your body in the proper touring position and the generous padding makes it comfortable as the miles are adding up. The dish shape provides added rider back support and the wide profile is shaped to minimize pressure points. This Sundowner Solo Seat is styled to match the Softail Breakout® model's Original Equipment seat and features a textured vinyl inlay and Harley-Davidson® medallion insert. For a two-up ride, combine the solo seat with the matching Sundowner Passenger Pillion P/N 52400066 (sold separately).

52000098 **\$259.95**

Fits '13-'17 FXSB, FXSBSE and '16-'17 FXSE models. Seat width 16.0".

Shown with:

SUNDOWNER PASSENGER PILLION – FXSB SOFTAIL

Bring a passenger along for the ride. This easy-to-install detachable Passenger Pillion is styled to complement the Sundowner Solo Seat P/N 52000098. Includes grab strap.

52400066 **\$179.95**

Fits '13-'17 FXSB, FXSBSE and FXSE models equipped with Sundowner Solo Seat P/N 52000098 (does not fit with original equipment solo seats). Pillion width 12".

F. SUNDOWNER SEAT – SOFTAIL® DEUCE™

This Sundowner Seat gives you added touring comfort without sacrificing the Deuce™ style that has heads turning. Styled to match the Softail Deuce with an embroidered H-D logo.

51112-00B **\$394.95**

Fits '00-'07 FXSTD models. Seat width 14.0"; passenger pillion width 11.0".



**E. SUNDOWNER SOLO SEAT – FXSB SOFTAIL
(SHOWN WITH SUNDOWNER PASSENGER PILLION)**



F. SUNDOWNER SEAT – SOFTAIL DEUCE

Notice: The prices appearing in this catalog are the manufacturer's suggested retail prices. Actual retail prices may vary.

228 TWIN-CAM SOFTAIL®

Seating – Signature Series®

A. SIGNATURE SERIES® SEAT WITH RIDER BACKREST

A perfect combination of foam density and shape has created our most comfortable seat for long-haul touring. Both rider and passenger will be extra comfy riding to Sturgis and back with the wide seating areas. When you reach your destination, city driving will be easier with the narrow nose that helps keep your legs together. Seat features an easily removable adjustable rider backrest that folds down for easier passenger mounting. Rider backrest has a 5-position height adjustment with 1.5" range and a wide range of forward/back angle adjustment with a quick twist of the control knob.

51985-08 Smooth. **\$549.95**
Fits '07-'17 FLSTF, FLSTFB, FLSTFBS, FLSTSB, and '06-'15 FXST, FXSTB, FXSTC, FXSTS and '07-'08 FXSTSSE models. Does not fit FLSTSE models. FLSTSB models require separate purchase of Passenger Footpeg Mounting Kit P/N 50932-08 and passenger footpegs. Seat width 16.0"; passenger pillion width 14.0".

51998-08 Smooth. **\$549.95**
Fits '00-'17 FLST, FLSTC, FLSTNSE, FLSTSC, '00-'06 FLSTF and '00-'05 Softail® models (except FXSTD). Also fits FLSTN models with removal of stock luggage rack. '00-'06 FLST, FLSTC, FLSTF, FLSTSC and '00-'05 FX Softail models require separate purchase of Seat Bracket P/N 51949-09. Seat width 16.0"; passenger pillion width 14.0".

51922-09 FLSTC Styling with Studs. **\$549.95**
Fits '00-'17 FLST, FLSTC, FLSTNSE, FLSTSC, '00-'06 FLSTF and '00-'05 Softail models (except FXSTD). Also fits FLSTN models with removal of stock luggage rack. '00-'06 FLST, FLSTC, FLSTF, FLSTSC and '00-'05 FX Softail models require separate purchase of Seat Bracket P/N 51949-09. Seat width 16.0"; passenger pillion width 14.0".

54397-11 Deluxe Styling with Valance. **\$559.95**
Fits '05-'17 FLSTN models. Seat width 16.0"; passenger pillion width 14.0".



A. SIGNATURE SERIES SEAT WITH RIDER BACKREST – SMOOTH



A. SIGNATURE SERIES SEAT WITH RIDER BACKREST – FLSTC STYLING



A. SIGNATURE SERIES SEAT WITH RIDER BACKREST – DELUXE STYLING

Notice: The prices appearing in this catalog are the manufacturer's suggested retail prices. Actual retail prices may vary.

TWIN-CAM SOFTAIL® 229

Seating – Low Profile



B. BRAWLER SOLO SEAT

B. BRAWLER® SOLO SEAT

When it's time to go it alone, go in style. These premium quality cowhide leather solo saddles feature a smooth, sleek design that hugs the frame rails for a true custom look. The Brawler® seat's design places the rider "in" the bike for a low-slung riding position, and features a "kick-up" in the rear to hold the rider in place. The seating position is generally lower than stock, but not as far back as Badlander or other low profile seats. The top-grain leather seating surface and contoured foam padding provide a firm but luxurious feel. Seat does not fit with passenger pillions.

52000267 **\$349.95**

Fits '07-'17 FLSTF, FLSTFB, FLSTFBS, FLSTSB, '06-'15 FXST, FXSTB, FXSTC, FXSTS and '07-'08 FXSTSSE models. Does not fit FLSTSE models. Seat width 12.5".

C. LEATHER BADLANDER® SEAT

The traditional Badlander® seat's low and lean style sets the stage for your minimalist custom ride. The frame-hugging rider seat and the slim tapered passenger pillion visually stretch the bike and enhance the slammed look. The seat shape stays low along its entire length and follows the lines of the bike with minimal disruption, and delivers a riding position that is lower and generally further back than the stock seat. Ideal for both short riders needing to be closer to the ground, or for tall riders that want to move back in the bike without sitting higher. This seat is wrapped in supple top-grain leather and finished with an embroidered Harley-Davidson script. Kit includes leather grab strap and mounting hardware.

52000254 **\$394.95**

Fits '07-'17 FLSTF, FLSTFB, FLSTFBS, FLSTSB, '06-'15 FXST, FXSTB, FXSTC, FXSTS and '07-'08 FXSTSSE models. Does not fit FLSTSE models. FLSTSB models require separate purchase of Passenger Footpeg Mounting Kit P/N 50932-08 and passenger footpegs. Seat width 12.0"; passenger pillion width 6.5".

D. BADLANDER SEAT

Clean smooth covers, subtle top-stitching and a frame-hugging profile add up to a statement only Harley could create. The low design delivers a reduced seat height that is ideal for riders that want the shortest possible reach to the ground, and the long and lean shape allows tall riders to move back from the hand and foot controls without sitting higher on the bike. Kit includes grab strap and all mounting hardware.

51397-06A **\$299.95**

Fits '07-'17 FLSTF, FLSTFB, FLSTFBS and FLSTSB, '06-'15 FXST, FXSTB, FXSTC, FXSTS and '07-'08 FXSTSSE models. Does not fit FLSTSE models. FLSTSB models require separate purchase of Passenger Footpeg Mounting Kit P/N 50932-08 and passenger footpegs. Seat width 12.0"; passenger pillion width 6.5".

52292-00A **\$299.95**

Fits '00-'17 FLST, FLSTC, FLSTNSE, FLSTSC, '00-'06 FLSTF and '00-'05 FX Softail® models (except FXSTD). Also fits FLSTN models with removal of stock luggage rack. Seat features embroidered Harley-Davidson script logo. Seat width 12.0"; passenger pillion width 6.5".

52292-94B **\$299.95**

Fits '84-'99 Softail models (except FLSTS). Seat features embroidered Harley-Davidson script logo. Seat width 12.0"; passenger pillion width 6.5".



C. LEATHER BADLANDER SEAT



D. BADLANDER SEAT (51397-06A SHOWN)

NOTE: Some Harley-Davidson® seats are made of leather. Fine leathers or other natural materials WILL gain "character," such as wrinkles or wear, with age. This is normal. A fine, aged patina and character wrinkles are a sign of the extremely high quality materials used to construct your seat or backrest. The appearance of scars or marks on the leather are a result of using natural leather panels and should not be thought of as an imperfection. Please use Harley-Davidson Leather Protectant P/N 93600034 to protect your investment.

Notice: The prices appearing in this catalog are the manufacturer's suggested retail prices. Actual retail prices may vary.

230 TWIN-CAM SOFTAIL®

Seating – Pillion

A. TOURING PASSENGER PILLIONS*

Styled to match the stitching and texture of the Original Equipment rider seat, these stylish pillions provide an extra comfortable ride for your passenger on those long journeys.

51898-05A Smooth Styling. **\$169.95**
Fits '05-'07 FLST, and '07-'17 FLSTC, FLSTF, FLSTFB and FLSTFBS and FLSTSC models. Pillion width 14.0".

52915-07 '07-'11 Fat Boy® Styling. **\$189.95**
Fits '05-'07 FLST, and '07-'17 FLSTC, FLSTF, FLSTFB and FLSTFBS and FLSTSC models. Pillion width 14.0".

52930-05 Softail® Deluxe Styling. **\$189.95**
Fits '05-'17 FLSTN models with Original Equipment Solo Seat. Pillion width 12.0".

51763-07 Heritage Softail® Classic Styling. **\$189.95**
Fits '05-'07 FLST, and '07-'17 FLSTC, FLSTF, FLSTFB and FLSTFBS and FLSTSC models. Pillion width 14.0".

52912-00 Heritage Softail Classic Styling. **\$189.95**
Fits '84-'06 Softail models (except '05 FLSTFI 15th Anniversary models, FLSTN, FLSTS, FLSTSC or FXSTD). Pillion width 14.0".



A. TOURING PASSENGER PILLION – SMOOTH STYLING



A. TOURING PASSENGER PILLION – FAT BOY STYLING

B. PASSENGER PILLION – SOFTAIL SLIM® STYLING*

Bring a passenger along for the ride. This easy-to-install detachable Passenger Pillion features a tuck and roll cover styled to match the Original Equipment Softail Slim® solo seat. Kit includes mounting hardware and grab strap.

52400039 **\$159.95**
Fits '12-'17 FLS and FLSS models equipped with Original Equipment solo seat. Installation requires separate purchase of Passenger Footpeg Mounting Kit P/N 50932-08 and passenger footpegs. Also fits '11-'13 FXS models equipped with Tuck & Roll Solo Seat P/N 52000031. Pillion width 6.5".

C. PASSENGER GRAB RAIL

Add comfort and confidence for your riding companion. Chrome-plated handrail provides a convenient hand grip for your passenger and a secure tie-down point for pillion-mounted touring luggage.

97031-09 **\$129.95**
Fits '06-'17 FLST, FLSTC, and FLSTSC and '06 FLSTF models.



A. TOURING PASSENGER PILLION – SOFTAIL DELUXE STYLING



A. TOURING PASSENGER PILLION – HERITAGE SOFTAIL CLASSIC STYLING



B. PASSENGER PILLION – SOFTAIL SLIM STYLING



C. PASSENGER GRAB RAIL – FLSTC SHOWN



***WARNING:** Do not install on models that are not equipped with passenger footpegs. Doing so could result in death or serious injury.

Notice: The prices appearing in this catalog are the manufacturer's suggested retail prices. Actual retail prices may vary.

TWIN-CAM SOFTAIL® 231

Seating – Spring Seats



D. BOBBER SOLO SADDLE (SHOWN WITH SPRING SADDLE INSTALLATION KIT)



E. SOLO SADDLE – BLACK DIAMOND (SHOWN WITH SPRING SADDLE INSTALLATION KIT)



E. SOLO SADDLE – BLACK LEATHER (SHOWN WITH SPRING SADDLE INSTALLATION KIT)



E. SOLO SADDLE – BROWN LEATHER (SHOWN WITH SPRING SADDLE INSTALLATION KIT)



F. STANDARD LEATHER SOLO SPRING SADDLE



G. DELUXE LEATHER SOLO SPRING SADDLE WITH NOSTALGIC SKIRT

D. BOBBER SOLO SADDLE

The thick distressed black leather cover is bonded directly to the formed metal seat pan and minimizes the foam filler and the extra height it brings. The raw-edge leather pad is joined to the pan with brass rivets, and features matching brass "Milwaukee Since 1903" trim that will develop a rich patina with use. The Bar & Shield logo is embossed into the leather surface as a finishing touch. Easy to install, the bolt-on seat and a model-specific installation kit includes everything you need to get the bobber look. No cutting, welding or fabrication is necessary.

52000277 Distressed Black Leather. **\$299.95**
Fits '04-'06 and '10-later XL, '06-'17 Dyna® and '08-'17 FLS, FLSS, FLSTC, FLSTN and FXS models. Installation requires separate purchase of model-specific Rigid or Spring Seat Mounting Hardware Kit. Seat width 10.5".

E. SOLO SADDLE

Available in elegant leather, this solo seat features a low-profile design that provides the minimalistic just enough to ride look. The smooth metal seat pan and the simple frame cover leave a clean, finished appearance. Easy to install, the bolt-on seat and model-specific Spring Seat Installation Kit include everything you need to get the bobber look. No cutting, welding or fabrication is necessary and the seat can be removed and replaced with a touring seat for a two-up night on the town.

Fits '04-'06 and '10-later XL, '06-'17 Dyna and '08-'17 FLS, FLSS, FLSTC, FLSTN and FXS models. Installation requires separate purchase of model-specific Rigid or Spring Seat Mounting Hardware Kit. Seat width 10.5".

52000276	Black Diamond.	\$299.95
52000279	Black Leather.	\$299.95
52000278	Brown Leather.	\$299.95

Also available:

SPRING SADDLE INSTALLATION KIT

The torsion-style springs are designed for the optimum balance between spring suspension and support. Required for installation of Solo Saddle Kit P/N 52000277, 52000279, 52000278, 52000275, 52000276, 52000180, 54072-10, 54373-10, 52000114 and 52000113. Kit includes springs, mounting brackets, frame cover and hardware.

54376-10B **\$279.95**
Fits '08-'17 FLSTC and FLSTN models.

5200014B **\$279.95**
Fits '11-'17 FLS, FLSS and '11-'13 FXS models.

F. STANDARD LEATHER SOLO SPRING SADDLE

First offered in 1925, this timeless solo saddle offers a deep dish bucket shape and a firm leather covering. Installation requires separate purchase of model-specific Seat Bracket and Spring Kit.

52004-25 **\$269.95**
Fits '08-'15 FLSTSB, FXST, FXSTB, FXSTC and FXSTS and '86-'94 Softail® models. Does not fit '07-'09 FXSTSSE. Requires separate purchase of model-specific Mounting Hardware Kit P/N 51902-09 or 52225-89.

G. DELUXE LEATHER SOLO SPRING SADDLE WITH NOSTALGIC SKIRT

Step back to the late 1940s. Styled to complement the look of the post-war Harley® models, this deep dished leather solo saddle features a firm but comfortable seating surface. Installation requires separate purchase of model-specific Seat Bracket and Spring Kit.

52006-47B **\$269.95**
Fits '08-'15 FLSTSB, FXST, FXSTB, FXSTC and FXSTS and '86-'94 Softail models. Does not fit '07-'09 FXSTSSE. Requires separate purchase of model-specific Mounting Hardware Kit P/N 51902-09 or 52225-89.

Also available:

SOLO SEAT BRACKET/SPRING KIT

This kit is required to install Touring Solo Saddle P/N 51481-08, Deluxe Leather Solo Saddle P/N 52006-47B or Leather Solo Saddle P/N 52004-25.

51902-09 **\$239.95**
Fits '08-'15 FLSTSB, FXST, FXSTB and FXSTC models.

52225-89 **\$239.95**
Fits '86-'94 Softail models.

Notice: The prices appearing in this catalog are the manufacturer's suggested retail prices. Actual retail prices may vary.

SOFTAIL

232 TWIN-CAM SOFTAIL®

Seating Accessories

A. ROAD ZEPPELIN® SEAT PAD

Experience ultimate comfort. Designed to ensure hours of comfort in the saddle, Road Zeppelin® Seat Pads are equipped with a unique air bladder system that allows your weight to be supported evenly across the entire seating surface. Whether you have a low profile seat or a larger more comfortable seat, you will feel the benefits. This air bladder system is designed to reduce pressure points, provide shock absorption, and reduce vibration. Unlike other mouth-inflated seat pads, the Road Zeppelin Pad features an easy-to-reach integrated hand pump and metered air release valve that permits quick and controllable adjustment. You can easily adjust the comfort and support while seated on the pad. The UV-stable and snag resistant mesh cover allows air to circulate beneath the rider's body, reducing the temperature trapped between the rider and seat. Shaped to conform to most Harley-Davidson® seats, the pads feature adjustable mounting straps and a non-skid surface to keep them in place. The hand-washable seat pad can be deflated and rolled for compact storage.

52000327 Rider. **\$169.95**

Fits rider position on all models equipped with Original Equipment or accessory seats. Also fits passenger position on Touring models with large pillion area. Pad width – 14.0".

52400162 Passenger. **\$149.95**

Fits Original Equipment and accessory passenger pillions. Pad length – 12.0"; width – 9.0".



A. ROAD ZEPPELIN SEAT PAD

B. CIRCULATOR SEAT AND BACKREST PADS

Keep comfortable on your next long ride. These breathable Circulator Pads feature 3-D construction that promotes air movement and reduces heat build-up where the rider's body touches the seat or backrest. Designed to keep the rider cool by reducing the perspiration build-up between you and the seating surface, the Circulator Pad can be installed and removed in seconds for easy cleaning. The low-profile design minimizes seat-height change compared to inflatable pads, while enhancing comfort with its shock-absorbing construction. Manufactured of UV-stable materials, these seat pads resist fading when exposed to the sun. Elastic under-seat strap and non-slip base provide secure installation and the available Circulator Passenger Pillion Pad attaches to the rider pad with hook-and-loop tabs.

51076-10 Large Seat Pad. **\$99.95**

Fits Softail, Touring and Trike models with Original Equipment and accessory seats. Will not fit Bobber or Road Zeppelin seats. Pad width – 16.0".

51078-10 Passenger Pillion Pad. **\$69.95**

Fits Original Equipment and accessory passenger pillions. Pad width – 13.0".

52300103 Wide Backrest Pad. **\$59.95**

Fits wide profile rider and passenger backrest pads up to 12.0" wide and 9.0" tall.



B. CIRCULATOR SEAT AND WIDE BACKREST PADS

C. RAIN COVERS*

Featuring a handy storage sack, this black nylon, water-resistant, Cordura® cover packs easily and shelters your seat from the storm.

51638-97 Solo Seat. **\$29.95**

Fits H-D® solo seats (except XR and FLSTS).

51639-97 Two-Up. **\$31.95**

Fits VRSC™, XG, XL, Dyna® and Softail® models with Two-Up seats. Does not fit Touring and Trike models. Does not fit with Rider Backrests.



C. RAIN COVER – SOLO SEAT



C. RAIN COVER – TWO-UP SEAT



***WARNING:** Do not use while riding; could result in death or serious injury.

Notice: The prices appearing in this catalog are the manufacturer's suggested retail prices. Actual retail prices may vary.

TWIN-CAM SOFTAIL® 233

Seating Accessories



D. TANK KNEE PAD KIT



E. TANK BRA

D. TANK KNEE PAD KIT

These self-adhesive rubber knee pads provide a touch of old school style. The rich black rubber pads feature tapered ribs and a raised Bar & Shield logo to protect the surfaces where your legs contact the tank. The compact pads measure 7.0" by 2.75", and are flexible enough to fit many tank profiles. Sold in matched pairs.

57300065 **\$39.95**

Fits fuel tanks on many Street™, Sportster®, Dyna® and Softail® models. May cover a portion of fuel tank graphics. Check placement before adhering to tank.

E. TANK BRA

This tank bra is made with nonabrasive, fleece-backed vinyl material and features an embroidered Bar & Shield logo. It protects your fuel tank from scratches from keys, belt buckles and other objects. Designed for easy installation and a custom fit without disassembly of the tank or seat.

57799-00 **\$43.95**

Fits '93-'03 FXDWG and '00-'17 Softail models (except FXCW, FXCWC, FXS, FXSB, FXSE, FXSTD, FXSTDSE, FXSTSE, FXSTSSE, '09-'17 FLS, FLSS, FLSTC, FLSTSB and FLSTSE and '06 FLSTFSE).

F. REAR FENDER BIB

Complete the stripped-down solo look by replacing the Original Equipment passenger pillion with this decorative fender cover. Form-fitted to hug the contour of the rear fender, this decorative fender cover hides the passenger pillion mounting holes that are exposed when riding with a solo seat. Styled to match the Original Equipment solo seat, the Fender Bib features a textured leather insert to complete the custom look. The molded base is finished with a soft felt underliner designed to protect the fender's painted surface.

52018-08 Softail Deluxe Styling. **\$69.95**

Fits '05-'17 FLSTN models equipped with Original Equipment rider seat.

52038-08 Fat Boy® Styling. **\$69.95**

Fits '07-'17 FLSTF, FLSTFB and FLSTFBS models equipped with Original Equipment rider seat.



F. REAR FENDER BIB – SOFTAIL DELUXE MODELS



F. REAR FENDER BIB – FAT BOY MODELS

G. QUICK-RELEASE SEAT HARDWARE KIT

This Quick-Release Hardware Kit allows the rider to remove one-piece Harley-Davidson® seats quickly and easily. The knurled knob is easy to install or remove without tools, and the nylon washer keeps the finger tightened knob in place and rattle free. A raised-logo Harley-Davidson emblem finishes the look. SAE 1/4"-20 thread.

Fits '97-later XG, XL, Dyna, Softail (except '12-'17 FLS models equipped with Original Equipment seat), Touring and Trike models equipped with SAE 1/4"-20 seat mount hardware. Does not fit seats equipped with spring-loaded rear seat bracket.

51676-97A Chrome. **\$19.95**

10500093 Gloss Black. **\$19.95**



G. QUICK-RELEASE SEAT HARDWARE KIT – CHROME



G. QUICK-RELEASE SEAT HARDWARE KIT – GLOSS BLACK

H. CHROME SCREWS FOR FLST SEAT BRACKET

94289-94T **\$9.95**

Fits '87-'99 FLSTC, FLSTF and FLSTN models.

I. BILLET SEAT MOUNTING BRACKET – CHROME

The highly stylized design of this bracket adds a stunning look to the back of most seats.

51804-02 **\$19.95**

Replaces Bolt-On Seat Brackets P/N 51798-00, 51740-10, 52467-00, 51652-97A and 51652-83B used on most Original Equipment and accessory seats and pillions.



H. CHROME SCREWS FOR FLST SEAT BRACKET



I. CHROME SCREWS FOR FLST SEAT BRACKET

Notice: The prices appearing in this catalog are the manufacturer's suggested retail prices. Actual retail prices may vary.

SOFTAIL

BUILDING A BACKREST

A sissy bar upright and passenger backrest are the starting point to build a complete touring machine. The backrest provides long-range comfort and support and adds a feeling of control and confidence for the passenger. Start by selecting model-specific Docking Hardware, then choose a finish that matches your styling direction, determine the desired sissy bar height, and finally select a backrest pad that complements your seat.

DOCKING HARDWARE

PAGE 234



SHORT & TALL UPRIGHT

PAGE 235



SIDE PLATES

PAGE 235



PASSENGER BACKREST PAD

PAGE 237



SELECT THE DOCKING HARDWARE

2000-later Softail® Docking Hardware for H-D® Detachables™ Racks, Tour Pak® Racks & Sideplates
 Docking hardware fitment is dependent on vehicle model and saddlebag configuration.

H-D Detachables Accessory

Available to fit:

Docking Hardware

Directional Relocation Kit

No Saddlebags Detachable Sideplates 53810-00C (Chrome), 53857-00B (Wrinkle Black), 54258-10A (Gloss Black), Solo Detach Rack 53649-05A (Chrome), 53612-08, 53652-05 (Black), One-Piece Detach Sissy Bar Upright P/N 53618-05 (Chrome), 52729-08 (Black), FXS One-Piece Sissy Bar P/N 52828-11, 52760-11, Solo Detach Tour-Pak® Rack 53559-04B or Two-Up Detachable Tour-Pak Rack 54051-08A, 53066-00D.	2003-2017 FXST, FXSTB, FXSTB, FXSTS, FXSTSSE, FXSTC, FLSTF, FLSTFB, FLSTFBS, FLSTSB, 2006 FLSTFSE	53932-03A	\$44.95	53959-06 54268-10	Chrome Black	\$49.95 \$49.95
	2005-2017 FLSTN, FLST	53932-03A	\$44.95	Not Required		
	2005-2007 FLSTSC	53932-03A	\$44.95	53959-06 54268-10	Chrome Black	\$49.95 \$49.95
	2011-2017 FLS, FLSS, FXS	53932-03A	\$44.95	54296-11		\$49.95
	2013-2017 FXSB, FXSBSE, 2016-later FXSE	52300239	\$49.95	Not Required		
With P&A Saddlebags Detachable Sideplates 53810-00C (Chrome), 53857-00B (Wrinkle Black), 54258-10A (Gloss Black), Solo Detach Rack 53649-05A (Chrome), 53612-08, 53652-05 (Black), One-Piece Detach Sissy Bar Upright P/N 53618-05 (Chrome), 52729-08 (Black), Solo Detach Tour-Pak Rack 53559-04B, Two-Up Detachable Tour-Pak Rack 54051-08A, 53066-00D.	2006 FLSTFSE, 2003-2017 FLSTF, FLSTFB, FLSTFBS, FLSTSB, FXST, FXSTB, FXSTC, FXSTS, 2007-2008 FXSTSSE	53930-03B	\$49.95	53959-06 54268-10	Chrome Black	\$49.95 \$49.95
	2005-2017 FLST, FLSTN	53930-03B	\$49.95	Not Required		
	2005-2007 FLSTSC	53930-03B	\$49.95	53959-06 54268-10	Chrome Black	\$49.95 \$49.95
	2013-2017 FXSB, FXSBSE, 2016-'17 FXSE	52300243	\$64.95	Not Required		
With Original Equipment Saddlebags Detachable Sideplates 53815-00A (Chrome), Adjustable Sideplates 52300001 (Chrome), Solo Detach Rack 53649-05A (Chrome), 53652-05 (Black), Solo Detach Tour Pak Rack 53559-04B or Two-Up Detachable Tour Pak Rack 54051-08A, 53066-00D with Original Equipment Saddlebags or with P&A Saddlebags P/N 90876-05.	2003-2017 FLSTC	53931-03A	\$44.95	Not Required		
	2003 FLSTS	53931-03A	\$44.95	53959-06 54268-10	Chrome Black	\$49.95 \$49.95
	2005-2007 FLSTSC	53931-03A	\$44.95	53959-06 54268-10	Chrome Black	\$49.95 \$49.95
	2006 FLST	53931-03A	\$44.95	Not Required		
Detachable Sideplates and Hard Saddlebags 90715-08XX.	2008-2017 FLSTF, FLSTFB, FLSTFBS	53930-03B & 53075-03	\$49.95 \$32.95	Included with Hard Saddlebags		
Detachable Sideplates and Hard Saddlebags 90725-08XX.	2008-2017 FLSTN	53930-03B & 53075-03	\$49.95 \$32.95	Not Required		

*See fitment for Saddlebag Kits P/N 88237-07, 88238-07 or 88306-07. Notice: The prices appearing in this catalog are the manufacturer's suggested retail prices. Actual pricing may vary.

TWIN-CAM SOFTAIL® 235

Backrests & Racks



A. H-D DETACHABLES SIDEPLATES

A. H-D® DETACHABLES™ SIDEPLATES

In the time it takes for a traffic light to change, you can transform your motorcycle from a city cruiser to a cross country hauler. Start with Harley-Davidson® Detachables™ Sideplates, and add your choice of sissy bar upright and pad to make removing the passenger backrest a simple slide and click operation. Manufactured and tested to rigorous Harley-Davidson standards, installation requires separate purchase of model-specific Docking Hardware Kit.

Fits '00-'17 FLST, FLSTF, FLSTFB, FLSTFBS, FLSTN, FLSTNSE, FLSTSB, FLSTSC, FLSTSE, FXSB, FXSBSE, FXST, FXSTB, FXSTS, FXSTSSE and '06 FLSTFSE models with or without saddlebags (except Heritage Saddlebags P/N 90876-05). Requires separate purchase of Docking Hardware Kit and may require Directional Relocation Kit. See chart for your application.

53810-00C	Chrome.	\$149.95
54258-10A	Gloss Black.	\$149.95

Fits '00-'17 FLSTC and '00-'03 FLSTS models. Also fits '05-'15 FLST and FLSTSC models with Heritage Saddlebag P/N 90876-05. Requires separate purchase of Docking Hardware Kit and may require Directional Relocation Kit. See chart for your application.

53815-00A	Chrome.	\$144.95
------------------	---------	-----------------

SISSY BAR UPRIGHTS

Sissy Bar Uprights are available in a variety of shapes and styles. Round bar uprights feature a mini medallion bar and an embossed Bar & Shield insert. Uprights are designed to accept specific 3-bolt or 2-bolt mounted backrest pads.

B. LOW SISSY BAR UPRIGHT

Shaped to complement a thicker passenger pillion, this Low Sissy Bar Upright stands between the Standard and the Short Bar Upright. The ideal match for touring style seats, this upright also offers additional height options to riders with custom style seats.

Fits '04-later XL models with H-D® Detachables™ sideplates, '06-'17 Dyna® (except FXDF, FXDFSE and '10-'17 FXDWG), '84-'05 Softail® (except FXSTD) and '06-'17 FL Softail models (except '07-'17 FLS, FLSS, FLSTF, FLSTFB, FLSTFBS, FLSTSE and FLSTSB and '06 FLSTFSE) with appropriate sideplates.

52300022	Chrome.	\$99.95
52300024	Gloss Black.	\$99.95

Fits '07-'17 FLSTF, FLSTFB, FLSTFBS, FLSTSB, FLSTSE and FXSTC, '06 FLSTFSE, '06-'17 FXST, FXSTB and FXSTS and '07-'08 FXSTSSE models with appropriate sideplates. '07-'10 FXSTC models require separate purchase of Fender Mounted Seat.

51477-06	Chrome.	\$99.95
54256-10	Gloss Black.	\$99.95

Fits '13-'17 FXSB and FXSBSE, '16-'17 FXSE and '09 FXSTSSE models with appropriate H-D Detachables sideplates. FXSTSSE models require separate purchase of Hardware Kit P/N 52300306.

52540-09A	Chrome.	\$99.95
52300401	Gloss Black.	\$99.95

C. STANDARD SISSY BAR UPRIGHT

Give your passenger additional back support with a Standard Sissy Bar Upright designed to accept a wide variety of backrest pads.

Fits '04-later XL models with H-D Detachables sideplates, '06-'17 Dyna (except FXDF, FXDFSE and '10-'17 FXDWG), '84-'05 Softail (except FXSTD) and '06-'17 FL Softail models (except '07-'17 FLS, FLSS, FLSTF, FLSTFB, FLSTFBS, FLSTSE and FLSTSB and '06 FLSTFSE) with appropriate sideplates.

52300018	Chrome.	\$99.95
52300020	Gloss Black.	\$99.95



B. LOW SISSY BAR UPRIGHT – CHROME (52300022 SHOWN)

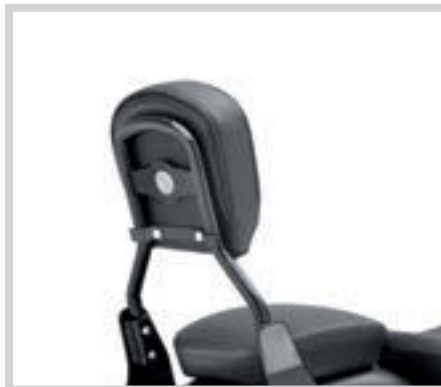

B. LOW SISSY BAR UPRIGHT – GLOSS BLACK (52300024 SHOWN)



B. LOW SISSY BAR UPRIGHT – CHROME (52540-09A SHOWN)



B. LOW SISSY BAR UPRIGHT – GLOSS BLACK (52300401 SHOWN)



C. STANDARD SISSY BAR UPRIGHT – CHROME (52300018 SHOWN)



C. STANDARD SISSY BAR UPRIGHT – GLOSS BLACK (52300020 SHOWN)

SOFTAIL

Notice: The prices appearing in this catalog are the manufacturer's suggested retail prices. Actual retail prices may vary.

236 TWIN-CAM SOFTAIL®

Backrests & Racks

A. ONE-PIECE H-D® DETACHABLES™ TALL SISSY BAR UPRIGHT – GLOSS BLACK

The sweeping shape and gloss black finish of this slim, round bar Sissy Bar Upright complements the classic bobber look of the Softail® Cross Bones® model. The one-piece design eliminates separate sideplates for a clean appearance and the stylized upper kick angle mimics the old-school sissy bars of the '50s and '60s. Can be used with Passenger Backrest Pad P/N 52631-07.

52729-08A **\$209.95**

Fits '07-'17 FLSTF, FLSTFB, FLSTFBS, FLSTSB and FLSTSE and '06-'15 FXST, FXSTB, FXSTC and FXSTS models. Requires separate purchase of Docking Hardware Kit and may require Turn Signal Relocation Kit. See Docking Hardware Fitment Chart for your application.

Shown with:

PASSENGER BACKREST PAD

Styled to complement available touring and custom seats.

52631-07 **\$74.95**

Fits One-Piece H-D® Detachables™ Sissy Bar Upright P/N 52729-08A, 51853-07, 51849-07, 51146-10A, 51161-10A 52300040A, 52300042A, 52300044A or 52300046A.

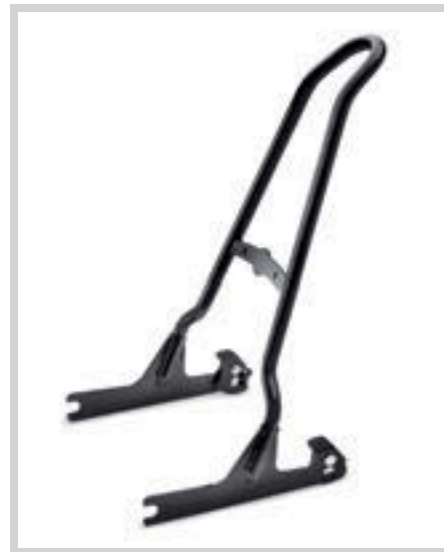

A. ONE-PIECE H-D DETACHABLES TALL SISSY BAR UPRIGHT – GLOSS BLACK (SHOWN WITH PASSENGER BACKREST PAD)

B. ONE-PIECE H-D DETACHABLES SISSY BAR UPRIGHT – CHROME

The sweeping shape of this slim, round bar Passenger Upright accents the nostalgic lines of the Softail Deluxe model and the one-piece design eliminates separate sideplates for a clean design. The chrome Detachable Upright accepts Backrest Pads P/N 53928-05, 51587-05 and 51687-06 and features a stylized Bar & Shield cross-brace.

53618-05A **\$259.95**

Fits '05-'17 FLST, FLSTN, FLSTNSE and FLSTSC. '00-'06 FLSTF and '00-'05 FXST, FXSTB and FXSTS models. Does not fit '06 FLSTSE. Fits with or without saddlebags. Does not fit with Heritage Saddlebags P/N 90876-05. Requires separate purchase of appropriate Docking Hardware Kit and may require Directional Relocation Kit.



B. ONE-PIECE H-D DETACHABLES SISSY BAR UPRIGHT – CHROME

C. ONE-PIECE H-D DETACHABLES SISSY BAR – SOFTAIL® BLACKLINE® & SOFTAIL SLIM®

Sweeping curves and a sleek gloss black finish add a custom look to this detachable Sissy Bar. Featuring a slotted base and beefy solid bar upright, the one-piece design incorporates exclusive cam lock H-D Detachables hardware that allows you to install or remove the passenger backrest in seconds. Just add your choice of backrest pad to complete the system. Available in your choice of short or standard-height designs.

Fits '11-'17 FLS and FLSS and '11-'13 FXS models. Requires separate purchase of appropriate Docking Hardware P/N 53932-03A and Turn Signal Relocation Kit P/N 54296-11. Models equipped with Side-Mount License Plate require Relocation Kit P/N 67900127A. Models equipped with a center-mount license plate and fender-mounted reflectors require installation of additional components (sold separately): Red Reflector Kit P/N 67900223 or Amber Reflector Kit P/N 67900224.

52828-11 Short, Gloss Black. **\$259.95**

52760-11 Standard-Height, Gloss Black. **\$259.95**

Also available:

PASSENGER BACKREST PAD – SOFTAIL BLACKLINE

Styled to complement the FXS Original Equipment or accessory seats, these compact Backrest Pads are the perfect match for Softail Blackline® motorcycle.

Fits '11-'17 FLS, FLSS and '11-'13 FXS models equipped with Sissy Bar P/N 52760-11 or 52828-11.

52300038 Smooth. **\$74.95**

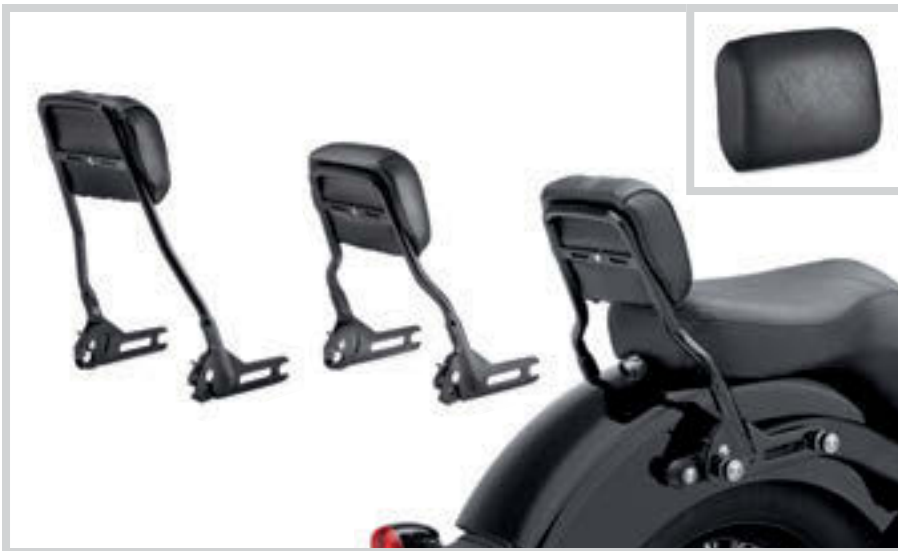

C. ONE-PIECE H-D DETACHABLES SISSY BAR – BLACKLINE & SLIM AND PASSENGER BACKREST PAD

TWIN-CAM SOFTAIL® 237

Backrests & Racks



D. BACKREST PADS

PASSENGER BACKREST PADS

Choose from a wide variety of backrest pad sizes and shapes to match your comfort and style demands. Designed to complement Original Equipment and accessory seats, these pads are engineered to fit specific sissy bar upright types.

D. BACKREST PADS

Sized to fit round bar sissy bar uprights, these pads mount to mini medallion-style uprights with two mounting holes.

Fits Standard Round Bar Mini-Medallion Style Upright P/N 52877-10 or 51168-10. Also fits Low Round Bar Mini Medallion Style Sissy Bar Upright P/N 52300401, 52540-09A, 51477-06, 54256-10, 52300049 and 52300050.

1. 51641-06	Smooth Top-Stitched.	\$74.95
2. 51640-06	Smooth Bucket.	\$99.95
3. 51622-07	Fat Boy® Lacing Bucket.	\$119.95

E. BACKREST PADS

Sized to fit medallion and mini medallion-style sissy bar uprights. Pad mounts with single center screw and bolt-on mounting strap. Kit includes chrome-plated mounting hardware.

Fits Low Medallion Style Sissy Bar Upright P/N 52655-84, 52909-02, 52754-04, 51851-09, Standard Medallion Style Sissy Bar Upright P/N 52735-85 or 52877-08, Standard Square Bar Mini Medallion Style Sissy Bar Upright P/N 53281-06 or 53407-06, Standard Heritage Style Sissy Bar Upright P/N 52731-00 and Standard Round Bar Sissy Bar Upright P/N 52300018 or 52300020.

1. 52612-95	Smooth Top-Stitched.	\$74.95
2. 52412-79A	Embossed Bar & Shield Logo.	\$79.95
3. 52348-97	Heritage Classic Bucket.	\$109.95
4. 52347-97	Fat Boy® Bucket.	\$109.95
5. 51132-98	Smooth Bucket.	\$99.95



E. BACKREST PADS

F. BACKREST PADS

Sized to fit medallion and mini medallion-style sissy bar uprights. Pad mounts with single center screw and bolt-on mounting strap. Includes chrome-plated mounting hardware.

Fits Low Medallion Style Sissy Bar Upright P/N 52754-04 or 51851-09, Low Square Bar Mini-Medallion Style Sissy Bar Upright P/N 53282-06, Standard Square Bar Mini Medallion Style Sissy Bar Upright P/N 53281-06 or 53407-06, Standard Medallion Style Sissy Bar Upright P/N 52735-85, 53007-98, 52655-84, 52909-02 or 51517-02, Standard Bar & Shield Style Sissy Bar Upright 52739-83 or 51514-02, Standard Heritage Style Sissy Bar Upright P/N 52731-00 and Low Round Bar Sissy Bar Upright P/N 52300022 or 52300024.

1. 52652-04	Smooth.	\$74.95
2. 52626-04	Smooth Top-Stitched.	\$74.95

G. TALL BACKREST PAD – SOFTAIL® DEUCE™

This taller backrest pad is designed to give the passenger more back support for the long haul. Works with the Tall Upright P/N 51144-02.

51099-02		\$79.95
Fits '00-'07 FXSTD models equipped with Deuce Tall Upright P/N 51144-02.		



F. BACKREST PADS



G. TALL BACKREST PAD – SOFTAIL DEUCE

H. SHORT BACKREST PAD FOR SOFTAIL ONE-PIECE UPRIGHT

Styled to complement the Softail® Deluxe Original Equipment seat and passenger pillion, this Short Backrest Pad hugs the contour of the one-piece upright.

53928-05	Softail Deluxe Pattern.	\$74.95
Fits One-Piece Passenger Upright P/N 53618-05.		



H. SHORT BACKREST PAD FOR SOFTAIL ONE-PIECE UPRIGHT



I. TALL BACKREST PAD FOR SOFTAIL ONE-PIECE UPRIGHT – SOFTAIL DELUXE PATTERN

I. TALL BACKREST PAD FOR SOFTAIL ONE-PIECE UPRIGHT

Styled to complement your Softail model Original Equipment seat and passenger pillion, this Tall Backrest Pad delivers additional passenger support for the run across town or across the country. Combine with a matching Touring Passenger Pillion for maximum comfort.

51587-05	Softail Deluxe Pattern.	\$99.95
Fits One-Piece Passenger Upright P/N 53618-05.		

Notice: The prices appearing in this catalog are the manufacturer's suggested retail prices. Actual retail prices may vary.

238 TWIN-CAM SOFTAIL®

Backrests & Racks

A. AIR FOIL PREMIUM LUGGAGE RACK*

The low-profile aerodynamic styling defines the look of this Luggage Rack. Available in mirror chrome or rich gloss black finish, the die-cast rear "Air Foil" grabs your attention and the Bar & Shield insert adds a signature touch. The elegant round tube rack features inlaid rubber runners for added grip and dedicated bungee mounting points to simplify luggage tie-down. Kit includes all necessary mounting hardware. For added visibility, the rack is designed to incorporate the internal wiring of the Air Foil Rack LED Light Kit P/N 68000076 (red) or 68000077 (smoked) for a clean look.

Fits '04-later XL models equipped with H-D® Detachables™ Sideplates, '06-'17 Dyna® models (except FXDF, FXDFSE and '10-'17 FXDWG) equipped with Detachable Sideplates, '84-'05 Softail® (except FLSTN and FXSTD) and '06-'17 FLST, FLSTC, FLSTNSE and FLSTSC and '06 FLSTF models equipped with Detachable Sideplates.

54290-11	Chrome.	\$214.95
54291-11	Gloss Black.	\$214.95

B. LED LIGHT KIT**

This fast-acting LED Light Kit operates as a supplemental rear running light and brake light. The high, center-mount position places the light in the line-of-sight of following vehicles and the bright, fast-acting LED lamps get you noticed. Wiring is concealed inside the rack tubes for a clean, custom installation. Available with red or smoked lens.

Fits Air Foil Luggage Rack P/N 54290-11, 54291-11 and Air Wing Sissy Bar Upright P/N 52300146 and 52300147. Installation requires separate purchase of model-specific Wiring Harness Kit.

68000076	Red Lens.	\$49.95
68000077	Smoked Lens.	\$49.95

Also available:

LED LIGHT KIT WIRING HARNESS

Required for installation of LED Light Kit on Air Foil Luggage Rack P/N 54290-11 or 54291-11.

73415-11		\$11.95
-----------------	--	----------------

Fits '06-'17 Dyna (except FXDF, FXDFSE, '14-'17 FXDL, '16-'17 FXDLS and '10-'17 FXDWG), '84-'05 Softail (except FLSTN and FXSTD), '06-'17 FLST, FLSTC and FLSTSC and '06 FLSTF models with Air Foil Luggage LED Light Kit P/N 68000076 or 68000077.

C. CUSTOM TAPERED SPORT LUGGAGE RACK*

Smooth sweeping curves and the brilliant chrome or gloss black finish define the look of this Sport Luggage Rack. Designed to complement both round and square bar Sissy Bar Uprights, this sleek rack adds a practical and stylish touch to the motorcycle.

Fits '04-later XL models (except XL1200CX) equipped with H-D Detachables Sideplates, '06-'17 Dyna models (except FXDF, FXDFSE and '10-'17 FXDWG) equipped with Detachable Sideplates, '84-'05 Softail (except FLSTN and FXSTD) and '06-'17 FLST, FLSTC, FLSTNSE and FLSTSC and '06 FLSTF models equipped with Detachable Sideplates.

50300030	Chrome.	\$149.95
50300031	Gloss Black.	\$149.95

Fits '07-'17 FLSTF, FLSTFB, FLSTFBS, FLSTSB, FLSTSE and FXSTC, '06 FLSTFSE, '06-'15 FXST, FXSTB and FXSTS and '07-'08 FXSTSSE models with Detachable Sideplates and Sissy Bar Uprights. FXSTC models require separate purchase of Fender Mounted Seat.

53953-06	Chrome.	\$149.95
54263-10	Gloss Black.	\$149.95

Fits '13-'17 FXSB and FXSBSE, '16-'17 FXSE and '09 FXSTSSE models with Detachable Sideplates and Low Sissy Bar Upright P/N 52300401 or 52540-09A.

50300066A	Chrome.	\$149.95
50300116	Gloss Black.	\$149.95



***WARNING:** Do not use this rack as a seat. Do not exceed the fender rack weight capacity. Using as seat or exceeding this capacity could cause handling problems which could result in loss of control and death or serious injury.



****WARNING:** Disconnecting your DOT required tail, brake and turn signal lighting could reduce your visibility to others and result in death or serious injury.

Notice: The prices appearing in this catalog are the manufacturer's suggested retail prices. Actual retail prices may vary.



A. AIR FOIL PREMIUM LUGGAGE RACK – CHROME



A. AIR FOIL PREMIUM LUGGAGE RACK – GLOSS BLACK

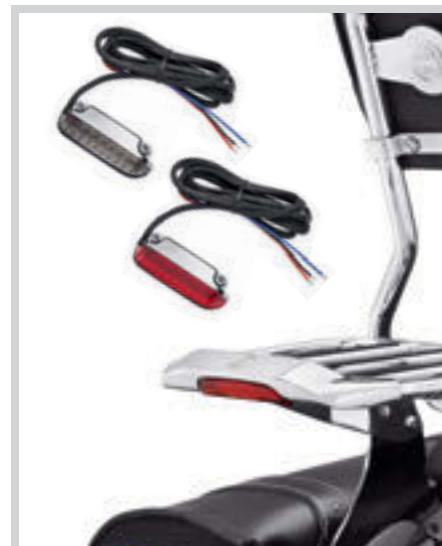

B. LED LIGHT KIT – AIR FOIL RACK



C. CUSTOM TAPERED SPORT LUGGAGE RACK – CHROME (53953-06 SHOWN)



C. CUSTOM TAPERED SPORT LUGGAGE RACK – GLOSS BLACK (54263-10 SHOWN)

TWIN-CAM SOFTAIL® 239

Backrests & Racks



D. AIR WING TWO-UP LUGGAGE RACK – CHROME

D. AIR WING TWO-UP LUGGAGE RACK*

The low-profile aerodynamic styling defines the look of this Luggage Rack. Available in mirror chrome or rich gloss black finish, the rack draws your eye with its sleek lines and the engraved Harley-Davidson script adds a signature touch. The die-cast wing and lightweight steel tubing are hand-polished before finishing for long-lasting beauty. Kit includes all necessary mounting hardware. For added visibility, the rack is designed to incorporate the internal wiring of the Air Wing Rack Light Kit P/N 68000005 or 68000006 (sold separately) for a clean look.

Fits '07-'17 FLSTF, FLSTFB, FLSTFBS, FLSTSB, FLSTSE and FXSTC, '06 FLSTFSE, '06-'15 FXST, FXSTB and FXSTS and '07-'08 FXSTSE models with H-D® Detachables™ Sideplates and Sissy Bar Uprights. FXSTC models require separate purchase of Fender Mounted Seat.

54292-11	Chrome.	\$229.95
50300009	Gloss Black.	\$229.95

E. LED LIGHT KIT**

This fast-acting LED Light Kit operates as a supplemental rear running light and brake light. The high, center-mount position places the light in the line-of-sight of following vehicles and the bright, fast-acting LED lamps get you noticed. Wiring is concealed inside the rack tubes for a clean, custom installation.

68000005 Red Lens. **\$69.95**
Fits Air Wing Luggage Rack P/N 54292-11 and 50300009.
Does not fit CVO™ models.

Also available:

LED LIGHT KIT WIRING HARNESS

Required for installation of LED Light Kit on Air Foil Luggage Rack P/N 54290-11 or 54291-11.

73415-11 **\$11.95**
Fits '06-'17 Dyna® (except FXDF, FXDFSE, '14-'17 FXDL, '16-'17 FXDLS and '10-'17 FXDWG), '84-'05 Softail® (except FLSTN and FXSTD), '06-'17 FLST, FLSTC and FLSTSC and '06 FLSTF models with Air Foil Luggage LED Light Kit P/N 68000076 or 68000077.

F. FIVE BAR SPORT LUGGAGE RACK – CHROME*

This rack brings touring flexibility to your motorcycle. Can be used with H-D Detachables or Rigid Mount Sissy Bar Sideplates.

53862-00 **\$149.95**
Fits '04-later XL models (except XL1200CX) equipped with Detachable Sideplates, '06-'17 Dyna models (except FXDF, FXDFSE and '10-'17 FXDWG) equipped with Detachable Sideplates, '84-'05 Softail (except FLSTN and FXSTD), '06-'17 FLST, FLSTC and FLSTSC and '06 FLSTF models equipped with Detachable Sideplates. Does not fit with Round Bar Uprights P/N 52300018, 52300020, 52300022 and 52300024.



D. AIR WING TWO-UP LUGGAGE RACK – GLOSS BLACK



E. LED LIGHT KIT – AIR WING RACK



F. FIVE BAR SPORT LUGGAGE RACK – CHROME



***WARNING:** Do not use this rack as a seat. Do not exceed the fender rack weight capacity. Using as seat or exceeding this capacity could cause handling problems which could result in loss of control and death or serious injury.



****WARNING:** Disconnecting your DOT required tail, brake and turn signal lighting could reduce your visibility to others and result in death or serious injury.

Notice: The prices appearing in this catalog are the manufacturer's suggested retail prices. Actual retail prices may vary.

240 TWIN-CAM SOFTAIL®

Backrests & Racks

A. H-D® DETACHABLES™ SOLO RACKS*

Add touring capabilities to your solo seat Softail® model in less than 60 seconds. This detachable Solo Rack fits over the fender when the passenger pillion is removed. The rack features brazed hand-polished tubing and the chrome or black finish adds a stylish flair. Requires Docking Hardware. Easily interchangeable with detachable Passenger Sissy Bar Upright and Sideplates.

53612-08A Gloss Black. **\$199.95**
 Fits '07-'17 FLSTF, FLSTFB, FLSTFBS, FLSTSB and FLSTSE, '06-'15 FXST, FXSTB, FXSTC and FXSTS and '07-'08 FXSTSSE models. Requires solo seat and separate purchase of Docking Hardware Kit and Turn Signal Relocation Kit. See Docking Hardware Fitment Chart for your application.

50300099A Gloss Black. **\$199.95**
 Fits '12-'17 FLS and FLSS and '11-'13 FXS models. Requires separate purchase of appropriate Docking Hardware P/N 53932-03A and Turn Signal Relocation Kit P/N 54296-11. Models equipped with Side-Mount License Plate require Relocation Kit P/N 67900127A. Models equipped with a center-mount license plate and fender-mounted reflectors require installation of additional components (sold separately): Red Reflector Kit P/N 67900223 or Amber Reflector Kit P/N 67900224.



A. H-D DETACHABLES SOLO RACK – GLOSS BLACK (53612-08A SHOWN)



A. H-D DETACHABLES SOLO RACK – GLOSS BLACK (50300099A SHOWN)

B. LOCKING H-D DETACHABLES LATCH KIT

This unique lock replaces the cam lock on your Harley-Davidson® Detachables™ accessories, providing additional security and peace of mind when parking your vehicle. The kit includes two extended-reach barrel-style keys for easy access to the lock. Key registration and replacement service is available. Sold in pairs.

Fits all models equipped with detachable Sideplates, Racks and Tour-Pak® Luggage Carriers (except '18-later Softail models with HoldFast racks and uprights or '09-later Touring models equipped with detachable Solo Tour-Pak Rack).

90300087 Chrome. **\$79.95**
90300086 Black. **\$74.95**



B. LOCKING H-D DETACHABLES LATCH KIT – CHROME



B. LOCKING H-D DETACHABLES LATCH KIT – BLACK

C. H-D DETACHABLES LATCH KIT – CHROME

Decorative chrome latches are the perfect way to enhance the appearance of your detachable accessories. Meticulously polished and chrome-plated, these easy-to-install Rotary Latches are a direct replacement for the Original Equipment satin black parts and are a simple way to add a finishing touch to your ride. Latches feature an easy-to-pull finger release to simplify access in hard-to-reach areas.

12600036 **\$49.95**
 Fits all models equipped with detachable Sideplates, One-Piece Sissy Bar Uprights, Racks, and Tour-Pak Luggage Mounting Racks (except '18-later Softail models with HoldFast™ racks and uprights).



C. H-D DETACHABLES LATCH KIT – CHROME



D. REAR DOCKING HARDWARE COVER KIT – BLACK



D. REAR DOCKING HARDWARE COVER KIT – CHROME



***WARNING:** Do not use this rack as a seat. Do not exceed the fender rack weight capacity. Using as seat or exceeding this capacity could cause handling problems which could result in loss of control and death or serious injury.

Notice: The prices appearing in this catalog are the manufacturer's suggested retail prices. Actual retail prices may vary.

TWIN-CAM SOFTAIL® 241

Saddlebags & Luggage

E. H-D® DETACHABLES™ LEATHER SADDLEBAGS – SMOOTH

These large capacity detachable saddlebags are completely removable with the simple pull of the internal handle, leaving your bike clean and ready to cruise the boulevard. The handsome leather bags feature hidden quick-release clips behind the traditional strap and buckle. When removed, the large capacity bags leave behind two simple, inconspicuous docking points. The bags are compatible with both rigid and detachable accessories when installed with the appropriate docking hardware kits. Luggage capacity: 2400 cubic inches total.

88237-07 \$859.95

Fits '03-'17 FLSTC and '03-'05 FX Softail® models (except FXSTD). Models equipped with detachable accessories (except H-D® Detachables™ Tour-Pak® Racks) require separate purchase of Docking Hardware Kit P/N 88256-07. Models equipped with H-D Detachables Tour-Pak Racks require separate purchase of Docking Hardware Kit P/N 54245-10. Models without detachable accessories require separate purchase of Docking Hardware Kit P/N 53932-03A. Models equipped with Rigid Accessories require separate purchase of Docking Hardware Kit P/N 88298-07. '03-'05 FX Softail models require separate purchase of Rear Directional Relocation Kit P/N 69857-07. Does not fit with Passenger Footboards, Rear Saddlebag Guards, Wide Tire Kits, Rear Axle Covers or Flat Lens Turn Signal Kit P/N 68431-95 or 68432-95.

88238-07 \$879.95

Fits '10 FLSTSE and '06-'17 FX Softail models (except FXCW, FXCWC, FXS, FXSB, FXSBSE, FXSE, FXSTD and FXSTSE). Models equipped with detachable accessories (except H-D Detachables Tour-Pak Racks) require separate purchase of Docking Hardware Kit P/N 88256-07. Models equipped with H-D Detachables Tour-Pak Racks require separate purchase of Docking Hardware Kit P/N 54245-10. Models without detachable accessories require separate purchase of Docking Hardware Kit P/N 53932-03A. Models equipped with Rigid Accessories also require separate purchase of Docking Hardware Kit P/N 88298-07. FXSTC models also require separate purchase of Docking Hardware Kit P/N 88297-07. All models require separate purchase of Rear Directional Relocation Kit P/N 69857-07. Does not fit with Passenger Footboards, Rear Saddlebag Guards or Rear Axle Covers.

90200616A \$859.95

Fits '07-'17 FLSTF, FLSTFB and FLSTFBS models. Models equipped with detachable accessories require separate purchase of Docking Hardware Kit P/N 88256-07. Models without detachable accessories require separate purchase of Docking Hardware Kit P/N 53932-03A. Models equipped with Rigid Accessories require separate purchase of Docking Hardware Kit P/N 88298-07. All models require separate purchase of Rear Directional Relocation Kit P/N 69929-07 or 73369-10. Does not fit with Passenger Footboards or Rear Axle Covers. FLSTFBS models require the removal of Original Equipment Rear Axle Covers.

Also available:

REAR TURN SIGNAL RELOCATION KITS

Required for installation of H-D Detachables saddlebags on specific models.

Fits '03-'17 FX Softail models (except FXCW, FXCWC, FXS, FXSB and FXSBSE).

69857-07 Chrome. **\$79.95**

69929-07 Chrome. **\$99.95**

73369-10 Black. **\$99.95**



E. H-D DETACHABLES LEATHER SADDLEBAGS – SMOOTH



STEP 1

Equipped with large capacity saddlebags, your bike is ready to take on the longest journey.



STEP 2

Pull and turn the hidden cam lock to release the bags from the docking hardware.



STEP 3

Slide the bag rearward to disengage the mounting bracket and lift the bags away.



STEP 4

You are left with a stripped-down cruiser, ready to prowl the streets.

NOTE: Some Harley-Davidson® saddlebags are made of leather. Fine leathers or other natural materials WILL gain "character," such as wrinkles or wear, with age. This is normal. A fine, aged patina and character wrinkles are a sign of the extremely high quality materials used to construct your saddlebags. The appearance of scars or marks on the leather are a result of using natural leather panels and should not be thought of as an imperfection. Please use Harley-Davidson Leather Protectant P/N 93600034 to protect your investment.

Notice: The prices appearing in this catalog are the manufacturer's suggested retail prices. Actual retail prices may vary.

242 TWIN-CAM SOFTAIL®

Saddlebags & Luggage

A. H-D® DETACHABLES™ LEATHER SADDLEBAGS – FAT BOY® LACING

Styled to complement the '07-'11 Fat Boy® model. These large capacity detachable saddlebags are completely removable with the simple pull of the internal handle, leaving your bike clean and ready to cruise the boulevard. The handsome leather bags feature hidden quick-release clips behind the traditional strap and buckle. When removed, the large capacity bags leave behind two simple, inconspicuous docking points. The bags are compatible with both rigid and H-D® Detachables™ accessories when installed with the appropriate docking hardware kits. Luggage capacity: 2400 cubic inches total.

88306-07A **\$929.95**

Fits '07-'17 FLSTF, FLSTFB and FLSTFBS models. Models equipped with detachable accessories require separate purchase of Docking Hardware Kit P/N 88256-07. Models without detachable accessories require separate purchase of Docking Hardware Kit P/N 53932-03A. Models equipped with Rigid Accessories require separate purchase of Docking Hardware Kit P/N 88298-07. All models require separate purchase of Rear Directional Relocation Kit P/N 69929-07 or 73369-10. Does not fit with Passenger Footboards or Rear Axle Covers. FLSTFBS models require the removal of Original Equipment Rear Axle Covers.



A. H-D DETACHABLES LEATHER SADDLEBAGS – FAT BOY LACING

B. H-D DETACHABLES LEATHER SADDLEBAGS – BREAKOUT®

Sized for a ride to the corner store or to Sturgis, these handsome detachable saddlebags are completely removable with the simple pull of the internal handle, leaving your bike clean and ready to cruise the boulevard. When removed, the bags leave behind two simple, inconspicuous docking points that don't cramp your sense of style. The rigid plastic tub, wrapped in genuine leather, offers long-term durability and the leather straps with magnetic tips hide quick-disconnect closures for packing convenience. The bags are compatible with both rigid and detachable accessories when installed with the appropriate docking hardware kits. Luggage capacity: 2100 cubic inches total.

Fits '13-'17 FXSB and FXSBSE and '16-'17 FXSE models. Installation requires separate purchase of appropriate Docking Hardware Kit. P/N 52300239. Models equipped with detachable accessories and saddlebags require Docking Kit P/N 52300243.

90200816 Smooth Leather. **\$839.95**

90201389 Black with Charcoal Panel – Pro Street Breakout. **\$859.95**

Shown with:

DOCKING HARDWARE KIT – BREAKOUT

Required for installation of H-D Detachables Saddlebags P/N 90200816, 90200765 or 90201389 on Breakout® models.

52300239 Saddlebags Only. **\$49.95**

Fits '13-'17 FXSB and FXSBSE and '16-'17 FXSE models.

52300243 With Detachable Accessories. **\$64.95**

Fits '13-'17 FXSB and FXSBSE and '16-'17 FXSE models equipped with Detachable Saddlebags P/N 90200765 and Detachable Accessories.



B. H-D DETACHABLES LEATHER SADDLEBAGS – BREAKOUT SMOOTH LEATHER



B. H-D DETACHABLES LEATHER SADDLEBAGS – PRO STREET BREAKOUT

NOTE: Some Harley-Davidson® saddlebags are made of leather. Fine leathers or other natural materials WILL gain "character," such as wrinkles or wear, with age. This is normal. A fine, aged patina and character wrinkles are a sign of the extremely high quality materials used to construct your saddlebags. The appearance of scars or marks on the leather are a result of using natural leather panels and should not be thought of as an imperfection. Please use Harley-Davidson Leather Protectant P/N 93600034 to protect your investment.

Notice: The prices appearing in this catalog are the manufacturer's suggested retail prices. Actual retail prices may vary.

TWIN-CAM SOFTAIL® 243

Saddlebags & Luggage



C. H-D DETACHABLES LEATHER SADDLEBAGS – SOFTAIL SLIM AND BLACKLINE (90200678 SHOWN)

C. H-D® DETACHABLES™ LEATHER SADDLEBAGS – SOFTAIL SLIM® AND BLACKLINE™ MODELS

These midsize detachable saddlebags are completely removable with the simple pull of the internal handle, leaving your bike clean and ready to cruise the boulevard. When removed, the bag leaves behind two simple, inconspicuous docking points. Styled to complement the unique look of the stripped down Softail Slim® and Blackline™ models, these bags feature a leather tub and a reinforced textured lid that complement stock and many accessory seats. The traditional leather straps conceal convenient quick-release closures for easy access and the right-hand bag also features a convenient exterior pocket with magnetic catch for easy access to your cell phone or sunglasses. The bags are compatible with H-D® Detachables™ accessories when installed with the appropriate docking hardware kits. Luggage capacity: 1900 cubic inches total.

90200678 \$879.95

Fits '11-'17 FLS and FLSS and '11-'13 FXS models. Models with Original Equipment side-mount license plate require separate purchase of License Plate Relocation Kit P/N 67900127A. Installation requires separate purchase of Turn Signal Relocation Kit P/N 67800065 and appropriate Docking Hardware Kit. Models equipped with detachable saddlebags only requires Docking Kit P/N 90200390, and models equipped with detachable accessories and saddlebags require Docking Kit P/N 90200389. Models equipped with a center-mount license plate and fender-mounted reflectors require installation of Reflector, Red P/N 67900223 or Reflector, Amber P/N 67900224. FLSS models require the removal of Original Equipment Rear Axle Covers.



D. LICENSE PLATE RELOCATION KIT (SHOWN WITH TURN SIGNAL RELOCATION KIT)



D. LICENSE PLATE RELOCATION KIT

Kit replaces Original Equipment side-mount license plate. Required for use with FLS H-D Detachables Saddlebag P/N 90200678 or 90200353B.

67900127A \$109.95

Fits '11-'17 FLS and FLSS and '11-'13 FXS models with side-mount license plate. Required for installation of detachable saddlebags or sissy bar upright.

Shown with:

TURN SIGNAL RELOCATION KIT

Kit moves turn signals from rear fender struts to a license bracket-mounted turn signal bar. Required for installation of H-D Detachables Saddlebags P/N 90200678 or 90200353B.

67800065 \$119.95

Fits '11-'17 FLS and FLSS and '11-'13 FXS models equipped with Detachable Saddlebags P/N 90200678 or 90200353B.

Also available:

DOCKING HARDWARE KIT

Required for installation of H-D Detachables Saddlebags P/N 90200353B.

90200389 Detachable Accessories. \$74.95

Fits '11-'17 FLS and FLSS and '11-'13 FXS models equipped with H-D Detachables Saddlebags and detachable accessories.

90200390 Saddlebags Only. \$49.95

Fits '11-'17 FLS and FLSS and '11-'13 FXS models equipped with H-D Detachables Saddlebags only.

E. UNIVERSAL SADDLEBAG LOCK KIT

Keep the contents of your existing soft-sided saddlebags safe from the grab-and-go thief. This unique kit features two extra-small barrel locks that can replace existing saddlebag snaps to perform double duty as locks or as snaps when you don't need to lock your bags. Can be keyed to match your barrel-style ignition key. Sold in pairs.

Fits most soft-sided leather and vinyl saddlebags. Does not fit FLHRC and FLHRS.

90300003 Keyed To Match. \$59.95

90300017 Random Key Code. \$49.95

F. SADDLEBAG TRAVEL-PAKS

Water-resistant liners make packing easy. Features inner pockets for extra storage and an embroidered Bar & Shield logo.

91959-97 \$59.95

Liner dimensions: 12.0"W x 10.0"T x 5.0"D.



E. UNIVERSAL SADDLEBAG LOCK KIT



F. SADDLEBAG TRAVEL-PAKS

SOFTAIL

Notice: The prices appearing in this catalog are the manufacturer's suggested retail prices. Actual retail prices may vary.

244 TWIN-CAM SOFTAIL®

Saddlebags & Luggage

A. LOCKING LEATHER COVERED RIGID SADDLEBAGS

These saddlebags offer a premium leather look with an extra-durable construction. The blow-molded core keeps the bag rigid and prevents sagging, while the unique lids open outward for added flair. Bags feature locks for additional security. Luggage capacity: 1800 cubic inches total.

53061-00B **\$809.95**

Fits '00-'17 Softail® models (except FLS, FLSS, FLSTNSE, FXCW, FXCWC, FXS, FXSB, FXSBSE, FXSE and FXSTD). Also fits '09 FXSTSSSE models. FXSTC models require separate purchase of Hardware Kit P/N 90573-07. Fits '84-'99 Softail models with separate purchase of Directional Relocation Kit P/N 53692-96. (FLST, FLSTC and FLSTS models do not require this Directional Relocation Kit). (Does not fit '84-'99 models equipped with H-D® Detachables™ accessories). Does not fit with Rear Axle Covers, Wide Tire Kit P/N 43684-99 or Flat Lens Turn Signal Kit P/N 68431-95. FLSTFBS models require the removal of Original Equipment Rear Axle Covers.

NOTE: Installation of these saddlebags with the following seats requires the use of Spacer Kit P/N 90976-01A: seats with rider backrests, Sundowner™ seats, stock FLSTF seat, stock FLSTC, FXSTC seat and any other seats that contact the lid of the saddlebag. Spacer Kit not required if mounting with Harley-Davidson Detachables Racks or Sideplates.

B. LOCKING RIGID SADDLEBAGS – SOFTAIL® DELUXE STYLING

Styled to complement the nostalgic look of the Softail Deluxe model, these saddlebags with pleated leather panels are anything but traditional. The rigid core allows the bag to retain its shape even after years of use. The hinged locking lid tilts outward for easy access and the embossed weave pattern, braided edging and chrome concho trim echo the Softail Deluxe seat and pillion for a coordinated look. Luggage capacity: 1900 cubic inches total.

53015-05B **\$849.95**

Fits '05-'17 FLSTN models. Does not fit FLSTNSE. Does not fit with Rear Axle Covers.

C. HERITAGE SOFTAIL® STYLE SADDLEBAGS

Original Equipment on the '06-'08 Heritage Softail Classic model, these top grade cowhide saddlebags feature reinforced rim and sides to help maintain their shape. The bags are decorated with chrome studs and a chrome-plated brass medallion coined with the Harley-Davidson logo. Saddlebag tops have rivet-reinforced corners and are secured with heavy leather straps that conceal quick-release hardware. Luggage capacity: 2200 cubic inches total.

90876-05 **\$729.95**

Fits '00-'17 FLSTC models. Also fits '00-'17 FLST models (except FLSTN, FLSTNSE, and '10-'12 FLSTSE) with the separate purchase of Saddlebag Hardware Kit P/N 79304-06.

D. SOFTAIL LEATHER SADDLEBAGS – FAT BOY® STYLING

Styled to complement the '00-'06 Fat Boy® motorcycle with the distinctive Fat Boy concho, wider is definitely better when it comes to these bags, the widest available for Softail models. Luggage capacity: 1550 cubic inches total.

90320-00D **\$749.95**

Fits '00-'17 Softail models (except FLS, FLSS, FLSTC, FLSTNSE, FXCW, FXCWC, FXS, FXSB, FXSBSE, FXSE and FXSTD). Also fits '09 FXSTSSSE models. FXSTC models require separate purchase of Hardware Kit P/N 90573-07. Also fits '84-'99 FLSTF, FXST, FXSTC and FXSTS models without H-D Detachables accessories when installed with Directional Relocation Kit P/N 53692-96. Does not fit with Rear Axle Covers, Wide Tire Kit P/N 43684-99A or Flat Lens Turn Signal Kit P/N 68431-95. FLSTFBS models require the removal of Original Equipment Rear Axle Covers.

NOTE: Some Harley-Davidson® saddlebags are made of leather. Fine leathers or other natural materials WILL gain "character," such as wrinkles or wear, with age. This is normal. A fine, aged patina and character wrinkles are a sign of the extremely high quality materials used to construct your saddlebags. The appearance of scars or marks on the leather are a result of using natural leather panels and should not be thought of as an imperfection. Please use Harley-Davidson Leather Protectant P/N 93600034 to protect your investment.

Notice: The prices appearing in this catalog are the manufacturer's suggested retail prices. Actual retail prices may vary.



A. LOCKING LEATHER COVERED RIGID SADDLEBAGS



B. LOCKING RIGID SADDLEBAGS – SOFTAIL DELUXE STYLING



C. HERITAGE SOFTAIL STYLE SADDLEBAGS



D. SOFTAIL LEATHER SADDLEBAGS – FAT BOY STYLING

TWIN-CAM SOFTAIL® 245

Saddlebags & Luggage



E. LEATHER SADDLEBAGS – FAT BOY STYLING

E. LEATHER SADDLEBAGS – FAT BOY® STYLING

Carry your essentials in style with these premium heavy leather saddlebags. They feature a reinforced tub and lid to retain their shape for the long-haul, leather straps and chrome buckles that hide quick-release clips. They are also highly stylized with a leather embossed lid that features decorative chrome spots and Spanish lacing to match the '07 Fat Boy® model. Luggage capacity: 1700 cubic inches total.

88286-07 \$679.95

Fits '00-'17 Softail® models (except FLS, FLSS, FLSTC, FLSTNSE, FXCW, FXCWC, FXS, FXSB, FXSBSE, FXSE and FXSTD). Also fits '09 FXSTSSE models. FXSTC models require separate purchase of Hardware Kit P/N 90573-07. Also fits '84-'99 FLSTF, FXST, FXSTC and FXSTS models without H-D® Detachables™ accessories when installed with Directional Relocation Kit P/N 53692-96. Does not fit with Rear Axle Covers, Wide Tire Kit P/N 43684-99A or Flat Lens Turn Signal Kit P/N 68431-95. FLSTFBS models require the removal of Original Equipment Rear Axle Covers.

F. SMOOTH LEATHER SADDLEBAGS

Shaped to accent the arching rear fender, the rounded profile and rear-swept straps set the style for this traditional saddlebag. Smooth leather flap with embossed Bar & Shield logo features leather straps and chrome buckles that conceal modern quick-release closures for one-handed access. The rigid backing plate and end panels help the bag retain its shape. Luggage capacity: 1800 cubic inches total.

90133-06B \$649.95

Fits '00-'17 Softail models (except FLS, FLSS, FLSTC, FLSTNSE, FXCW, FXCWC, FXS, FXSB, FXSBSE, FXSE and FXSTD). Also fits '09 FXSTSSE models. FXSTC models require separate purchase of Hardware Kit P/N 90573-07. Also fits '84-'99 FLSTF, FXST, FXSTC and FXSTS models without H-D Detachables accessories when installed with Directional Relocation Kit P/N 53692-96. Does not fit with Rear Axle Covers, Wide Tire Kit P/N 43684-99A or Flat Lens Turn Signal Kit P/N 68431-95. FLSTFBS models require the removal of Original Equipment Rear Axle Covers.

G. SYNTHETIC LEATHER SADDLEBAGS

These handsome bags are the perfect accessory for your Softail model. The large interior leaves plenty of room for all of your essentials and an inner pocket allows for quick access to small items such as keys, sunglasses and wallets. Luggage capacity: 1900 cubic inches total.

91537-00C \$429.95

Fits '00-'17 Softail models (except FLS, FLSS, FLSTC, FLSTNSE, FXCW, FXCWC, FXS, FXSB, FXSBSE, FXSE and FXSTD). Also fits '09 FXSTSSE models. FXSTC models require separate purchase of Hardware Kit P/N 90573-07. Also fits '84-'99 FLSTF, FXST, FXSTC and FXSTS models without H-D Detachables accessories when installed with Directional Relocation Kit P/N 53692-96. Does not fit with Rear Axle Covers, Wide Tire Kit P/N 43684-99A or Flat Lens Turn Signal Kit P/N 68431-95. FLSTFBS models require the removal of Original Equipment Rear Axle Covers.



F. SMOOTH LEATHER SADDLEBAGS



G. SYNTHETIC LEATHER SADDLEBAGS

NOTE: Some Harley-Davidson® saddlebags are made of leather. Fine leathers or other natural materials WILL gain "character," such as wrinkles or wear, with age. This is normal. A fine, aged patina and character wrinkles are a sign of the extremely high quality materials used to construct your saddlebags. The appearance of scars or marks on the leather are a result of using natural leather panels and should not be thought of as an imperfection. Please use Harley-Davidson Leather Protectant P/N 93600034 to protect your investment.

Notice: The prices appearing in this catalog are the manufacturer's suggested retail prices. Actual retail prices may vary.

246 TWIN-CAM SOFTAIL®

Saddlebags & Luggage

A. HERITAGE SOFTAIL® CLASSIC QUICK-DETACH SADDLEBAG CONVERSION KIT

Leave your baggage behind with this innovative set of quick-detach hardware. This kit converts your Original Equipment fixed-mount Heritage Softail® Classic saddlebags to bags that can be removed in just seconds. Just reach inside the bag, pull and twist the locking handle and slide the bags off. You're left with a clean, stripped-down custom look that's ready to prowl. Exclusive 3-point mounting system distributes the load to minimize flex and bounce and retains the Original Equipment weight capacity.

90200641A **\$199.95**

Fits '03-'17 FLSTC models equipped with Original Equipment Heritage Softail Classic saddlebags. Installation requires separate purchase of appropriate Docking Hardware Kit. Models equipped with detachable saddlebags alone require Docking Kit P/N 90200669. Models equipped with detachable accessories and saddlebags require Docking Kit P/N 90200670. Does not fit with Passenger Footboards, Rear Saddlebag Guards or Rear Axle Covers.

Also available:

DOCKING HARDWARE KIT

Required for installation of Quick-Detach Saddlebag Kit P/N 90200641 on FLSTC models.

90200669 Saddlebags Only. **\$49.95**

Fits '03-'17 FLSTC models equipped with Quick-Detach Saddlebag Kit P/N 90200641A only.

90200670 With Detachable Accessories. **\$59.95**

Fits '03-'17 FLSTC models equipped with Quick-Detach Saddlebag Kit P/N 90200641A and detachable accessories.

B. HERITAGE FLAT TOP & LOCK KIT

Unique saddlebag structure incorporates a barrel-style lock to secure your Heritage Softail Saddlebags and offers an unobtrusive internal reinforcement bracket that adds rigidity and preserves the original shape after extended periods of exposure to the weather. A custom-shaped plastic inner lid mounts easily to the inside of the leather lid to add additional support. Barrel-style locks are sold separately and can be ordered keyed to match your ignition switch. Kit includes reinforcement bracket, plastic inner lid and all necessary installation hardware for the left and right side bags.

88373-10A **\$139.95**

Fits '00-'15 FLSTC Original Equipment saddlebags and Heritage Style Saddlebag Kit P/N 90876-05. Requires separate purchase of Keyed-to-Match Barrel Lock Kit P/N 90300010. See instruction sheet for additional installation supplies required.

Also available:

LOCKSET – KEYED TO MATCH

Barrel style lock kit includes 2 locks and 2 keys.

90300010 **\$44.95**

For use with Heritage Flat Top & Lock Kit P/N 88373-10A.



A. HERITAGE CLASSIC QUICK-DETACH SADDLEBAG CONVERSION KIT



A. HERITAGE CLASSIC QUICK-DETACH SADDLEBAG CONVERSION KIT



B. HERITAGE FLAT TOP & LOCK KIT



B. HERITAGE FLAT TOP & LOCK KIT

Notice: The prices appearing in this catalog are the manufacturer's suggested retail prices. Actual retail prices may vary.



C. SINGLE SIDED SWINGARM BAG – ANTIQUE BROWN LEATHER



D. SINGLE SIDED SWINGARM BAG – BLACK LEATHER



E. BLACK STANDARD LINE SWINGARM BAG



F. SINGLE-SIDED SWINGARM BAG – BLACK SMOOTH LEATHER

TWIN-CAM SOFTAIL® 247

Saddlebags & Luggage

SINGLE-SIDED SWINGARM BAG

Less is more. With enough room for the essentials, these stylish Swingarm Bags eliminate the need to stuff your pockets or bungee a bag across the passenger pillion. Shaped to hug the contour of your bike's frame, these compact bags add an old-school look. Bags are constructed of heavyweight leather and feature a pouch-style flap lid that is secured with two traditional straps and buckles. The semi rigid-backed bag is secured to the left side of the bike with easy-to-install adjustable straps. Luggage capacity: 450 cubic inches total.

C. SINGLE SIDED SWINGARM BAG – ANTIQUE BROWN LEATHER

Crafted from supple brown pull-up leather, this classic Swingarm Bag will gain character and a well-worn authentic look with use. The flip-open lid is secured with traditional straps and buckles, and the bag features antique hardware that complements the old-school look.

90201568

\$219.95

Fits '00-later Softail® models (except FLSTC, FLSTNSE, FLSTSE, FXDRS, FXCW, and FXCWC). Does not fit models equipped with left hand tool box, passenger footboards, chrome swingarm covers, saddlebags, or saddlebag guards.

D. SINGLE SIDED SWINGARM BAG – BLACK LEATHER

Constructed with heavy boot-grade leather, this rich black Swingarm Bag is the perfect complement to any paint color or customizing style. The flip-open lid is secured with quick-disconnect clips hidden behind the traditional leather straps and brushed nickel-finished buckles.

90201567

\$219.95

Fits '00-later Softail models (except FLSTC, FLSTNSE, FLSTSE, FXDRS, FXCW, and FXCWC). Does not fit models equipped with left hand tool box, passenger footboards, chrome swingarm covers, saddlebags, or saddlebag guards.

E. BLACK STANDARD LINE SWINGARM BAG

Made of ultra-durable leather-like synthetic featuring a debossed H-D #1 logo, the Black Standard Collection Bags have a simple, black on black style that complements many styling directions and budgets. An internal reinforcement system maintains the bag's shape over time. The "MOLLE-style" system of mounting loops accommodate hook and loop straps and allow for multiple mounting locations and orientations. The bags feature either matte black enamel buckles with hidden quick-detach snaps or, a hook and loop flap closure. This Swingarm Bag features matte black buckles with hidden, quick-release buckles underneath. Straight and perpendicular mounting loops provide versatile and easy mounting. This bag is great for storing a small set of tools or additional layers or riding gear. Bag dimensions: 11" W x 11" H x 3.25" D. Internal capacity: 250CI. Weight/Carrying Capacity: 5 lbs.

90201768

\$129.95

Fits '00-'17 Softail models (except FLSTC, FLSTNSE, FLSTSE, FXCW, and FXCWC models). Does not fit models equipped with rear axle covers, left hand tool box, passenger footboards, chrome swingarm covers or saddlebag guards. FLSS and FLSTFBS models require removal of Original Equipment Rear Axle Covers.

F. SINGLE-SIDED SWINGARM BAG

The easy-access bag features a pouch-style flap lid that is secured with two quick-disconnect clips that are hidden behind traditional straps and buckles. The semirigid-backed bag is secured to the left side of the swingarm with easy to install adjustable quick-release straps. Bag is available in rich black leather. Luggage capacity: 400 cubic inches.

90201567

Black Smooth Leather.

\$219.95

Fits '00-'17 Softail models (except FLSTC, FLSTNSE, FLSTSE, FXCW and FXCWC models). Does not fit models equipped with rear axle covers, left hand tool box, passenger footboards, chrome swingarm covers or saddlebag guards. FLSS and FLSTFBS models require the removal of Original Equipment Rear Axle Covers.

NOTE: Some Harley-Davidson® saddlebags are made of leather. Fine leathers or other natural materials WILL gain "character," such as wrinkles or wear, with age. This is normal. A fine, aged patina and character wrinkles are a sign of the extremely high quality materials used to construct your saddlebags. The appearance of scars or marks on the leather are a result of using natural leather panels and should not be thought of as an imperfection. Please use Harley-Davidson Leather Protectant P/N 93600034 to protect your investment.

Notice: The prices appearing in this catalog are the manufacturer's suggested retail prices. Actual retail prices may vary.

248 TWIN-CAM SOFTAIL®

Saddlebags & Luggage

A. BLACK STANDARD LINE THROW-OVER SADDLEBAGS

Made of ultra-durable leather-like synthetic featuring a debossed H-D #1 logo, the Black Standard Collection Bags have a simple, black on black style that complements many styling directions and budgets. An internal reinforcement system maintains the bag's shape over time. The "MOLLE-style" system of mounting loops accommodate hook and loop straps and allow for multiple mounting locations and orientations. The bags feature matte black enamel buckles with hidden quick-detach buckles underneath. These Throw-Over bags feature side gussets for increased capacity and straight and perpendicular mounting loops for easy mounting. Quick-release buckles get you in and out of the bag fast. These Throw-Over Bags can be used with or without a passenger pillion. If used with a passenger pillion, the straps should be mounted under the pillion and the crossover straps feature a soft, non-scratch backing. Installation requires purchase of saddlebag support rails and may require the purchase of a turn signal relocation kit. Large bag measures: 16.5" L x 11.5" H x 7" D. Internal capacity: 1,350Cl. Weight capacity: 10 lbs/bag. Compact bag measures: 10" L x 11.5" H x 5.25" D. Internal capacity: 600Cl. Weight capacity: 6 lbs/bag.

Fits '82-later XL (except 1200T), '08-'17 Dyna® (except FLD), '84-'99 Softail®, and '18-later Softail models equipped with H-D® Saddlebag Supports. '18-later Softail models require purchase of Turn Signal Relocation kit P/N 67800802 or 68700830.

90201770	Large.	\$269.95
90201769	Compact.	\$219.95

B. LEATHER THROW-OVER SADDLEBAGS

These traditional Leather Throw-Over bags feature large side gussets for increased capacity and full-length straps with hidden quick-disconnect clips for easy access.

91008-82C	\$369.95
------------------	-----------------

Fits '82-later XL (except XL1200T), '08-'17 Dyna (except FLD) and '84-'99 and '18-later Softail models equipped with H-D Chrome Saddlebag Supports.

C. SADDLEBAG SUPPORTS – CHROME

Fit with or without Sissy Bar Uprights, attach easily and protect bags from contacting brake and swingarm.

91790-84C	\$114.95
------------------	-----------------

Fits '84-'06 FL Softail models (except FLSTS) and '84-'05 FX Softail models (except FXSTD). Will not fit with H-D Detachables accessories.

NEW



A. BLACK STANDARD LINE THROW-OVER SADDLEBAGS – LARGE

NEW



A. BLACK STANDARD LINE THROW-OVER SADDLEBAGS – COMPACT



B. LEATHER THROW-OVER SADDLEBAGS



C. SADDLEBAG SUPPORTS – CHROME

NOTE: Some Harley-Davidson® saddlebags are made of leather. Fine leathers or other natural materials WILL gain "character," such as wrinkles or wear, with age. This is normal. A fine, aged patina and character wrinkles are a sign of the extremely high quality materials used to construct your saddlebags. The appearance of scars or marks on the leather are a result of using natural leather panels and should not be thought of as an imperfection. Please use Harley-Davidson Leather Protectant P/N 93600034 to protect your investment.

Notice: The prices appearing in this catalog are the manufacturer's suggested retail prices. Actual retail prices may vary.

TWIN-CAM SOFTAIL® 249

Saddlebags & Luggage



D. TOUR-PAK LUGGAGE – LEATHER HERITAGE SOFTAIL STYLE



D. TOUR-PAK LUGGAGE – SMOOTH VINYL

D. TOUR-PAK® LUGGAGE

Add cross-country luggage capacity to your ride with accessory Tour-Pak® Luggage. A cavernous interior will hold one full face helmet or two half helmets. Kit includes backrest pad, interior rubber mat, hardware and instructions. Luggage Capacity: 2500 cubic inches. Dimensions: 18.5" W x 17.0" D x 13.0" H. Racks and docking kits sold separately. International models may require separate purchase of License Plate Relocation Kit P/N 60095-00A.

Fits '04-later XL (except XL883N, XL1200C, XL1200N and XL1200T) equipped with Solo Tour-Pak Rack, '00-'17 Softail® (except FLS, FLSS, FLSTNSE, FLSTSE, FXCW, FXCWC, FXS, FXSB, FXSBSE, FXSE, FXSTD and '09 FXSTSSE) equipped with H-D® Detachables™ Solo or Two-Up Tour-Pak Rack and '97-'13 Touring models equipped with H-D Detachables Two-Up or Solo Tour-Pak Racks.

53209-09 **\$699.95**
Leather Heritage Softail Classic Styling.

53690-06A **\$524.95**
Smooth Vinyl.

E. H-D® DETACHABLES™ TWO-UP TOUR-PAK LUGGAGE MOUNTING RACK

Designed to be installed and removed in less than 60 seconds, this Tour-Pak Rack makes the convenience and protection of a Leather Tour-Pak carrier an easy on/off proposition.

53066-00D **\$249.95**

Fits '00-'05 Softail models (except Deuce™), '06 FLST and FLSTF and '06-'17 FLSTC, FLSTN and FLSTSC models. Designed to accept Color-Matched Sport Tour-Pak or Leather Tour-Pak Luggage System. Requires separate purchase of appropriate Docking Hardware. Some models require the separate purchase of Directional Relocation Kit. Refer to Docking Hardware Chart for specific application. Some EU registration plates may interfere with Tour-Pak Rack. Models with rear fender tip trim can be adapted with the separate purchase of License Plate Relocation Kit P/N 60095-00A. Models equipped with H-D Detachables Saddlebag Kit P/N 88237-07 also require separate purchase of Docking Hardware Kit P/N 54245-10.

54051-08A **\$249.95**

Fits '07-'17 FLSTF, FLSTFB, FLSTFBS, FLSTSB and FXSTC, '06 FLSTFSE, '06-'15 FXST, FXSTB and FXSTS and '07-'08 FXSTSSE models. Designed to accept Leather Tour-Pak Luggage. Does not fit with Sport Tour-Pak Luggage. FXSTC models require removal of Original Equipment and separate purchase of appropriate docking hardware kit.

F. H-D DETACHABLES SOLO TOUR-PAK LUGGAGE MOUNTING RACK

Install the Sport or Leather Tour-Pak carrier in a comfortable back-supporting position. The rack is designed to position the Tour-Pak Luggage for solo riding and is adjustable over a .75" range. Simply remove the Tour-Pak Luggage from the convenient detachable hardware, add a Passenger Pillion and the bike is ready for two-up riding. Tour-Pak, Passenger Backrest Pad and Docking Hardware sold separately.

53559-04B **\$169.95**

Fits '00-'05 Softail models (except FXSTD). Fits '06 FLST, FLSTF and '06-'17 FLSTC, FLSTN, FLSTSC models. Designed to accept Color-Matched Sport Tour-Pak or Leather Tour-Pak Luggage System. Requires separate purchase of appropriate Docking Hardware. Some models require separate purchase of Directional Relocation Kit. See matrix for specific application. Some EU registration plates may interfere with the Tour-Pak Rack. Models with rear fender tip trim can be adapted with the separate purchase of License Plate Relocation Kit P/N 60095-00A.



E. H-D DETACHABLES TWO-UP TOUR-PAK LUGGAGE MOUNTING RACK (SHOWN WITH HERITAGE SOFTAIL CLASSIC TOUR-PAK)



F. H-D DETACHABLES SOLO TOUR-PAK LUGGAGE MOUNTING RACK (SHOWN WITH HERITAGE SOFTAIL CLASSIC TOUR-PAK)

SOFTAIL

Notice: The prices appearing in this catalog are the manufacturer's suggested retail prices. Actual retail prices may vary.

250 TWIN-CAM SOFTAIL®

Fuel Tank Panels & Luggage

A. PREMIUM TANK PANEL WITH POUCH

This leather tank panel features an over-sized pouch for convenient, at your fingertips storage. The heavy duty leather pouch will maintain its shape for miles to come while the bold chrome Bar & Shield medallion sits proudly on the flap for all to admire.

91135-09 \$99.95

Fits '93-'08 FXDWG, '06 FXD35, '07-'17 FXDC and FXDF and '00-'17 Softail® models (except FLS, FLSS, FLSTNSE, FLSTSB, FLSTSE, FXCW, FXCWC, FXS, FXSB, FXSBSE, FXSE, FXSTD, FXSTSSE, '09-'17 FLSTC and '06 FLSTFSE). '93-'03 FXDWG models require the separate purchase of Clip P/N 10102 and O-Ring P/N 11174.

B. LEATHER TANK PANEL WITH FAT BOY® CONCHO

Give your Softail® model additional attitude with this leather tank panel featuring an authentic Fat Boy® concho.

91134-01 \$59.95

Fits '93-'03 FXDWG and '00-'17 Softail models (except FLS, FLSS, FLSTNSE, FLSTSB, FLSTSE, FXCW, FXCWC, FXS, FXSB, FXSBSE, FXSE, FXSTD, FXSTSSE, '06 FLSTFSE and '09-'17 FLSTC).

C. DASH PANEL EXTENSION – CHROME

Stretch the lines of your chrome dash panel the full length of the fuel tank. This chrome-plated trim kit continues the lines and finishes of your standard tank panel to the front of the seat, adding a custom touch without the expense of a custom tank.

71283-01 \$41.95

Fits '00-'17 Softail models (except FLS, FLSS, FLSTNSE, FLSTSB, FLSTSE, FXCW, FXCWC, FXS, FXSB, FXSBSE, FXSE, FXST-Aus, FXSTD, FXSTSSE, '06 FLSTFSE and '09-'17 FLSTC models).

D. HANDLEBAR/FORK BAGS

Constructed of durable synthetic leather with embossed H-D Eagle Wing logo. Looks great on sissy bar uprights, handlebars and front forks.

If used in front fork application, fits '93-'17 FXDWG and '84-'17 FLSTC models. Also fits '82-'89 FXR with additional purchase of Directional Relocation Kit P/N 90504-82A.

91743-87T 11-inch length. \$34.95

91744-87T 8-inch length. \$29.95

E. LEATHER SISSY BAR/TOOL BAG

Heavy full-grain Latigo leather is specially tanned, oiled and waxed to withstand the elements. Identified with a custom Harley-Davidson® concho. 4.0" W x 4.0" D x 11.0" T.

91772-85A \$99.95

For use with FXDWG (except '10-'17 FXDWG with Original Equipment Sissy Bar) and FXSTC models only.

F. STUDDED LEATHER SISSY BAR BAG

Manufactured of durable full-grain Latigo leather and decorated with bright, chrome-plated studs.

91051-94 \$109.95



A. PREMIUM TANK PANEL WITH POUCH



B. LEATHER TANK PANEL WITH FAT BOY CONCHO



C. DASH PANEL EXTENSION – CHROME



D. HANDLEBAR/FORK BAGS



E. LEATHER SISSY BAR/TOOL BAG



F. STUDDED LEATHER SISSY BAR BAG

Notice: The prices appearing in this catalog are the manufacturer's suggested retail prices. Actual retail prices may vary.

TWIN-CAM SOFTAIL® 251

Luggage



G. SOFTAIL TOOLBOX – CHROME



G. SOFTAIL TOOLBOX – GLOSS BLACK



H. SOFTAIL TOOLBOX LINER



I. MUSIC PLAYER TANK POUCH

G. SOFTAIL® TOOLBOX

Add a traditional touch to your modern classic. Mirror chrome and gloss black teardrop-shaped Toolbox with latch provides just enough convenient storage space for your personal items. Kit includes chrome-plated mounting brackets and universal barrel-style locks with keys. Top-hinged toolbox accepts nylon Toolbox Liner P/N 91838-92 (sold separately) for packing ease.

64227-08 Right Hand, Chrome. **\$94.95**

Fits '08-'15 FXST, FXSTB and FXSTC models. All models require Spacer Kit P/N 49352-00 if used with Original Equipment passenger footpegs. Spacer kit not required with Passenger Footboard Kit P/N 50602-00A.

64216-09 Left Hand, Gloss Black. **\$94.95**

Fits '08-'17 FLS, FLSS, FLSTF, FLSTFB, FLSTFBS, FLSTSB, FXS, FXST, FXSTB and FXSTC and '08 FXSTSSE models. All models require Spacer Kit P/N 49352-00 if used with Original Equipment passenger footpegs. Spacer kit not required with Passenger Footboard Kit P/N 50602-00A. FLSTSB models require separate purchase of Screw P/N 94399-92T and Washer P/N 6595HB.

64230-08 Left Hand, Chrome. **\$94.95**

Fits '08-'17 FLS, FLSS, FLSTF, FLSTFB, FLSTFBS, FLSTSB, FXS, FXST, FXSTB and FXSTC and '08 FXSTSSE models. All models require Spacer Kit P/N 49352-00 if used with Original Equipment passenger footpegs. Spacer kit not required with Passenger Footboard Kit P/N 50602-00A. FLSTSB models require separate purchase of Screw P/N 94399-92T and Washer P/N 6595HB.

64938-00 Left Hand, Chrome. **\$94.95**

Fits '05-'07 FLST and FLSTN, '00-'06 FLSTF, '05 FLSTFSE and '00-'05 FXST, FXSTB and FXSTS models. All models (except FLSTN) require Spacer Kit P/N 49352-00 if used with Original Equipment passenger footpegs. Not required with Passenger Footboards P/N 50602-00A.

64937-00A Right Hand, Chrome. **\$94.95**

Fits '00-'07 FLST, FLSTN, FLSTC, FLSTS and FLSTSC and '00-'05 FXST, FXSTB and FXSTS models. All models (except FLSTN) require Spacer Kit P/N 49352-00 if used with Original Equipment passenger footpegs. Not required with Passenger Footboards P/N 50955-00 and 50602-00A. '00-'07 FLSTC models require Saddlebag Relocation Kit P/N 90238-00 with Original Equipment footpegs or footboards.

H. SOFTAIL TOOLBOX LINER

Made of tough 1000 denier nylon with silkscreened Bar & Shield logo. Features a full-length zipper and two elastic straps to secure several tools.

91838-92 **\$19.95**

Fits both left and right side toolboxes.

I. MUSIC PLAYER TANK POUCH

This portable music system pouch is designed for motorcycle use. The neoprene jacket offers hard-core protection for your portable music device, while the built-in magnets hold the pouch securely to the fuel tank. The clear play-through window permits touch-screen control and the anti-skid interior allows the pouch to accommodate players of various sizes. The clamshell design makes inserting your player into the pouch quick and easy and the double zipper allows for headphone and output cables to exit the pouch at any point on top, bottom or one side of the pouch. Simply plug in your headphones or connect your in-dash Advanced Audio Radio with an auxiliary cable or iPod® Interface and enjoy your music collection. Works well with many MP3 and other personal music players, but should not be used with hard-disk memory players. Window measurement: 2.25" W x 4.0" H.

76000193 **\$44.95**

Fits models with steel fuel tanks or airbox covers.

Notice: The prices appearing in this catalog are the manufacturer's suggested retail prices. Actual retail prices may vary.

252 TWIN-CAM SOFTAIL®

Suspension

A. PREMIUM RIDE CARTRIDGE FORK KIT

This Cartridge Fork Kit converts the standard Original Equipment front suspension into a high-performance suspension with superior ride quality. The Cartridge Fork Kit complements low and standard height rear shocks by providing a balanced suspension system capable of delivering superior ride characteristics. The front fork kit improves resistance to front brake dive, improves cornering and enhances bottoming control.

45500141 **\$349.95**
Fits '00-'17 FL Softail® models (except FLSTS, FLSTSB, FLSTSC, '06 FLSTFSE and '07 FLSTF).



A. PREMIUM RIDE CARTRIDGE FORK KIT

B. PROFILE® LOW FRONT SUSPENSION*

Designed by Harley-Davidson to lower the front fork approximately 1.0" while preserving ride quality. The kit includes springs that are progressively wound for a compliant, yet controlled ride. Must only be installed on vehicles equipped with low-profile rear suspension.

54758-07 **\$109.95**
Fits '07-'17 FLS, FLSS, FLSTC and FLSTN, '08-'17 FLSTF, FLSTFB, FLSTFBS and '14-'17 FLSTNSE models. FLSTC, FLS (AUS/BRZ/APC), FLSTF and FLSTF Special (Europe/UK) models must also be equipped with Profile® Low Rear Suspension Kit P/N 54651-05, 54652-05 or 54001-04A.



B. PROFILE LOW FRONT SUSPENSION – FL SOFTAIL

C. REAR LOWERING KIT*

Provides low cost alternative to buying complete shocks. This kit is for the rider that simply wants to lower their bike inexpensively and have some ride height adjustability. Kit will lower seat height up to 1.0".

54001-04A **\$104.95**
Fits '00-'17 Softail models (except FLS, FLSS, FLSTFB, FLSTFBS, FLSTFSE, FLSTN, FLSTNSE, FLSTSB, FLSTSE, FXCW, FXCWC, FXS, FXSB, FXSBSE, FXSE, FXSTD and FXSTSSE). Also fits '12-'17 FLS models in AUS, BRZ and APC markets. Does not fit models equipped with Profile Lowering Kits P/N 54651-05A, 54588-94 or 54652-05.



C. REAR LOWERING KIT

D. PROFILE LOW REAR SUSPENSION*

This suspension lowers the seat height approximately .75" while preserving ride quality. Spring and damping rates are tailored for Softail models to ensure a controlled ride. Shocks feature multi-staged damping to ensure optimal performance under varying conditions. Compatible with Profile Low Front Suspension.

54651-05 Chrome. **\$409.95**
Fits '00-'17 FLSTC, FLSTB, FLSTF, FLSTS, FXST, FXSTB, FXSTC and FXSTS models. Also fits '10-'17 Fat Boy® Special model in UK, Europe, Brazil and select international markets that are factory-equipped with standard-height rear suspension.



D. PROFILE LOW REAR SUSPENSION – CHROME

E. COMFORT FLEX REAR SHOCKS*

For the rider willing to exchange the low-profile, slammed look for improved ride comfort. Standard-length shocks raise the seat height of a factory-lowered bike approximately 1.0" and deliver an improved ride through a longer stroke. Spring rates and damping are tailored to ensure a controlled ride and optimal performance under varying conditions.

54000041 **\$304.95**
Fits '05-'17 FLS, FLSS, FLSTFB, FLSTFBS, FLSTN, FLSTNSE, '05-'06 FLSTFSE, '08-'11 FLSTSB, '10-'12 FLSTSE, '07-'09 FXSTSSE, '03 FXSTDSE, '04 FXSTDSE and '07 FXSTD. Stock on '00-'17 FL and FX models equipped with standard height rear shocks. Cannot be used on models equipped with Profile Low Front Suspension Kits.



E. COMFORT FLEX REAR SHOCKS



***WARNING:** The Profile Low Front Spring Kit cannot be used independently and must be used with the appropriate Profile Rear Shock Lowering Kit. Installation of any accessory suspension components may affect cornering clearance and jiffy stand operation. This could distract the rider, causing loss of control and death or serious injury.



***WARNING:** Installation of any accessory suspension components may affect cornering clearance and jiffy stand operation. This could distract the rider, causing loss of control and death or serious injury.

Notice: The prices appearing in this catalog are the manufacturer's suggested retail prices. Actual retail prices may vary.

TWIN-CAM SOFTAIL® 253

Foot Controls



F. EXTENDED REACH FORWARD CONTROL KIT – LEFT



F. EXTENDED REACH FORWARD CONTROL KIT – RIGHT



F. EXTENDED REACH FORWARD CONTROL KIT – CHROME



G. FORWARD CONTROL KIT FOR FL SOFTAIL MODELS



H. BILLET STYLE SHIFT LEVER – CHROME



H. BILLET STYLE SHIFT LEVER – EDGE CUT



H. BILLET STYLE SHIFT LEVER – SATIN BLACK



I. RIDER FOOTPEG HEEL REST

F. EXTENDED REACH FORWARD CONTROL KIT*

This kit extends the rider foot controls a full 3.0" forward of the stock location, providing the tall rider a comfortable riding position. This comprehensive kit includes everything necessary for installation. The chrome kit includes new chrome brake and shifter mounting assemblies, chrome shift rod and all necessary hardware. Black kit includes new black painted brake and shifter mounting assemblies, chrome shift rod and all necessary hardware. The kit is compatible with Original Equipment or accessory footpegs, brake and shift lever and brake pedal and shifter peg.

Fits '07-'15 FX Softail® models (except FXSB, FXSBSE and FXSTD). FXCW, FXCWC and FXS models must reuse Original Equipment footpegs. Not for use with accessory Shift Linkages. Separate purchase of model-specific rear brake line is required. NOTE: Extended Forward Control Kit is compatible with Engine Guard P/N 49078-04A only.

49171-08 Chrome. **\$549.95**

G. FORWARD CONTROL KIT FOR FL SOFTAIL® MODELS*

Stretch out and put your feet in the wind. Ideal for taller riders, this kit converts the standard FL Softail footboard controls to Original Equipment FX Softail forward controls. The resulting foot-forward riding position takes the long-limbed rider out of the upright flat-foot, knees-up stance and puts them in a relaxed laid-back posture. Kit includes left and right brackets, shift lever, brake lever and all necessary mounting hardware. Footpegs and brake pedal pad sold separately.

33909-08A **\$349.95**

Fits '07-'17 FLSTC, FLSTF (except FLS, FLSS, FLSTFB and FLSTFBS), FLSTN, FLSTSB and FLSTSC models. Requires separate purchase of appropriate footpeg kit. Compatible footpeg kits for FLSTC and FLSTF are P/N 50305-02, 50359-04, 50370-04, 50474-03, 50500-03, 50506-03, 50576-05, 50695-08 or 50935-07. FLSTN, FLSTSB and FLSTSC require separate purchase of stock FXCW footpegs with wear pegs (P/N 51327-08 Left Peg, 51323-08 Right Peg and 33130-07A Wear Peg (Qty 2)). Does not fit with Profile® Low Suspension.

Also available:

EXTENDED REACH FORWARD CONTROL REAR BRAKE LINE (NOT SHOWN)

Required for installation of Extended Reach Forward Control Kit P/N 49171-08 or 49223-08.

Fits '11-'15 FX Softail models equipped with Extended Reach Forward Control Kit P/N 49171-08 or 49223-08.

41800004 With ABS Brakes. **\$99.95**

41800005 Without ABS Brakes. **\$99.95**

44970-07 **\$99.95**

Fits '07 FX Softail models (except FXSTD) equipped with Extended Reach Forward Control Kit P/N 49171-08 or 49223-08.

H. BILLET STYLE SHIFT LEVERS

Styled to complement our billet style mirror stems, these Billet Style Shift Levers are forged from 6061-T6 aluminum, then machined and polished for a beautiful, custom look. Available in your choice of mirror chrome, satin black powder coat or edge cut black anodized and machined aluminum finishes. Includes chrome hardware. Shift pegs sold separately.

Fits '91-'17 Dyna® (except '14-'17 FXDL, FXDLS or models equipped with Further Forward Mid-Control Kit P/N 50500386) and '90-'17 FX Softail models.

34539-00 Chrome. **\$89.95**

34043-10 Edge Cut. **\$89.95**

34016-08 Satin Black. **\$89.95**

I. RIDER FOOTPEG HEEL REST

Give your feet a rest while you're stretching out on your forward controls. These adjustable Billet-Style Rider Footpeg Heel Rests reduce fatigue and make you look as good as you feel. Just add a pair of matching shifter pegs to complete the custom look (sold separately).

50227-01 **\$139.95**

Fits '93-'02 FXDWG and '89-'17 FX Softail models. Also fits Dyna models equipped with Forward Control Kit P/N 49080-06A, 49021-09 or 49080-93A.



***WARNING:** Installation of this kit may affect cornering clearance. This could distract the rider, causing loss of control, resulting in death or serious injury.

Notice: The prices appearing in this catalog are the manufacturer's suggested retail prices. Actual retail prices may vary.

254 TWIN-CAM SOFTAIL®

Foot Controls

A. BILLET STYLE HEEL/TOE SHIFT LEVER – EXTENDED REACH

Stretch out in style. Both the heel and toe sections of this Shift Lever are 1.0" longer than traditional levers, separating the distance between the heel/toe shift by 2.0" total. This added space provides a comfortable riding position for a tall rider and allows a rider with a large boot extra room to move. Styled to complement our billet style mirror stems, these Billet Style Shift Levers are forged, machined and polished for a beautiful, custom look. When combined with the available Extended Reach Brake Lever, long-limbed riders can straighten their legs and ride in comfort. Kit includes a front and rear lever and mounting hardware.

33600001 Chrome. **\$159.95**
Fits '86-'17 FL Softail®, '88-later Touring and '08-later Trike models.

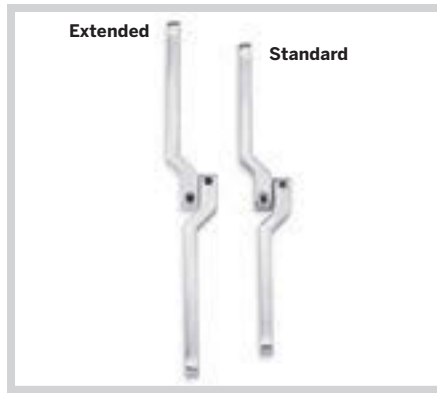

SHIFT LEVER COMPARE



A. BILLET STYLE HEEL/TOE SHIFT LEVER – EXTENDED REACH

B. BILLET STYLE HEEL/TOE SHIFT LEVER – STANDARD LENGTH

Styled to complement our billet style mirror stems, these Billet Style Shift Levers are forged from 7075-T6 aluminum, then machined and polished for a beautiful, custom look. Available in your choice of mirror chrome, satin black powder coat or edge cut black anodized and machined aluminum finishes. Kit includes a front and rear lever and chrome hardware.

Fits '86-'17 FL Softail, '88-later Touring and '08-later Trike models.

34535-00B Chrome. **\$159.95**
34045-10 Edge Cut. **\$159.95**
34023-08 Satin Black. **\$159.95**



B. BILLET STYLE HEEL/TOE SHIFT LEVER – STANDARD LENGTH, CHROME



B. BILLET STYLE HEEL/TOE SHIFT LEVER – STANDARD LENGTH, EDGE CUT

C. FOLDING HEEL SHIFTER

Give your left foot a little extra room. Folding Heel Shifter permits the rider to move the rear shift peg out of the way when on the open road, while retaining heel/toe shift functionality around town. Positive detent holds the peg in the selected position and can be adjusted while riding. Easy to install, the replacement rear lever is chrome-plated and shaped to match the Original Equipment toe shift lever. Lever accepts stock or accessory shifter peg.

33876-07 **\$79.95**
Fits '86-'17 FL Softail, '88-'16 Touring and '08-'16 Trike models.



B. BILLET STYLE HEEL/TOE SHIFT LEVER – STANDARD LENGTH, SATIN BLACK



C. FOLDING HEEL SHIFTER

D. HEEL/TOE SHIFTER SHAFT COVER

Conceal the splined end of the shifter shaft when you remove the heel shift lever. The easy-to-install chrome-plated aluminum billet cap is held in place with a flush Allen® screw for a clean look.

35471-05 **\$18.95**
Fits '82-'17 FL Softail®, and '82-later Touring and Trike models equipped with heel/toe shift levers. Installation requires removal of heel shift lever.



D. HEEL/TOE SHIFTER SHAFT COVER

E. HEEL/TOE SHIFTER SHAFT COVER WITH INSERT

Conceal the splined shifter shaft when you remove the heel shift lever. The kit includes a cover for the shaft end and an insert that conceals the casting and nylon spacer inboard of the shift lever. Manufactured from billet aluminum, these easy-to-install chrome-plated covers are held in place with flush Allen screws for a clean appearance.

35495-06 **\$34.95**
Fits '00-'17 FL Softail models (except FLSTSE) equipped with heel/toe shift levers. Installation requires removal of heel shift lever.



E. HEEL/TOE SHIFTER SHAFT COVER WITH INSERT

Notice: The prices appearing in this catalog are the manufacturer's suggested retail prices. Actual retail prices may vary.

TWIN-CAM SOFTAIL® 255

Foot Controls



F. GEAR SHIFTER LINKAGE COVER – HARLEY-DAVIDSON SCRIPT

F. GEAR SHIFTER LINKAGE COVERS

A simple and inexpensive way to detail your Softail® model. These easy-to-install chrome-plated covers conceal the stock shifter linkage for a brilliant finish. Kit includes all necessary mounting hardware.

46302-01 Harley-Davidson Script. **\$46.95**
Fits '99-'17 Softail® models (except FLSTSE) with stock shifter linkage.

G. CUSTOM GEAR SHIFT LINKAGE – ROUND GLOSS BLACK

Add the finishing touch to your blacked-out ride. This Gloss Black Shift Linkage is easy to install and includes a transmission lever cover and decorative acorn nuts and bolts for a complete custom look.

33600259 **\$99.95**
Fits '86-later Softail (except '18-later FXBB and FXLR), Touring and Trike models. (Does not fit '97-'99 FLSTS or models equipped with Softail Extended Reach Forward Controls.)



G. CUSTOM GEAR SHIFT LINKAGE – ROUND GLOSS BLACK

H. CUSTOM GEAR SHIFT LINKAGES

Kick your custom into gear with this collection of high quality custom shift linkages. Available in a variety of designs to match your bike's style, these linkages feature aircraft-quality rod ends for easy adjustment and smooth operation. The easy-to-install linkage kit also includes a transmission lever cover for '86-'17 Softail and '86-'16 Touring and Trike models, and decorative acorn nuts and bolts for a complete custom look.

Fits '86-later Softail, (except '18-later FXBB and FXLR), Touring and Trike models. (Does not fit '97-'99 FLSTS or models equipped with Softail Extended Reach Forward Controls.)

1. 34018-08	Slotted Black Anodized.	\$129.95
2. 34850-09	Skull.	\$129.95
3. 33801-09	Harley-Davidson Script.	\$129.95
4. 33760-09	Slotted with Bar & Shield Logo.	\$129.95
5. 33814-98A	Round.	\$89.95



H. CUSTOM GEAR SHIFT LINKAGES

Notice: The prices appearing in this catalog are the manufacturer's suggested retail prices. Actual retail prices may vary.

256 TWIN-CAM SOFTAIL®

Foot Controls

A. EXTENDED LENGTH RIDER RUNNING BOARDS

Stretching your legs and moving your feet during a long ride relieves muscle tension and reduces rider fatigue. At 4.0" longer (1.0" in front, 3.0" in back) and .5" wider than the Original Equipment rider footboards, these ergonomically friendly Running Boards provide plenty of space for riders to reposition their feet for maximum comfort. When used in conjunction with available Extended Brake and Shift Levers, the long legged rider will have even more room to stretch out on long rides. The easy-to-install kit includes left and right footboard pans with vibration-isolated inserts that are styled to complement the Crested Bar & Shield controls collection or most other chrome and rubber collections.

50500158 \$199.95

Fits '00-'17 FL Softail® (except FLS, FLSS, FLSTFB, FLSTFBS, FLSTN, FLSTNSE and FLSTSE or Softail models with Profile® Low Suspension). Also fits '00-later Touring (except FLHTCUL, FLHTCUL TC and FLHTKL) and '09-'13 Trike models. Not for use with Jiffy Stand Kit P/N 50000091 or Jiffy Stand Extension Kit P/N 50233-00, 50000008 and 50000023.



A. EXTENDED LENGTH RIDER RUNNING BOARDS

B. TAPERED RIDER FOOTBOARD KIT WITH CRESTED BAR & SHIELD LOGO INSERT

Long and lean, the tapered design of these footboards allows maximum flexibility in foot placement for added comfort on long rides. Kit includes left and right tapered footboard pans and rubber isolated deluxe inserts with smooth chrome surround. The inserts feature a slotted rubber design with embossed Bar & Shield logo. Original Equipment on Softail® Deluxe models.

50634-05 \$149.95

Fits '86-'17 FL Softail models.



Stock Length

A. EXTENDED LENGTH RIDER RUNNING BOARDS – COMPARISON TO STOCK SIZE



B. TAPERED RIDER FOOTBOARD KIT WITH CRESTED BAR & SHIELD LOGO INSERT (SHOWN WITH BRAKE PEDAL PAD)

C. HALF-MOON RIDER FOOTBOARDS

Combine the style of the '40s with the comfort of today. The classic half moon-shaped rider footboards are available in polished stainless steel or gloss black finish to complement your styling direction. The traditional Harley-Davidson® rubber insert features a vibration-isolation design for a long, comfortable ride. Kit includes left and right footboard pans and matching rubber inserts.

Fits '86-'17 FL Softail models.

51345-08 Polished Stainless Steel. \$154.95

51400-08 Gloss Black. \$154.95



C. HALF-MOON RIDER FOOTBOARDS – POLISHED STAINLESS STEEL



C. HALF-MOON RIDER FOOTBOARDS – GLOSS BLACK

D. RIDER FOOTBOARD HEEL GUARD

Avoid damaged boots and hours of cleaning melted rubber scuff marks from your exhaust shield. This Heel Guard mounts to the right-side rider footboard and protects your boot from contact with the hot exhaust shield. The subtle curved shape keeps the boot heel away without restricting fore-and-aft movement of the rider's foot. Kit includes chrome guard with cutaway Bar & Shield logo and all mounting hardware.

50500225 \$69.95

Fits '12-'16 FLD, '86-'17 FL Softail, '86-later Touring and '09-later Trike models equipped with Traditional and Swept Wing footboards. Does not fit models equipped with Half-Moon, Tapered, Airflow, Defiance or Burst footboards, Extended Reach Rider Footboards P/N 50409-04 or 54145-10, Rider Running Boards P/N 50500158 or Screamin' Eagle® Fat Exhaust Shield.



D. RIDER FOOTBOARD HEEL GUARD

Notice: The prices appearing in this catalog are the manufacturer's suggested retail prices. Actual retail prices may vary.

TWIN-CAM SOFTAIL® 257

Foot Controls



E. MINI FOOTBOARD KIT

E. MINI FOOTBOARD KITS

This Mini Footboard Kit can be installed in place of traditional footpegs and provides a little additional leg support and more options to move your feet around on a long run. Mini Footboards mount to standard H-D® style footpeg supports, and can be used in many rider and passenger applications. A little larger than a bicycle pedal, Footboards can be pivoted to the proper angle for maximum riding comfort.

Fits rider position:

'02-'17 VRSC™ models with forward controls (except VRSCDX and VRSCF), '06-earlier XL, '07-'10 XL883, XL883C, XL883R, XL1200C and XL1200R, '07-'11 XL1200L, '91-'17 Dyna® (except FLD), and '84-'17 Softail® models with forward controls (except FXCW, FXCWC, FXS, FXSB, FXSBSE and FXSE).

Fits passenger position:

All models with H-D male-mount passenger peg mounts (except '06-earlier VRSC, '03-earlier XL, '05-earlier Dyna and Softail models equipped with Shotgun exhaust). '84-'17 Softail models require separate purchase of Support Kit PN 50454-09. Does not fit passenger position on '18-later Softail models.

Fits highway peg position:

All models with frame-mount or engine guard-mount highway pegs (except Whiskers Adjustable Highway Bar P/N 50855-09 and 50865-09).

50500139	Small 3" – Chrome.	\$129.95
50500144	Small 3" – Gloss Black.	\$129.95
50500109	Large 4" – Chrome.	\$129.95
50500124	Large 4" – Gloss Black.	\$129.95



E. MINI FOOTBOARD KIT – 4"



E. MINI FOOTBOARD KIT – 3"



F. PASSENGER FOOTBOARD SUPPORT KIT

F. PASSENGER FOOTBOARD SUPPORT KIT

Required for installation of Mini Footboards in the passenger position on many Softail motorcycles.

50454-09		\$59.95
-----------------	--	----------------

Required for installation of Mini Footboards P/N 50451-09, 50500109, 50500124, 50500139, 50500144 on '08-'17 Softail models. Does not fit FLS, FLSS, FLSTF, FLSTFB, FLSTFBS, FLSTN, FLSTSB, FXS, FXSBSE, FXSTD and Softail models with shotgun exhaust. FLSTC and FLSTS models require the separate purchase of Saddlebag Bracket Relocation Kit P/N 90238-00.

G. PASSENGER FOOTPEG SUPPORTS – CHROME

Polished and plated to a mirror-finish, this chrome version of the Softail® Deluxe Original Equipment black passenger footpeg support complements any of the available passenger footpeg kits. When added to Softail Deuce™ and Fat Boy® models, this kit extends the passenger footpegs to allow folding without contacting the exhaust system.

51039-05		\$129.95
-----------------	--	-----------------

Fits '07-'17 Softail (except FLSTSC), '00-'06 FLSTF, FXS and FXSTD and '05-'17 FLSTN models with the separate purchase of (1) Screw P/N 4032A and (1) Screw P/N 4519. Also fits '08-'09 FXCW models with the additional purchase of (2) Screw P/N 4454 and (2) Spring Washer P/N 50912-72. Also fits '12-'17 FLS models with separate purchase of (1) Passenger Footpeg Mount Kit P/N 50932-08.



G. PASSENGER FOOTPEG SUPPORTS – CHROME



H. PASSENGER FOOTPEG MOUNT KIT

H. PASSENGER FOOTPEG MOUNT KIT

A necessary addition when converting your solo seat model to a two-up passenger-carrying ride. Kit includes black mounting brackets and all necessary mounting hardware. Footpegs sold separately.

50932-08		\$54.95
-----------------	--	----------------

Fits '12-'17 FLS, FLSS and '08-'11 FLSTSB models.

Notice: The prices appearing in this catalog are the manufacturer's suggested retail prices. Actual retail prices may vary.

258 TWIN-CAM SOFTAIL®

Foot Controls

A. CRESTED BAR & SHIELD PASSENGER FOOTBOARD AND MOUNT KIT

Styled to match the rider footboards on the Softail® Deluxe model, these Tapered Passenger Footboards feature a crested Bar & Shield logo rubber pad surrounded by a chrome accent. The footboard pan is chrome-plated throughout to add a custom touch, even in the folded position. Designed for convenient bolt-on installation, the complete kit includes aluminum footboards, rubber pads, mounting hardware and black footboard supports.

50377-07A \$329.95

Fits '07-'17 FLS, FLSS, FLSTN and FLSTSB models. Not for use with Pivot Bolt Covers or Chrome Rear Saddlebag Guards P/N 49360-08.



A. CRESTED BAR & SHIELD PASSENGER FOOTBOARD AND MOUNT KIT

B. PASSENGER FOOTBOARD AND MOUNT KITS

Add passenger comfort and support. These complete kits include specially designed mounting stud/brackets for convenient bolt-on installation. Footboards fold up when not in use. Available in your choice of Original Equipment or mirror-chrome finish, these kits include footboard pans, rubber pads, mounting hardware and matching chrome or black footboard supports. NOTE: Passenger Footboard Kits cannot be used with Pivot Bolt Covers.

Fits '00-'17 Softail® models (except FLS, FLSS, FLSTF, FLSTFB, FLSTFBS, FLSTN, FLSTNSE, FLSTS, FLSTSB, FLSTSC, FLSTSE, FXS, FXSBSE, FXCW, FXCWC and FXSTD). '00-'15 FLSTC models require Saddlebag Bracket Relocation Kit P/N 90238-00.

50602-00A Black. \$274.95

52715-04A Chrome. \$399.95

C. PASSENGER FOOTBOARD SUPPORT KITS

Add the comfort and convenience of passenger footboards to your Softail motorcycle. These support kits are designed to allow installation of traditional D-shaped, Swept Wing, Tapered or Old-Style Passenger Footboards (sold separately) on Softail models. Kit includes left and right supports, footboard mount hinge pins and installation hardware.

Fits '00-'17 Softail models (except FLS, FLSS, FLSTF, FLSTFB, FLSTFBS, FLSTN, FLSTNSE, FLSTS, FLSTSB, FLSTSC, FLSTSE, FXS, FXSBSE, FXCW, FXCWC and FXSTD). '00-'15 FLSTC models require Saddlebag Bracket Relocation Kit P/N 90238-00.

50459-06 Black. \$154.95

50460-06 Chrome. \$249.95

Fits '07-'17 FLSTF, FLSTFB, FLSTFBS, FXS and FXSTD models.

50399-07A Black. \$149.95

Fits '07-'17 FLS, FLSS, FLSTN and FLSTSB models. Not for use with Pivot Bolt Covers or Chrome Rear Saddlebag Guards P/N 49360-08.

50400-07A Black. \$149.95



B. PASSENGER FOOTBOARD AND MOUNT KIT – BLACK



B. PASSENGER FOOTBOARD AND MOUNT KIT – CHROME



C. PASSENGER FOOTBOARD SUPPORT KIT – BLACK (50459-06 SHOWN)



C. PASSENGER FOOTBOARD SUPPORT KIT – CHROME (50460-06 SHOWN)

Notice: The prices appearing in this catalog are the manufacturer's suggested retail prices. Actual retail prices may vary.

TWIN-CAM SOFTAIL® 259

Engine Guards



D. MUSTACHE ENGINE GUARD – CHROME



D. MUSTACHE ENGINE GUARD – GLOSS BLACK

D. MUSTACHE ENGINE GUARD*

Combine classic shape and modern function for a unique twist on engine protection. The flow of this engine guard complements the bike's traditional style while the gracefully curved upper section incorporates highway pegs into the shape. The integrated rubber pads offer a comfortable and slip-resistant cushion for your feet while traveling the open road. One-piece engine guard kit includes all required mounting hardware.

Fits '00-'17 FL Softail® models.

49140-05B	Chrome.	\$289.95
49440-10	Gloss Black.	\$289.95

E. ENGINE GUARD – CHROME*

Protect your bike without sacrificing ground clearance or style. The one-piece engine guard is designed to complement the lines of the motorcycle and the bright chrome finish adds the perfect finishing touch.

49004-00A **\$219.95**

Fits '00-'17 FL Softail models.

49200-07A **\$219.95**

Fits '00-'17 FX Softail models (except models equipped with Extended Reach Forward Control Kit P/N 49171-04 or 49223-04). FXSE models require the removal of the stock Original Equipment Chin Spoiler.

49004-90 **\$234.95**

Fits '86-'99 FL Softail models.



E. ENGINE GUARD – CHROME



F. ENGINE GUARD – GLOSS BLACK

F. ENGINE GUARD – GLOSS BLACK*

A serious finish for serious riders. Before a black powder coat, these engine guards get an extra layer of protection from an E-Coat dip. So go on and install Engine Guard Mount Footpegs because this finish will go the distance.

49023-02A **\$219.95**

Fits '00-'17 FL Softail models.

G. NOSTALGIC CURVED ENGINE GUARD – CHROME*

The nostalgic curved shape adds classic style to functionality. Reminiscent of the vintage 1940s style, the one-piece chrome Engine Guard complements the lines of the classic style Softail Deluxe, Heritage Softail® Classic and FL Springer™ models.

49037-05A **\$219.95**

Fits '00-'17 FL Softail models. Compatible with Engine Footpeg Mount Kit P/N 49102-86T or 49144-86.



G. NOSTALGIC CURVED ENGINE GUARD – CHROME



H. SOFT LOWERS

H. SOFT LOWERS

Extend your riding season. Full coverage Soft Lower provide wind and mud protection for the rider's legs and boots and minimize cold updrafts as the weather changes. Covers are custom shaped to hug the engine guard to minimize flapping and they simply clip in place for speedy installation as the weather changes. Two-way zippered outer edge accommodates guard-mounted highway pegs in almost any position. Reflective piping provides added visibility and the rigid inner panel provides ample clearance around the foot controls.

57100213 **\$114.95**

Fits '86-'17 FL Softail models equipped with Engine Guard P/N 49004-90 or 49004-00A. Does not fit Mustache or Nostalgic Engine Guards. Does not fit models with forward controls, Extended Reach Brake Lever or Extended Reach Shift Lever.



***WARNING:** Do not use highway pegs under normal stop and go operating conditions. Doing so could result in death or serious injury.



***WARNING:** Engine guards may provide limited leg and cosmetic vehicle protection under unique circumstances (fall over while stopped, very low speed slide). They are not made nor intended to provide protection from bodily injury in a collision with another vehicle or any other object.

Notice: The prices appearing in this catalog are the manufacturer's suggested retail prices. Actual retail prices may vary.

260 TWIN-CAM SOFTAIL®

Chassis Trim

A. REAR SADDLEBAG GUARDS – CHROME*

Saddlebag guards provide a style borrowed from the past that makes a unique statement here and now. Includes mounting hardware and instructions.

49261-00A **\$229.95**

Fits '00-'17 FLST and FLSTC and '00-'05 FXST, FXSTB and FXSTS models. FLSTC models require Saddlebag Relocation Kit P/N 90238-00.

49360-08 **\$229.95**

Fits '05-'17 FLSTN models. Does not fit FLSTNSE models. Fits with Saddlebag Kit P/N 88286-07 and 53015-05B. Does not fit with Passenger Footboard Kits. Does not fit with Tool Box Kit P/N 64937-00A or 64938-00.

Also available:

SADDLEBAG BRACKET RELOCATION KIT (not shown)
Required for installation of FLSTS Rear Saddlebag Guards P/N 49258-00A and FLSTC Rear Saddlebag Guard P/N 49261-00.

90238-00 **\$14.95**

Fits '00-'17 FLSTC, FLSTS and FLSTSB models.



A. REAR SADDLEBAG GUARDS – CHROME
(49261-00A SHOWN)



A. REAR SADDLEBAG GUARDS – CHROME
(49360-08 SHOWN)

B. WHISKERS ADJUSTABLE HIGHWAY BAR*

Stretch your legs and change riding position while you rack up the miles. Frame-mounted bar can be pivoted fore and aft to accommodate your inseam length and locks in place with a common Allen® wrench. The easy-to-install bar features a three-point mounting system that grips both down tubes. Highway Bar accepts your choice of H-D® style male-mount footpegs (sold separately). Available in mirror chrome or gloss black finish.

Fits '00-'17 Softail® models (except FXCW, FXCWC, FXS, FXSB, FXSBSE and FXSE) without ABS. Also fits '14-'15 FLSTNSE when Original Equipment engine guard is removed. Does not fit with Boom!™ Audio Cruiser Amp and Speaker Kit P/N 76262-08A, 76320-08A, 76321-09A, Heel Raiser Footpeg Kit P/N 50178-09 or Mini Footboard Kits P/N 50500109, 50500124, 50500139, 50500144 or 50451-09.

50855-09 Chrome. **\$209.95**

50865-09 Gloss Black. **\$209.95**



B. WHISKERS ADJUSTABLE HIGHWAY BAR –
GLOSS BLACK



B. WHISKERS ADJUSTABLE HIGHWAY BAR

C. JIFFY STAND EXTENSION

Jiffy Stand Extension kits have been ergonomically designed to simplify the deployment and retraction of the jiffy stand. The extension is shaped to simplify locating the tab with your boot and aid in swinging the jiffy stand into position. The move feels natural and adds confidence when parking your motorcycle in a tight spot. Kit mounts to Original Equipment jiffy stand and includes all required mounting hardware.

50000008 **\$44.95**

Fits '07-'17 Softail models (except FLS, FLSS, FLSTN, FLSTNSE, FLSTSE, FXSB, FXSBSE, FXSE, '10-'17 FLSTFB and FLSTFBS and '09 FXSTSSE). Does not fit models equipped with Defiance footboards, Burst footboards or Rider Running Boards P/N 50500158.

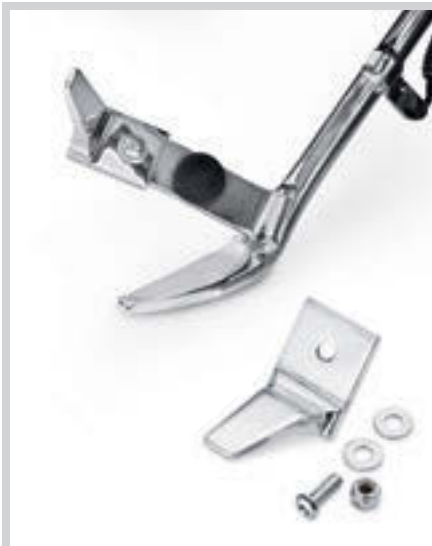

C. JIFFY STAND EXTENSION



D. ERGO JIFFY STAND

D. ERGO JIFFY STAND

This Ergonomic Jiffy Stand has been engineered to simplify the deployment and retraction of the side stand. The jiffy stand features a ball-tipped extension that is shaped to simplify locating the tab with your boot and aid in swinging the jiffy stand into position. The move feels natural and adds confidence when parking your motorcycle in a tight spot. Kit replaces Original Equipment jiffy stand and includes stand bumper, bushing and all required mounting hardware.

50000091 **\$99.95**

Fits '07-'17 Softail models (except FXSB, FXSBSE and FXSE). Stock on '15-'17 FLS, FLSS, FLSTFB, FLSTFBS, FLSTN and FLSTNSE models. Does not fit models equipped with Defiance footboards, Burst footboards or Rider Running Boards P/N 50500158.



***WARNING:** Do not use highway pegs under normal stop and go operating conditions. Doing so could result in death or serious injury.

Notice: The prices appearing in this catalog are the manufacturer's suggested retail prices. Actual retail prices may vary.

TWIN-CAM SOFTAIL® 261

Chassis Trim – Front End



E. FRONT END KIT – CHROME (FAT BOY SHOWN)



E. FRONT END KITS – CHROME

The front forks on a Harley-Davidson® motorcycle set the tone for the bike and can lead the way to a full-bore custom statement. So start customizing by adding chrome where it will have the most noticeable impact on the overall look of the bike, the front end. A perfect addition during the installation of Premium Ride or Profile® Low Front suspension components, this kit includes components necessary to completely chrome the front forks and includes some or all of the following (Kit components vary depending on your model): Chrome Fork Sliders, Oil Seals, Chrome Fork Axle Retainer Nut Kit, Chrome Fork Slider Drain Screw Kit, Classic Chrome Front Axle Nut Cover Kit and Chrome Upper Fork Nut Covers. Chrome Front End Package price does not include labor or supplies.

45400006 \$649.95

Fits '12-'17 FLS, FLSS, FLSTF, FLSTFB and FLSTFBS, '09-'17 FLSTC and '07-'17 FLSTN models. Also fits '07-'08 FLSTC with separate purchase of front fork cover P/N 67830-09.

F. LOWER FORK SLIDERS – CHROME

Competitively-priced, these chrome-plated Lower Fork Sliders give your bike upfront style. To ensure proper fitment and function, these sliders are manufactured from Original Equipment components. Form follows function, with polished, chrome-plating and a stamped Harley-Davidson logo for product identification. A perfect addition during the installation of Premium Ride or Profile Low Front suspension components, this kit includes right and left sliders and the bottom axle retainer. '07-later model kits also include chrome drain screws, axle retainer bolts and oil seals.

45500014 \$449.95

Fits '07-'17 FLS, FLSS, FLSTC and FLSTN and '08-'17 FLSTF, FLSTFB and FLSTFBS models.

46482-00 \$449.95

Fits '00-'06 FLST, FLSTC, FLSTF and FLSTN models.

45310-98 \$449.95

Fits '86-'99 FLSTC, FLSTF and FLSTN models.

46477-00 \$449.95

Fits '00-'05 FXDWG and '00-'06 FXST and FXSTB models.

G. LOWER FORK SLIDERS – GLOSS BLACK

These gloss black coated sliders are the ultimate extension of your bike's "dark side" and make a perfect custom addition to your blacked-out FL Softail® model. Manufactured to Original Equipment specifications, the durable black coating is a great match to other H-D® black components. Add matching Gloss Black Upper Fork Slider Covers P/N 45591-02 for a complete look. A perfect addition during the installation of Premium Ride or Profile Low Front suspension components, this includes right and left sliders, bottom axle retainers, drain screws, axle retainer bolts and oil seals.

45500015 \$449.95

Fits '07-'17 FLS, FLSS, FLSTC, FLSTN and FLSTNSE, '08-'17 FLSTF, FLSTFB, FLSTFBS and '10-'12 FLSTSE models.



F. LOWER FORK SLIDERS – CHROME



G. LOWER FORK SLIDERS – GLOSS BLACK



SOFTAIL

Notice: The prices appearing in this catalog are the manufacturer's suggested retail prices. Actual retail prices may vary.

262 TWIN-CAM SOFTAIL®

Chassis Trim – Front End

A. UPPER FORK SLIDER COVERS – CHROME

Brilliant chrome accents for the upper fork legs. Perfect for finishing off that chromed front end look. When used with H-D® Genuine Motor Accessory Chrome Lower Fork Sliders, you've got a front end that's completely chromed and an appearance that's utterly impressive.

45963-97 **\$79.95**

Fits '49-'84 FL, '86-'17 FLS, FLSS, FLST, FLSTC, FLSTF (except '07), FLSTFB, FLSTFBS and FLSTN and '80-'13 Touring and Trike models. Stock on FLSTNSE and FLSTSE models.



A. UPPER FORK SLIDER COVERS – CHROME

B. UPPER FORK SLIDER COVERS – GLOSS BLACK

The classic Harley-Davidson® motorcycle color is black. It shows your attitude, your feelings and your desire to be different from the rest. These gloss black accessories are the ultimate extension of the Harley-Davidson philosophy. Manufactured from Original Equipment components, these parts provide superior fit and finish.

45591-02 **\$79.95**

Fits '49-'84 FL, '86-'17 FLS, FLSS, FLST, FLSTC, FLSTF (except '07), FLSTFB, FLSTFBS, FLSTNSE and FLSTN, '10-'12 FLSTSE and '80-'13 Touring and Trike models.



B. UPPER FORK SLIDER COVERS – GLOSS BLACK

C. FORK COVER MEDALLIONS – BURST COLLECTION

These 5" medallions feature a curved mounting surface that fit perfectly to Upper Fork Slider Covers. Includes a slider cover mounting template. Easy to install. Sold in pairs.

14100434 **\$64.95**

Fits '49-'84 FL, '86-'17 FLST, FLSTC, FLSTF (except '07), FLSTFB, FLSTFBS and FLSTN, '10-'11 FLSTSE '18-later FLDE, FLFB, FLFBS, FLHC, FLHCS, FLSL and '80-later Touring and Trike models.



C. FORK COVER MEDALLIONS – BURST COLLECTION

D. FRONT FENDER HARDWARE KIT – CHROME

Finish the show-winning look with brilliant chrome hardware. Manufactured to Original Equipment specifications, this kit replaces the zinc-plated exposed front fender mounting bolts with chrome-plated socket head cap screws.

94415-05 **\$9.95**

Fits '93-'05 FXDWG and '91-'17 Softail® models (except Springer™, FXCW, FXCWC, FXSB, FXSBSE, FXSE and FXSTD). Does not fit with Billet Fork Slider Kit or Inverted Front End Kit.



D. FRONT FENDER HARDWARE KIT – CHROME

Notice: The prices appearing in this catalog are the manufacturer's suggested retail prices. Actual retail prices may vary.

TWIN-CAM SOFTAIL® 263

Chassis Trim – Front End



E. TEARDROP FRONT FORK ROCKER COVER KIT

E. TEARDROP FRONT FORK ROCKER COVER KIT

Nostalgic chrome-plated styling that seems to be in constant motion. Easily installs on Heritage Springer® models without removing wheel.

43161-97 **\$69.95**
Fits '97-'03 FLSTS and '05-'07 FLSTSC models.

F. ABS FRONT WHEEL SPACERS

It is all in the details. Complete your total front end with these wheel spacers in mirror chrome finish. Manufactured to the Original Equipment tolerances, they deliver the exact fitment and custom shine. Chrome is Original Equipment on FLSTNSE

43300010 Chrome. **\$49.95**
Fits '11-'17 FLS, FLSS, FLSTF, FLSTC and FLSTN models with ABS brakes. FLSTC and FLSTN models require removal of Original Equipment hub cap.

G. ABS HARNESS COVER – CHROME

Dress your ABS-equipped Softail model in style. Shaped to conceal the ABS wheel speed sensor harness, this bracket mounts to the brake caliper tabs on the lower fork sliders. The mirror chrome finish complements the Original Equipment satin polished sliders or serves as the final finishing touch to a complete chrome front end.

32700002 **\$37.95**
Fits '11-'17 Softail® models (except FXCWC, FXSB and FXSBSE) equipped with ABS.

H. CUSTOM FORK BRACE

This chrome-plated Fork Brace adds style to the front end. The cross-brace open web style reflects a performance heritage and the multi-piece design allows easy installation.

46097-98 41mm. **\$159.95**
Fits '93-'05 FXDWG and '84-'17 FX Softail models (except Springer™, FXCW, FXCWC, FXS, FXSB, FXSBSE, FXSE and FXSTD). (Will not fit with Chrome Lower Fork Sliders.)

I. REAR MASTER CYLINDER COVER – CHROME

An easy way to add chrome to your bike is with this chrome-plated version of the stock master cylinder cover.

46425-05A **\$39.95**
Fits '06-'17 Dyna® non-ABS models, '06-'17 Softail and '05-'07 Touring models.

45149-99C **\$39.95**
Fits '00-'05 Softail and '99-'04 Touring models.



F. ABS FRONT WHEEL SPACERS – CHROME



G. ABS HARNESS COVER – CHROME



H. CUSTOM FORK BRACE



I. REAR MASTER CYLINDER COVER – CHROME

Notice: The prices appearing in this catalog are the manufacturer's suggested retail prices. Actual retail prices may vary.

264 TWIN-CAM SOFTAIL®

Chassis Trim – Front End

FRONT AXLE NUT COVERS

Cover the front axle in style. Available in your choice of styles, these custom Axle Nut Covers look great with Original Equipment satin-finish fork sliders or add the finishing touch to a complete chrome or blacked-out front end. Easy to install kits include all necessary mounting hardware. Sold in pairs.

Fits '02-'11 VRSC™ (except VRSCF and VRSCR), '15-later XG, '08-later XL, '08-'17 Dyna®, '07-later Softail® (except Springer™, FLSTNSE, FXCW, FXCWC, FXSB, FXSBSE, FXSE, FXST-Aus, and FXSTD) and '08-later Touring and Trike models. '18-later FLDE, FLFB, FLFBS, FLHC, FLHCS, FLSE, FLSEB, FLSEB, FXBB, FXBR, FXBRS and FXLR models require separate purchase of Front Axle Adapter Kit P/N 43000090. '19-later FXDRS and '18-later FXFB and FXFBS models require separate purchase of Front Axle Adapter Kit P/N 43000159.

A. DOMINION™ COLLECTION FRONT AXLE NUT COVERS

Express your bold, renegade attitude. The machined aluminum Dominion™ Collection Front Axle Nut Covers add style to the front of the bike and are the perfect complement to other Dominion Collection accessories.

43000124	Gloss Black.	\$74.95
43000123	Bronze.	\$74.95

B. DEFIANCE COLLECTION FRONT AXLE NUT COVERS

Start a new tradition. Deep radial grooves and a contemporary H-D logo define the style Defiance Collection Front Axle Nut Covers. Available in your choice of chrome or black machine cut finish, these easy to install elements complement polished, chrome or blacked-out front end components. Sold in pairs.

43000062	Chrome.	\$74.95
43000064	Black Machine Cut.	\$74.95

C. H-D MOTOR CO. LOGO FRONT AXLE NUT COVERS

Die-cast, chrome-plated covers feature the Harley-Davidson Motor Co. logo in black. Includes Allen®-head set screws and wrench for easy installation.

44148-07A		\$31.95
------------------	--	----------------

D. BURST COLLECTION FRONT AXLE NUT COVERS

Finish your blacked-out forks in style. Rich black and prismatic machined surfaces provide the contrast and the race-track ridges and the inner spider design make a powerful visual statement. Easy to install kit includes mounting hardware.

43000031		\$69.95
-----------------	--	----------------

E. CHROME FRONT AXLE NUT COVERS

444117-07A	Die-cast.	\$29.95
44116-07A	Billet.	\$44.95

F. GLOSS BLACK FRONT AXLE NUT COVERS

43000026	Die-cast.	\$29.95
43428-09	Billet.	\$44.95



A. DOMINION FRONT AXLE NUT COVERS – GLOSS BLACK



A. DOMINION FRONT AXLE NUT COVERS – BRONZE



B. DEFIANCE COLLECTION FRONT AXLE NUT COVERS – CHROME



B. DEFIANCE COLLECTION FRONT AXLE NUT COVERS – BLACK MACHINE CUT



C. H-D MOTOR CO. LOGO FRONT AXLE NUT COVERS



D. BURST COLLECTION FRONT AXLE NUT COVERS



E. CHROME FRONT AXLE NUT COVERS



F. GLOSS BLACK FRONT AXLE NUT COVERS

Notice: The prices appearing in this catalog are the manufacturer's suggested retail prices. Actual retail prices may vary.

TWIN-CAM SOFTAIL® 265

Chassis Trim – Front End



G. FRONT AXLE NUT COVERS – SATIN CHROME



H. ALUMINATOR FRONT AXLE NUT COVERS

G. FRONT AXLE NUT COVERS – SATIN CHROME

Cover the front axle in style. The rich satin chrome finish of these Front Axle Covers is the perfect match for the satin-finished components on the '18 Fat Boy® model, and a great complement to Original Equipment polished or blacked-out fork sliders as well. Easy to install kits include all necessary mounting hardware. Sold in pairs.

43000098 **\$29.95**

H. ALUMINATOR® FRONT AXLE NUT COVERS

Chrome-plated billet aluminum axle covers feature a classic Bar & Shield logo insert. Includes all necessary mounting hardware for easy installation.

44114-07 **\$44.95**

I. WILLIE G SKULL FRONT AXLE NUT COVERS

Penned at the hand of Willie G, the famous Skull Collection adds a little attitude to your ride. Completely drenched in black or chrome with black filled accents, the raised skull and surrounding Harley-Davidson® Motorcycle script adds a subtle ominous touch to your ride. The Axle Nut Covers are easy to install and include all necessary mounting hardware. Sold in pairs.

Fits '02-'11 VRSC™ (except VRSCF and VRSCR), '15-later XG, '08-later XL (except '16-later XL1200X and XL1200XS), '08-'17 Dyna®, '07-later Softail® (except Springer™, FLSTNSE, FXCW, FXCWC, FXSB, FXSBSE, FXSE, FXST-Aus, and FXSTD) and '08-later Touring and Trike models. '18-later FLDE, FLFB, FLFBS, FLHC, FLHCS, FLFL, FXBB, FXBR, FXBRS and FXLR models require separate purchase of Front Axle Adapter Kit P/N 43000090. '19-later FXDRS and '18-later FXFB and FXFBS models require separate purchase of Front Axle Adapter Kit P/N 43000159.

43000096 Black. **\$34.95**

43163-08A Chrome. **\$34.95**

K. FRONT AXLE NUT COVERS – BRASS COLLECTION

Artistically manufactured from solid brass, these components feature a natural antique finish that will age and patina when exposed to the elements. Brass Collection Axle Nut Covers look great with Original Equipment satin-finish fork sliders or as the finishing touch to a blacked-out front end. Easy to install kits include all necessary mounting hardware. Sold in pairs.

43000046 **\$54.95**

Fits '02-'11 VRSC (except VRSCF and VRSCR), '15-later XG, '08-later XL (except '16-later XL1200X and XL1200XS), '08-'17 Dyna, '07-later Softail (except Springer, FLSTNSE, FLFB, FXCW, FXCWC, FXDRS, FXFB, FXFBS, FXSB, FXSBSE, FXSE, FXST-Aus, and FXSTD) and '08-later Touring and Trike models. FLDE, FLFB, FLFBS, FLHC, FLHCS, FLFL, FXBB, FXBR, FXBRS and FXLR models require separate purchase of Front Axle Adapter Kit P/N 43000090.



I. WILLIE G SKULL FRONT AXLE NUT COVERS – GLOSS BLACK



I. WILLIE G SKULL FRONT AXLE NUT COVERS – CHROME



J. FRONT AXLE NUT COVERS – BRASS COLLECTION



SOFTAIL

Notice: The prices appearing in this catalog are the manufacturer's suggested retail prices. Actual retail prices may vary.

266 TWIN-CAM SOFTAIL®

Chassis Trim – Front End

A. FREIGHT TRAIN HEADLIGHT NACELLE

If the shape of this nacelle seems to reflect the image of the 1960s FL models, that's because the spirit of the past is built right in. Bold locomotive styling adds visual strength to the bike's profile and stretches the rider's view to the horizon when looking over the headlamp. Coupled with the separate purchase of the Nacelle Hardware Kit P/N 67897-96B, the nacelle fits with an existing H-D® windshield and/or passing lamps. Kit includes hardware required for installation of the nacelle with a detachable windshield without passing lamps. Separate Hardware Kit is required when installing nacelle with passing lamps or rigid mount windshield.

Fits '86-'17 FLST, FLSTF, FLSTFB, FLSTFBS and FLSTC models. '07-'17 FLSTF, FLSTFB and FLSTFBS models with Original Equipment 1.25" handlebar require separate purchase of Riser Kit P/N 56789-05. '09-'17 FLSTC models with Original Equipment 1.0" handlebar requires separate purchase of Riser Kit P/N 46809-09.

61300420 Chrome. **\$449.95**

61300421 Gloss Black. **\$449.95**

Also available:

RISER KIT FOR FREIGHT TRAIN HEADLIGHT NACELLE

Required for installation of Freight Train Headlamp Nacelle.

46809-09 For 1.0" Handlebar. **\$99.95**

Required for installation of Freight Train Headlight Nacelle Kit P/N 61300420 or 61300421 on '09-'17 FLSTC models with Original Equipment or accessory 1.0" handlebar. Also required for '07-'17 FLSTF, FLSTFB and FLSTFBS models equipped with accessory 1.0" handlebars.

56789-05 For 1.25" Handlebar. **\$139.95**

Required for installation of Freight Train Headlight Nacelle Kit P/N 61300420 or 61300421 on '07-'17 FLSTF, FLSTFB and FLSTFBS models with Original Equipment 1.25" handlebar. Also required for '86-'17 FLST, FLSTF, FLSTFB, FLSTFBS and FLSTC models equipped with accessory 1.25" handlebars.

B. FORK COVER ACCENT STRIPS – GLOSS BLACK

These strips are designed to add the ultimate complement to the Gloss Black Fork Cover Kit. Finished in matching rich black, these extruded aluminum pieces fill the gap between the front and rear covers that is created when the passing lamps are removed. Strips are sold individually and two are required for a complete installation.

68055-10BHP **\$19.95**

Fits '86-'17 FLS, FLSS, FLST, FLSTC, FLSTF, FLSTFB and FLSTFBS '93-'96 FLSTN models with Gloss Black Fork Cover Kit P/N 48608-09. (Does not fit with passing lamps or windshields.)

Shown with:

HEADLAMP SHELL – GLOSS BLACK

Add to the sinister look of your blacked-out Softail® motorcycle. Manufactured from Original Equipment components, this gloss black headlamp housing replaces the chrome headlamp shell for a custom look. Shell includes wiring harness and connector and accepts the Original Equipment headlamp, trim ring and mounting hardware.

73294-10 **\$199.27**

Fits '86-'17 FLS, FLSS, FLST, FLSTC, FLSTF, FLSTFB and FLSTFBS and FLSTN models in domestic and right-hand drive markets.



A. FREIGHT TRAIN HEADLIGHT NACELLE – CHROME



A. FREIGHT TRAIN HEADLIGHT NACELLE – GLOSS BLACK



B. ACCENT STRIPS AND HEADLAMP SHELL

Notice: The prices appearing in this catalog are the manufacturer's suggested retail prices. Actual retail prices may vary.

TWIN-CAM SOFTAIL® 267

Chassis Trim – Front End



C. FORK COVER KIT – CHROME



C. FORK COVER KIT – CHROME

Replace your factory-original satin fork covers with these brilliant, triple chrome-plated versions for a custom mirror-like shine.

67890-91C **\$139.95**

Fits '86-'08 FLST, FLSTF and FLSTFB and '93-'17 FLSTN models. Does not fit FLSTC with Original Equipment light bar or models with Auxiliary Lighting Kit P/N 69287-07 or 68000026.

D. FORK COVER SIDE PANELS – CHROME

Complete the chrome finish of the Softail® Deluxe model Fork Cover. These side panels replace the polished panels that wrap around the rear of the triple tree. Easy to install, this kit includes left and right side panels.

66441-05 **\$64.95**

Fits '09-'17 FLS, FLSS and FLSTC, '07-'17 FLSTF, FLSTFB, FLSTFBS and '05-'17 FLSTN models. Stock on FLSTNSE.

E. FORK COVER ACCENT STRIP KIT – CHROME

Sometimes the best ideas come from you, our fellow riders, like this chrome accent strip. This kit is designed to add the ultimate complement to the already popular Chrome Fork Cover Kit by accenting the sides with beautiful chrome-plated aluminum strips. Kit includes chrome hardware.

67891-99 **\$29.95**

Fits '86-'11 FLSTF and FLSTFB and '93-'96 FLSTN models with Chrome Fork Cover Kit P/N 67890-91C or 66440-05. Stock on '12-'17 FLS, FLSTF and FLSTFB. Does not fit with passing lamps and windshields.

F. TIE-DOWN BRACKETS – CHROME

Simplify the process of securing your bike to a trailer or bike lift. These stylish chrome Tie-Down Brackets mount cleanly to the front fork cover and offer a secure method to connect tie-down straps. Moving the tie-down point from the handlebar to the triple tree area reduces wear on the handlebar bushings and ensures a consistent easy-to-access mounting point. Just add Harley-Davidson® Ratchet Straps and Soft Hooks and you're ready to go.

93500006 **\$64.95**

Fits '02-'17 FLS, FLSS, FLSTC, FLSTF, FLSTFB and FLSTFBS, '95-later FLHR, FLHRC and FLHRXS, '95-'13 FLHT, FLHTC and FLHX, '10-'13 FLHTCU and FLHTK, '10-'12 FLHXSE and '09-'12 FLHTCUSE. FLS, FLSS, FLSTF, FLSTFB and FLSTFBS models without a windshield require separate purchase of Hardware Kit P/N 91800030.

Shown with:

TIE-DOWN BRACKET HARDWARE KIT

Kit includes 4 button-head bolts required for installation of Chrome Tie-Down Brackets P/N 93500006 on specified models.

91800030 **\$9.95**

Required for installation of Chrome Tie-Down Bracket Kit P/N 93500006 on '00-'17 FLS, FLSS, FLSTF, FLSTFB and FLSTFBS models without windshields.



D. FORK COVER SIDE PANELS – CHROME



E. FORK COVER ACCENT STRIP KIT – CHROME



F. TIE-DOWN BRACKETS – CHROME

Notice: The prices appearing in this catalog are the manufacturer's suggested retail prices. Actual retail prices may vary.

268 TWIN-CAM SOFTAIL®

Chassis Trim – Front End

A. DOMINION™ COLLECTION FORK NUT COVERS

Top it off with style. These easy to install Fork Stem Covers top of the triple tree for a cohesive look. A perfect complement to other Dominion™ Collection Accessories, these Fork Nut Covers provide the finishing touch to your bike's front end. Sold in pairs.

Fits '06-'17 Dyna® models (except FXDB and FXDSE) and '18-later Softail® models (except FXDRS, FXFB, FXFBS, and FLSB). Also fits '88-'13 XL (except XL1200CX, XL1200X, XL883N) '95-'05 FXD, '93-'05 FXDL, '16-later FXDLS, '94-'05 FXDS-CONV, '90-'17 FLS, FLSS, FLSTF, FLSTFB, FLSTFBS and FLSTN, and '86-'17 FLSTC models.

45800117	Gloss Black.	\$74.95
45800118	Bronze.	\$74.95



A. DOMINION FORK NUT COVERS – GLOSS BLACK



A. DOMINION FORK NUT COVERS – BRONZE

B. DEFIANCE COLLECTION UPPER FORK STEM COVERS

Top it off with style. These easy to install Fork Stem Covers continue the Defiance Collection to the top of the triple tree for a cohesive look. The deep radial grooves define the style of the Defiance Collection, and the choice of chrome, black or machine cut complement your bike's polished, chrome or blacked-out front end components. Sold in pairs.

Fits '06-'17 Dyna models and '18-later Softail models (except FXDRS, FXFB, FXFBS, and FLSB). Also Fits '88-'13 XL (except XL1200CX, XL1200X, XL883N) '95-'05 FXD, '93-'05 FXDL, '16-later FXDLS, '94-'05 FXDS-CONV and '90-'17 FLS, FLSS, FLSTF, FLSTFB, FLSTFBS and FLSTN and '86-'17 FLSTC models

45500514	Chrome.	\$49.95
45500515	Gloss Black.	\$49.95
45500516	Black Machine Cut.	\$59.95



B. DEFIANCE COLLECTION UPPER FORK STEM COVERS – CHROME



B. DEFIANCE COLLECTION UPPER FORK STEM COVERS – GLOSS BLACK

C. UPPER FORK NUT COVERS – CHROME

Highlighted with a unique Bar & Shield logo, these polished triple chrome-plated covers add an additional clean looking appearance to your upper fork. Kit comes complete with three covers, mounting hardware and wrench for easy, on-the-spot installation.

46129-98B **\$59.95**

Fits '06-'17 Dyna models (except FLD, FXDB and FXDSE), '88-'13 XL (except XL883C, XL1200C and XL1200S), '95-'05 FXD, '93-'05 FXDL, '16-'17 FXDLS, '94-'05 FXDS-CONV and '90-'17 FLS, FLSS, FLSTF, FLSTFB, FLSTFBS and FLSTN and '86-'17 FLSTC models.



B. DEFIANCE COLLECTION UPPER FORK STEM COVERS – BLACK MACHINE CUT



C. UPPER FORK NUT COVERS – CHROME

D. UPPER FORK STEM COVERS – BRASS COLLECTION

The ideal addition to your stripped down bobber or café bike build, these easy-to-install solid brass covers hide the Original Equipment fork and steering stem hex-head hardware and add a clean custom touch. Artistically manufactured from solid brass, these Upper Fork Covers feature a natural antique finish that will age and patina when exposed to the elements. Kits includes mounting hardware.

45500308 Three-Piece Kit. **\$79.95**

Fits '88-'13 XL (except XL883C, XL1200C and XL1200S), '95-'05 FXD, '93-'05 FXDL, '94-'05 FXDS-Conv, and '90-'17 FLS, FLSS, FLSTF, FLSTFB, FLSTFBS, and FLSTN and '86-'17 FLSTC models.



D. UPPER FORK STEM COVERS – BRASS COLLECTION



Notice: The prices appearing in this catalog are the manufacturer's suggested retail prices. Actual retail prices may vary.

TWIN-CAM SOFTAIL® 269

Chassis Trim – Brakes



E. FRONT BRAKE CALIPER KIT – RED
(41300152 SHOWN)



E. REAR BRAKE CALIPER KIT – RED
(41300157 SHOWN)

E. BRAKE CALIPER KIT – RED

Dress your bike in the latest high-performance look. Brilliant red calipers make a powerful visual statement and set your bike apart from the ordinary. Manufactured from Original Equipment components for proven performance, these calipers will add a stylish touch to the stock bike or add the perfect finish to a complete custom equipped with chrome or blacked-out wheels, rotors and fork sliders.

41300127 Front & Rear Kit. **\$399.95**

Fits '08-'17 Dyna® (except FXDF, FXDLS and '14-'17 FXDL) and '08-'14 Softail® models (except Springer™) equipped with single disc front brakes. Kit includes one front and one rear caliper. Brake pads sold separately.

41300152 Front – Single Disc. **\$249.95**

Fits '15-later Softail models (except FXDRS, FXFB, FXFBS, FXSE). Kit includes brake pads.

41300157 Rear. **\$299.95**

Fits '08-'17 Dyna and Softail models. Brake pads sold separately.

F. BRAKE CALIPER KIT – CHROME

Add the shine of chrome to your front end with this highly polished Chrome Front Brake Caliper Kit. Manufactured from Original Equipment components for proven performance, these calipers are a great addition to the stock front end or add the finishing touch to a complete custom with chrome wheels, rotors and chrome fork sliders.

41300148 Front – Single Disc. **\$399.95**

Fits '15-later Softail models (except FXDRS, FXFB, FXFBS, FXSE). Kit includes brake pads.

44395-08 Front – Single Disc. **\$389.95**

Fits '08-'17 Dyna (except FXDF, FXDLS and '14-'17 FXDL) and '08-'14 Softail models (except Springer) equipped with single disc front brakes. Brake pads sold separately.

44395-00A Front – Single Disc. **\$389.95**

Fits '00-'03 XL, '00-'07 Dyna and '00-'07 Softail models (except Springer) equipped with single disc front brakes. Brake pads sold separately.

42047-08 Rear. **\$349.95**

Fits '08-'17 Dyna and Softail models. Brake pads sold separately.

Shown with:

REAR CALIPER BRACKET – CHROME

Complete a chrome rear brake conversion. This Rear Caliper Bracket sets your ride apart from the others by replacing the painted black mount with brilliant chrome. Manufactured from the Original Equipment components for exact fit, this mount will bolt to the existing mounting location.

42048-08 Fits '08-'17 Softail models. **\$129.95**



F. FRONT BRAKE CALIPER KIT – CHROME
(41300148 SHOWN WITH CLASSIC CHROME CALIPER INSERT)



F. FRONT BRAKE CALIPER KIT – CHROME
(44395-08 SHOWN WITH CLASSIC CHROME CALIPER INSERT)



F. FRONT BRAKE CALIPER KIT – CHROME
(41300148 SHOWN)



F. FRONT BRAKE CALIPER KIT – CHROME
(44395-08 SHOWN)



F. REAR BRAKE CALIPER KIT – CHROME
(SHOWN WITH CHROME REAR CALIPER BRACKET)

SOFTAIL

Notice: The prices appearing in this catalog are the manufacturer's suggested retail prices. Actual retail prices may vary.

270 TWIN-CAM SOFTAIL®

Chassis Trim – Front End

A. BRAKE BLEEDER AND BANJO BOLT COVERS

1. Brake Bleeder Screw Cover

This cover adds chrome to the unfinished bleeder valve on all stock H-D® calipers. Package of two.

43834-98 \$23.95

Fits '84-later stock calipers (except XG and XR models).

2. Chrome Banjo Bolt Cover

Die-cast chrome cover provides a custom look to your stock banjo bolts. Fits banjo bolts on front and rear brake master cylinders and front and rear calipers. Installs in seconds.

32715-98 \$21.95

Fits '84-later models with stock master cylinders and calipers. (Does not fit VRSC™ Rear Master Cylinder, '06-'17 VRSC calipers, '15-later XG, '04-later XL, or '08-later Dyna®, Softail®, Touring and Trike models.)



A. BRAKE BLEEDER AND BANJO BOLT COVERS

B. FORK AXLE RETAINER NUT KIT – CHROME

It's the details that count. Complete the chrome transformation by adding this finishing touch to your chrome fork sliders. This Axle Retainer Nut Kit includes the stylish chrome-plated nuts and chrome lockwashers necessary to replace the stock hardware.

45813-03 \$8.95

Fits '91-'05 FXDWG, '86-'07 FLST, FLSTC, FLSTF and FLSTN, '91-'07 FXST and FXSTB, and '84-'13 Touring and Trike models.



B. FORK AXLE RETAINER NUT KIT – CHROME

C. FORK SLIDER DRAIN SCREW KIT – CHROME

C. FORK SLIDER DRAIN SCREW KIT – CHROME

It's the details that count. Complete the chrome transformation by adding this finishing touch to your chrome fork sliders. This Fork Slider Drain Screw Kit includes two chrome-plated drain screws and the seals required to replace the stock hardware.

45848-03 \$3.95

Fits '93-'05 FXDWG, '87-'17 Softail (except Springer™, FXCW, FXCWC, FXSB, FXSBSE, FXSE and FXSTD) and '87-'13 Touring and Trike models.



D. CUSTOM CALIPER BOLT COVER KIT

Cover your 12-point caliper bolts in chrome. These easy-to-install chrome covers are held firmly in place with a steel spring clip and are styled to match the Chrome Rocker Box Bolt and Headbolt Covers.

40955-05 Four Large and Two Small Covers. \$28.95

Fits '00-later front brake calipers (except Springer models, '06-later VRSC, '04-later XL, '15-later XG, '16-'17 FXDLS, '18-later Softail, '08-later Touring and Trike and models equipped with caliper covers). Also fits rear calipers on '06-'17 Softail models (except FXCW, FXSE).

40959-05 Three Large and Two Small Covers. \$23.95

Fits '00-later rear brake calipers (except Springer, '06-later VRSC, '04-later XL, '15-later XG, '16-'17 FXDLS, '18-later Softail, '08-later Touring and Trike and models equipped with caliper covers). Also fits rear calipers on '06-'17 Softail models (except FXCW, FXSE).

E. CALIPER HARDWARE KIT – CHROME

Chrome-plated hardware is a great finishing touch to chrome Brake Calipers. This kit replaces the Original Equipment black 12-point bolts on a single caliper.

44473-02A \$44.95

Fits '00-'07 models (except Springer front caliper, '06-'07 VRSC, '04-'07 XL, and '06-'07 FX Softail rear calipers).



F. BRAKE CALIPER INSERTS

Easy-to-install inserts add a finishing touch to the front and rear brake calipers. Select a style that follows your custom direction. Self-adhesive backing.

Fits '00-later front and rear brake calipers on all models (except Springer front, '06-later VRSC, '15-later XG, '04-later XL, '18-later Softail rear caliper, and '08-later Touring and Trike).

1. 44477-99 Classic Chrome. \$16.95

2. 44476-99 Harley-Davidson Script. \$16.95

E. CALIPER HARDWARE KIT – CHROME

F. BRAKE CALIPER INSERTS

Notice: The prices appearing in this catalog are the manufacturer's suggested retail prices. Actual retail prices may vary.

TWIN-CAM SOFTAIL® 271

Chassis Trim – Rear End



G. UPPER BELT GUARD – CHROME

G. UPPER BELT GUARD – CHROME

Hand-polished and chrome-plated to replace your factory-equipped painted upper belt guard.

60867-08 **\$109.95**

Fits '07-'17 FLS, FLSS, FLSTFB, FLSTFBS, FLSTSB, FLSTSC, FXCW, FXS, FXSB, FXSE, FXST and FXSTB models. Stock on many '07-'17 Softail® models.

H. SHOR'TEE UPPER BELT GUARD – GLOSS BLACK

Give your Softail motorcycle a unique stylish look. Designed as a direct replacement for the Original Equipment upper belt guard, this slotted steel guard adds a minimalistic "bobbed" look to the bike's profile. With its cut-down length and turned-up tail, this Upper Belt Guard is the ultimate extension of your bike's personality. Kit includes all required mounting hardware.

60300004 **\$109.95**

Fits '08-'17 Softail models.

I. LOWER BELT GUARD

This handsome formed steel guard replaces the Original Equipment plastic debris deflector, providing a rich smooth surface that complements the swingarm and frame. Available in chrome or gloss black finish, this complete kit includes all required mounting hardware.

Fits '07-'17 FLS, FLSS, FLSTC, FLSTN, FLSTNSE, FXS, FXSB, FXSBSE, FXSE and FXSTD models.

60654-07A Chrome. **\$94.95**

57100179 Gloss Black. **\$94.95**

Fits '07-'17 FLSTF, FLSTFB, FLSTFBS, FLSTSB, FXST, FXSTB and FXSTC, '14-'15 FLSTNSE, '10-'12 FLSTSE, '16-'17 FXSE and '07-'08 FXSTSSE. Chrome version stock on '14-'15 FLSTNSE, '10-'12 FLSTSE and '07-'08 FXSTSSE models.

60655-07A Chrome. **\$94.95**

Fits '00-'06 Softail models (except '06 FXST, FXSTB and FXSTS).

60316-00A Chrome with H-D Script Logo. **\$94.95**



H. SHOR'TEE UPPER BELT GUARD – GLOSS BLACK



I. LOWER BELT GUARD – CHROME
(60654-07A SHOWN)



I. LOWER BELT GUARD – GLOSS BLACK
(57100179 SHOWN)

Notice: The prices appearing in this catalog are the manufacturer's suggested retail prices. Actual retail prices may vary.

272 TWIN-CAM SOFTAIL®

Chassis Trim – Rear End

A. CONTOURED FRAME INSERTS

Add a custom filled and molded look to the Softail® frame. These Contoured Frame Inserts are shaped to fill the frame recesses that surround the swingarm pivot bolt. The smooth teardrop shape blends with the frame for maximum impact. These inserts complement both a black-painted or chrome-plated swingarm installation. Adhesive backed for easy installation.

48211-08 Chrome. **\$64.95**
Fits '08-'17 Softail® models (except FXCW, FXCWC, FXSB and FXSBSE).

48212-08 Chrome. **\$64.95**
Fits '08-'17 FXCW, FXCWC, FXSB and FXSBSE and '16-later FXSE models.

B. SOFTAIL® FRAME TRIM SET

These easy-to-install chrome-plated trim plates fit into the recesses at the rear of the Softail frame and add a bright finishing touch. To complete the look, add a set of chrome Swingarm Pivot Bolt Covers (sold separately).

47300-88T **\$27.95**
Fits '84-'17 Softail models (except '00-'17 FLSTF, FLSTFB, FLSTFBS, FLSTN, FLSTSB and FXSTD models equipped with shotgun exhaust).

C. SOFTAIL FRAME INSERT AND PIVOT BOLT KIT

Chrome rear frame inserts get you going on the road toward the perfect Softail. Kit includes Swingarm Pivot Bolt Covers and Frame Inserts. Easy installation kit.

48452-00 **\$40.95**
Fits '00-'07 FLSTF, FLSTN and FXSTD models. Does not fit FXSTDSE.



A. CONTOURED FRAME INSERTS



B. SOFTAIL FRAME TRIM SET



C. SOFTAIL FRAME INSERT AND PIVOT BOLT KIT

Notice: The prices appearing in this catalog are the manufacturer's suggested retail prices. Actual retail prices may vary.

TWIN-CAM SOFTAIL® 273

Chassis Trim – Rear End



D. SWINGARM PIVOT BOLT COVERS – CHROME



D. SWINGARM PIVOT BOLT COVERS – GLOSS BLACK



E. SWINGARM PIVOT BOLT COVERS – WILLIE G SKULL COLLECTION



F. SWINGARM PIVOT BOLT COVERS – HARLEY-DAVIDSON MOTOR CO. LOGO



G. SWINGARM PIVOT BOLT COVERS – BRASS COLLECTION



D. SWINGARM PIVOT BOLT COVERS

Cover your swingarm pivot bolt with distinctive styling. Available in your choice of mirror chrome or gloss black finish, this kit includes set screws and Allen® wrench for easy installation (sold in pairs).

Fits '08-'17 Softail® models (except FXCW, FXCWC, FXSB, FXSBSE, FXSE and FXST-Aus) and models equipped with Passenger Footboard Kits.

47660-09	Chrome – Die-cast.	\$31.95
47612-08	Chrome – Billet.	\$43.95
47649-09	Gloss Black – Billet.	\$43.95

Fits '00-'07 Softail models (except FLSTF, FXSTD and models with Passenger Footboard Kit).

43462-00	Chrome – Die-cast.	\$34.95
-----------------	--------------------	----------------

Fits '84-'99 Softail models (except FLSTS).

43897-86B	Chrome – Die-cast.	\$34.95
------------------	--------------------	----------------

E. SWINGARM PIVOT BOLT COVERS – WILLIE G SKULL COLLECTION

Add a little attitude to your ride. Styled to complement Harley-Davidson® Skull accessory items, the menacing raised skull with black-filled eyes leaps from a field of chrome. The surrounding Harley-Davidson Motorcycles script is the perfect finishing touch. This easy-to-install kit includes left and right pivot bolt covers and necessary mounting hardware.

47663-09		\$34.95
-----------------	--	----------------

Fits '08-'17 Softail models (except FXCW, FXCWC, FXSB, FXSBSE, FXSE and FXST-Aus).

43235-08		\$34.95
-----------------	--	----------------

Fits '00-'07 Softail models (except FLSTF, FXSTD and models with Passenger Footboard Kit).

F. SWINGARM PIVOT BOLT COVERS – HARLEY-DAVIDSON MOTOR CO. LOGO

Die-cast, chrome-plated with black Harley-Davidson Motor Co. logo. Includes set screws and Allen wrench for easy installation (sold in pairs).

47630-09		\$34.95
-----------------	--	----------------

Fits '08-'17 Softail models (except FXCW, FXCWC, FXSB, FXSBSE, FXSE and FXST-Aus).

G. SWINGARM PIVOT BOLT COVERS – BRASS COLLECTION

Styled to complement the complete Brass Collection, these easy to install components hide the swingarm pivot bolt is classic style. Manufactured from solid brass, these heritage-finished covers feature a natural antique finish that will age and patina when exposed to the elements. Kit includes mounting hardware.

61400346		\$54.95
-----------------	--	----------------

Fits '08-'17 Softail models (except FXCW, FXCWC, FXSB, FXSBSE, FXSE and FXST-Aus. and models equipped with Passenger Footboard Kits).

SOFTAIL

Notice: The prices appearing in this catalog are the manufacturer's suggested retail prices. Actual retail prices may vary.

274 TWIN-CAM SOFTAIL®

Chassis Trim – Rear End

REAR AXLE NUT COVERS

Cover your rear axle nut in the most traditional way. These Rear Axle Cover Kits complement the matching Front Axle Nut covers. Easy to install, these cover kits include necessary mounting hardware. Sold in pairs.

A. REAR AXLE NUT COVERS

Fits '08-'17 Dyna® and '08-later Softail® models (except FXCW, FXCWC, FXSB, FXSBSE, FXSE, FXST-Aus, and '18-later FLFB, FLFBS, FLSB, FXBR, FXBRS and FXDRS).

41705-09	Chrome – Die-cast.	\$29.95
43132-08	Chrome – Billet.	\$42.95
43422-09	Gloss Black – Billet.	\$42.95

Fits '00-'07 Softail models (except FLSTS and FLSTSC). (Will not fit with saddlebags.)

44256-01	Chrome – Die-cast.	\$29.95
-----------------	--------------------	----------------

Fits '09-'11 FXCW and FXCWC, '13-'17 FXSB and FXSBSE, and '16-'17 FXSE models.

43000051	Chrome – Billet.	\$109.95
43000052	Gloss Black – Billet.	\$109.95

B. REAR AXLE NUT COVERS – SATIN CHROME

Cover your rear axle nut in the most traditional way. Finished in rich satin chrome, these easy to install rear axle covers are a subtle addition to blacked-out finishes. Kit includes necessary mounting hardware. Sold in pairs.

43000110		\$29.95
-----------------	--	----------------

Fits '08-'17 Dyna and '08-later Softail models (except FXCW, FXCWC, FXSB, FXSBSE, FXST-Aus and '18-later FLFB, FLFBS, FLSB, FXBR, FXBRS and FXDRS).

C. REAR AXLE NUT COVERS – BRASS COLLECTION

Cover your rear axle nut in the most traditional way. Artistically manufactured from solid brass, these components feature a natural antique finish that will age and patina when exposed to the elements. Brass Collection Rear Axle Nut Covers complement the matching Front Axle Nut covers. Easy to install kits include all necessary mounting hardware. Sold in pairs.

43000050		\$54.95
-----------------	--	----------------

Fits '08-'17 Dyna and '08-later Softail models (except FXCW, FXCWC, FXSB, FXSBSE, FXST-Aus and '18-later FLFB, FLFBS, FLSB, FXBR, FXBRS and FXDRS).

D. REAR AXLE NUT COVERS – H-D MOTOR CO. LOGO

41704-09		\$31.95
-----------------	--	----------------

Fits '08-'17 Dyna and '08-later Softail models (except FXCW, FXCWC, FXSB, FXSBSE, FXSE, FXST-Aus, and '18-later FLFB, FLFBS, FLSB, FXBR, FXBRS and FXDRS).

E. REAR AXLE NUT COVERS – WILLIE G SKULL

41706-09A		\$34.95
------------------	--	----------------

Fits '08-'17 Dyna and '08-later Softail models (except FXCW, FXCWC, FXSB, FXSBSE, FXSE, FXST-Aus, and '18-later FLFB, FLFBS, FLSB, FXBR, FXBRS and FXDRS).

43221-08		\$34.95
-----------------	--	----------------

Fits '00-'07 later Softail models.



A. REAR AXLE NUT COVERS – CHROME (44256-01 SHOWN)



A. REAR AXLE NUT COVERS – GLOSS BLACK (43422-09 SHOWN)



A. REAR AXLE NUT COVERS – CHROME (43000051 SHOWN)



A. REAR AXLE NUT COVERS – GLOSS BLACK (43000052 SHOWN)



B. REAR AXLE NUT COVERS – SATIN CHROME



C. REAR AXLE NUT COVERS – BRASS COLLECTION



D. REAR AXLE NUT COVERS – H-D MOTOR CO. LOGO



E. REAR AXLE NUT COVERS – WILLIE G SKULL

Notice: The prices appearing in this catalog are the manufacturer's suggested retail prices. Actual retail prices may vary.



NEW

F. DOMINION REAR AXLE NUT COVERS – GLOSS BLACK



NEW

F. DOMINION REAR AXLE NUT COVERS – BRONZE

TWIN-CAM SOFTAIL® 275

Chassis Trim – Rear End

F. DOMINION™ COLLECTION REAR AXLE NUT COVERS

Express your bold, renegade attitude. The machined aluminum Dominion™ Collection Rear Axle Nut Covers add style to the front of the bike and are the perfect complement to other Dominion Collection accessories.

Fits '08-'17 Dyna® and '08-later Softail® models (except FXCW, FXCWC, FXSB, FXSBSE, FXST-AUS and '18-later FLFB, FLFBS, FXBR, FXBRS and FXDRS).

43000129	Gloss Black.	\$74.95
43000128	Bronze.	\$74.95

G. BAR & SHIELD REAR AXLE COVERS

Add a sweep of chrome to the rear of the swingarm. This mirror-finished cover hides the axle head and the rear of the swingarm (sold in pairs).

42069-08 **\$109.95**

Fits '08-'17 Softail models (except FLSTF, FLSTFB, FLSTFBS, FXCW, FXCWC, FXSB, FXSBSE and FXSE). Will not fit with saddlebags.

44345-09 **\$99.95**

Fits '08-'11 FXCW and FXCWC models. Will not fit with saddlebags.

H. REAR AXLE COVERS – CHROME

Traditional wedge-shaped rear axle covers follow the triangular lines of the Softail swingarm and conceal the swingarm tail for a clean, custom look. This kit includes left and right covers, complementing trim discs and all required mounting hardware.

47596-91B **\$99.95**

Fits '87-'07 Softail models (except FLSTS). Will not fit with saddlebags.

I. REAR AXLE ADJUSTER HARDWARE – CHROME

Highly polished and chrome-plated hex-head bolts replace the standard hardware for a custom look. Manufactured to Original Equipment specifications to ensure fit and performance, this kit is the perfect addition to a chrome or painted swingarm.

41202-08 Fits '08-'17 Softail models. **\$15.95**



G. BAR & SHIELD REAR AXLE COVERS (42069-08 SHOWN)



G. BAR & SHIELD REAR AXLE COVERS (44345-09 SHOWN)



H. REAR AXLE COVERS – CHROME



I. REAR AXLE ADJUSTER HARDWARE – CHROME

Notice: The prices appearing in this catalog are the manufacturer's suggested retail prices. Actual retail prices may vary.

276 TWIN-CAM SOFTAIL®

Chassis Trim

A. FRONT FUEL TANK MOUNTING HARDWARE KIT – CHROME

Beauty lies in the details. And this chrome-plated Fuel Tank Mounting Hardware Kit ensures you won't leave this one overlooked. The perfect finishing touch to your fuel tank, the kit includes the machined washers and custom nuts required for your model.

62965-01 **\$29.95**
Fits '00-'17 Softail® models (except FLSTSE, FLSTNSE and FXSBSE).

B. BAR & SHIELD LOGO COIL COVER

Featuring a radical open-face design with a Bar & Shield logo silhouette, this chrome coil cover matches chrome Voltage Regulator Covers P/N 74597-01, for an integrated custom look. Includes all mounting hardware.

74616-04 **\$39.95**
Fits '04-'17 EFI Dyna® and '01-'17 EFI equipped Softail models (except FXCW, FXCWC, FXS, FXSB, FXSBSE, FXSE, and FXST-Aus).

C. VOLTAGE REGULATOR – CHROME

Original Equipment voltage regulators with a sparkling triple-plated chrome finish. Hand-buffed, then copper-, nickel- and chrome-plated, these brilliant chrome-plated regulators are the perfect highlight for any Harley-Davidson® motorcycle.

74567-11 Fits '11-'17 Softail models. **\$169.95**
74610-08 Fits '08-'10 Softail models. **\$169.95**

D. VOLTAGE REGULATOR COVER – CHROME

With a look that creates its own electricity, this chrome-plated cover features an embossed Bar & Shield logo and an open-center grill that allows air to flow right through for regulator cooling. Designed for easy installation. Chrome mounting hardware included.

74597-01 **\$44.95**
Fits '01-'17 Softail models (except FXSE). Will fit models equipped with Bullet Front Spoiler P/N 57039-XX. Will not fit with other Softail front spoilers.

PREMIUM OIL COOLER KITS

This oil cooler was designed specifically for Harley-Davidson to out-perform all other coolers in the industry. The cooler features a unique Turbulator system that evenly distributes oil across the cooling chambers. The air fins are designed to efficiently dissipate heat. The oil cooler has been designed to simplify installation and enhance performance. The large heat exchanger provides excellent cooling efficiency. The kit features a one-piece adapter plate with integrated thermostat that allows oil lines to connect to the oil filter bracket. Thermostat activates at 185°F (85°C). Kit comes complete with mounting hardware and precut oil lines.

E. PREMIUM OIL COOLER KIT – SOFTAIL® MODELS

26157-07A Center Mount. **\$379.95**
Fits '13-'17 FXSBSE and '00-'17 Softail models (except FXSB) without ABS. Does not fit '11 FXCWC. '08-'10 FXCW and FXCWC models require separate purchase of Horn Relocation Kit for Oil Cooler P/N 69015-08. Does not fit with Softail Front Spoiler Kits, or DEFINITIVE5 Filtration System Kits. Fits with all H-D® Engine Guards. Includes Chrome Oil Cooler Cover.

26157-11A Side Mount. **\$379.95**
Fits '11-'17 Softail models. Fits with all H-D Engine Guards. Kit includes Gloss Black Oil Cooler Cover.

Also available:

HORN RELOCATION KIT

Required when installing Oil Cooler Kit P/N 26157-07 on FXCW and FXCWC models.

69015-08 **\$12.95**
Fits '08-'10 FXCW and FXCWC models equipped with Oil Cooler Kit P/N 26157-07.



A. FRONT FUEL TANK MOUNTING HARDWARE KIT – CHROME



B. BAR & SHIELD LOGO COIL COVER



C. VOLTAGE REGULATOR – CHROME



D. VOLTAGE REGULATOR COVER – CHROME



E. PREMIUM OIL COOLER KIT – '00-LATER SOFTAIL WITHOUT ABS CENTER MOUNT



E. PREMIUM OIL COOLER KIT – '11-LATER SOFTAIL WITH ABS SIDE MOUNT

Notice: The prices appearing in this catalog are the manufacturer's suggested retail prices. Actual retail prices may vary.

TWIN-CAM SOFTAIL® 277

Chassis Trim – Fenders



F. FRONT FENDER RAIL AND STANCHION KIT



G. FRONT FENDER TRIM

F. FRONT FENDER RAIL AND STANCHION KIT*

Chrome-plated accents straight from our 1947 catalog. Includes template for easy installation.

91117-97 \$69.95

Fits '84-'17 FL Softail® (except FLS, FLSS, FLSTF, FLSTFB, FLSTFBS, FLFTNSE, FLSTSB and FLTSE), '18-later Softail FLDE, FLHC and FLHCS, '84-later Touring (except FLHRXS), and Trike models.

G. FRONT FENDER TRIM

Add a sweeping dash of chrome to the front fender. Chrome-plated tapered spear features a stepped design that accentuates the flowing fender lines. Self-adhesive backing simplifies installation.

14100618 \$44.95

Fits '12-'16 FLD, '86-'17 FL Softail (except FLSTSB), '18-later Softail FLDE, FLHC and FLHCS, '84-later Touring and Trike models.

H. BAR & SHIELD LOGO FRONT FENDER SPEAR

This chrome-plated trim spear adds a sweeping dash of chrome to the front fender. Featuring a raised Bar & Shield logo set against a textured black field, this self-adhesive medallion is easy to install.

91195-04 Large \$44.95

Fits '12-'16 FLD, '86-'17 FL Softail (except FLSTSB), '18-later Softail FLDE, FLHC and FLHCS, '84-later Touring and Trike models.

91194-04 Small \$39.95

Fits XL, XR, Dyna® (except FLD), FX Softail (except FXFB) and '18-later FLSTL models.



H. BAR & SHIELD LOGO FRONT FENDER SPEAR (LARGE SHOWN)



H. BAR & SHIELD LOGO FRONT FENDER SPEAR (SMALL SHOWN)

I. CONCHO FENDER SKIRT

This decorative fender skirt features conchos inspired by the Heritage Softail Classic model.

59147-96 \$59.95

Fits '06 FLST, '86-'08 FLSTC, '93-'96 FLSTN, '80-'13 Touring and '09-'13 Trike models equipped with Original Equipment fender skirt.

J. WILLIE G SKULL FENDER SKIRT

This decorative chrome-plated fender skirt is a direct replacement for stock fender skirt. Features a three-dimensional sculptured concho with skull design set off with black accents. Mounting hardware included.

59582-02A \$59.95

Fits '06 FLST, '86-'08 FLSTC, '93-'96 FLSTN, '80-'13 Touring and '09-'13 Trike models equipped with Original Equipment fender skirt.

K. BAR & SHIELD FENDER SKIRT

This rigid-steel fender skirt, designed to replace the original factory-equipped aluminum trim, is formed, polished and chrome-plated. Its ribbed pattern offers a unique styling element and adds rigidity. Subtle but distinctive brushed aluminum Bar & Shield logos are framed by a stamped-in ribbed outline on both sides.

59228-91 \$59.95

Fits '06 FLST, '86-'08 FLSTC, '93-'96 FLSTN, '80-'13 Touring and '09-'13 Trike models equipped with Original Equipment fender skirt.

L. FRONT FENDER EXTENSION – CHROME

Dress your front fender in chrome. This chrome-plated tapered Fender Extension is shaped to follow the curve of the fender for style and function. Using the Original Equipment fender hole, the extension mounts below the trailing edge of the fender to help control road dirt and spray.

59664-03 \$49.95

Fits '91-'08 Dyna and '84-'07 FX Softail models. (Will not fit FXD, FXDX or FXDXT models equipped with Voltage Regulator Covers.)



I. CONCHO FENDER SKIRT



J. WILLIE G SKULL FENDER SKIRT



K. BAR & SHIELD FENDER SKIRT



L. FRONT FENDER EXTENSION – CHROME



***WARNING:** Fender rails are decorative items only. Do not strap anything to the rails. Adding additional weight to the front fender could adversely affect vehicle handling, causing loss of control and death or serious injury.

Notice: The prices appearing in this catalog are the manufacturer's suggested retail prices. Actual retail prices may vary.

SOFTAIL

278 TWIN-CAM SOFTAIL®

Chassis Trim – Fenders

A. FRONT FENDER TRIM KIT – CHROME

Replace the Original Equipment stainless steel fender trim with a splash of chrome. Kit includes left and right side trim strip.

59209-91T **\$29.95**

Fits '86-'17 FLSTC and FLSTN and '82-'13 Touring models (except Road Glide® and Road King® Custom). Does not fit models equipped with clean front fender.



A. FRONT FENDER TRIM KIT – CHROME

B. FENDER TIP LENS KIT WITH SKULL LOGO

This chrome-plated fender tip lens kit adds a little attitude to your ride. The kit features front and rear lenses with a translucent illuminated skull silhouette. The easy-to-install kit includes an amber front lens and red rear lens.

59651-01 **\$29.95**

Fits '86-'17 FLSTC, '93-'96 FLSTN and '80-'08 Electra Glide®, Tour Glide and Road King® models (except FLHRC and FLHRS).



A. FRONT FENDER TRIM KIT – CHROME

C. BAR & SHIELD LOGO FENDER TIP LENS KIT

Chrome-plated polycarbonate construction features translucent Bar & Shield emblems. The kit includes front and rear lenses. Front lens features an amber Bar & Shield logo, rear lens features a red Bar & Shield logo. Quick and easy installation.

59081-96 Front and Rear. **\$29.95**

Fits '86-'17 FLSTC, '93-'96 FLSTN and '80-'08 FLHR, FLHS, FLHT and FLT models. (Does not fit Springer™, FLHRS or FLTR.)

D. H-D® CLASSIC FENDER TIP

Stock on Road King Classic models, these nostalgic-look fender tips are also available for other models. Replaces fender lamp assembly.

59002-98 Front. **\$31.95**

Fits '80-'13 FL, '86-'08 FLSTC, '94-'13 FLHR and '09-'13 FLHTCUTG models.

59052-98 Rear. **\$31.95**

Fits '80-'08 FL and FLHR models and '86-'99 FLSTC models. (Does not fit FLSTF and FLTR models.)

E. EAGLE WING FENDER TRIM FOR FAT BOY® MODELS

Classic Eagle Wing logo in gold & chrome with black accent. Matches Eagle Wing headlamp, tail lamp and turn signal visors.

Fits '90-'06 FLSTF models.

1. 59369-97 Rear, Gold & Chrome. **\$35.95**

Fits '90-'17 FLSTF, FLSTFB and FLSTFBS models.

2. 59367-97 Front, Gold & Chrome. **\$35.95**



B. FENDER TIP LENS KIT WITH SKULL LOGO



C. BAR & SHIELD LOGO FENDER TIP LENS KIT



D. H-D CLASSIC FENDER TIP



E. EAGLE WING FENDER TRIM FOR FAT BOY MODELS

Notice: The prices appearing in this catalog are the manufacturer's suggested retail prices. Actual retail prices may vary.

TWIN-CAM SOFTAIL® 279

Chassis Trim – Fenders



F. HERITAGE FRONT FENDER RAIL – CHROME



F. HERITAGE FRONT FENDER RAIL – CHROME*

A stylish re-creation of a popular Hydra Glide model accessory direct from the Harley-Davidson® 1959 accessories catalog. Ornate, jet, twin-tube design sweeps smartly back along the front fender. Sparkling chrome-plating and years-ahead styling make it a hit for all Heritage and FLSTN owners.

91080-93 **\$99.95**

Fits '87-'17 FLST, FLSTC and '93-'96 FLSTN models. (Does not fit Springer™ models.)

G. HERITAGE REAR FENDER RAIL – CHROME*

A perfect match to Heritage Chrome Front Fender Rail P/N 91080-93. Designed to fit with stock FLSTC, FLSTN saddlebags or Genuine Harley-Davidson® Fat Boy® leather saddlebags.

91402-00 **\$99.95**

Fits '00-'17 FLST and FLSTC models.

H. HERITAGE SOFTAIL® CLASSIC REAR FENDER LEATHER MUD FLAP

Get nostalgic with top-grain cowhide decorated with bright spots and a Heritage-style concho. A perfect match with your Heritage saddlebags. Kit includes installation hardware and template.

59071-98 Fits '86-'17 FLSTC models. **\$59.95**

I. HERITAGE SPRINGER™ LEATHER MUD FLAP WITH FRINGE

Made from premium, plated leather with black trim, these flaps have fringe and an '97-'03 FLSTS concho and black trim. Includes chrome hardware, support bracket and fender mounting template.

59027-99 **\$59.95**

Fits '97-'03 FLSTS models front or rear fender. Also fits '86-'17 FLSTC, '86-'06 FLSTF and '93-'96 FLSTN models.



G. HERITAGE REAR FENDER RAIL – CHROME



H. HERITAGE SOFTAIL CLASSIC REAR FENDER LEATHER MUD FLAP



I. HERITAGE SPRINGER LEATHER MUD FLAP WITH FRINGE



***WARNING:** Fender rails are decorative items only. Do not strap anything to the rails. Adding additional weight to the front fender could adversely affect vehicle handling, causing loss of control and death or serious injury.

Notice: The prices appearing in this catalog are the manufacturer's suggested retail prices. Actual retail prices may vary.



*Handlebar height is regulated in many locations. Check local laws before installation.

ROAD GLIDE[®] SPECIAL

TOURING | FLTRXS | WICKED RED DENIM

It's not how good you look. It's how good you look going fast. And with a 21" front wheel, 117 cubic inches of Stage IV power and blacked-out trim, you'll be the best-looking blur anyone has only sort of seen.



Screamin' Eagle[®] High Flow Exhaust..... p.458



Kahuna[™] Footboard/Shifter Peg (Chrome) p.585



Screamin' Eagle[®] Timer Cover Base & Stage IV 117 Insert...p.465



Knockout[™] 21" Custom Wheel Kit (Contrast Chrome)p.756



*Handlebar height is regulated in many locations. Check local laws before installation.

ROAD KING®

TOURING | FLHR | KINETIC GREEN

Chromed out and ready to shine, the Road King® motorcycle is the attention-grabbing cruiser you have to see to believe. 16" laced wheel. Fat ape handlebars. 7" projector headlamp. When you're on this Road King® there's no hiding your personality or our heritage.



Airflow Hand Grips (Chrome)..... p.598



Low Profile Touring Seat p.337



Lower Fork Sliders (Chrome)..... p.389



7" Daymaker® Projector LED Headlamp..... p.714



*Handlebar height is regulated in many locations. Check local laws before installation.

ROAD KING® SPECIAL

TOURING | FLHRXS | TWISTED CHERRY

England has their queen, and we have our king. With a richness you can see and feel, this Road King® Special motorcycle continues to rule with its blacked-out engine, 12" apes, high-flow exhaust and 117 cubic inches of Stage IV power. We may not have a royal family, but we definitely have a king.



12" Fat Ape Handlebars p 640



7" Daymaker® Adaptive LED Headlamp..... p 714



Defiance Hand Grips/Dominion® Mirrors (Black)..... p 588 & 619



Screamin' Eagle® High-Flow Exhaust p 458



STREET GLIDE®

TOURING | FLHX | BLUE MAX

You wanted the best. You got our best. This Street Glide® motorcycle is one of the most iconic bikes on the road today. And with chrome everything, color-matched accents and a bright-as-the-sun projector headlamp, it's a lot of rock and whole lot of roll.



7" Daymaker® Projector LED Headlamp (Chrome) p714



Defiance Passenger Footpegs (Chrome) p590



Chopped Smooth Tour-Pak® Backrest Pad p590



Screamin' Eagle® Timer Cover Base & Stage II 107 Insert p465



STREET GLIDE® SPECIAL

TOURING | FLHXS | COLOR SHOP LIMITED SERIES: GRANDSTAND

Why just ride when you can lay waste to asphalt everywhere? With exhilarating amounts of off-idle power from its Stage IV kit, free-flowing exhaust and Color Shop Limited Series paint, you'll dominate every street, road and boulevard from one end of the country to the other.



4.5" Windsplitter Windshield (Dark Smoke)..... p 308



Defiance Collection End Caps — 4.5" Black Machine Cut...p 457



Color Shop Limited Series: Grandstand p 784



Dominion™ Derby Cover (Black) p 528



ROAD GLIDE®

TOURING | FLTRX | KINETIC GREEN

Like a supermodel with a Ph.D., this Road Glide® motorcycle is the smart and sexy bike of your dreams. With its machine-cut accents, gloss black chopped engine guard and low-profile windscreen, it's more than just a motorcycle — it's the total package.



Road Glide® 4" Low-Profile Windscreen (Black)..... p315



Chopped Engine Guard (Gloss Black)..... p385



Screamin' Eagle® Timer Cover Base & Stage IV 114 Insert ...p 465



Defiance Upper Rocker Box Covers (Machine Cut)..... p534



*Handlebar height is regulated in many locations. Check local laws before installation.

ROAD GLIDE® ULTRA

TOURING | FLTRU | SILVER FLUX & BLACK FUSE

Play time is over, kids. Because this is no game — this is the Road Glide® Ultra model. With a powerful Boom!™ Audio Stage II speaker system, fairing speakers, fairing lower speakers, saddlebag speakers, Tour-Pak® speakers and 4 amplifiers, this is one bike that's all grown up and ready to rock and roll with the big boys.



Fairing Pouch p319



Airflow Footboard & Brake Pedal Pad (Chrome)p598



Tallboy® Seat With Rider Backrest p328



Boom!™ Audio Stage II Speakers — Tour-Pak® p669



ELECTRA GLIDE® ULTRA CLASSIC®

TOURING | FLHTCU | WICKED RED & BARRACUDA SILVER

Take on every mile in America. All four million of them. With everything you could ever want in a touring bike, plus a Tallboy® seat and handlebar, heated grips and illuminated accent trim, you'll quickly learn that this Electra Glide® Ultra Classic® model is more than just a motorcycle — it's a round-trip ticket to everywhere.



Tallboy® Seat p328



Kahuna™ Heated Hand Grips (Chrome)..... p606

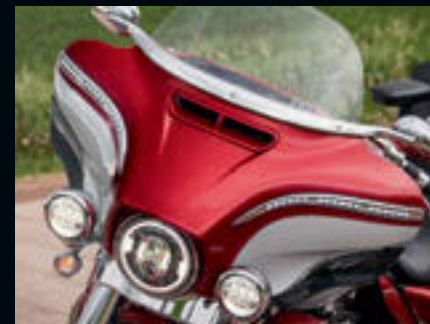

Electra Glo™ Illuminated Fairing Accent Trim..... p712



Kahuna™ Rider Footboards (Chrome) p585



ULTRA LIMITED

TOURING | FLHTK | INDUSTRIAL GRAY DENIM & BLACK DENIM

Park your favorite seat in front of more places than just your TV. With an ultra-comfortable heated saddle, blacked-out accents, CoolFlow™ fan and adjustable rider backrest, this Ultra Limited is all the entertainment you'll ever need with none of the commercial breaks.



Harley® Hammock Heated Rider & Passenger Touring Seat p333



CoolFlow™ Fan p322



Kahuna™ Heated Hand Grips (Black) p606



Kahuna™ Passenger Footboard Kit (Black)..... p584



ULTRA LIMITED LOW

TOURING | FLHTKL | WICKED RED & TWISTED CHERRY

Experience all the highs with a single low. With a plush and comfortable rider and passenger touring seat, rider backrest, and passenger armrests, it's easy to see why riding this Ultra Limited Low will always be the high point of your day.



Chrome Windshield Trim — Grooved..... p312



Harley® Hammock Rider & Passenger Touring Seat ... p333



Tour-Pak® Lid Organizer p369



Defiance Air Cleaner Trim (Chrome) p535



FREEWHEELER®

TOURING | FLRT | SCORCHED ORANGE & BLACK DENIM

Authenticity is as easy as one, two, three. With blacked-out everything, unique engine and transmission accents, Hollywood bars, and quick-release sissy bar, this is one trike that proves everything truly is better when it comes in threes.



Hollywood Handlebars p.635



Quick-Release Sissy Bar Upright (Gloss Black) p.344



Defiance Derby Cover (Black Machine Cut) p.534



Airflow Rider Footboard Kit (Gloss Black) p.599



TRI GLIDE® ULTRA CLASSIC®

TOURING | FLHTCUTG | SILVER FLUX & BLACK FUSE

Two wheels are good. Three wheels are classic. With an adjustable seat, 5-spoke wheels with a mirror chrome finish, Boom!™ Audio Stage II speaker system with fairing speakers and illuminated fairing trim, this Tri Glide® Ultra Classic® model is proof there's no such thing as too much of a good thing.



Road Zeppelin® Air Adjustable Seat..... p334



Kahuna™ Derby Cover (Chrome)..... p537



Batwing Fairing 10" Windshield (Light Smoke) p309



Enforcer Custom Wheels..... p758

DEFY THE WIND

At highway speed, you take the wind full-force in the chest, causing fatigue in your arms, neck and shoulders. Take the pressure off with an easy-to-install detachable windshield. Shaped to divert air, rain and road debris around the rider, a windshield can add hours of riding comfort.

EXTENDED COVERAGE

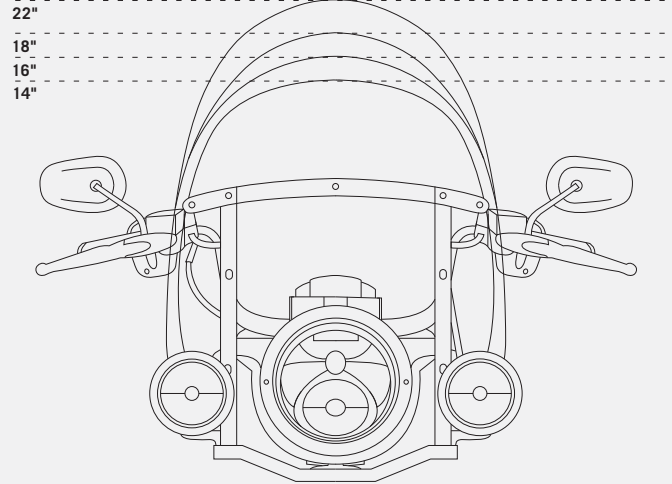
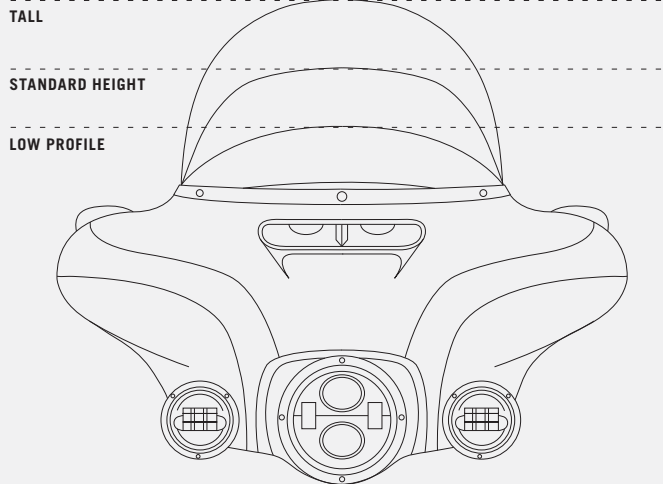

WIND SPLITTER

Wind Splitter windshields are shaped for effective airflow management and wow styling. The sweeping design adds height over a traditional low-profile wind deflector in the center where it counts.

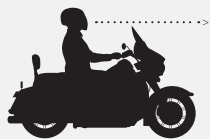

To avoid looking through bug spots, condensation and road grime, select a windshield that tops out just below your line of sight.



TOURING & TRIKE 305

Windshields — Road King®

A. H-D® DETACHABLES™ WINDSHIELDS – ROAD KING® MODELS

Designed to be installed or removed without tools in seconds, a detachable windshield gives you the freedom to define your ride at the drop of a hat. Ride across the country protected from the elements, then quickly remove the windshield to hit the streets in style. These one-piece windshields are formed from hard-coated polycarbonate material to resist scratching and the complete assembly features polished stainless steel brackets that mount to the Original Equipment rubber isolated docking points for ease of installation and removal. Windshields are available in a variety of heights to match your size and riding style.

Fits '94-later Road King® models. '04-'07 FLHRS and '17-later FLHRXS models require additional purchase of Mounting Hardware Kit P/N 58221-04.

57995-96 22" Clear – Polished. **\$349.95**
Windshield dimensions: Overall height – 29.0"; width – 23.1".

58325-06 18" Clear – Polished. **\$329.95**
Windshield dimensions: Overall height – 25.0"; width – 23.1".

57981-97 16" Light Smoke – Polished. **\$344.95**
Windshield dimensions: Overall height – 23.0"; width – 23.1".

57400380 20" Clear – Black. **\$359.95**
Windshield dimensions: Overall height – 27.2"; width – 23.1".

57400381 18" Clear – Black. **\$349.95**
Windshield dimensions: Overall height – 25.0"; width – 23.1".

57400383 16" Light Smoke – Black. **\$364.95**
Windshield dimensions: Overall height – 23.0"; width – 23.1".

Also available:

ROAD KING WINDSHIELD DOCKING HARDWARE KIT

Kit includes the hardware required to install a H-D® Detachables™ Road King Windshield on the Road King Custom and Special models.

58221-04 Fits '04-later FLHRS and '17-later FLHRXS models. **\$29.95**

Also available:

REPLACEMENT WINDSHIELD SCREEN

Formed of polycarbonate and available in a size that suits your riding needs. Kit includes screen, cross brace tape and instructions.

Fits '94-later Road King models (except '13-'14 FLHRSE).

58433-96 22" Clear. **\$154.95**

58135-94 20" Light Smoke. **\$169.95**

58195-94 16" Light Smoke. **\$149.95**



A. H-D DETACHABLES WINDSHIELD – POLISHED BRACES



A. H-D DETACHABLES WINDSHIELD – BLACK BRACES

TOURING

Notice: The prices appearing in this catalog are the manufacturer's suggested retail prices. Actual retail prices may vary.

306 TOURING & TRIKE

Windshields — Road King®

A. WIND SPLITTER VENTED WINDSHIELD

Reduce helmet buffeting at speed. The Harley-Davidson® Detachables™ Wind Splitter Vented Windshield features an exclusive fingertip-adjustable center vent that reduces turbulence behind the windscreen. When open, the controlled airflow fills the negative pressure area behind the shield and helps to smooth the flow of air over the top of the screen and around the rider. The revised flow reduces helmet bobbing and neck fatigue so you can comfortably spend more time in the saddle. The open vent also provides cooling airflow to the rider at low speeds and in city traffic.

Engineered to provide the riding comfort of a larger windshield, this low-profile screen's contemporary contour sets it apart from the crowd. The shape keeps the windshield below your site line so you don't look through bugs and road grime and the detachable design means you can ride without the shield when the mood strikes. The shield is formed of hard-coated polycarbonate for strength and scratch resistance and the dark-smoked finish reduces glare. The slim polished stainless steel brackets mount to the Original Equipment rubber isolated docking points for ease of installation and removal.

57400176 **\$429.95**

Fits '94-later Road King® models (except FLHRS). '17-later FLHRXS models require additional purchase of Mounting Hardware Kit P/N 58221-04. Does not fit with Mini Tach or Boom!™ Audio Cruiser Speakers Stock on '13-'14 FLHRSE. Windshield dimensions: Overall height – 22.4" height from headlamp opening – 16.1", width – 20.3".

B. ROAD KING® 14" H-D® DETACHABLES™ WIND DEFLECTOR

Maintain the same low-down mini-shield styling of the Road King® Dark Smoke Wind Deflector with a little extra wind protection. This 3.0" taller oversized dark smoke screen features polished stainless steel mounting brackets to provide the same ease of installation as the stock Road King windshield.

57357-07 14" Dark Smoke. **\$329.95**

Fits '94-later Road King models. '04-'07 FLHRS and '17-later FLHRXS models require additional purchase of Mounting Hardware Kit P/N 58221-04. Stock on '07 FLHRSE models. Windshield dimensions: Overall height – 21.0"; width – 21.4".

Also available:

ROAD KING 11" H-D DETACHABLES WIND DEFLECTOR

Keep the wind and glare out of your eyes with this Smoked Wind Deflector. This dark smoke detachable mini-shield follows the form of a traditional Harley-Davidson® Road King® windshield, but its much smaller size adds a touch of low-down attitude.

58163-02 11" Dark Smoke. **\$314.95**

Fits '94-later Road King models. '04-'07 FLHRS and '17-later FLHRXS models require additional purchase of Mounting Hardware Kit P/N 58221-04. Stock on '08 FLHRSE models. Windshield dimensions: Overall height – 18.0"; width – 19.4".



A. WIND SPLITTER VENTED WINDSHIELD



B. ROAD KING 14" H-D DETACHABLES WIND DEFLECTOR

Notice: The prices appearing in this catalog are the manufacturer's suggested retail prices. Actual retail prices may vary.

TOURING & TRIKE 307

Windshields — Freewheeler®

C. H-D® DETACHABLES™ WINDSHIELDS – FREEWHEELER® MODELS

Designed to be installed or removed without tools in seconds, a detachable windshield gives you the freedom to define your ride at the drop of a hat. Ride across the country protected from the elements, then quickly remove the windshield to hit the streets in style. These one-piece windshields are formed from hard-coated polycarbonate material to resist scratching and the complete assembly features polished stainless steel brackets that mount to rubber isolated docking points for ease of installation and removal. Windshields are available in a variety of heights to match your size and riding style.

Fits '15-later FLRT models.

57400273A 20" Clear. **\$354.95**

Windshield dimensions: Overall height – 25.5"; width – 22.2".

57400274 16" Light Smoke. **\$359.95**

Windshield dimensions: Overall height – 21.5"; width – 21.4".

D. FORK-MOUNT WIND DEFLECTORS – CHROME

Dress your bike for comfort and style. Wind Deflectors extend the windshield's coverage for superior protection in any weather. The scooped Deflectors are shaped to channel the air flow and direct the rush of air and turbulence around the rider. Deflectors attach to the fork brackets for a clean, integrated look and the chrome finish is the perfect complement to polished or chrome front end components. Easy-to-install kit includes all required mounting hardware.

57400146A **\$104.95**

Fits '95-later FLHR, FLHRC and FLHRS and '14-later FLHRSE models. Does not fit FLHT, FLHTC, FLHX and FLHXS or models equipped with Fairing Lower. Does not fit '95-'13 models equipped with Lighted Fork Slider Kit or Custom Auxiliary Lighting Bracket Kit P/N 69227-04A or 68000043.



C. H-D DETACHABLES WINDSHIELD – FREEWHEELER MODELS



D. FORK-MOUNT WIND DEFLECTORS – CHROME

Notice: The prices appearing in this catalog are the manufacturer's suggested retail prices. Actual retail prices may vary.

308 TOURING & TRIKE

Windshields — Electra Glide®

A. WIND SPLITTER WINDSHIELD – BATWING FAIRING

In the world of functional performance, size does matter. After all, it's simple to understand that the larger the windshield area, the greater the amount of wind deflection. The Wind Splitter Windshield is a great look for all Touring models and is shaped for the perfect combination of effective airflow management and "wow" styling. The sweeping design complements the shape of the fairing and the inner dash panel and adds height over a traditional low-profile wind deflector in the center where it counts. The shape decreases wind noise and improves your ability to hear the motorcycle's sound system. The rich smoked finish does not interfere with your forward view and looks great against any paint color. The easy-to-install Wind Splitter features a center-mount Bar & Shield medallion for a distinctive finishing touch.

Fits '14-later Electra Glide®, Street Glide®, Ultra Limited and Tri Glide® models.

57400204 4.5" Dark Smoke. **\$159.95**

Does not fit with Windshield Bags or Pouches.

57400205 7" Dark Smoke. **\$169.95**

Does not fit with Windshield Bags or Pouches.

57400206 10" Light Smoke. **\$169.95**

Fits '96-'13 Electra Glide, Street Glide and Trike models. Does not fit with fairing mounted zūmo® GPS Navigator, Windshield Bags or Pouches.

57400091 4.5" Dark Smoke. **\$159.95**

57164-10 7" Dark Smoke. **\$169.95**

57400092 10" Light Smoke. **\$169.95**



4.5" DARK SMOKE



7" DARK SMOKE



10" LIGHT SMOKE



A. WIND SPLITTER WINDSHIELD – BATWING FAIRING
(4.5" DARK SMOKE SHOWN)



A. WIND SPLITTER WINDSHIELD – BATWING FAIRING
(7" DARK SMOKE SHOWN)



A. WIND SPLITTER WINDSHIELD – BATWING FAIRING
(10" LIGHT SMOKE SHOWN)

Notice: The prices appearing in this catalog are the manufacturer's suggested retail prices. Actual retail prices may vary.

TOURING & TRIKE 309

Windshields — Electra Glide®

B. BATWING FAIRING WINDSHIELDS

Tailor your bike to your size and riding style. For the best compromise between adequate protection from the elements and a clear view of the road ahead, select a windshield that tops out just below eye level. This reduces helmet buffeting while allowing a view unobstructed by dirt, bugs and rain drops. Harley-Davidson® windshields are formed of hard-coated polycarbonate for strength and scratch resistance and are available in a variety of heights and tints to suit your riding needs.

Fits '14-later Electra Glide®, Street Glide®, Ultra Limited and Tri Glide® models.

57400224	15" Clear.	\$134.95
57400228	12" Clear.	\$134.95
57400226	12" Light Smoke.	\$134.95
57400227	10" Clear.	\$134.95
57400225	10" Light Smoke.	\$134.95

Fits '96-'13 Electra Glide, Street Glide and Trike models.

58314-97	15" Clear.	\$139.95
58187-96	12" Clear.	\$139.95
58302-96	12" Light Smoke.	\$139.95
58301-96	10" Clear.	\$139.95
58303-96	10" Light Smoke.	\$139.95

Fits '86-'95 FLHT models. (not shown)

58187-86	12" Clear.	\$149.95
-----------------	------------	-----------------



B. BATWING FAIRING WINDSHIELD – 15"



B. BATWING FAIRING WINDSHIELD – 12"



B. BATWING FAIRING WINDSHIELD – 10"

TOURING

Notice: The prices appearing in this catalog are the manufacturer's suggested retail prices. Actual retail prices may vary.

310 TOURING & TRIKE

Windshields — Electra Glide®

A. BATWING FAIRING WIND DEFLECTOR – MEDIUM PROFILE

Style meets function. This 7.0" tall Wind Deflector splits the difference between the wind deflector and a low windshield, offering sport styling with a little greater wind protection. Harley-Davidson® windshields are formed of hard-coated polycarbonate for strength and scratch resistance and the dark smoke tint complements any paint color.

57400229 7" Dark Smoke. **\$134.95**
Fits '14-later Electra Glide®, Street Glide®, Ultra Limited and Tri Glide® models.

57185-05 7" Dark Smoke. **\$129.95**
Fits '96-'13 Electra Glide, Street Glide and Trike models.
Stock on the '05 FLHTCSE models.

B. BATWING FAIRING WIND DEFLECTOR – LOW PROFILE

Maintain your forward view with this low-profile wind deflector. The shield adds a radical shape to the traditional Batwing fairing and the dark smoke tint complements any paint color. Harley-Davidson windshields are formed of hard-coated polycarbonate for strength and scratch resistance.

57400243 5" Dark Smoke. **\$134.95**
Fits '14-later Electra Glide, Street Glide, Ultra Limited and Tri Glide models. Stock on '14 FLHX models.

58207-04 4" Dark Smoke. **\$129.95**
Fits '96-'13 Electra Glide, Street Glide and Trike models.
Stock on '04 FLHTCSE models.

C. BATWING FAIRING 4" BLACK WIND DEFLECTOR

Opaque black 4.0" tall deflector provides radical styling for the ultimate custom cruiser.

58204-98 **\$129.95**
Fits '96-'13 Electra Glide, Street Glide and Trike models.



A. BATWING FAIRING WIND DEFLECTOR – MEDIUM PROFILE



B. BATWING FAIRING WIND DEFLECTOR – LOW PROFILE



C. BATWING FAIRING 4" BLACK WIND DEFLECTOR

Notice: The prices appearing in this catalog are the manufacturer's suggested retail prices. Actual retail prices may vary.



D. ADJUSTABLE AIR DEFLECTORS

D. ADJUSTABLE AIR DEFLECTORS

The Adjustable Air Deflectors feature an infinitely adjustable friction pivot that holds the wing in position to direct the air where you need it. Close the vent to direct airflow around the fairing or open the vent to maximize airflow on hot days. Available in dark or light smoke finish, the translucent deflectors are easy to install with the included mounting hardware.

57000529 Dark Smoke. **\$119.95**
Fits '14-later Street Glide® models. Original Equipment on Electra Glide®, Ultra Limited and Tri Glide® models.

58156-08A Dark Smoke. **\$119.95**
Fits '08-'13 Electra Glide, Street Glide and Trike models.

E. ADJUSTABLE AIR DEFLECTOR KIT

Help keep your cool on hot summer rides. The smoked Adjustable Air Deflectors feature a spring-loaded detent system that locks in four different positions. Close the vent to direct airflow around the fairing or open the vent to maximize airflow on hot days. Easy to install, the complete kit includes left and right deflector and all necessary mounting hardware.

57804-07 Light Smoke. **\$119.95**
Fits '96-'13 Electra Glide, Street Glide and Trike models.



E. ADJUSTABLE AIR DEFLECTOR KIT

F. FAIRING AIR DEFLECTORS

Designed to deflect air away from the rider's elbows and upper torso, these easy-to-install Air Deflectors reduce the draft behind the fairing. Fixed-position deflectors are available in your choice of black or smoked finish to match your styling direction.

Fits '96-'13 Electra Glide, Street Glide and Trike models.

58568-98A Black. **\$39.95**

57740-05 Dark Smoke. **\$49.95**

58120-96A Light Smoke. **\$49.95**



F. FAIRING AIR DEFLECTORS

Notice: The prices appearing in this catalog are the manufacturer's suggested retail prices. Actual retail prices may vary.

312 TOURING & TRIKE

Fairing Trim

A. BLACK WINDSHIELD TRIM – GROOVED

Custom billet-look windshield trim accents the outer fairing and dresses your bike in style. The grooved design grabs your eye and adds character to the base of the windshield. Easy to install, the kit includes matching mounting hardware.

61400593 **\$149.95**

Fits '14-later Electra Glide®, Street Glide®, Ultra Limited and Tri-Glide® models.

B. CHROME WINDSHIELD TRIM – GROOVED

Custom polished and chrome-plated billet windshield trim accents the outer fairing and dresses your bike in style. The grooved design grabs your eye and adds character to the base of the windshield. Easy to install, the kit includes stainless steel mounting hardware.

61400224 **\$149.95**

Fits '14-later Electra Glide, Street Glide, Ultra Limited and Tri-Glide models.

C. EDGE CUT WINDSHIELD TRIM

Live your life on the edge. Custom windshield trim features a crisp anodized finish that is machined to expose the highlights of raw aluminum. The contrasting cut back look makes a powerful visual statement and works great with both traditional and contemporary customizing styles. Easy to install, the kit includes stainless steel mounting hardware.

61300358 **\$169.95**

Fits '14-later Electra Glide, Street Glide, Ultra Limited and Tri-Glide models.

D. BAR & SHIELD WINDSHIELD TRIM

This highly polished stainless steel windshield trim is accented by four slots that allow the color of the outer fairing to show through. This unique trim piece is highlighted with Bar & Shield logo machined into the surface. Kit includes stainless steel mounting hardware.

61300275 **\$99.95**

Fits '14-later Electra Glide, Street Glide, Ultra Limited and Tri-Glide models.

59133-99 **\$84.95**

Fits '96-'13 Electra Glide, Street Glide and Trike models.

NEW



A. BLACK WINDSHIELD TRIM – GROOVED



B. CHROME WINDSHIELD TRIM – GROOVED



C. EDGE CUT WINDSHIELD TRIM



D. BAR & SHIELD WINDSHIELD TRIM

Notice: The prices appearing in this catalog are the manufacturer's suggested retail prices. Actual retail prices may vary.

TOURING & TRIKE 313

Fairing Trim



E. WINDSHIELD TRIM – GLOSS BLACK

E. WINDSHIELD TRIM – GLOSS BLACK

Complete the blacked-out look. This easy to install windshield molding accents the outer fairing on batwing fairing equipped models, and simplifies the transition between the fairing and the base of the windshield. Kit includes one-piece trim and required mounting hardware.

61400325 **\$49.95**
Fits '14-later Electra Glide®, Street Glide®, Ultra Limited and Tri Glide® models.

F. WINDSHIELD TRIM – CHROME

Chrome Windshield Molding accents the outer fairing on Electra Glide models. Easily installed, including all necessary hardware and instructions.

61300310 **\$49.95**
Fits '14-later Electra Glide, Street Glide, Ultra Limited and Tri Glide models.

59213-96 **\$44.95**
Fits '96-'13 Electra Glide, Street Glide and Trike models.



F. WINDSHIELD TRIM – CHROME

G. ILLUMINATED WINDSHIELD TRIM

Smoked lenses hide bands of amber LED lamps that glow as running lamps when the ignition is on, and the two outer clusters function as auxiliary directional indicators when the turn signals are activated. The wiring is concealed inside the fairing for a clean, custom appearance. Complete kit includes all necessary mounting hardware.

Fits '14-later Electra Glide, Street Glide, Ultra Limited and Tri Glide models. Installation on CVO™ models requires removal of current windshield trim. Not for use with Three-Pocket Fairing Pouch P/N 93300054B.

57000394A Chrome. **\$199.95**
57000395A Gloss Black. **\$199.95**

H. WINDSHIELD TRIM MIRROR MOUNTING KIT

Put your best look front and center. This Windshield Trim Kit adds a finishing touch to the base of the windshield and positions the rear view mirrors (sold separately) at the fairing's upper edge. The sweeping arms place the mirror shell in a high-mount location, and permit a wide range of up-down-fore-aft adjustability. You get a clean looking handlebar or inner fairing, and a great rear view past your shoulders. Kit includes 3-piece trim and all required mounting hardware. Mirrors sold separately.

57400254 **\$149.95**
Fits '14-later Electra Glide, Street Glide, Ultra Limited and Tri Glide models. FLHX, FLHXS and FLHXSE models equipped with fairing mounted mirrors require separate purchase of Fairing Plug Kit P/N 57300063.

Shown with:

WINDSHIELD TRIM MIRRORS – TAPERED

These Tapered Mirrors are a stylish addition to the Windshield Trim Mirror Mounting Kit P/N 57400254. The mirror provides a large reflective face for a great view to the rear, while the sculpted teardrop-shaped shell is styled to minimize the visual profile. Designed for easy installation and a wide range of adjustability, this kit includes left and right-hand mirror heads.

56000091 **\$149.95**
Fits models equipped with Windshield Trim Mirror Mounting Kit 57400254.



G. ILLUMINATED WINDSHIELD TRIM – GLOSS BLACK



H. WINDSHIELD TRIM MIRROR MOUNTING KIT (SHOWN WITH TAPERED MIRRORS)

TOURING

Notice: The prices appearing in this catalog are the manufacturer's suggested retail prices. Actual retail prices may vary.

314 TOURING & TRIKE

Windshields — Road Glide®

A. WIND SPLITTER WINDSHIELD – ROAD GLIDE®

In the world of functional performance, size does matter. After all, it's simple to understand that the larger the windshield area, the greater the amount of wind deflection. The Wind Splitter Windshield is a great look for all Touring models and is shaped for the perfect combination of effective air flow management and "wow" styling. The sweeping design complements the shape of the fairing and the inner dash panel and adds height over a traditional low-profile wind deflector in the center where it counts. The shape decreases wind noise and improves your ability to hear the motorcycle's sound system. The rich smoked finish does not interfere with your forward view and looks great against any paint color. The easy-to-install Wind Splitter features a center-mount Bar & Shield medallion for a distinctive finishing touch.

Fits '15-later Road Glide® models.

57400271	12" Light Smoke.	\$194.95
57400270	15" Light Smoke.	\$209.95

Fits '98-'13 Road Glide models.

57400093	9" Dark Smoke.	\$159.95
57166-10A	12" Dark Smoke.	\$169.95
57400094	15" Light Smoke.	\$169.95



A. 12" WIND SPLITTER WINDSHIELD – (57400271 SHOWN)



A. 15" WIND SPLITTER WINDSHIELD – (57400270 SHOWN)



A. 9" WIND SPLITTER WINDSHIELD – (57400093 SHOWN)



A. 12" WIND SPLITTER WINDSHIELD – (57166-10A SHOWN)



A. 15" WIND SPLITTER WINDSHIELD – (57400094 SHOWN)

Notice: The prices appearing in this catalog are the manufacturer's suggested retail prices. Actual retail prices may vary.

TOURING & TRIKE 315

Windshields — Road Glide®



B. ROAD GLIDE 19" WINDSHIELD



B. ROAD GLIDE 15.5" WINDSHIELD

B. ROAD GLIDE® WINDSHIELDS

Tailor your bike to your size and riding style. For the best compromise between adequate protection from the elements and a clear view of the road ahead, select a windshield that tops out just below eye level. This reduces helmet buffeting while allowing a view unobstructed by dirt, bugs and rain drops. Harley-Davidson® windshields are formed of hard-coated polycarbonate for strength and scratch resistance and are available in a variety of heights to suit your riding needs.

Fits '15-later Road Glide® models.

57400279	19" Clear.	\$169.95
57400281	15.5" Clear.	\$159.95

C. ROAD GLIDE 4" LOW-PROFILE WINDSCREEN

Sometimes, it's all about style. This minimalistic Low-Profile Windscreen accentuates the curvaceous shape of the Road Glide model's fairing, and hugs the contours of the splitstream vent. The opaque black finish defines the transition from the inner to the outer fairing surfaces, and provides a low, lean look to your custom ride.

57400310	Black.	\$154.95
Fits '15-later Road Glide models. Does not fit with Road Glide Fairing Pouch P/N 93300097.		

D. ROAD GLIDE 6" CONTOURED WIND DEFLECTOR – BLACK

Go low with this Road Glide model windshield that is contoured for a unique style.

57400280	Black.	\$139.95
Fits '15-later Road Glide models.		

E. ROAD GLIDE 19" WINDSHIELD – CLEAR

The tall windshield is approximately 3" taller than stock and is hard-coated for durability.

58283-04B	Fits '04-'13 Road Glide models.	\$174.95
------------------	---------------------------------	-----------------

F. ROAD GLIDE 5" WIND DEFLECTOR – BLACK

Opaque black deflector provides radical styling for the ultimate custom cruiser.

57957-98A		\$119.95
Fits '98-'13 Road Glide models. Will fit with Road Glide Windshield Trim P/N 58519-07.		



C. ROAD GLIDE 4" LOW-PROFILE WINDSCREEN



D. ROAD GLIDE 6" CONTOURED WIND DEFLECTOR – BLACK



E. ROAD GLIDE 19" WINDSHIELD – CLEAR (SHOWN WITH ROAD GLIDE WINDSHIELD TRIM)



F. ROAD GLIDE 5" WIND DEFLECTOR – BLACK

Notice: The prices appearing in this catalog are the manufacturer's suggested retail prices. Actual retail prices may vary.

316 TOURING & TRIKE

Fairing Trim

A. ROAD GLIDE® WINDSHIELD TRIM

The Road Glide® model's shark-like fairing is a bold and captivating styling element, so it requires just the right visual touch to complement the signature look. These elegant Windshield Trim components conceal the base of the windshield and sweep over the center Splitstream vent for a continuous band of "custom". Machined from billet aluminum, these easy-to-install components are available in a variety of finishes to match your customizing direction. Mix and match the black or chrome center piece with your choice of chrome, black, or black and machined aluminum Edge Cut side trim to develop your own unique look. Side Trim Kits include left and right side trim and mounting hardware.

Fits '15-later Road Glide models. Installation requires one Side Trim Kit and one Center Trim Kit.

57400255	Side Trim – Chrome Billet.	\$99.95
57400256	Side Trim – Black Billet.	\$99.95
57400296	Side Trim – Edge Cut.	\$104.95
57400295	Center Trim – Chrome Billet.	\$94.95
57400294	Center Trim – Black Billet.	\$94.95

B. ROAD GLIDE SPLIT WINDSHIELD TRIM

This easy to install, 2-piece trim kit adds a speed-stripe accent to the base of the windshield. Tapered from the leading to the trailing edge, the glass-smooth trim features counter bored mounting holes and flush-mount hardware for a clean, elegant look. Kit includes left and right trim and installation hardware.

Fits '15-later Road Glide models.

57400299	Chrome.	\$124.95
57400320	Satin Black.	\$124.95



A. ROAD GLIDE WINDSHIELD TRIM – CHROME BILLET



A. ROAD GLIDE WINDSHIELD TRIM – BLACK BILLET



A. ROAD GLIDE WINDSHIELD TRIM – EDGE CUT



B. ROAD GLIDE SPLIT WINDSHIELD TRIM – CHROME



B. ROAD GLIDE SPLIT WINDSHIELD TRIM – SATIN BLACK

Notice: The prices appearing in this catalog are the manufacturer's suggested retail prices. Actual retail prices may vary.

TOURING & TRIKE 317

Fairing Trim



**C. ROAD GLIDE WINDSHIELD TRIM – CHROME
(SHOWN WITH CONTOURED WIND DEFLECTOR)**

C. ROAD GLIDE® WINDSHIELD TRIM

The fairing is a key visual element of your bike, so it demands the bold design of this elegant contoured windshield trim. This sweeping trim hugs the curvature of the fairing and conceals the base of the windshield and the windshield gasket for a clean, finished look. The multi-piece design simplifies installation. Kit includes mounting hardware and Road Glide® medallion.

Fits '04-'13 Road Glide® models.

58519-07A	Chrome.	\$149.95
57400150	Gloss Black.	\$149.95

D. ROAD GLIDE COMPARTMENT LINERS

Protect your belongings and reduce noise and rattles on the road. Soft-touch felt finish liner is formed to the fairing glove box interior for a perfect fit. Molded base and sides maximize the interior room and one-piece design allows easy removal for cleaning and maintenance.

76000539 **\$39.95**

Fits '15-later Road Glide models. Right liner includes integrated mobile device storage net.

58932-98 **\$29.95**

Fits '98-'13 Road Glide models.



**C. ROAD GLIDE WINDSHIELD TRIM – GLOSS BLACK
(SHOWN WITH WIND SPLITTER WINDSHIELD)**



**D. ROAD GLIDE COMPARTMENT LINERS
(76000539 SHOWN)**



**D. ROAD GLIDE COMPARTMENT LINERS
(58932-98 SHOWN)**

Notice: The prices appearing in this catalog are the manufacturer's suggested retail prices. Actual retail prices may vary.

318 TOURING & TRIKE

Fairing – Accessories

A. THREE-POCKET BATWING FAIRING POUCH – '14-LATER MODELS

Convenient storage space at your fingertips. Designed to complement H-D® Wind Deflectors and Windshields, this fairing pouch is ideal for storing mobile devices, sunglasses and other small items. The sturdy plastic pouches are wrapped in supple UV-resistant vinyl for a premium look and feel and the magnetic closures keep your items within reach without detracting from the tastefully smooth styling.

93300054B **\$129.95**

Fits '14-later Electra Glide®, Street Glide®, Ultra Limited and Tri Glide® models with windshields. Not for use with Wind Splitter Windshields P/N 57400204 or 57400205. Not for use with Illuminated Windshield Trim P/N 57000394 or 57000395.



A. THREE-POCKET BATWING FAIRING POUCH – '14-LATER MODELS

B. THREE-POCKET BATWING FAIRING POUCH – '96-'13 MODELS

Convenient storage space at your fingertips. Designed to complement H-D Wind Deflectors and Windshields, this fairing pouch is ideal for storing cell phones, sunglasses and other small items. The sturdy plastic pouches are wrapped in supple UV-resistant vinyl for a premium look and feel and the magnetic closures keep your items within reach, while not detracting from the tastefully smooth styling. The left-hand pouch can be easily removed to accommodate your fairing-mounted GPS unit. Attractive Harley-Davidson script is featured on the front center pouch and on the outboard – facing side, visible through the windshield.

58900-11 **\$114.95**

Fits '96-'13 Electra Glide, Street Glide and Trike models. Not for use with Fairing Dash Pads. Models equipped with Illuminated Windshield Molding P/N 57335-08 requires separate purchase of Screws P/N 4456 (Qty 3), Bar & Shield™ Windshield Molding P/N 59133-99 requires separate purchase of Screws P/N 94386-92T (Qty 3), Chrome Windshield Trim P/N 59213-96 requires separate purchase of Screws P/N 94397-91T (Qty 3).



B. THREE-POCKET BATWING FAIRING POUCH – '96-'13 MODELS

C. THREE-POCKET WINDSHIELD POUCH

Add convenient storage space up front where you need it. This easy-to-install windshield pouch features three easily accessible storage pockets sized for cell phones, glasses and other small items. The center pouch is accented with an embossed Harley-Davidson script for a finishing touch.

58904-03 **\$109.95**

Fits King-Size (except Springer™ and Rigid- Mount King Size) and Road King® windshields (except Wind Deflector and Adjustable Height).



B. THREE-POCKET BATWING FAIRING POUCH – '96-'13 MODELS (SHOWN WITH GPS UNIT)



C. THREE-POCKET WINDSHIELD POUCH

Notice: The prices appearing in this catalog are the manufacturer's suggested retail prices. Actual retail prices may vary.

TOURING & TRIKE 319

Fairing – Accessories



D. ROAD GLIDE FAIRING POUCH

D. ROAD GLIDE® FAIRING POUCH

This two pocket Fairing Pouch is ideal for storing mobile devices, sunglasses and other small items. Contoured for a custom fit, the dash pad and pouch system fits perfectly with Harley-Davidson® wind deflectors and windshields. The sturdy molded pouches are wrapped in supple UV-resistant vinyl for a premium look and feel, and the magnetic closures keep your items within reach. The left pouch provides easy access to the Road Glide model's Splitstream vent control button.

93300097

\$154.95

Fit '15-later Road Glide® models. Does not fit with Road Glide Low-Profile Windscreen P/N 57400310.

E. TWO-POCKET WINDSHIELD POUCH

Add convenient storage space up front where you need it. This easy-to-install windshield pouch features two easily accessible storage pockets sized for cell phones, glasses and other small items. Hook-and-loop closures allow easy one-handed opening. Both pouches are accented with an embossed Harley-Davidson logo for a finishing touch.

57203-07

\$109.95

Fits King-Size or Compact windshields. Does not fit FXDWG, FLSTSB or FXSTD models. Does not fit Rigid-Mount, Super Sport, Nostalgic or Flamed windshields.

F. EMBOSSED BAR & SHIELD LOGO LEATHER WINDSHIELD BAG

Black domestic steer hide bag features an embossed Bar & Shield logo.

58308-95

\$99.95

Fits King-Size and Compact windshields (except FXSTD, Flame and Skull with Wings). Does not fit 100th Anniversary logo windshields, models equipped with handlebar mount gauges or Road Tech™ Riser Mount Radio.

G. ROAD KING® CLASSIC LEATHER WINDSHIELD BAG

Leather bag features textured leather insert, H-D concho and a turnbuckle closure.

58189-98

\$114.95

Fits King-Size and Compact windshields (except FXSTD, Flame and Skull with Wings). Does not fit 100th Anniversary logo windshields, models equipped with handlebar mount gauges or Road Tech Riser Mount Radio.



D. ROAD GLIDE FAIRING POUCH – OPEN



E. TWO-POCKET WINDSHIELD POUCH



F. EMBOSSED BAR & SHIELD LOGO LEATHER WINDSHIELD BAG



G. ROAD KING CLASSIC LEATHER WINDSHIELD BAG

Notice: The prices appearing in this catalog are the manufacturer's suggested retail prices. Actual retail prices may vary.

320 TOURING & TRIKE

Fairing Lower

A. FAIRING LOWER FITTED GLOVE BOX LINER KIT

Protect your belongings and reduce noise and rattles on the road. Soft-touch felt finish liner is formed to the fairing glove box interior for a perfect fit. Molded base and sides maximize the interior room and one-piece design allows easy removal for cleaning and maintenance.

57100270 **\$39.95**

Fits '14-later Touring and Trike models equipped with Original Equipment or accessory Vented Fairing Lower. Does not fit Twin-Cooled™ models.

58714-06 **\$29.95**

Fits '05-'13 Touring and Trike models equipped with Vented Fairing Lower.



A. FAIRING LOWER FITTED GLOVE BOX LINER KIT

B. FLT AND FLHT FAIRING LOWER GLOVE BOXES

Offers a convenient place to store riding gloves, sunglasses, etc. The snap-on door cover (included) is embossed with Bar & Shield logo. Available in black only.

Fits '04-earlier Original Equipment non-vented style FLHT Ultra Classic® Fairing Lower.

58683-89B Left Side. **\$174.95**

58684-89B Right Side. **\$174.95**



B. FLT AND FLHT FAIRING LOWER GLOVE BOXES

C. FAIRING LOWER QUICK FLAP MAGNETIC DOORS

The Quick Flap Door Kit enables quick and easy access to fairing lower glove boxes. The flexible covers feature high-strength magnetic catches that replace the Original Equipment snap closures for one-handed access. Kit includes left and right side doors and magnetic catches. Combine with available Glove Box Liners for rattle-free storage.

57100198 **\$59.95**

Fits '83-'13 Road King®, Electra Glide®, Street Glide® and Trike models equipped with vented and non-vented Fairing Lower Glove Boxes and '10-'13 Road Glide® models equipped with vented Fairing Lower Glove Boxes.



C. FAIRING LOWER QUICK FLAP MAGNETIC DOORS

D. FAIRING LOWER QUICK-RELEASE HARDWARE KIT - '14-LATER MODELS

E. SOFT LOWERS

Extend your riding season. Full coverage Soft Lower provide wind and mud protection for the rider's legs and boots and minimize cold updrafts as the weather changes. Covers are custom shaped to hug the engine guard to minimize flapping and they simply clip in place for speedy installation as the weather changes. Two-way zippered outer edge accommodates guard-mounted highway pegs in almost any position. Reflective piping provides added visibility and convenient zippered pockets provide additional storage for maps or other small items.

57100210 **\$94.95**

Fits '80-later Touring and Trike models equipped with engine guards. Does not fit with Original Equipment or accessory Color Matched Fairing Lower. Does not fit Mustache Engine Guards. Does not fit models with Extended Reach Brake Lever or Extended Reach Shift Lever.



E. SOFT LOWERS - FRONT VIEW

E. SOFT LOWERS - REAR VIEW

Notice: The prices appearing in this catalog are the manufacturer's suggested retail prices. Actual retail prices may vary.

TOURING & TRIKE 321

Air Deflectors



F. MID-FRAME AIR DEFLECTOR – (58002-09A SHOWN)



F. MID-FRAME AIR DEFLECTOR

Designed for severe duty and extreme temperature applications. These black deflectors attach to the frame below the seat and direct heat away from the rider to improve comfort. Kit includes all necessary hardware.

58002-09A **\$89.95**

Fits '09-later Touring and Trike models. Not compatible with '17-later models equipped with CoolFlow™ Fan P/N 26800120, 26800121 and 26800128.

57200157 **\$89.95**

Fits '17-later Touring and Trike models equipped with CoolFlow Fan P/N 26800120, 26800121 and 26800128.

58022-07A **\$89.95**

Fits '01-'08 Touring models. Does not fit '01-'07 models equipped with Adjustable Rider Backrests.

G. MID-FRAME AIR DEFLECTOR TRIM

This injection-molded trim adds a touch of chrome to the Mid-Frame Air Deflectors on touring vehicles. These chrome accents blend the look of chrome from the engine and help make the deflectors look integrated with the bike.

61400028 **\$59.95**

Fits '09-later Touring and Trike models with Original Equipment Mid-Frame Air Deflectors. Also fits models equipped with Mid-Frame Air Deflectors P/N 58002-09. Does not fit '17-later models equipped with CoolFlow Fan Kits.



F. MID-FRAME AIR DEFLECTOR – (57200157 SHOWN)



G. MID-FRAME AIR DEFLECTOR TRIM

H. ROAD GLIDE® WIND DEFLECTOR KIT

Easy to install, these snap-fit Wind Deflectors reduce and redirect the airflow that rises between the fairing and fork tubes. The resulting reduction in updraft can dramatically reduce buffeting for many riders.

57000510 **\$44.95**

Fits '15-later Road Glide® models. Stock on '15-later FLTRUSE.

57000063 **\$44.95**

Fits '98-'13 Road Glide models. (Will not fit models equipped with the Fuel Tank retrofit mounting kit.) Stock on '11-'13 CVOT™ Road Glide models.



H. ROAD GLIDE WIND DEFLECTOR KIT



H. WIND DEFLECTOR – (57000510 SHOWN)



H. WIND DEFLECTOR – (57000063 SHOWN)

Notice: The prices appearing in this catalog are the manufacturer's suggested retail prices. Actual retail prices may vary.

322 TOURING & TRIKE

Rider Comfort

A. COOLFLOW™ FAN

Keep your cool on a sweltering summer day. Engineered to maximize rider and passenger comfort in high temperature situations, the CoolFlow™ Fan is the perfect addition if your bike is subjected to parade duty, rush hour traffic, or extreme temperature environments. Unlike traditional fan kits that try to cool the engine by blowing air across the cylinders and often onto your legs, the CoolFlow Fan Kit keeps the riders comfortable by pulling air away from the rear cylinder and exhaust pipe, and directing it toward the ground. The fan suction generates a low pressure region near the riders to balance the natural "up and out" convection air flow in the area behind the engine. The wind-tunnel tested fan is tucked away above the transmission, and when combined with mid-frame air deflectors, significantly drops the temperature the seated rider experiences.

The CoolFlow Fan features switched On/Off/Auto operation on '17-later models and On/Off on '09-'16 models. In the "ON" mode, the fan is active at low speeds, and will turn off when the bike reaches 40mph. As speed drops, the fan turns back on at 35mph. This logic program prevents the fan from cycling on and off during low speed changes. On '17-later models, the AUTO setting operates based on a combination of speed parameters and specific engine and ambient temperatures. Built to withstand the harsh motorcycle environment, the all-weather CoolFlow Fan is 100% waterproof and includes everything you need for installation. The plug-and-play design is integrated with the vehicle electronics, so "On/Off/Auto" fan operation is indicated in the odometer screen. Your dealer will enable this function in the Electronic Control Module (ECM) and you're ready to roll. Odometer fan status display feature availability varies by model and may not be available for your vehicle.

26800121 **\$299.95**
Fits '17-later FLHR, FLHRC, FLHRXS, FLHP, and FLRT models. Does not fit with Starter End Cover P/N 31400088 and 31400090. FLHRC Brazil configurations and FLHP (all regions) require separate purchase of Mid-Frame Air Deflector P/N 57200151. Separate purchase of Mid-Frame Air Deflector Kit P/N 57200157 is recommended for maximum performance on all other vehicles. Dealer Digital Technician update is required to display fan status.

26800120 **\$299.95**
Fits '17-later FLHX, FLHXS, FLHXSE, FLTRX, and FLTRXS models. Does not fit with Starter End Cover P/N 31400088 and 31400090. FLHXS and FLHXSE Brazil configurations require separate purchase of Mid-Frame Air Deflector P/N 57200151. Separate purchase of Mid-Frame Air Deflector Kit P/N 57200157 is recommended for maximum performance on all other vehicles. Dealer Digital Technician update is required to display fan status.

26800128 **\$299.95**
Fits '17-later FLHTCU, FLHTK, FLHTKL, FLHTKSE, FLHTP, FLTRU, and FLTRUSE and FLHTCUTG models. Does not fit with Starter End Cover P/N 31400088 and 31400090. FLHTCUTG (HDI, ENG, HDJ configurations only), FLHTP and FLTRU models require separate purchase of Switch Pack P/N 69200173 and Switch Buttons (2) P/N 71400031. Kit includes replacement right side Mid Frame Air Deflector. Dealer Digital Technician update is required to display fan status.

26800152 **\$299.95**
Fits '09-'16 Touring and Trike models with or without Original Equipment Mid-Frame Air Deflectors. Separate purchase of Mid-Frame Air Deflector Kit P/N 58002-09A is recommended for maximum performance if not equipped.



A. COOLFLOW FAN



A. COOLFLOW FAN (26800120 SHOWN)



A. COOLFLOW FAN (26800128 SHOWN)

NEW



A. COOLFLOW FAN

Notice: The prices appearing in this catalog are the manufacturer's suggested retail prices. Actual retail prices may vary.

TOURING & TRIKE 323

Oil Coolers



B. FAN ASSISTED OIL COOLER

B. FAN ASSISTED OIL COOLER

Keep your cool. This easy to install Oil Cooler features a thermostatically controlled fan that provides continuous flow of cooling air – even while the bike is idling in traffic or moving at low speed. Ideal for bikes that see parade duty and other low speed or continuous idle situations, the Fan Assisted Oil Cooler is also the perfect addition to a bike modified with high performance components. The fan automatically engages when the engine oil temperature rises, and when in operation, the Fan Assisted Oil Cooler can provide up to a 50 degree drop in oil temperature. And unlike other models, the Harley-Davidson® Fan Assisted Oil Cooler utilizes weather-rated fans and electronics that are designed for the harsh motorcycle environment. Engineered as a bolt-on replacement for the Original Equipment oil cooler, the Fan Assisted Oil Cooler is plug-and-play compatible with your bike's wiring harness. No splicing or rewiring is required.

62700204 **\$329.95**

Fits '17-later Touring models equipped with air/oil-cooled Milwaukee-Eight® engines. Does not fit models equipped with Twin-Cooled™ engines. Not compatible with Oil Cooler Cover P/N 25700633 or 25700634. Original Equipment on oil-cooled Police and Freewheeler® models.



C. PREMIUM OIL COOLER KIT – '09-'10 TOURING
(26155-09A SHOWN)

C. PREMIUM OIL COOLER KITS – TOURING

This oil cooler was designed specifically for Harley-Davidson to out-perform all other coolers in the industry. The cooler features a unique "Turbulator" system that evenly distributes oil across the cooling chambers. The air fins are designed to efficiently dissipate heat. The oil cooler has been designed to simplify installation and enhance performance. The large heat exchanger provides excellent cooling efficiency. The kit features a one-piece adapter plate with integrated thermostat that allows oil lines to connect to the oil filter bracket. Thermostat activates at 185°F (85°C). Kit comes complete with mounting hardware and precut oil lines.

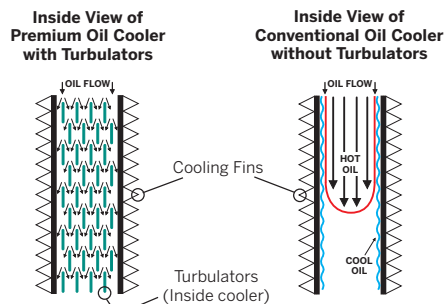

Turbulators disperse and mix oil inside cooler to provide more efficient cooling capabilities. The cooler oil is not allowed to remain along the boundaries of the flow tube as in conventional coolers.

Coolers without the Turbulator system allow oil to flow only in a straight path. Oil does not mix and the cooler oil remains along the outer boundaries, while the hotter oil remains along the center path of flow. Without the mixing effects of the Turbulators, the conventional oil cooler provides less efficient cooling capabilities.



C. PREMIUM OIL COOLER KIT
(26155-07A SHOWN)



C. PREMIUM OIL COOLER KIT
(26082-05C SHOWN)

26155-09A Horizontal Mount. **\$379.95**

Fits '09-'10 Touring models. Does not fit with Voltage Regulator Cover P/N 74538-09, DEFINITIVE5™ Filtration System Kit or models equipped with a sidecar.

26155-07A Horizontal Mount. **\$379.95**

Fits '07-'08 Touring models. Stock on '07-'08 FLHTCUSE. Does not fit with Chrome Display Stand P/N 99002-97A, Voltage Regulator Cover P/N 74538-09, DEFINITIVE5 Filtration System Kit or models equipped with a sidecar.

26082-05C Horizontal Mount. **\$379.95**

Fits '99-'06 Touring models. Does not fit with Chrome Display Stand P/N 99002-97A, Voltage Regulator Cover P/N 74538-09, DEFINITIVE5 Filtration System Kit or models equipped with a sidecar.

Notice: The prices appearing in this catalog are the manufacturer's suggested retail prices. Actual retail prices may vary.

TOURING

COMFORT IS KING

The ability to spend hours behind the handlebars and rack up hundreds of miles without stopping is dictated by how you feel on your bike. The shape of the seat, the reach to the handlebars and the location of your feet are all major factors in how far you can travel in a day. But don't forget your passenger's needs — they have a stake in this ride as well.

THE RIDER & PASSENGER ENVIRONMENT

Accessories that impact the rider and passenger's physical contact with the motorcycle and the management of wind, temperature and road conditions should be your first consideration in building the ultimate touring machine.



RIDER/PASSENGER CONTACT POINTS		RIDER/PASSENGER ENVIRONMENT	
	PAGE #		PAGE #
1 PASSENGER BACKREST	346-350	9 HEATED PASSENGER BACKREST	358
2 PASSENGER ARMRESTS	340	10 HEATED RIDER & PASSENGER SEATING	329,333
3 RIDER BACKREST	338-339	11 HEATED GRIPS	606-607
4 RIDER & PASSENGER SEATING	326-337	12 WINDSHIELDS	305-310
5 HANDLEBAR	635, 640-648	13 WIND DEFLECTORS	311
6 HIGHWAY PEGS	614-615	14 VENTED FAIRING LOWERS	792
7 FOOTBOARDS & FOOT CONTROLS	584-592, 596-605, 610	15 COOLFLOW FAN	322
8 PASSENGER FOOTBOARDS	584-592, 596-605, 611	16 ADJUSTABLE SUSPENSION	387

ENJOY THE RIDE

The relationship between the seat, the handlebar and the foot controls has an enormous impact on the comfort, control, and confidence you feel when riding your motorcycle. Once you've picked the bike, it's time to choose the options that match your ride to your personal dimensions.



For shorter riders, consider tailoring your fit by changing to a Reach® Seat, Standard Foot Controls, and lowered suspension height.



For taller riders, consider altering your ride by changing to a Tallboy® Seat and Extended Foot Controls.

ESTABLISH YOUR POSITION AND FEEL

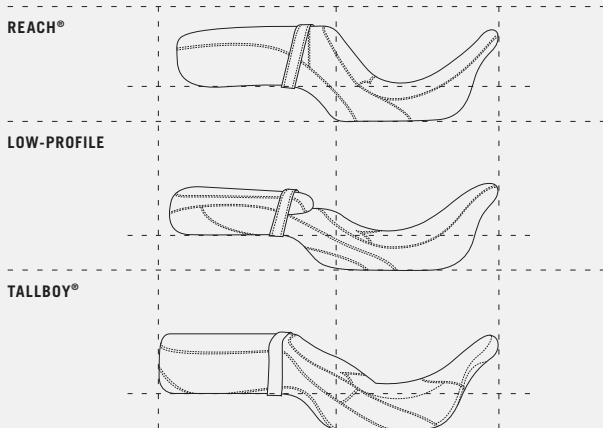

SEATS

Seat height and shape impact rider comfort, fit and confidence. Where the seat positions you relative to the foot controls, hand controls and the ground plays a major role in the quality of your ride.

SEE PAGES 326-337

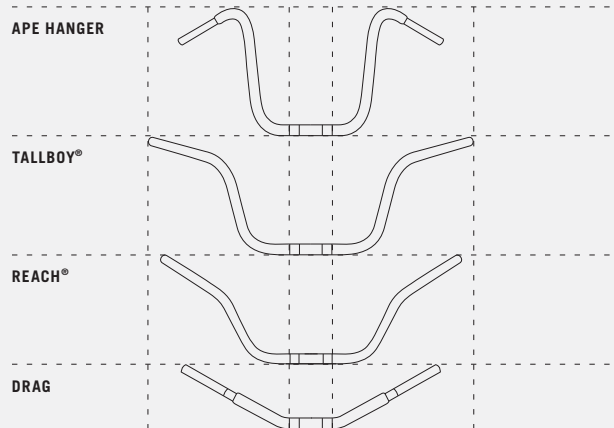

HANDLEBARS

Where the bar positions your arms, hands and wrists directly impacts how you feel on the motorcycle. Choose a bar that falls easily to hand, and does not pull you out of the seat when maneuvering.

SEE PAGES 635, 640-648

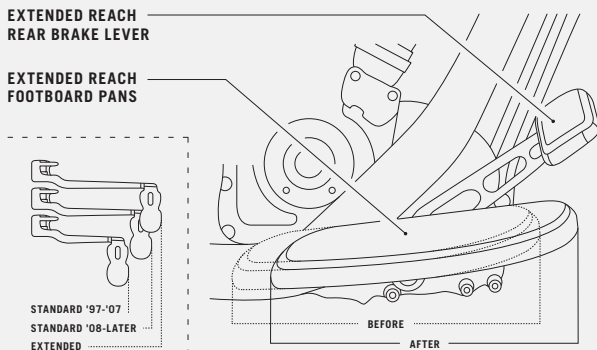

FOOT CONTROLS

Repositioning your feet can relieve muscle tension, take pressure off the tailbone and reduce fatigue. The correct riding position can add hours of comfort and hundreds of miles to your daily saddle time.

SEE PAGES 584-592, 596-605, 610-611

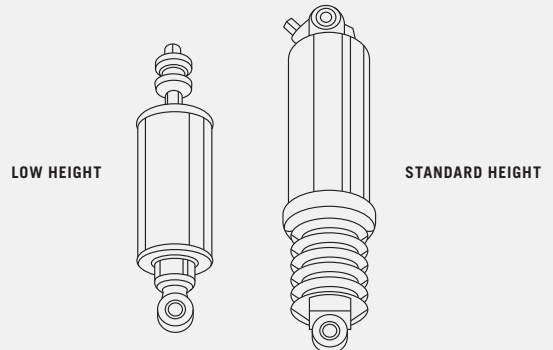

SUSPENSION

Adjusting your motorcycle's ride height by raising or lowering the suspension is often the first step in fitting the bike to your stature. Being sure-footed at a stop can really increase your sense of confidence.

SEE PAGES 386-388

326 TOURING & TRIKE

Seating – Reach®

REACH® SEATS

Designed to position riders with a shorter inseam closer to the ground, Reach® Seats are shaped to place the rider in a comfortable and confident relationship to the hand and foot controls. The wide seating surface provides loads of support while riding and the narrow tapered nose brings your legs together for an easier reach to the ground at a stop. Reach Seats feature a stepped profile that provides back support and keeps the rider from sliding back during acceleration.

A. SUPER REACH SEAT

Get a little bit closer. Super Reach forward position seats are designed to move riders with a shorter inseam even closer to the controls and to bring the legs about 1.0" closer together so that your feet rest firmly on the pavement. The scooped bucket-shape saddle is enhanced with added back support padding to move the rider lower and forward.* The combination positions the rider closer to the hand and foot controls to offer both comfort and confidence. Seat can be equipped with optional rider backrest for added support and comfort.

*Measurements based on Original Equipment Electra Glide® seat:

'09 models – 2.0" lower, 2.5" forward
'10-'13 models – 1.5" lower, 2.5" forward
'14-later models – .5" lower, 2.0" forward

54382-11 **\$374.95**

Fits '09-'13 Touring and Trike models. Also fits '14-later Touring models not equipped with Tour-Pak® luggage. Installation on '12-later CVO™ models requires removal of fender trim strips. Seat width 13.0"; passenger pillion width 12.0".



A. SUPER REACH SEAT

B. REACH SOLO SEAT

From the custom metal Bar & Shield medallion to the sleek fast-back design, this seat is shaped to deliver the ergonomic position that a shorter rider needs. Sculpted and molded to ease the reach to the ground, this Reach Solo seat places the rider 3/8" lower and 1-1/4" forward when compared to the stock FLHX seat*. The narrow nose and the low overall height provides the rider with added confidence and control while the bike is at a stop or during parking maneuvers, while the generous seating width adds support for the long haul. And the seat's upturned tail moves you closer to the controls without confining you to one position. For maximum comfort and support, this seat is recommended for smaller framed riders between 5'-2" and 5'-8" tall.

*Measurement as compared to other seating options:

- Original Equipment 2016 Electra Glide® model seat – 1.25" lower, 0.8" forward
- Original Equipment 2016 Street Glide® model seat – 0.375" lower, 1.25" forward
- Original Equipment 2016 Electra Glide Low model seat – .500" lower, .500" rearward

52000253 **\$339.95**

Fits '09-later Touring models. Does not fit Trike models. Does not fit models equipped with Passenger Grab Rails. Does not accept rider backrest or passenger pillion. Seat width 15.0".



B. REACH SOLO SEAT

C. REACH TWO-UP SEAT – '14-LATER MODELS

Original Equipment on the Ultra Classic® Low and Ultra Limited Low models, this Reach seat brings the legs about 1.0" closer together and features enhanced back support padding that moves the rider .8" lower and 1.5" forward without locking the rider into a cramped position.* The Reach seat can be equipped with an optional rider backrest for additional touring comfort.

*Measurements based on Original Equipment Electra Glide seat.

52000334 **\$374.95**

Fits '14-later Touring and Trike models. Seat width 15.5"; passenger pillion width 16.0".



C. REACH TWO-UP SEAT – '14-LATER MODELS

Notice: The prices appearing in this catalog are the manufacturer's suggested retail prices. Actual retail prices may vary.

TOURING & TRIKE 327

Seating – Reach®



D. REACH TWO-UP SEAT – '09-'13 MODELS

D. REACH® TWO-UP SEAT – '09-'13 MODELS

This Reach® forward position seat brings the legs about 1.0" closer together and features enhanced back support padding that moves the rider lower and forward.* Seat can be equipped with optional rider backrest for added support and comfort.

*Measurements based on Original Equipment

Electra Glide® seat:

'09 models – 1.0" lower, 2.5" forward

'10-'13 models – .5" lower, 2.5" forward

'14-later models – stock height, 2.0" forward

54383-11 **\$374.95**

Fits '09-'13 Touring and Trike models. Also fits '14-later Touring models not equipped with Tour-Pak® luggage. Installation on '12-later CVO™ models requires removal of fender trim strips. Seat width 13.0"; passenger pillion width 12.0".

E. REACH TWO-UP SEAT – '08 MODELS

This Reach forward position seat brings the legs about 1.0" closer together so that feet rest firmly on the pavement and is shaped to move the rider approximately .5" lower* and .5" forward. Seat can be equipped with optional rider backrest for added support and comfort.

*Measurement based on '08 Electra Glide Original Equipment seat.

52619-08A **\$374.95**

Fits '08 Touring and Trike models. Seat width 15.0"; passenger pillion width 13.0".



E. REACH TWO-UP SEAT – '08 MODELS

F. REACH TWO-UP SEAT – '97-'07 MODELS

This Reach forward position seat has a tapered nose to bring the legs closer together. The bucket-shaped pillow-look saddle features added back support padding that moves the rider approximately 1.5" lower and 1.5" forward. Seat can be equipped with an optional Rider Backrest Kit for added support.

52544-05A **\$374.95**

Fits '97-'07 Electra Glide (except FLHX) and '98-'07 Road Glide® models. Seat width 16.0"; passenger pillion width 13.0".

52609-05 **\$374.95**

Fits '97-'07 Road King® (except FLHRS) and FLHX models. Also fits '97-'07 FLHT and FLTR models equipped with Fuel Tank Console P/N 71288-03A or Trim Piece P/N 52447-96. Seat width 16.0"; passenger pillion width 13.0".



F. REACH TWO-UP SEAT – '97-'07 MODELS

Notice: The prices appearing in this catalog are the manufacturer's suggested retail prices. Actual retail prices may vary.

328 TOURING & TRIKE

Seating – Tallboy®

TALLBOY® SEATS

The correct riding position can help a tall rider sit comfortably on the bike and avoid leg cramps and back strain during a long day in the saddle. For riders with a longer inseam, a Tallboy® Seat will put you on the road to fatigue-free riding. Designed to move the rider up and back from the stock seating position, a Tallboy Seat can eliminate the knees-high riding position and effectively places the body for a natural arm and leg reach to the controls. Tallboy Seats feature a bucket-shaped design for added support and a wide seating surface to reduce pressure on the tailbone.

A. TALLBOY SEAT – '14-LATER MODELS

This Tallboy Seat moves the rider back 1.5"* to provide much-needed arm and leg room for the long-limbed rider. The seat is sculpted to provide superior support and comfort, with a slight bucket shape to provide room to vary your riding position fore and aft. The seat's level seating surface does not pitch the rider forward, and the overall ride height is similar to stock Electra Glide® and Road Glide® Ultra seating. Passenger comfort will be maximized with the Tour-Pak® Luggage mounted in the rear most position. Tallboy seats can be equipped with an optional rider backrest (except Adjustable Style) for additional touring comfort.

*Measurements based on Original Equipment Electra Glide seat.

52000252 **\$374.95**

Fits '14-later Touring and Trike models. Not compatible with Adjustable Rider Backrest kits. Seat width 16.5"; passenger pillion width 15.0".

B. TALLBOY SEAT – '08-'13 MODELS

This Tallboy Seat moves the rider back* to provide much-needed arm and leg room for the long-limbed rider. The seat height is similar to stock and the slight bucket shape offers additional lower back support. Passenger comfort will be maximized with the Tour-Pak Luggage mounted in the rear-most position. Accepts rider backrest (except Adjustable Style) for additional touring comfort.

*Measurements based on Original Equipment Electra Glide seat:

'08-'13 models – stock height, 2.0" rearward

'14-later models – stock height, 1.5" rearward

52099-09A **\$374.95**

Fits '08-'13 Touring and Trike models. Also fits '14-later Touring models not equipped with Tour-Pak. Does not fit models equipped with Adjustable Rider Backrest Kits or Passenger Grab Rails. Installation on '12-later CVO™ models requires removal of fender trim strips. Seat width 16.0"; passenger pillion width 14.0".

C. TALLBOY SEAT – '97-'07 MODELS

This Tallboy one-piece seat moves the rider back .5" and up 1.25" compared to the Original Equipment seat. The new position allows additional leg and arm movement for the long-limbed rider and a comfortable seating space for the open road. The bucket design of the Tallboy Seat provides additional rider back support and the wide raised pillion places the passenger for maximum comfort and commanding view. Can also be used with Rider Backrest Kits.

52975-05 **\$374.95**

Fits '97-'07 Electra Glide (except FLHX) and Road Glide® models. Seat width 17.5"; passenger pillion width 15.0".

52976-05 **\$374.95**

Fits '97-'07 Road King® and FLHX models. Also fits '97-'07 Electra Glide and Road Glide models equipped with Fuel Tank Console P/N 71288-03A or Trim Piece P/N 52447-96. Seat width 17.0"; passenger pillion width 16.0".



A. TALLBOY SEAT – '14-LATER MODELS



B. TALLBOY SEAT – '08-'13 MODELS



C. TALLBOY SEAT – '97-'07 MODELS

Notice: The prices appearing in this catalog are the manufacturer's suggested retail prices. Actual retail prices may vary.

TOURING & TRIKE 329

Seating – Signature & Sun Ray®



D. SIGNATURE SERIES SOLO SEAT WITH RIDER BACKREST (SHOWN WITH MATCHING PASSENGER PILLION)

D. SIGNATURE SERIES® SOLO SEAT WITH RIDER BACKREST

The perfect combination of foam density and shape has resulted in our most comfortable seat for long-haul touring. The seat is shaped with a wide seating area to spread the pressure across the broad surface and a narrow nose area to keep your legs together for a shorter reach to the ground. The Signature Series® Solo Seat features a built-in, fully adjustable and removable rider backrest for added support. The backrest provides a 5-position height adjustment with 1.5" range and a wide range of forward/back adjustment with a quick twist of the control knob. The backrest pad features a sleek shape that provides full lower back support without pushing the rider forward. When combined with the comfortable Passenger Pillion P/N 52000133 or 51770-09 (sold separately), the slim profile of the rider backrest offers the passenger a few more inches of space and the fold-down design permits easy passenger mounting/dismounting. The rich vinyl seating surface is easy to clean and maintain and features an embossed Bar & Shield logo on the side skirts for a finishing touch.

51700-09 **\$529.95**
Fits '08-later Touring models. Seat width 16.5".

Shown with:

SIGNATURE SERIES PASSENGER PILLION

This easy-to-install pillion is designed for long range passenger comfort. The wide seating surface and specific-density padding reduce pressure points and spread the weight for superior support. The smooth cover matches the Signature Series Solo Seat and the embossed Bar & Shield logo on the rear shows everyone that you are riding in style. Add a matching Smooth Passenger Backrest for the complete look.

52000133 **\$174.95**
Fits '14-later Touring models equipped with Solo Seat P/N 51700-09. Pillion width 15.0".

51770-09 **\$169.95**
Fits '08-'13 Touring models equipped with Solo Seat P/N 51700-09. Also fits '14-later Touring models not equipped with Tour-Pak® Luggage Carrier. Installation on '12-later CVO™ models requires removal of fender trim strips. Passenger Pillion width 15.0".



E. SUN RAY HEATED SEAT – '14-LATER MODELS

E. SUN RAY® HEATED SEAT – '14-LATER MODELS

Chase away the chill on long fall and winter rides. This second generation heated seat features dual-zone heated rider and passenger positions with separate high/low/off toggle controls for personal comfort selection. The one-piece seat with integrated heat pad and control system is simple to install and the heating element is switched on/off with the ignition to avoid draining the battery. Smooth styling complements any Touring model. Can be used with optional Rider Backrest Kits.

52000135 Vinyl. **\$824.95**
Fits '14-later Touring and Tri Glide® models. '14-'16 models require separate purchase of Electrical Harness Extension P/N 69200722. '17-later models require Electrical Harness Extension P/N 69201599A. Seat width 15.0"; passenger pillion width 15.0".



F. SUN RAY HEATED SEAT – '97-'07 MODELS

F. SUN RAY HEATED SEAT – '97-'07 MODELS

Chase away the chill on long fall and winter rides. This Sun Ray® Heated Seat features dual-zone heated rider and passenger positions with separate high/low/off toggle controls for personal comfort selection. The durable leather seating surface with embossed ostrich skin pattern covers a deep bucket rider seat and a supportive passenger pillion for cross-country comfort. The one-piece seat with integrated heat pad and control system is simple to install and the heating element is switched on/off with the ignition to avoid draining the battery. Can be used with Rider Backrest Kits.

51718-06 Leather. **\$999.95**
Fits '97-'07 Electra Glide® (except FLHX) and '98-'07 Road Glide® models. Seat width 17.0"; passenger pillion width 16.0".

Notice: The prices appearing in this catalog are the manufacturer's suggested retail prices. Actual retail prices may vary.

330 TOURING & TRIKE

Seating – Sundowner™

SUNDOWNER™ SEATS

The Sundowner™ Seat provides the maximum in long-riding comfort. The deep-bucket design puts your body in the proper touring position and the generous padding makes it comfortable for both the rider and passenger as the miles are adding up. The dish-shaped back provides added rider back support and the wide passenger pillion is shaped to minimize pressure points.

A. SUNDOWNER SEAT – SMOOTH

The smooth cover complements any Touring model. Seat accepts rider backrest for additional touring comfort.

52000128 **\$359.95**
Fits '14-later Touring and Tri Glide® models. Seat width 14.5"; passenger pillion width 13.0".

52093-08A **\$359.95**
Fits '08-'13 Touring and Trike models. Also fits '14-later Touring models not equipped with Tour-Pak® luggage. Installation on '12-later CVO™ models requires removal of fender trim strips. Seat width 16.0"; passenger pillion width 14.0".

51726-05 **\$359.95**
Fits '97-'07 Road King® and FLHX models. Also fits '97-'07 Electra Glide® and Road Glide® models equipped with Fuel Tank Console P/N 71288-03A or Trim Piece P/N 52447-96. Seat width 15.0"; passenger pillion width 12.0".

51542-01B **\$359.95**
Fits '97-'07 Electra Glide (except FLHX) and Road Glide models. Seat width 16.0"; passenger pillion width 13.5".

B. SUNDOWNER SEAT – FREEWHEELER®

This Sundowner seat is finished in rich black vinyl and is styled to complement the Freewheeler® Trike model's Original Equipment seat.

52000183 **\$359.95**
Fits '15-later FLRT models. Seat width 15.0"; passenger pillion width 11.0".

C. SUNDOWNER SEAT – ROAD KING® CLASSIC BASKETWEAVE

Decorated with a pleated leather valance and chrome Road King Classic concho, the seat stays true to Road King Classic styling. Accepts rider backrest for additional touring comfort.

51615-09A **\$399.95**
Fits '08-'13 Touring and Trike models. Also fits '14-later Touring models not equipped with Tour-Pak. Installation on '12-later CVO models requires removal of fender trim strips. Seat width 16.0"; passenger pillion width 14.0".

51615-99C **\$399.95**
Fits '97-'07 Road King and FLHX models. Also fits '97-'07 Electra Glide and Road Glide models equipped with Fuel Tank Console P/N 71288-03A or Trim Piece P/N 52447-96. Seat width 15.0"; passenger pillion width 12.0".



A. SUNDOWNER SEAT – SMOOTH
(52000128 SHOWN)



B. SUNDOWNER SEAT – FREEWHEELER



C. SUNDOWNER SEAT – ROAD KING CLASSIC BASKETWEAVE
(51615-09A SHOWN)

Notice: The prices appearing in this catalog are the manufacturer's suggested retail prices. Actual retail prices may vary.

TOURING & TRIKE 331

Seating – Sundowner™



D. SUNDOWNER SEAT – '06-'10 STREET GLIDE STITCHING
(51630-09A SHOWN)

D. SUNDOWNER™ SEAT – '06-'10 STREET GLIDE® STITCHING

Decorated with tuck and roll pleating, the Sundowner™ Seat complements the '06-'10 Street Glide® styling. Accepts rider backrest for additional touring comfort.

51630-09A **\$399.95**

Fits '08-'13 Touring and Trike models. Also fits '14-later Touring models not equipped with Tour-Pak® luggage. Installation on '12-later CVO™ models requires removal of fender trim strips. Seat width 16.0"; passenger pillion width 14.0".

51630-06 **\$399.95**

Fits '97-'07 Road King® and FLHX models. Also fits '97-'07 Electra Glide® and Road Glide® models equipped with Fuel Tank Console P/N 71288-03A or Trim Piece P/N 52447-96. Seat width 15.0"; passenger pillion width 12.0".

E. SUNDOWNER SEAT – ROAD KING® BLACK STUDS

Decorated with black studs and the embroidered Road King V-logo, the seat stays true to Road King styling. Accepts rider backrest as well for additional touring comfort.

51617-99C **\$399.95**

Fits '97-'07 Road King and FLHX models. Also fits '97-'07 Electra Glide and Road Glide models equipped with Fuel Tank Console P/N 71288-03A or Trim Piece P/N 52447-96. Seat width 15.0"; passenger pillion width 12.0".



E. SUNDOWNER SEAT – ROAD KING BLACK STUDS
(SHOWN WITH ROAD KING PASSENGER BACKREST PAD)

F. SUNDOWNER SOLO SEAT – SMOOTH

Only one can sit on the throne. This unique seat combines the deep bucket design and added back support of the two-up Sundowner Seat with the stripped-down look of a solo saddle. Same great comfort as the popular two-up version, but in a solo. Matching passenger pillion is available for added versatility.

51928-01 **\$299.95**

Fits '97-'07 Road King (except FLHRS) and FLHX models. Also fits '97-'07 Electra Glide and Road Glide models equipped with Fuel Tank Console P/N 71288-03A or Trim Piece P/N 52447-96. All models (except FLHR) require separate purchase of Solo Seat Hardware Kit P/N 52903-01. Does not accept rider backrest. Seat width 16.0".

Shown with:

SUNDOWNER PASSENGER PILLION – SMOOTH

This sculpted pillion provides your passenger with the same cushioned comfort as your Solo Sundowner Seat.

51929-01 **\$179.95**

Fits '97-'07 Touring models equipped with an Original Equipment or accessory solo seat (except Brawler® Solo seats). Passenger pillion width 12.5".



F. SUNDOWNER SOLO SEAT – SMOOTH
(SHOWN WITH SUNDOWNER PASSENGER PILLION)

Notice: The prices appearing in this catalog are the manufacturer's suggested retail prices. Actual retail prices may vary.

332 TOURING & TRIKE

Seating – Harley® Hammock

A. HARLEY® HAMMOCK TOURING SEATS

Stay in the saddle all day. These Harley® Hammock Seats feature broad seating surfaces and a shallow bucket shape to distribute the weight and reduce pressure points. Beneath the two inches of traditional dual-density foam, the rider's weight is supported by a revolutionary fabric suspension system. The sling-like suspension system is integrated into the seat and acts like a hammock, providing two inches of suspension above the seat pan. This internal system prevents bottoming out and provides a 30% improvement in comfort and endurance over the long haul by sheltering the rider from pothole and highway expansion joint impacts. The generous seat length permits freedom of movement on long rides, making this seat a perfect option for taller riders.



A. HARLEY HAMMOCK RIDER AND PASSENGER TOURING SEAT

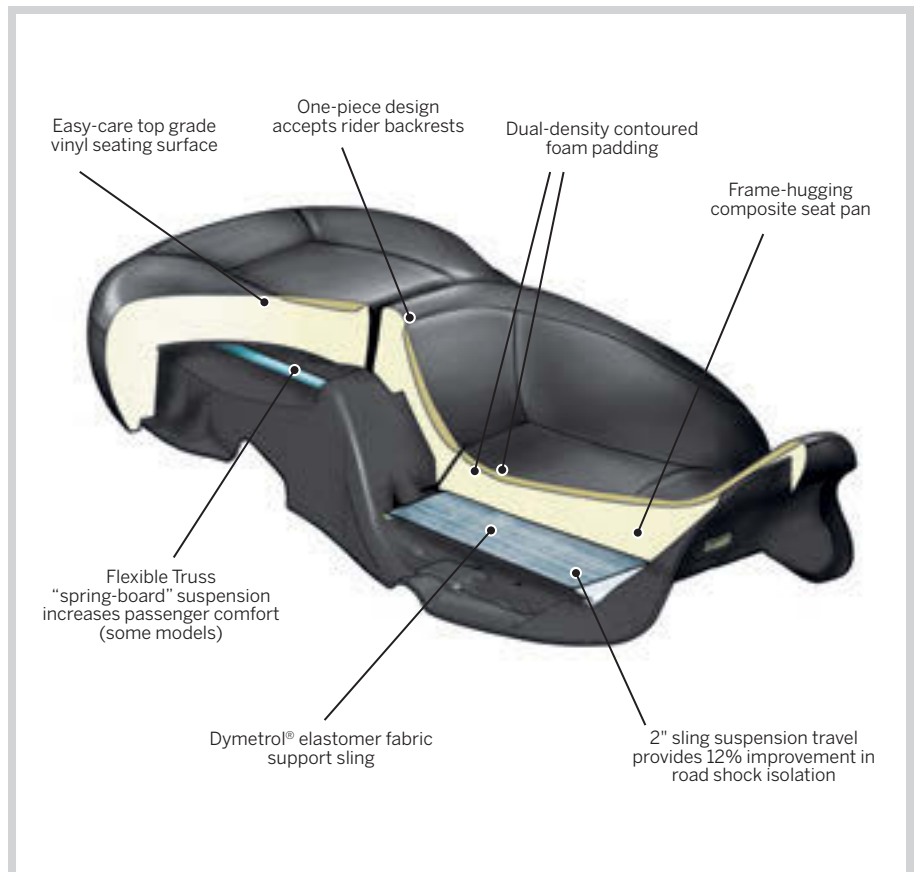

A. HARLEY HAMMOCK RIDER AND PASSENGER TOURING SEAT

Notice: The prices appearing in this catalog are the manufacturer's suggested retail prices. Actual retail prices may vary.

TOURING & TRIKE 333

Seating – Harley® Hammock



A. HARLEY HAMMOCK RIDER AND PASSENGER TOURING SEAT – '14-LATER MODELS



A. HARLEY HAMMOCK RIDER AND PASSENGER TOURING SEAT – '97-'13 MODELS



B. HARLEY HAMMOCK RIDER TOURING SEAT – '08 MODELS

A. HARLEY® HAMMOCK RIDER AND PASSENGER TOURING SEAT

Protect the backside of both rider and passenger from harsh road conditions. With its revolutionary suspension systems, this Harley® Hammock Rider and Passenger Touring systems, offers increased isolation from sharp road impacts. For the rider, sling-like fabric suspension system acts like a hammock to reduce impacts and the two inches of traditional foam on top provides additional support. For the passenger, a multiple spring-board style suspension system along with two inches of traditional foam provides 15% improvement in passenger comfort. When compared to the Hammock Seat offered on select '14-later CVO™ models, this Hammock Seat reduces the bucket shape to accommodate a wide variety of rider sizes and allows fore-and-aft movement to vary the position on a long ride. Available with or without dual-zone heated rider and passenger seating areas, this seat's vinyl surface is easy to clean and maintain. Can be equipped with Rider Backrest (sold separately) on most models.

Standard Harley Hammock Seat

52000176 Without Heat. **\$574.95**

Fits '14-later Touring and Tri Glide® models. Installation on '14-later Tri Glide models requires removal of grab rail. Seat width 17.0"; passenger pillion width 15.0".

5200003A Without Heat. **\$574.95**

Fits '09-'13 Touring and Trike models. Also fits '14-later Touring models not equipped with Tour-Pak® luggage. Trike models require separate purchase of Paint Guard Kit P/N 52000013. Does not fit models equipped with Passenger Grab Rail. Installation on '12-later CVO™ models requires removal of fender trim strips. Seat width 17.5"; passenger pillion width 15.0".

52000072 Without Heat. **\$574.95**

Fits '97-'07 Electra Glide® and Road Glide® models. Seat width 18.0"; passenger pillion width 15.5".

52000075 Without Heat. **\$574.95**

Fits '97-'07 Road King® and FLHX models. Seat width 18.0"; passenger pillion width 15.5".

Heated Harley Hammock Seat

Heated Harley Hammock seats feature switch-activated dual-zone controls for rider and passenger.

52000177 With Heat. **\$899.95**

Fits '14-later Touring and Tri Glide models. '14-'16 models require separate purchase of Electrical Harness Extension P/N 69200722. '17-later models require Electrical Harness Extension P/N 69201599A. Installation on '14-later Tri Glide models requires removal of grab rail. Seat width 17.0"; passenger pillion width 15.0".

5200004A With Heat. **\$899.95**

Fits '09-'13 Touring and Trike models. Also fits '14-later Touring models not equipped with Tour-Pak luggage. '14-'16 models require separate purchase of Electrical Harness Extension P/N 69200722. '17-later models require Electrical Harness Extension P/N 69201599A. Trike models require separate purchase of Paint Guard Kit P/N 52000013. Does not fit models equipped with Passenger Grab Rail. Installation on '12-later CVO models requires removal of fender trim strips. Seat width 17.5"; passenger pillion width 15.0".

B. HARLEY HAMMOCK RIDER TOURING SEAT

This Harley Hammock Seat coddles the rider and supports their weight with a wide seating surface and the revolutionary sling-like fabric suspension system. The passenger rides on a generous pillion of dual-density foam, shaped for support and long-haul comfort. The Harley Hammock Seat's vinyl surface is easy to clean and maintain and is finished with a Harley-Davidson raised script logo. Can be equipped with Rider Backrest (sold separately) on most models.

53051-09 **\$574.95**

Fits '08 Touring models equipped with Tour-Pak luggage. Does not fit models equipped with Passenger Grab Rail. Seat width 17.5"; passenger pillion width 15.0".

334 TOURING & TRIKE

Seating — Road Zeppelin®

ROAD ZEPPELIN® AIR ADJUSTABLE SEATS

The open road. That's where we developed and tested the revolutionary comfort of the Road Zeppelin® Seat. This remarkable seat removes pressure points and hot spots by adjusting the amount of air contained in each bladder within the seat. Easy-to-reach rocker switches on the side of the seat control the built-in compressor, adding and bleeding off air with the quick push of a button to help relieve stress from the lower back, tail-bone or lower extremities. On a long run, occasionally inflating and deflating the air bladders reduces the "numb butt" effect by improving the blood flow to the extremities. So grab a seat. And enjoy the ride.

A. ROAD ZEPPELIN AIR ADJUSTABLE SEAT

The Road Zeppelin seat's ergonomically-friendly design combines a narrow front nose for ease of touching the ground at a stop with a wide seating surface for long range rider and passenger comfort. The easy-to-clean vinyl seat is finished with an embroidered Road Zeppelin logo that lets everyone see that you take riding comfort seriously. The slotted seat accepts an optional rider backrest or passenger grab rail for additional touring comfort.

52000201

\$749.95

Fits '08-later Touring and '09-later Tri Glide® models. '14-'16 models require separate purchase of Electrical Harness Extension P/N 69200722. '17-later models require Electrical Harness Extension P/N 69201599A. Installation on some '12-'13 CVO™ models requires removal of fender trim strips. Seat width 20.0"; passenger pillion width 14.5".

Passenger Zone

Press the 3rd button to inflate and deflate the passenger area, providing maximum comfort to the backbone and support to the thigh area.

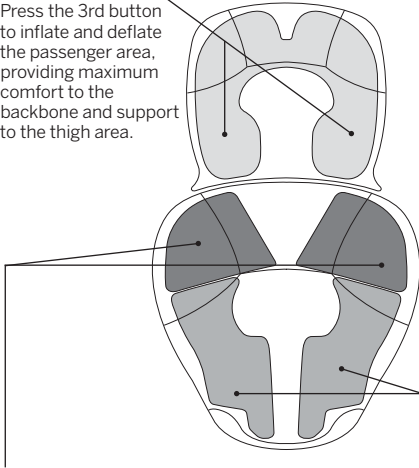

Lower Back Zones

Press the 2nd button (rider only) to adjust the support in the lower back zone chambers, relieving pressure points in the lower back.

Thigh Zones

Press the 1st button to adjust pressure in the two thigh zone chambers, improving blood flow to lower extremities and adding support to thighs.

'08-LATER MODELS



A. ROAD ZEPPELIN AIR ADJUSTABLE SEAT



A. ROAD ZEPPELIN AIR ADJUSTABLE SEAT – CONTROL PANEL

Notice: The prices appearing in this catalog are the manufacturer's suggested retail prices. Actual retail prices may vary.

TOURING & TRIKE 335

Seating — Road Zeppelin®

B. ROAD ZEPPELIN® AIR ADJUSTABLE SEAT – LEATHER – '97-'07 MODELS

This premium seat features leather seating surfaces for long-distance touring comfort. Kit includes protective rain cover.

52333-97E Leather. **\$939.95**

Fits '97-'07 Electra Glide® (except FLHX) and Road Glide® models. Seat width 21.0"; passenger pillion width 17.0".

Shown with:

ROAD ZEPPELIN PASSENGER BACKREST FOR KING TOUR-PAK® LUGGAGE

Styled to match the tufted leather Road Zeppelin® seat.

52335-97A **\$309.95**

Fits '97-'13 Touring and Trike models equipped with King Tour-Pak® luggage.



B. ROAD ZEPPELIN AIR ADJUSTABLE SEAT – LEATHER – '97-'07 MODELS (SHOWN WITH RIDER AND PASSENGER BACKREST)

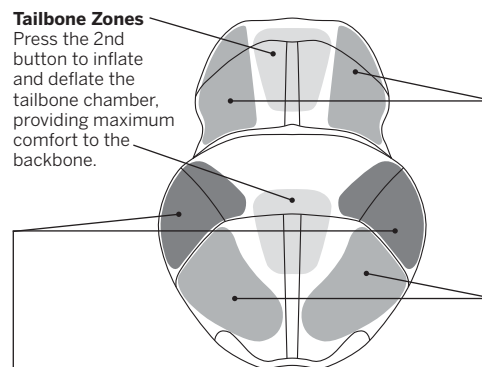

Tailbone Zones

Press the 2nd button to inflate and deflate the tailbone chamber, providing maximum comfort to the backbone.

Lower Back Zones

Press the 3rd button (rider only) to adjust the support in the lower back zone chambers, relieving pressure points in the lower back.

Thigh Zones

Press the 1st button to adjust pressure in the two thigh zone chambers, improving blood flow through the lower extremities.

'97-'07 MODELS



B. ROAD ZEPPELIN AIR ADJUSTABLE SEAT – CONTROL PANEL

NOTE: Some Harley-Davidson® seats are made of leather. Fine leathers or other natural materials WILL gain "character," such as wrinkles or wear, with age. This is normal. A fine, aged patina and character wrinkles are a sign of the extremely high quality materials used to construct your seat or backrest. The appearance of scars or marks on the leather are a result of using natural leather panels and should not be thought of as an imperfection. Please use Harley-Davidson Leather Protectant P/N 93600034 to protect your investment.

Notice: The prices appearing in this catalog are the manufacturer's suggested retail prices. Actual retail prices may vary.

336 TOURING & TRIKE

Seating – Low Profile

A. BRAWLER® SOLO SEAT

When it's time to go it alone, go in style. These premium quality cowhide leather solo saddles feature a smooth, sleek design that hugs the frame rails for a true custom look. The Brawler® seat's design places the rider "in" the bike for a low-slung riding position, and features a "kick-up" in the rear to hold the rider in place. The seating position is generally lower than stock, but not as far back as Badlander or other low profile seats. The top-grain leather seating surface and contoured foam padding provide a firm but luxurious feel. Seat does not fit with passenger pillions.

52000268 **\$349.95**

Fits '08-later Touring models. Does not fit Trike models. Does not fit models equipped with Passenger Grab Rails. Does not accept rider backrest. Seat width 13.0".



A. BRAWLER SOLO SEAT

B. LEATHER BADLANDER® SEAT

The traditional Badlander® seat's low and lean style sets the stage for your minimalist custom ride. The frame-hugging rider seat and the slim tapered passenger pillion visually stretch the bike and enhance the slammed look. The seat shape stays low along its entire length and follows the lines of the bike with minimal disruption, and delivers a riding position that is lower and generally further back than the stock seat. Ideal for both short riders needing to be closer to the ground, or for tall riders that want to bove back in the bike without sitting higher. This seat is wrapped in supple top-grain leather and finished with an embroidered Harley-Davidson script. Kit includes leather grab strap and mounting hardware.

52000257 **\$394.95**

Fits '08-later Touring models. Does not fit Trike models. Installation on '12-later CVO™ models requires removal of fender trim strips. Seat width 13.0"; passenger pillion width 6.0".



B. LEATHER BADLANDER SEAT

C. BADLANDER SEAT

Clean smooth covers, subtle top-stitching and a frame-hugging profile add up to a statement only Harley could create. The low design delivers a reduced seat height that is ideal for riders that want the shortest possible reach to the ground, and the long and lean shape allows tall riders to move back from the hand and foot controls without sitting higher on the bike. Kit includes grab strap and all mounting hardware. Does not accept a rider backrest.

52067-08A **\$309.95**

Fits '08-later Touring models. Does not fit Trike models. Installation on '12-later CVO models requires removal of fender trim strips. Seat width 13.0"; passenger pillion width 6.0".

52066-97C **\$309.95**

Fits '97-'07 Road King® (except FLHRS) and FLHX models. Also fits '97-'07 Electra Glide® and Road Glide® models equipped with Fuel Tank Console P/N 71288-03A or Trim Piece P/N 52447-96. Seat width 12.25"; passenger pillion width 4.5".

52265-01A **\$309.95**

Fits '97-'07 Electra Glide (except FLHX) and Road Glide models. Seat width 12.5"; passenger pillion width 4.5".



C. BADLANDER SEAT

D. LEATHER LOW-PROFILE BUCKET SEAT

A custom-look low and slammed seat, with a bucket contour for added support. Features embroidered logo and an opening that receives a matching Rider Backrest.

52095-08A **\$349.95**

Fits '08-later Touring and Tri Glide® models. Installation on '12-later CVO models requires removal of fender trim strips. Seat width 15.0"; passenger pillion width 8.5".

52918-98B **\$349.95**

Fits '97-'07 Road King (except FLHRS) and FLHX models. Also fits '97-'07 Electra Glide and Road Glide models equipped with Fuel Tank Console P/N 71288-03A or Trim Piece P/N 52447-96. Seat width 15.7"; passenger pillion width 6.5".



D. LEATHER LOW-PROFILE BUCKET SEAT

NOTE: Some Harley-Davidson® seats are made of leather. Fine leathers or other natural materials WILL gain "character," such as wrinkles or wear, with age. This is normal. A fine, aged patina and character wrinkles are a sign of the extremely high quality materials used to construct your seat or backrest. The appearance of scars or marks on the leather are a result of using natural leather panels and should not be thought of as an imperfection. Please use Harley-Davidson Leather Protectant P/N 93600034 to protect your investment.

Notice: The prices appearing in this catalog are the manufacturer's suggested retail prices. Actual retail prices may vary.

TOURING & TRIKE 337

Seating – Low Profile



**E. LOW-PROFILE SOLO TOURING SEAT – SMOOTH VINYL
(SHOWN WITH LOW-PROFILE PASSENGER PILLION)**

LOW-PROFILE SOLO TOURING SEATS AND PILLIONS

Set your custom bagger apart with a Low-Profile Solo Seat that combines street-rod style with a surprising touch of comfort. Start with a shape that distributes your weight across a wide surface area to reduce pressure points. Then, add a tapered nose that brings the legs closer together to shorten the reach to the ground. The result is the slammed custom seat that you crave; with enough comfort and support to let you actually spend time in the saddle. Finish the look with your choice of matching passenger pillion, sissy bar pad and Tour-Pak® backrest pad.

E. LOW-PROFILE SOLO TOURING SEAT – SMOOTH VINYL

Wrapped in supple black vinyl, this Low Profile Solo Seat is shaped to hug the frame and place the rider "in" the bike – not on top of it. The slight bucket shape cradles the rider, and keeps them from sliding rearward during acceleration.

52000249 **\$299.95**

Fits '09-later Touring models. Does not fit Trike models. Does not accept Rider Backrest. Seat width 15.0".

Shown with:

LOW-PROFILE PASSENGER PILLION – SMOOTH VINYL

Enveloped in smooth black vinyl, this Passenger Pillion is the perfect complement to the Smooth Vinyl Low-Profile Solo Seat. Easy on-and-off installation lets you change from a two-up tourer to a stripped-down cruiser in seconds. Includes matching grab strap.

52400141 **\$199.95**

Fits '09-later Touring models equipped with Solo Seat P/N 52000249. Pillion width 11.0". Does not fit Trike models.

F. LOW-PROFILE SOLO TOURING SEAT – BLACK DIAMOND

Swathed in textured black vinyl, this Low Profile Solo Seat features a custom diamond-pleated seating surface highlighted with double-row toast-colored accent stitching. The rich materials add an elegant finish to your custom bagger.

52000248 **\$359.95**

Fits '09-later Touring models. Does not fit Trike models. Does not accept Rider Backrest. Seat width 15.0".

Shown with:

LOW-PROFILE PASSENGER PILLION – BLACK DIAMOND

Layered in a combination of smooth and textured black vinyl, this Passenger Pillion is the perfect complement to the Black Diamond Low-Profile Solo Seat. Easy on-and-off installation lets you change from a two-up tourer to a stripped-down cruiser in seconds. Includes matching grab strap.

52400140 **\$274.95**

Fits '09-later Touring models equipped with Solo Seat P/N 52000248. Pillion width 11.0". Does not fit Trike models.

G. LOW-PROFILE SOLO TOURING SEAT – MAHOGANY BROWN

Finished with a rich textured mahogany-brown vinyl and upholstered in a custom diamond-pleat pattern with complementing double-row gold stitching, this Low Profile Solo Seat brings a non-traditional look to your Touring model.

52000057 **\$359.95**

Fits '09-later Touring models. Does not fit Trike models. Does not accept Rider Backrest. Seat width 15.0".

Shown with:

LOW-PROFILE PASSENGER PILLION – MAHOGANY BROWN

Dressed in rich textured brown vinyl and finished with elegant gold stitching, this Passenger Pillion is the perfect complement to the Mahogany Brown Solo Seat. Easy on-and-off installation lets you change from a two-up tourer to a stripped-down cruiser in seconds. Includes matching grab strap.

52400040 **\$274.95**

Fits '09-later Touring models equipped with Solo Seat P/N 52000057. Pillion width 11.0". Does not fit Trike models.



**F. LOW-PROFILE SOLO TOURING SEAT – BLACK DIAMOND
(SHOWN WITH LOW-PROFILE PASSENGER PILLION)**



**G. LOW-PROFILE SOLO TOURING SEAT – MAHOGANY BROWN
(SHOWN WITH LOW-PROFILE PASSENGER PILLION)**

Notice: The prices appearing in this catalog are the manufacturer's suggested retail prices. Actual retail prices may vary.

338 TOURING & TRIKE

Seating — Rider Backrests

A. ADJUSTABLE RIDER BACKRESTS

Add support for the long haul. With one quick pull from the integrated gas spring, you can instantly adjust the riding position through a 30-degree range. The backrest pad features a sleek shape that provides full lower back support without pushing the rider forward and a slim profile that offers the passenger a few more inches of space. The backrest features a pull knob-activated, five-position, 1.5" height adjustment. The backrest can be easily removed and folds down to allow easier passenger mounting.

Fits '97-later Touring and Trike models equipped with many one-piece slotted seats. This rider backrest may not look appropriate on select Original Equipment, CVO™ seats and accessory seats that are styled with a low-profile look. Installation requires separate purchase of model-specific Adjustable Rider Backrest Mounting Kit.

1. 52423-09A	Comfort Stitch Style.	\$114.95
2. 52591-09A	Road King® Classic Style.	\$129.95
3. 52546-09A	'06-'10 Street Glide® Style.	\$114.95
4. 52501-09A	Smooth Style.	\$114.95

Shown with:

ADJUSTABLE RIDER BACKREST MOUNTING KIT

Kit includes mounting bracket, adjustment handle and all required installation hardware.

52596-09A **\$219.95**
Required to install Adjustable Rider Backrest on '09-later Touring models. Does not fit Trike models.

54099-10 **\$219.95**
Required to install Adjustable Rider Backrest on '09-later Tri Glide® models. Also fits '15-later Freewheeler® models equipped with Sundowner™ Seat P/N 52000183.

52593-09A **\$219.95**
Required to install Adjustable Rider Backrest on '97-'08 Touring models.



Pull knob in the center of backrest pad to adjust vertically to five different heights.

Push tab on side of frame to adjust angle of backrest pad 30° forward or backward.

A. ADJUSTABLE RIDER BACKREST KITS



A. ADJUSTABLE RIDER BACKRESTS (SHOWN WITH MOUNTING KIT)

Notice: The prices appearing in this catalog are the manufacturer's suggested retail prices. Actual retail prices may vary.

TOURING & TRIKE 339

Seating — Rider Backrests

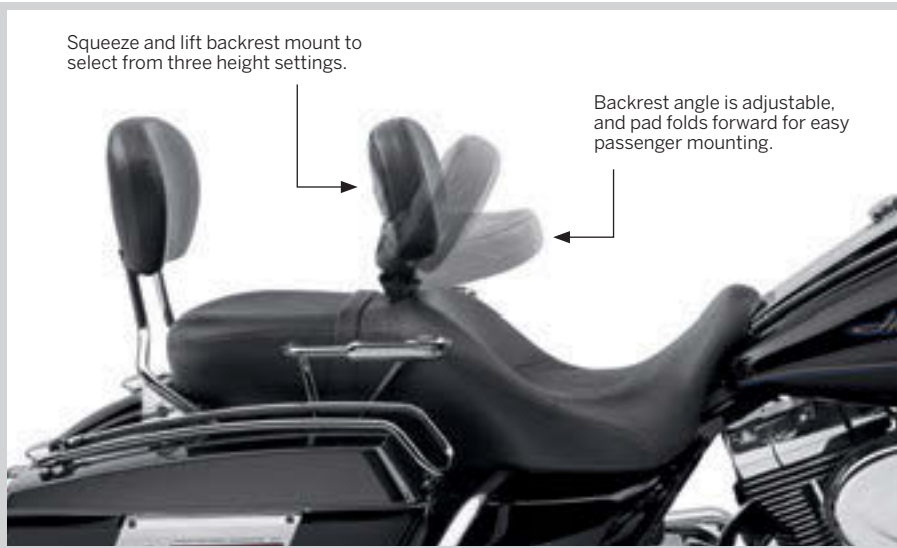

B. RIDER BACKREST

B. RIDER BACKRESTS

Add back support for long-haul riding comfort. Contoured backrest pad is shaped to provide full lower back support without pushing the rider forward and the slim profile offers the passenger a few more inches of room. An adjustable support bracket with four mounting locations accommodates different seats and riding positions. The backrest pad angle can be adjusted for maximum comfort.

Fits '88-later Touring and Trike models equipped with one-piece slotted seat. Installation requires separate purchase of model-specific Rider Backrest Mounting Kit.

1. 52572-09A	Comfort Stitch Style.	\$199.95
2. 52583-09A	Road King® Classic Style.	\$199.95
3. 51631-09A	'06-'10 Street Glide® Style.	\$199.95
4. 52900-09A	Smooth Leather Style.	\$219.95
5. 52914-09A	Smooth Vinyl Style.	\$199.95

Shown with:

RIDER BACKREST MOUNTING KIT

Kit includes mounting bracket and all required installation hardware.

52589-09A Required to install rider backrest on '09-later Touring models. Does not fit Trike models. **\$47.95**

52300642 Required to install rider backrest on '09-later Trike models. **\$47.95**

52587-09 Required to install rider backrest on '88-'08 Touring models. **\$47.95**

C. RIDER BACKREST ORGANIZER

Keep your passenger's essentials close at hand. Convenient storage system is form fitted to the rider backrest, and provides easy access to a variety of on-road necessities. The two zippered pockets and mesh pouch offer plenty of room for a water bottle, cell phone, keys, registration papers, sunscreen and lip balm, and one zippered pocket features a headphone port for easy connection to a personal music device. The Organizer features side laces for secure installation, and a smooth vinyl face with no raised seams for rider comfort.

93300098 Fits '09-later models equipped with H-D® Rider Backrest. **\$114.95**



B. RIDER BACKRESTS (SHOWN WITH MOUNTING KIT)



C. RIDER BACKREST ORGANIZER

Notice: The prices appearing in this catalog are the manufacturer's suggested retail prices. Actual retail prices may vary.

340 TOURING & TRIKE

Seating – Accessories

A. PASSENGER ARMRESTS

If your passenger is happy, you'll be happy. Premium passenger armrests have been ergonomically designed to provide the ultimate in passenger comfort. The soft pads provide excellent forearm support on a long ride and eliminate the passenger's "what do I do with my hands" dilemma. Both armrests conveniently swing out of the way for easy mounting and dismounting and the pads and arms can be oriented in multiple positions for increased comfort. The armrest pads feature spring-loaded hinged storage compartments that can easily hold your compact personal items. The high-quality black vinyl upholstered pads and support arms blend beautifully with Original Equipment seats and speaker pods. Complete kit includes all required installation hardware.

52400073 **\$389.95**

Fits '14-later Touring models equipped with Hard Tour-Pak® Luggage (except CVO™ models). Also fits with H-D® Detachables™ Tour-Pak Mounting Racks. Does not fit Trike models or vehicles with saddlebag lid rails or passenger grab rail.

52400106 **\$359.95**

Fits '09-later FLHTCUTG models. Not compatible with Boom!™ Audio Trike Body-Mount Speaker Kit P/N 76000618.



A. PASSENGER ARMRESTS (52400073 SHOWN)



A. PASSENGER ARMRESTS –
RETRACTED



A. PASSENGER ARMRESTS –
STORAGE COMPARTMENT



A. PASSENGER ARMRESTS
(52400073 SHOWN)

Notice: The prices appearing in this catalog are the manufacturer's suggested retail prices. Actual retail prices may vary.

TOURING & TRIKE 341

Seating – Accessories



B. PASSENGER GRAB RAIL – CHROME
(52400090 SHOWN)



B. PASSENGER GRAB RAIL – GLOSS BLACK
(52400091 SHOWN)

B. PASSENGER GRAB RAIL

Add comfort and confidence for your riding companion. This easy-to-install handrail provides a convenient hand grip for your passenger and a secure tie-down point for pillion-mounted touring luggage.

Fits '14-later Touring and Tri Glide® models. Does not fit models equipped with Tallboy® Seat P/N 52000134 or Passenger Armrest Kit P/N 52400073 or FLHTKSE and FLTRUSE models with Original Equipment seat.

52400090	Chrome.	\$129.95
52400091	Gloss Black.	\$129.95

Fits '09-'13 Touring models. Does not fit Trike or models equipped with Harley® Hammock or Tallboy Seats.

97026-09	Chrome.	\$129.95
-----------------	---------	-----------------

Fits '06-'08 Electra Glide®, Street Glide®, Road King® and Road Glide® and '10-'11 FLHXXX models. Does not fit Touring models with Tour-Pak® mounted rear speakers, or models equipped with Leather Saddlebags or Harley Hammock Seats. Original Equipment on '99-'05 FLHT, FLHTC and FLHTCU and '09-'13 FLHTCUTG models.

91583-99	Chrome.	\$129.95
-----------------	---------	-----------------

C. PASSENGER HANDRAIL COVERS

Beef up the look of the passenger handrail with these easy-to-install chrome-plated grips. The thick diameter offers a firm and comfortable hand hold for your passenger and features jet black rubber inserts, ball-milled grooves and Bar & Shield logo for added style. Kit includes right and left grip and stainless steel mounting hardware.

91668-05		\$64.95
Fits '99-'13 Touring models equipped with Passenger Grab Rails.		



B. PASSENGER GRAB RAIL
(97026-09 SHOWN)



C. PASSENGER HANDRAIL COVERS

D. QUICK-RELEASE SEAT HARDWARE KIT

This Quick-Release Hardware Kit allows the rider to remove one-piece Harley-Davidson® seats quickly and easily. The knurled knob is easy to install or remove without tools, and the nylon washer keeps the finger tightened knob in place and rattle free. A raised-logo Harley-Davidson emblem finishes the look. SAE 1/4"-20 thread.

Fits '97-later XG, XL, Dyna®, Softail® (except '12-'17 FLS models equipped with Original Equipment seat), Touring and Trike models equipped with SAE 1/4"-20 seat mount hardware. Does not fit seats equipped with spring-loaded rear seat bracket.

51676-97A	Chrome.	\$19.95
10500093	Gloss Black.	\$19.95



D. QUICK-RELEASE SEAT HARDWARE KIT – CHROME



D. QUICK-RELEASE SEAT HARDWARE KIT – GLOSS BLACK

Notice: The prices appearing in this catalog are the manufacturer's suggested retail prices. Actual retail prices may vary.

342 TOURING & TRIKE

Seating Accessories

A. ROAD ZEPPELIN® SEAT PAD

Experience ultimate comfort. Designed to ensure hours of comfort in the saddle, Road Zeppelin® Seat Pads are equipped with a unique air bladder system that allows your weight to be supported evenly across the entire seating surface. Whether you have a low profile seat or a larger more comfortable seat, you will feel the benefits. This air bladder system is designed to reduce pressure points, provide shock absorption, and reduce vibration. Unlike other mouth-inflated seat pads, the Road Zeppelin Pad features an easy-to-reach integrated hand pump and metered air release valve that permits quick and controllable adjustment. You can easily adjust the comfort and support while seated on the pad. The UV-stable and snag resistant mesh cover allows air to circulate beneath the rider's body, reducing the temperature trapped between the rider and seat. Shaped to conform to most Harley-Davidson® seats, the pads feature adjustable mounting straps and a non-skid surface to keep them in place. The hand-washable seat pad can be deflated and rolled for compact storage.

52000327 Rider. **\$169.95**

Fits rider position on all models equipped with Original Equipment or accessory seats. Also fits passenger position on Touring models with large pillion area. Pad width – 14.0".

52400162 Passenger. **\$149.95**

Fits Original Equipment and accessory passenger pillions. Pad length – 12.0"; width – 9.0".



A. ROAD ZEPPELIN SEAT PAD



A. ROAD ZEPPELIN SEAT PAD



A. ROAD ZEPPELIN SEAT PAD

Mesh cover permits air circulation to reduce temperature trapped between the rider and the seat.

12 air pockets are designed to reduce pressure points and spread the rider's weight across a wide surface.

Hand-washable seat pad can be deflated and rolled for compact storage.

Inner bladder pockets are interconnected to create a balanced air cushion for optimal support.

Non-skid bottom pad and adjustable mounting straps hold the pad in place.

Ergonomic design for easy hand grip while working the pump

Leak-free twist air release valve for quick and controllable adjustment.

Integrated bulb-style air pump for easy inflation.

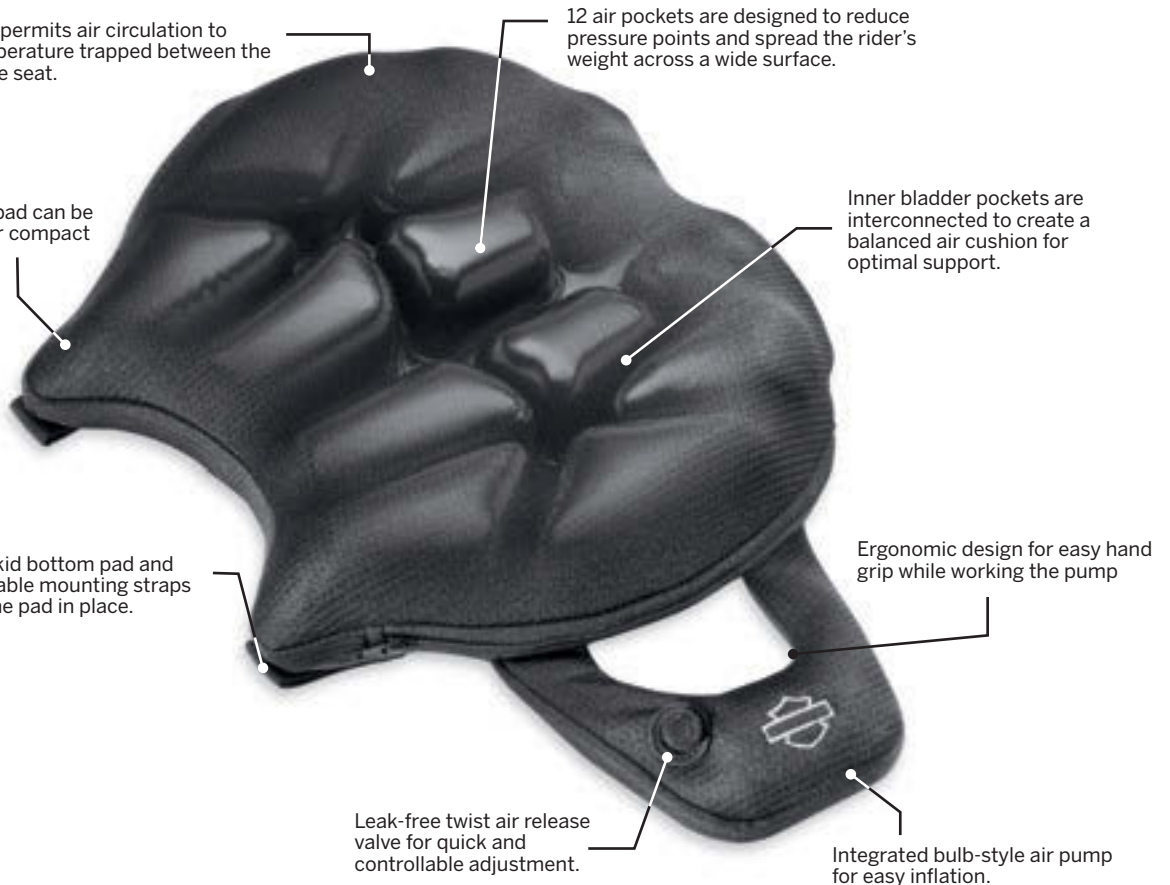

Notice: The prices appearing in this catalog are the manufacturer's suggested retail prices. Actual retail prices may vary.

TOURING & TRIKE 343

Seating Accessories



B. CIRCULATOR SEAT PADS (ROAD KING SHOWN)

B. CIRCULATOR SEAT AND BACKREST PADS

Keep comfortable on your next long ride. These breathable Circulator Seat and Backrest Pads feature 3-D construction that promotes air movement and reduces heat build-up where the rider's body touches the seat or backrest. Designed to keep the rider cool by reducing the perspiration build-up between you and the seating surface, the Circulator Pad can be installed and removed in seconds for easy cleaning. The low-profile design minimizes seat-height change compared to inflatable pads, while enhancing comfort with its shock-absorbing construction. Manufactured of UV-stable materials, these seat and backrest pads resist fading when exposed to the sun. Elastic under-seat strap and non-slip base provide secure installation and the available Circulator Passenger Pillion Pad attaches to the rider pad with hook-and-loop tabs.

51076-10 Large Seat Pad. **\$99.95**

Fits Softail®, Touring and Trike models with Original Equipment and accessory seats. Will not fit Bobber or Road Zeppelin® seats. 16.0" wide.

51078-10 Passenger Pillion Pad. **\$69.95**

Fits Original Equipment and accessory passenger pillions. 13.0" wide.

52300103 Wide Backrest Pad. **\$59.95**

Fits wide profile Rider and Passenger Backrest Pads up to 12.0" wide and 9.0" tall.

52300105 Tour-Pak® Wrap Around Backrest. **\$69.95**

Fits Tour-Pak Wrap Around Passenger Backrest Pads.



B. CIRCULATOR BACKREST PAD – WIDE



B. CIRCULATOR BACKREST PAD – WRAP AROUND

C. RAIN COVERS*

Featuring a handy storage sack, this black nylon, water-resistant, Cordura® cover packs easily and shelters your seat from the storm.

51638-97 Solo Seat. **\$29.95**

Fits H-D® solo seats (except XR and FLSTS).

52952-97 Seat with Rider Backrest. **\$39.95**

Fits H-D Touring and Trike seats. Fits with accessory rider backrest.

D. FLHT/FLTR TRIM PIECE

This top-stitched trim piece opens a new world to the Standard Electra Glide® and Road Glide® model owners, allowing fitment of Road King® seats.

52447-96 Fits '94-'07 FLHT and FLTR models. **\$29.95**



C. RAIN COVER – SEAT WITH RIDER BACKREST



D. FLHT/FLTR TRIM PIECE

! *WARNING: Do not use while riding; could result in death or serious injury.

Notice: The prices appearing in this catalog are the manufacturer's suggested retail prices. Actual retail prices may vary.

344 TOURING & TRIKE

Backrests & Racks

A. QUICK-RELEASE SISSY BAR UPRIGHT – FREEWHEELER® MODELS

Add passenger comfort and support to your Freewheeler® Trike model. Designed to blend with the curved lines of the trunk lid, the one piece upright slips into the docking ports and can be removed in seconds with a simple push of the release buttons. When the sissy bar is removed, you can pop in the included decorative caps for a clean custom look. The standard height upright accepts most mid-sized or oversized touring model passenger backrest pads (sold separately) and is the perfect finishing element for your long-distance touring machine. Available in your choice of mirror chrome or gloss black finish.

Fits '15-later FLRT models.

52300324A Chrome. **\$249.95**

52300415 Gloss Black. **\$249.95**

B. AIR WING LUGGAGE RACK – FREEWHEELER MODELS*

The low-profile aerodynamic styling of the Air Wing Luggage Rack draws your eye with its sleek lines and the engraved Harley-Davidson script adds a signature touch. This full-sized rack protects the trunk lid from scratches. The die-cast wing and lightweight steel tubing are hand-polished before finishing for long-lasting beauty. Kit includes all necessary mounting hardware.

50300097 Chrome. **\$199.95**

Fits '15-later FLRT models.



A. QUICK-RELEASE SISSY BAR UPRIGHT – FREEWHEELER MODELS
CHROME

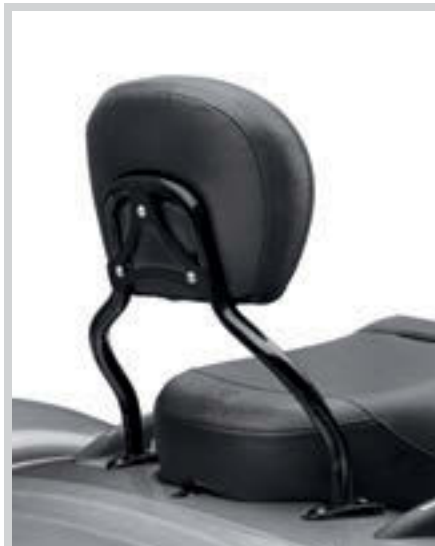

A. QUICK-RELEASE SISSY BAR UPRIGHT – FREEWHEELER MODELS
GLOSS BLACK



B. AIR WING LUGGAGE RACK – FREEWHEELER MODELS



***WARNING:** Do not use this rack as a seat. Do not exceed the fender rack weight capacity. Using as seat or exceeding this capacity could cause handling problems which could result in loss of control and death or serious injury.

Notice: The prices appearing in this catalog are the manufacturer's suggested retail prices. Actual retail prices may vary.

TOURING & TRIKE 345

Backrests & Racks

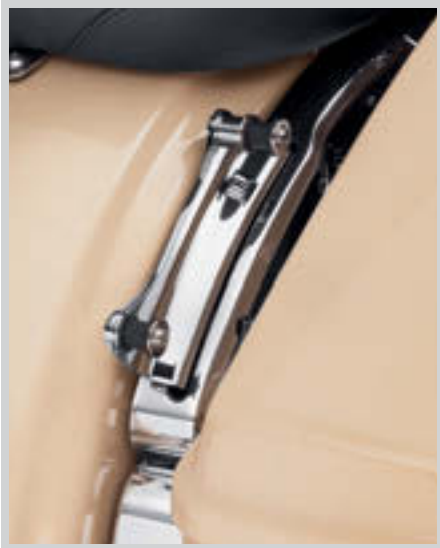

C. 4-POINT DOCKING HARDWARE KIT – CHROME
'14-LATER MODELS



C. 4-POINT DOCKING HARDWARE KIT – GLOSS BLACK
'14-LATER MODELS

C. 4-POINT DOCKING HARDWARE KIT

The ideal choice for maximum versatility, this complete kit contains the docking hardware necessary to install all H-D® Detachables™ accessory options. Even if you only install a passenger backrest today, this kit allows you to add additional accessories as your touring demands change. Provides docking points to allow installation of H-D Detachables Sissy Bar, Solo Luggage Rack, Two-Up Luggage Rack, Solo Tour-Pak® Rack or Two-Up Tour-Pak Rack.

Fits '14-later Touring models (except models equipped with rigid-mount Tour-Pak luggage).

52300353	Chrome.	\$164.95
52300354	Gloss Black.	\$164.95

Fits '09-'13 FLHR, FLHRC, FLHT, FLHX, FLHXSE, FLTR, FLTRX and FLTRXSE, '13 FLHRSE and '09 FLTRSE models. For use with H-D Detachables Sissy Bars, Solo Luggage Racks, 2-Up Luggage Racks, Solo Tour-Pak Rack and 2-Up Tour-Pak Rack. FLHRC models require separate purchase of Saddlebag Hinge Stop P/N 90580-09.

54205-09A	Chrome.	\$174.95
54246-09A	Gloss Black.	\$174.95

D. H-D® DETACHABLES™ DOCKING HARDWARE KITS – '97-'08 TOURING MODELS

For Sissy Bar, Solo Luggage Rack or Solo Tour-Pak®
Kit contains the docking hardware necessary to install H-D® Detachables™ accessories on your Road King®, Road Glide®, Street Glide® or Electra Glide® Standard model. Provides docking points to allow installation of detachable Passenger Backrest, Solo Luggage Rack or Solo Tour-Pak® Rack.

53803-06 **\$44.95**
Fits '97-'08 Touring models (except FLHTCUI and '07-'08 FLHRSE).

For Two-Up Tour-Pak or Two-Up Luggage Rack
Kit contains the docking hardware necessary to install H-D Detachables accessories on your Road King, Road Glide, Street Glide or Electra Glide Standard model. Provides docking points to allow installation of detachable Two-Up Luggage Rack or Two-Up Tour-Pak.

53804-06 **\$69.95**
Fits '97-'08 Touring models (except FLHTCUI and '07-'08 FLHRSE).

Docking Hardware Fitment Matrix – '97-'08 Models

Touring Detachable	Docking Kit	Diagram
Sissy Bar Upright P/N 52933-97C, 52805-97B, 52935-04A or 52723-06A	53803-06	3 & 4
Two-Up Luggage Rack P/N 53743-97	53804-06	1 & 2
Two-Up Tour-Pak Rack P/N 53276-04A	53804-06	1 & 2
Solo Luggage Rack P/N 53048-06	53803-06	3 & 4

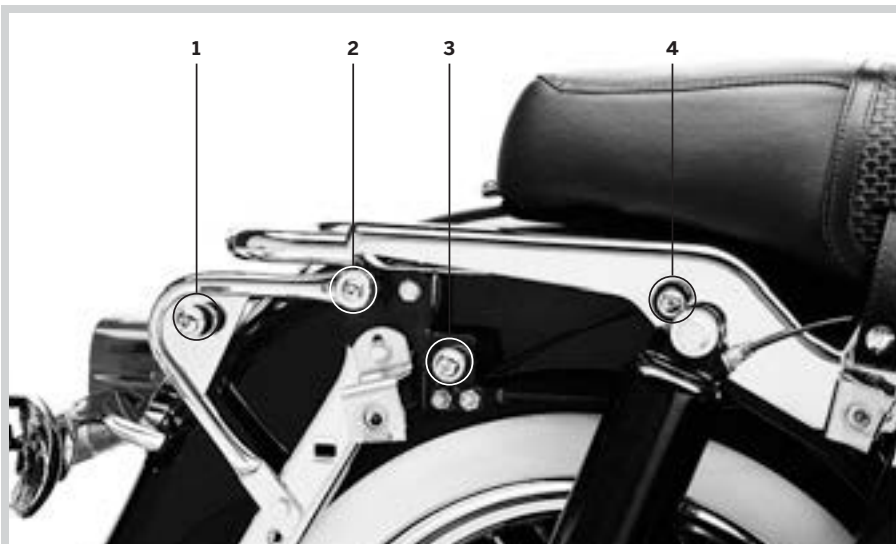

D. H-D DETACHABLES DOCKING HARDWARE KIT – '97-'08 TOURING MODELS



E. LOCKING H-D DETACHABLES LATCH KIT



F. H-D DETACHABLES LATCH KIT – CHROME

E. LOCKING H-D DETACHABLES LATCH KIT

This unique lock replaces the camlock on your H-D Detachables accessories, providing additional security and peace of mind when parking your vehicle. The kit includes two extended-reach barrel-style keys for easy access to the lock. Key registration and replacement service is available.

Fits all models equipped with detachable Sideplates, Racks and Tour-Pak Luggage Carriers (except '18-later Softail® models with HoldFast™ racks and uprights or '09-later Touring models equipped with detachable Solo Tour-Pak Rack).

90300087	Chrome.	\$79.95
90300086	Black.	\$74.95

F. H-D DETACHABLES LATCH KIT – CHROME

Decorative chrome latches are the perfect way to enhance the appearance of your detachable accessories. Meticulously polished and chrome-plated, these easy-to-install rotary latches are a direct replacement for the Original Equipment satin black parts and are a simple way to add a finishing touch to your ride. Latches feature an easy-to-pull finger release to simplify access in hard-to-reach areas.

12600036 **\$49.95**
Fits all models equipped with detachable Sideplates, One-Piece Sissy Bar Uprights, Racks, and Tour-Pak Luggage Mounting Racks (except '18-later Softail models with HoldFast racks and uprights).

Notice: The prices appearing in this catalog are the manufacturer's suggested retail prices. Actual retail prices may vary.

346 TOURING & TRIKE

Backrests & Racks

A. H-D® DETACHABLES™ Sissy Bar UPRIGHT

A sissy bar and passenger backrest pad is the starting point for building a complete touring machine. The backrest provides long-range comfort and support and adds a feeling of confidence and control for the passenger. Available in your choice of height, these H-D® Detachables™ One-Piece Uprights can be installed or removed in seconds to add versatility to your ride. A wide variety of Backrest Pads are available for separate purchase.

Fits '09-later Touring models equipped with required Docking Hardware Kits. '09-later Touring models equipped with rigid-mount Tour-Pak® luggage require purchase of appropriate H-D Detachables Tour-Pak Conversion Kit.

52610-09A	Short – Chrome.	\$199.95
54248-09A	Short – Gloss Black.	\$199.95
52627-09A	Standard-Height – Chrome.	\$199.95
54247-09A	Standard-Height – Gloss Black.	\$199.95

Fits '97-'08 Road King®, FLHT, FLHX and FLTR models equipped with required Docking Kits. Fits '06-'08 FLHTC models equipped with H-D Detachables Tour-Pak Rack Mounting Kit P/N 53303-07A and Docking Hardware Kit P/N 53803-06.

52933-97C	Standard-Height – Chrome.	\$199.95
52723-06A	Tall – Chrome.	\$199.95



A. H-D DETACHABLES Sissy Bar UPRIGHT – '09-LATER TOURING MODELS



A. SHORT H-D DETACHABLES Sissy Bar UPRIGHT – GLOSS BLACK



A. STANDARD-HEIGHT H-D DETACHABLES Sissy Bar UPRIGHT – CHROME

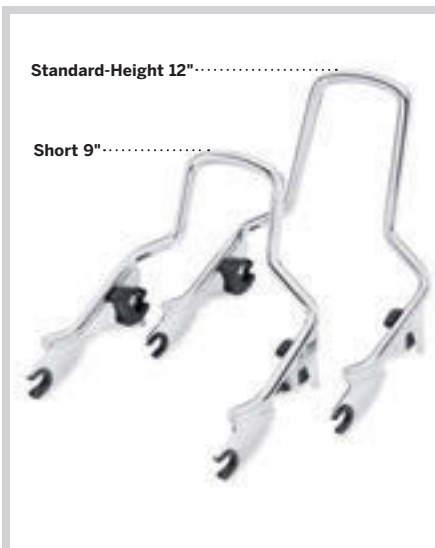

A. H-D DETACHABLES Sissy Bar UPRIGHT – '09-LATER MODELS



A. H-D DETACHABLES Sissy Bar UPRIGHT – '97-'08 MODELS

Notice: The prices appearing in this catalog are the manufacturer's suggested retail prices. Actual retail prices may vary.

TOURING & TRIKE 347

Backrests & Racks



B. PREMIUM H-D DETACHABLES BACKREST WITH ADJUSTABLE RECLINE



B. PREMIUM H-D® DETACHABLES™ BACKREST WITH ADJUSTABLE RECLINE

Enhance your passenger's ride with an adjustable passenger backrest. This adjustable backrest allows the passenger to change the recline angle for maximum comfort. Simply turn the glove-friendly locking knobs and adjust the upright to one of three different recline settings. The 3 position settings provide 16 degrees of adjustment, with the mid-position that matches a standard backrest recline. The exclusive cam lock H-D® Detachables™ design lets you add or remove the passenger backrest assembly in seconds. Available in chrome and gloss black finishes.

Fits '09-later Touring models equipped with required Docking Hardware Kits (except models equipped with Stealth Detach Luggage Rack). '09-later Touring models equipped with rigid-mount Tour-Pak® luggage require purchase of appropriate H-D Detachables Tour-Pak Conversion Kit.

52300257	Standard-Height – Chrome.	\$299.95
52300258	Standard-Height – Gloss Black.	\$299.95

C. AIR WING SISSY BAR UPRIGHT

Combine long-range comfort with an impressive dose of style. The Air Wing Sissy Bar Upright features a sleek tapered profile capped with a beautifully crafted billet airfoil casting. The detachable sissy bar is designed to be installed or removed in seconds, adding versatility to your ride. Finish the look with the matching Air Wing Sissy Bar Backrest Pad P/N 52300302 and complementing Air Wing Two-Up Luggage Rack. The bar can be equipped with optional LED Light Kit P/N 68000076 (Red) or 68000077 (Smoked) for added rear visibility.

Fits '09-later Touring models equipped with required Docking Hardware Kits (except models equipped with Stealth Detach Luggage Rack). '09-later Touring models equipped with rigid-mount Tour-Pak® luggage require purchase of appropriate H-D Detachables Tour-Pak Conversion Kit.

52300146	Chrome.	\$259.95
52300147	Gloss Black.	\$259.95

Also available: LED LIGHT KIT

This fast-acting LED Light Kit operates as a supplemental rear running light and brake light. The high, center-mount position places the light in the line-of-sight of following vehicles and the bright, fast-acting LED lamps get you noticed. Wiring is concealed inside the tubes for a clean, custom installation. Available with red or smoked lens.

Fits Air Foil Luggage Rack P/N 54290-11, 54291-11 and Air Wing Sissy Bar Upright P/N 52300146 and 52300147. Installation requires separate purchase of model-specific Wiring Harness Kit.

68000076	Red Lens.	\$49.95
68000077	Smoked Lens.	\$49.95

Also available: LED LIGHT KIT WIRING HARNESS

Required for installation of LED Light Kit on Air Wing Sissy Bar Upright P/N 52300146 or 52300147.

70641-08 **\$13.95**

Fits '09-'13 Touring models equipped with Air Wing Sissy Bar Upright P/N 52300146 or 52300147.

LED LIGHT KIT WIRING HARNESS

Required for installation of optional LED Light Kit on Luggage Racks and Passenger Backrests.

69200772 **\$17.95**

Fits '14-later Touring and Trike models equipped with Adjustable Luggage Rack P/N 50300044B or 50300076B, Air Wing Racks P/N 54283-09A, 50300008A, 79179-08 or 53000062 and Air Wing Passenger Backrests P/N 52300146 or 52300147.

Shown with:

AIR WING PASSENGER BACKREST PAD

Styled to complement available touring and custom seats, this pad is shaped to fit the contour of the Air Wing Sissy Bar Upright P/N 52300146 or 52300147.

52300302 **\$109.95**

Fits '09-later Touring models equipped with the Air Wing Sissy Bar Upright P/N 52300146 or 52300147.



B. PREMIUM H-D DETACHABLES BACKREST WITH ADJUSTABLE RECLINE – CHROME



B. PREMIUM H-D DETACHABLES BACKREST WITH ADJUSTABLE RECLINE – GLOSS BLACK

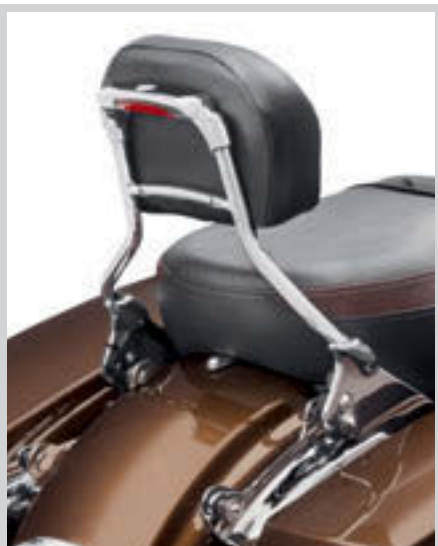

C. AIR WING SISSY BAR UPRIGHT – CHROME

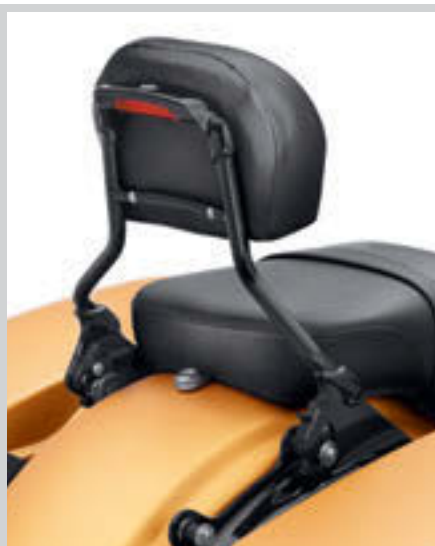

C. AIR WING SISSY BAR UPRIGHT – GLOSS BLACK

Notice: The prices appearing in this catalog are the manufacturer's suggested retail prices. Actual retail prices may vary.

TOURING

348 TOURING & TRIKE

Backrests & Racks

A. PASSENGER BACKREST PAD – COMPACT

Sized to complement low-profile custom seats, this Compact Passenger Backrest Pad combines practical passenger support with custom compact style. Pads include mounting bracket and hardware required for attachment to sissy bar upright.

Fits '18-later Softail® models equipped with Short or Standard Height HoldFast™ Sissy Bar Uprights. Also fits Touring models equipped with Short H-D® Detachables™ Passenger Sissy Bar Upright P/N 52935-04A, 52610-09A or 54248-09A. Will not fit seats with tall passenger pillion pads. Pad height 3.75"; width 6.5".

52300559	Smooth Black Vinyl.	\$64.95
52300558	Fat Bob Styling.	\$74.95
52300556	Fat Boy Styling.	\$74.95



**A. PASSENGER BACKREST PAD – COMPACT
(52300559 SHOWN)**

B. PASSENGER BACKREST PAD – MID-SIZED

Sized to fit both Low and Standard-Height HoldFast Sissy Bar Uprights, these Mid-Sized Backrest Pads feature a gentle curved shape that cradles the spine and provides hours of passenger comfort. Pad height 7.0"; width 6.5".

Fits '18-later Softail models equipped with Standard Height HoldFast Sissy Bar Uprights. Also fits Touring models equipped with Standard-Height H-D Detachables Passenger Sissy Bar Uprights P/N 52300324, 52627-09A, 54247-09A, 52933-97C or 52805-97B, Tall H-D Detachables Passenger Sissy Bar Upright P/N 52723-06A, Premium H-D Detachables Sissy Bar Upright 52300257 or 52300258.

52300560	Smooth Black Vinyl.	\$74.95
52300557	Low Rider Styling.	\$84.95



**A. COMPACT PASSENGER BACKREST PAD
(52300558 SHOWN)**

**A. COMPACT PASSENGER BACKREST PAD
(52300556 SHOWN)**

C. COMPACT PASSENGER BACKREST PAD

Sized to complement low-profile custom seats, this Compact Leather Backrest Pad combines practical passenger support with custom compact style. The leather cover with smooth insert complements both synthetic and leather seating surfaces.

52408-07A **\$199.95**
Fits Short H-D Detachables Passenger Sissy Bar Upright P/N 52935-04A. Also fits H-D Detachables Passenger Sissy Bar Upright P/N 52610-09A or 54248-09A with purchase of Billet Backrest Pad Mount P/N 53086-04 or Styled Backrest Pad Mount P/N 52825-05. Also fits '18-later Softail models equipped with Short or Standard Height HoldFast™ Sissy Bar Uprights. Will not fit seats with tall passenger pillion pads. Pad height 6.5"; width 10.5".



**B. PASSENGER BACKREST PAD – MID-SIZED
(52300560 SHOWN)**

**B. PASSENGER BACKREST PAD – MID SIZED
(52300557 SHOWN)**



C. COMPACT PASSENGER BACKREST PAD

Notice: The prices appearing in this catalog are the manufacturer's suggested retail prices. Actual retail prices may vary.

TOURING & TRIKE 349

Backrests & Racks



D. SHORT PASSENGER BACKREST PAD – SMOOTH LOOK



E. SHORT PASSENGER BACKREST PAD – MAHOGANY BROWN



F. SHORT PASSENGER BACKREST PAD – '18 CVO STYLING



F. SHORT PASSENGER BACKREST PAD – '19 CVO STYLING

NEW



G. SHORT PASSENGER BACKREST PAD – CVO ROAD GLIDE CUSTOM STYLING



H. SHORT PASSENGER BACKREST PAD – CVO STREET GLIDE CUSTOM STYLING



I. BILLET BACKREST PAD MOUNT

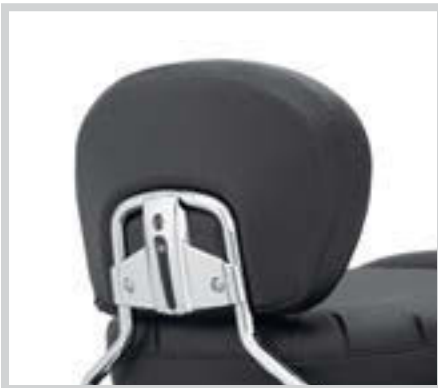

J. STYLED BACKREST PAD MOUNT

D. SHORT PASSENGER BACKREST PAD – SMOOTH LOOK

Smooth top-stitched pad complements most seating surfaces.

51579-05A \$109.95

Fits Short H-D® Detachables™ Passenger Sissy Bar Upright P/N 52935-04A, 52610-09A or 54248-09A. Also fits '18-later Softail® models equipped with Short or Standard Height HoldFast™ Sissy Bar Uprights. Will not fit seats with tall passenger pillion pads. Pad height 6.5"; width 10.5".

E. SHORT PASSENGER BACKREST PAD – MAHOGANY BROWN

Dressed in rich textured brown vinyl and finished with elegant gold stitching, this Short Passenger Backrest Pad is the perfect complement to the Mahogany Brown Seat and Pillion collection. Styled to match the '12 FLTRXSE model.

52300141A \$124.95

Fits Short H-D Detachables Passenger Sissy Bar Upright P/N 52935-04A, 52610-09A or 54248-09A. Will not fit seats with tall passenger pillion pads. Also fits '18-later Softail models equipped with Short or Standard Height HoldFast Sissy Bar Uprights. Pad height 6.5"; width 10.5".

F. SHORT PASSENGER BACKREST PAD – CVO™ STREET GLIDE® & CVO ROAD GLIDE® STYLING

Matches '18 or '19 CVO™ styling. Fits Short H-D Detachables Passenger Sissy Bar Upright P/N 52935-04A, 52610-09A or 54248-09A. Also fits '18-later Softail models equipped with Short or Standard Height HoldFast Sissy Bar Uprights. Will not fit seats with tall passenger pillion pads. Pad height 6.5"; width 10.5"

52300573 '19 CVO styling. \$129.95

52300566 '18 CVO styling. \$129.95

G. SHORT PASSENGER BACKREST PAD – CVO ROAD GLIDE® CUSTOM STYLING

Matches '13 CVO Road Glide® Original Equipment seat. (except the 110th Anniversary edition CVO '13 FLTRXSE).

52300300 \$129.95

Fits Short H-D Detachables Passenger Sissy Bar Upright P/N 52935-04A, 52610-09A or 54248-09A. Will not fit seats with tall passenger pillion pads. Also fits '18-later Softail models equipped with Short or Standard Height HoldFast Sissy Bar Uprights. Pad height 6.5"; width 10.5".

H. SHORT PASSENGER BACKREST PAD – CVO STREET GLIDE® CUSTOM STYLING

Matches '15 CVO Street Glide® Original Equipment seat.

52300361 \$129.95

Fits Short H-D Detachables Passenger Sissy Bar Upright P/N 52935-04A, 52610-09A or 54248-09A. Will not fit seats with tall passenger pillion pads. Also fits '18-later Softail models equipped with Short or Standard Height HoldFast Sissy Bar Uprights. Pad height 6.5"; width 10.5".

I. BILLET BACKREST PAD MOUNT

Chrome-plated billet aluminum and an engraved Bar & Shield emblem set the tone for this custom Passenger Backrest Mount, which will make you look even better as you're rolling by. Replaces the stock mounting plate and includes chrome-plated mounting hardware.

53086-04 \$69.95

Fits Touring models equipped with H-D Detachables Sissy Bar Upright P/N 52805-97B, 52933-97C, 52935-04A, 52723-06A, 52610-09A, 52627-09A, 52300257 or 52300258. Also fits '18-later Softail models equipped with HoldFast Sissy Bar Uprights (except if equipped with Compact Size Pad).

J. STYLED BACKREST PAD MOUNT

This custom Backrest Mounting Plate replaces the stamped metal mount for a distinctive look. The mirror-finished bracket, chrome-plated mounting hardware and Vivid Black insert contrasts with a leather or vinyl backrest pad to dress your Touring bike in style.

52825-05 \$49.95

Fits Touring models equipped with H-D Detachables Sissy Bar Upright P/N 52805-97B, 52933-97C, 52935-04A, 52723-06A, 52610-09A, 52627-09A, 52300257 or 52300258. Also fits '18-later Softail models equipped with HoldFast Sissy Bar Uprights (except if equipped with Compact Size Pad).

TOURING

Notice: The prices appearing in this catalog are the manufacturer's suggested retail prices. Actual retail prices may vary.

350 TOURING & TRIKE

Backrests & Racks

PASSENGER BACKREST PADS – MID-SIZED

Sized to fit Standard-Height and Tall Touring Sissy Bar Uprights. Available to match a wide variety of seat stitch designs, these Mid-Sized Backrest Pads feature a gentle curved shape that cradles the spine and provides hours of passenger comfort.

Fits Standard-Height H-D® Detachables™ Passenger Sissy Bar Uprights P/N 52300324, 52627-09A, 54247-09A, 52933-97C or 52805-97B, Tall H-D Detachables Passenger Sissy Bar Upright P/N 52723-06A, Premium H-D Detachables Sissy Bar Upright 52300257 or 52300258. Also fits '18-later Softail® models equipped with Short or Standard Height HoldFast™ Sissy Bar Uprights. Pad height 8.0"; width 12.0".

- A. MID-SIZED PASSENGER BACKREST PAD – LEATHER**
Styled to match Leather Low-Profile Bucket Seat P/N 52918-98A.
52920-98B **\$124.95**
- B. MID-SIZED PASSENGER BACKREST PAD – TOP-STITCHED**
Smooth top-stitched pad complements most seating surfaces.
52924-98B **\$119.95**
- C. MID-SIZED PASSENGER BACKREST PAD – COMFORT STITCH**
Styled to match Comfort Stitch Seats and Rider Backrests.
51272-05A **\$114.95**
- D. MID-SIZED PASSENGER BACKREST PAD – CUSTOM STITCHING**
Styled to match Road King® Custom models.
52657-04B **\$109.95**
- E. MID-SIZED PASSENGER BACKREST PAD – '06-'10 STREET GLIDE® STITCHING**
Styled to match the '06-'10 Street Glide® model.
51633-06A **\$109.95**



A. MID-SIZED PASSENGER BACKREST PAD – LEATHER



B. MID-SIZED PASSENGER BACKREST PAD – TOP-STITCHED



C. MID-SIZED PASSENGER BACKREST PAD – COMFORT STITCH

PASSENGER BACKREST PADS – OVERSIZED

Sized to fit Standard-Height and Tall Touring Sissy Bar Uprights. Available to match a wide variety of seat stitch designs, these Oversized Backrest Pads feature a large surface area and a generous curved shape that surrounds the passenger's lower back and provides added support for hours in the saddle.

Fits Standard-Height H-D Detachables Passenger Sissy Bar Uprights P/N 52300324, 52627-09A, 54247-09A, 52933-97C or 52805-97B, Tall H-D Detachables Passenger Sissy Bar Upright P/N 52723-06A, Premium H-D Detachables Sissy Bar Upright 52300257 or 52300258. Also fits '18-later Softail models equipped with Short or Standard Height HoldFast Sissy Bar Uprights. Pad height 9.5"; width 13.5".

- F. OVERSIZED PASSENGER BACKREST PAD – SMOOTH**
Smooth top-stitched pad complements most seating surfaces.
52886-98D **\$109.95**
- G. OVERSIZED PASSENGER BACKREST PAD – STUDDED**
Styled to match studded Original Equipment Road King® and Road King Touring Seat P/N 51617-99C.
52709-97C **\$109.95**



D. MID-SIZED PASSENGER BACKREST PAD – CUSTOM STITCHING



E. MID-SIZED PASSENGER BACKREST PAD – STREET GLIDE STITCHING



F. OVERSIZED PASSENGER BACKREST PAD – SMOOTH



G. OVERSIZED PASSENGER BACKREST PAD – STUDDED

Notice: The prices appearing in this catalog are the manufacturer's suggested retail prices. Actual retail prices may vary.

TOURING & TRIKE 351

Backrests & Racks



H. ADJUSTABLE TWO-UP LUGGAGE RACK – FINGERTIP CONTROL

H. ADJUSTABLE TWO-UP LUGGAGE RACK*

Expand your options at the push of a button. This stylish rack offers style, function and practicality in one. The Adjustable Two-Up Luggage Rack features telescoping side extensions that allow the rider to customize the rack's width in seconds. To accommodate a wide soft bag or duffel, just press the buttons, slide out the side extensions and increase the usable surface area by 50%. When an oversize rack is not required, just slide in the extensions for a clean look. The beefy rack accommodates a load capacity up to 30 pounds and the side rails feature convenient mounting points that easily accept bag tie-down straps and bungee cords. The H-D® Detachables™ rack can be completely removed from the bike in seconds and is designed to accept the internally-wired LED Light Kit P/N 68065-10 or 68219-10 (sold separately) for added visibility from the rear. Rack Dimensions: 12.0" D x 12.75" W (Unexpanded); 12.0" D x 18.75" W (Expanded).

Fits '09-later Touring models equipped with 4-Point Docking Hardware Kits (except '09-later CVO™ models with rigid-mount Tour-Pak® luggage). Models equipped with Original Equipment rigid-mount Tour-Pak require purchase of appropriate H-D Detachables Tour-Pak Rack Kit. FLHX, FLHXS, FLTR and FLTRX models require separate purchase of Antenna Relocation Kit or Hidden Antenna Kit. Some FLHRC EU registration plates may interfere with rack.

50300044B	Chrome.	\$399.95
50300076B	Gloss Black.	\$399.95

Also available:

LED LIGHT KIT

Fast-acting LED Light Kit operates as a supplemental rear running light and brake light. The high, center-mount position places the light in the line-of-sight of following vehicles and the bright, fast-acting red LED lamps get you noticed. Wiring is concealed inside the rack for a clean, custom installation. Available with red or smoked lens.

Fits '14-later Touring models equipped with Air Wing H-D Detachables Luggage Rack P/N 54283-09A and 50300008A and Adjustable Two-Up Luggage Rack P/N 50300076B. Does not fit CVO models.

68000111	Red Lens.	\$69.95
68000116	Smoked Lens.	\$69.95

Fits '09-'13 Touring (except CVO) models equipped with Air Wing H-D Detachables Luggage Rack P/N 54283-09A and 50300008A and Adjustable Two-Up Luggage Rack P/N 50300044B and 50300076B.

68065-10	Smoked Lens.	\$69.95
68219-10	Red Lens.	\$69.95



H. ADJUSTABLE TWO-UP LUGGAGE RACK – CHROME (CLOSED)



H. ADJUSTABLE TWO-UP LUGGAGE RACK – CHROME (OPEN)

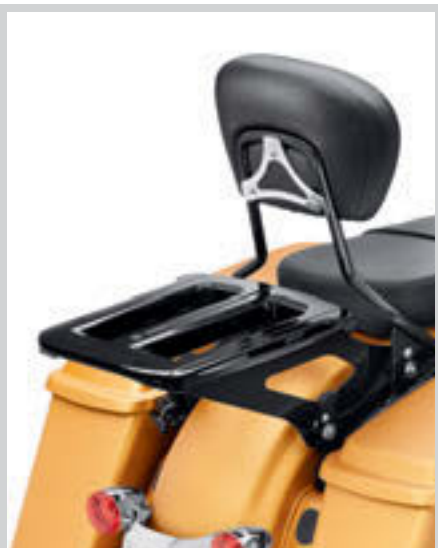

H. ADJUSTABLE TWO-UP LUGGAGE RACK – GLOSS BLACK (CLOSED)



H. ADJUSTABLE TWO-UP LUGGAGE RACK – GLOSS BLACK (OPEN)

***WARNING:** Do not use this rack as a seat. Do not exceed the fender rack weight capacity. Using as seat or exceeding this capacity could cause handling problems which could result in loss of control and death or serious injury.

Notice: The prices appearing in this catalog are the manufacturer's suggested retail prices. Actual retail prices may vary.

352 TOURING & TRIKE

Backrests & Racks

A. AIR WING H-D® DETACHABLES™ TWO-UP LUGGAGE RACK*

The low-profile aerodynamic styling defines the look of this Luggage Rack. Designed to work with or without H-D® Detachables™ Passenger Backrests, this rack can be installed or removed from the Docking Hardware in seconds, creating a truly versatile ride. Available in mirror chrome or rich gloss black finish, the rack draws your eye with its sleek lines and the engraved Harley-Davidson script adds a signature touch. The die-cast wing and lightweight steel tubing are hand-polished before finishing for long-lasting beauty. The rack is designed to incorporate the internal wiring of the Air Wing Rack Light Kit (sold separately) for a clean look.

Fits '09-later Touring models equipped with 4-point Docking Hardware Kits. '09-later Touring models equipped with rigid-mount Tour-Pak® luggage require purchase of appropriate H-D Detachables Tour-Pak Conversion Kit. FLHX, FLHXS, FLTR and FLTRX models require separate purchase of Antenna Relocation Kit or Hidden Antenna Kit. Some FLHRC EU registration plates may interfere with rack.

54283-09A	Chrome.	\$254.95
50300008A	Gloss Black.	\$254.95



A. AIR WING H-D DETACHABLES TWO-UP LUGGAGE RACK – CHROME

B. LED LIGHT KIT**

Fast-acting LED Light Kit operates as a supplemental rear running light and brake light. The high, center-mount position places the light in the line-of-sight of following vehicles and the bright, fast-acting red LED lamps get you noticed. Wiring is concealed inside the rack for a clean, custom installation. Available with red or smoked lens.

Fits '14-later Touring models equipped with Air Wing H-D Detachables Luggage Rack P/N 54283-09A and 50300008A and Adjustable Two-Up Luggage Rack P/N 50300044B or 50300076B. Does not fit CVO™ models.

68000111	Red Lens.	\$69.95
68000116	Smoked Lens.	\$69.95

Fits '09-'13 Touring (except CVO) models equipped with Air Wing H-D Detachables Luggage Rack P/N 54283-09A and 50300008A and Adjustable Two-Up Luggage Rack P/N 50300044B and 50300076B.

68065-10	Smoked Lens.	\$69.95
68219-10	Red Lens.	\$69.95



A. AIR WING H-D DETACHABLES TWO-UP LUGGAGE RACK – GLOSS BLACK



A. AIR WING LUGGAGE RACK (SHOWN WITH LED LIGHT KIT)



B. LED LIGHT KIT



***WARNING:** Do not use this rack as a seat. Do not exceed the fender rack weight capacity. Using as seat or exceeding this capacity could cause handling problems which could result in loss of control and death or serious injury.



****WARNING:** Disconnecting your DOT required tail, brake and turn signal lighting could reduce your visibility to others and result in death or serious injury.

Notice: The prices appearing in this catalog are the manufacturer's suggested retail prices. Actual retail prices may vary.

TOURING & TRIKE 353

Backrests & Racks



C. KING H-D DETACHABLES TWO-UP LUGGAGE RACK – CHROME



C. KING H-D DETACHABLES TWO-UP LUGGAGE RACK – GLOSS BLACK



D. STEALTH H-D DETACHABLES LUGGAGE RACK – CHROME



D. STEALTH H-D DETACHABLES LUGGAGE RACK – GLOSS BLACK



E. H-D DETACHABLES TWO-UP LUGGAGE RACK – CHROME



E. H-D DETACHABLES TWO-UP LUGGAGE RACK – GLOSS BLACK

C. KING H-D® DETACHABLES™ TWO-UP LUGGAGE RACK*

This stylish oversized King Two-Up Luggage Rack adds extra capacity for your cross-town or cross-country ride. The classic harp-shaped rack is constructed of large diameter steel rod, welded and perfectly polished for an elegant look. This rack is first in class with an increased load capacity up to 30 pounds. The large rack with side extensions offers a versatile flat load surface and the slotted side plates provide options for securing soft or rigid carrying bags. Designed to work with or without a H-D® Detachables™ Passenger Backrest, the rack can be installed or removed from the bike in seconds.

Fits '09-later Touring models equipped with 4-point Docking Hardware Kits. '09-later Touring models equipped with rigid-mount Tour-Pak® luggage require purchase of appropriate H-D Detachables Tour-Pak Conversion Kit. FLHX, FLHXS, FLTR and FLTRX models require separate purchase of Antenna Relocation Kit or Hidden Antenna Kit. Some FLHRC EU registration plates may interfere with rack.

50300054A	Chrome.	\$244.95
50300058A	Gloss Black.	\$244.95

D. STEALTH H-D DETACHABLES TWO-UP LUGGAGE RACK*

Style and practicality in one. This classic four-bar H-D Detachables Luggage Rack flows with the long and lean lines of today's custom rides. The rails and curving support blend together for an integrated floating look and the "stealth" hidden hardware adds to the clean design.

Fits '09-later Touring models equipped with 4-point Docking Hardware Kits (except '09-later Touring models equipped with Premium H-D Detachables Backrest with Adjustable Recline P/N 523000257 and 523000258). '09-later Touring models equipped with rigid-mount Tour-Pak luggage require purchase of appropriate H-D Detachables Tour-Pak Conversion Kit. FLHX, FLHXS, FLTR and FLTRX models require separate purchase of Antenna Relocation Kit or Hidden Antenna Kit. Some FLHRC EU registration plates may interfere with rack.

53472-09A	Chrome.	\$324.95
53566-09A	Gloss Black.	\$324.95

E. H-D DETACHABLES TWO-UP LUGGAGE RACK*

Smooth sweeping curves and a brilliant chrome finish defines the look of this Luggage Rack. Available in chrome or gloss black finish, this sleek and functional rack is an elegant solution for carrying your luggage across the country. Designed to work with or without H-D Detachables Passenger Backrests, this rack can be installed or removed from the Docking Hardware in seconds, creating a truly versatile ride.

Fits '09-later Touring models equipped with 4-point Docking Hardware Kits. '09-later Touring models equipped with rigid-mount Tour-Pak luggage require purchase of appropriate H-D Detachables Tour-Pak Conversion Kit. FLHX, FLHXS, FLTR and FLTRX models require separate purchase of Antenna Relocation Kit or Hidden Antenna Kit. Some FLHRC EU registration plates may interfere with rack.

54215-09A	Chrome.	\$224.95
50300042A	Gloss Black.	\$224.95



***WARNING:** Do not use this rack as a seat. Do not exceed the fender rack weight capacity. Using as seat or exceeding this capacity could cause handling problems which could result in loss of control and death or serious injury.

Notice: The prices appearing in this catalog are the manufacturer's suggested retail prices. Actual retail prices may vary.

354 TOURING & TRIKE

Backrests & Racks

A. LUGGAGE RACK FOR H-D® DETACHABLES™ PASSENGER SISSY BAR UPRIGHT*

This attractive chrome-plated rack adds additional versatility to your H-D® Detachables™ Passenger Backrest. Designed to mount directly to the backrest upright, the rack and backrest can be easily removed or reinstalled as a unit to suit your touring or cruising style.

53011-98 **\$219.95**

Fits '94-'08 Touring models equipped with H-D Detachables Sissy Bar Upright P/N 52805-97B, 52933-97C and 52723-06A. (Does not fit P/N 52935-04A.) FLHRC and '07-'08 FLHRSE models also require separate purchase of Saddlebag Hinge Stop Kit P/N 90580-09.

B. H-D DETACHABLES TWO-UP LUGGAGE RACK*

Designed to work with H-D Detachables Backrests, these racks allow you to convert from a two-up traveler to a solo rider in classic style.

53743-97 **\$219.95**

Fits '97-'08 Road King®, FLHT, FLHX and FLTR models equipped with required Docking hardware. FLTR and FLHX models require separate purchase of Antenna Relocation Kit P/N 76208-07. Does not fit with Layback License Plate Mounting Kit P/N 53385-00. Some EU registration plates may interfere with rack.

C. H-D DETACHABLES SOLO LUGGAGE RACK*

Add touring capabilities to your solo seat-equipped model in less than 60 seconds. This H-D Detachables Solo Rack fits over the fender when the passenger pillion is removed. The rack features sweeping curved rails and the chrome finish adds a stylish flair. Easily interchangeable with H-D Detachables Passenger Sissy Bar Upright.

54213-09A **\$249.95**

Fits '09-later FLHR, FLHRC, FLHRXS, FLHT, FLHX, FLHXS, FLHXSE, FLTR, FLTRX, FLTRXSE, '13 FLHRSE and '09 FLTRSE models equipped with a solo seat. Requires separate purchase of a 2-Point or 4-Point Docking Hardware Kit.



A. LUGGAGE RACK FOR H-D DETACHABLES PASSENGER SISSY BAR UPRIGHT



B. H-D DETACHABLES TWO-UP LUGGAGE RACK



C. H-D DETACHABLES SOLO LUGGAGE RACK



***WARNING:** Do not use this rack as a seat. Do not exceed the fender rack weight capacity. Using as seat or exceeding this capacity could cause handling problems which could result in loss of control and death or serious injury.

Notice: The prices appearing in this catalog are the manufacturer's suggested retail prices. Actual retail prices may vary.

COLOR-MATCHED TOUR-PAK® LUGGAGE

When you're serious about racking up miles, Tour-Pak® luggage systems will help you pack for the trip. This Color-Matched hard luggage provides the capacity to pack for almost any riding condition. Carry the rain gear, clothing and camping equipment you need for a ride across the country or pack the groceries on a run to the corner store.

Tour-Pak luggage is available in primed finish or Color-Matched to many factory color combinations. Solid colors, solid colors with complementing pinstripes and two-tone finishes are available to match most late-model Harley-Davidson® color schemes. Tour-Pak luggage systems are available in three capacities. The Razor-Pak is sized to carry a briefcase, laptop computer or a change of clothes, the Chopped Tour-Pak luggage offers a low-profile shape, styled to complement a long and lean Touring bike and the King Tour-Pak luggage is sized to provide maximum storage space. Tour-Pak luggage can be installed on Touring models equipped with rigid or H-D® Detachables™ Tour-Pak Racks. Passenger backrest pads are available to complement Original Equipment or accessory seats.

KING TOUR-PAK LUGGAGE

'97-'13 MODELS

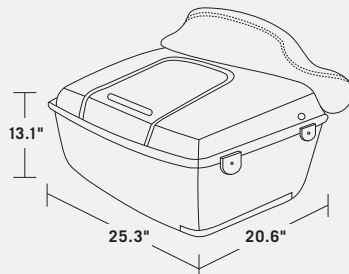

CAPACITY 4,260 CI

Add long-haul convenience and storage capacity to your Road King®, Street Glide® or Electra Glide® Standard model. Color-Matched to the motorcycle base color, this Tour-Pak luggage is factory drilled for wrap-around backrest (sold separately).

Tour-Pak includes hinges and latches, bottom reinforcement plate, luggage box mat, map pouch and chrome side accents. King Tour-Pak can be equipped with optional wrap-around LED rear and side light kits (sold separately).

KING TOUR-PAK LUGGAGE

'14-LATER MODELS

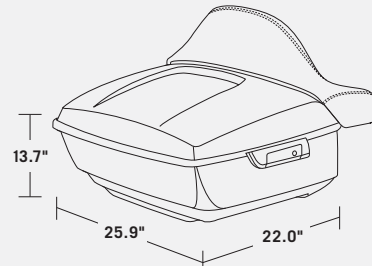

CAPACITY 4,290 CI

Turn your Touring model into a complete cross-country touring machine.

The color-matched King Tour-Pak luggage features a streamlined profile that complements the sleek design of the '14-later Rushmore models.

Tour-Pak is factory drilled for wrap-around backrest (sold separately) and equipped with chrome hinges, chrome one-touch latch, chrome side accents, luggage box mat and lid tether. Optional LED rear and side light kits are available.

CHOPPED TOUR-PAK LUGGAGE

'97-'13 MODELS

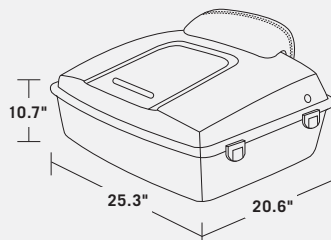

CAPACITY 3,285 CI

Achieve a radical touring profile with this 3.0" lower Tour-Pak luggage. The traditional Tour-Pak luggage shape has been chopped and sectioned for a sleek, sporty look, while maintaining the practical weather tight and secure storage that the long-distance rider demands. The Chopped Tour-Pak is completely assembled with factory hinges and latches and is pre-drilled for your choice of Chopped Tour-Pak backrest pads (sold separately).

CHOPPED TOUR-PAK LUGGAGE

'14-LATER MODELS

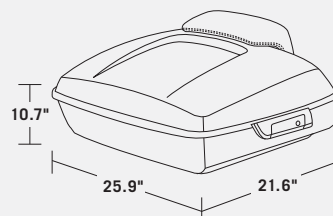

CAPACITY 3,285 CI

Get ready to travel in style. The slim profile of the Chopped Tour-Pak luggage is the perfect match for your radical custom bagger. But don't let the silhouette fool you – the Chopped Tour-Pak has loads of room to store all your gear. The Chopped

Tour-Pak is factory drilled for your choice of Chopped Tour-Pak backrest pads (sold separately), and equipped with chrome hinges, chrome one-touch latch, luggage box mat and lid tether.

356 TOURING & TRIKE

Tour-Pak® Accessories

A. RAZOR-PAK LUGGAGE

The ultimate in touring style. The slim but surprisingly roomy Razor-Pak Luggage is designed to add convenient luggage-carrying capacity without distracting from the lean look of your custom bagger. Ideal size to carry a briefcase, laptop computer or a change of clothes, the locking Razor-Pak top case can actually swallow compact half-helmets and some lightweight riding gear. So, get in a good day at the office, change your gear and hit Main Street in style. Razor-Pak Luggage can be mounted to rigid or H-D® Detachables™ Tour-Pak® mounting racks and accepts many of the lid racks, trim, spoilers and other accessories available for Chopped and King Tour-Pak Luggage. Capacity 1,900 cubic inches

Fits '97-'13 Touring and Trike models. FLHTCUTG models require addition of Spacer Kit P/N 83294-10. FLHXXX models require addition of Tour-Pak Rack Kit P/N 54144-10 and Spacer Kit P/N 83294-10.

79175-10DH Vivid Black. **\$799.95**

Shown with:

RAZOR-PAK BACKREST PAD – SMOOTH

Clean, smooth styling complements most seating surfaces.

79192-10 **\$149.95**

Fits '97-'13 models equipped with Razor-Pak luggage.



**A. COLOR-MATCHED RAZOR-PAK LUGGAGE
(SHOWN WITH H-D DETACHABLES TWO-UP TOUR-PAK RACK AND BACKREST PAD)**

B. TOUR-PAK® LUGGAGE

Add cross-country luggage capacity to your ride with accessory Tour-Pak® Luggage. A cavernous interior will hold one full-face helmet or two half helmets. Kit includes backrest pad, interior rubber mat, hardware and instructions. Luggage capacity: 2,500 cubic inches. Dimensions: 18.5" W x 17.0" D x 13.0" H. Racks and docking kits sold separately. International models may require separate purchase of License Plate Relocation Kit P/N 60095-00A.

Fits '04-later XL (except XL883N, XL1200C, XL1200CX, XL1200N and XL1200T) equipped with Solo Tour-Pak Rack, '00-'17 Softail® (except FLS, FLSS, FLSTNSE, FLSTSE, FXCW, FXCWC, FXS, FXSB, FXSBSE, FXSE, FXSTD and '09 FXSTSSE) equipped with H-D Detachables Solo or Two-Up Tour-Pak Rack and '97-'13 Touring models equipped with H-D Detachables Two-Up or Solo Tour-Pak Racks.

53147-98C **\$724.95**

Road King® Classic Leather Styling.

53690-06A **\$524.95**

Smooth Vinyl.



B. ROAD KING CLASSIC LEATHER TOUR-PAK LUGGAGE

C. LEATHER TOUR-PAK LOCK SET

Designed to discourage grab-and-run theft, this Lock Set provides a level of security that leather straps alone can't match. The complete kit includes external locking push-button latch release, locking mechanism, release cable, two keys, steel Tour-Pak lid mounting plate and all required installation hardware. Special order keyed-to-match lock sets are available for models with barrel-type keys. Contact your Dealer with your vehicle key code.

54360-05 **\$199.95**

Fits models equipped with Leather or Synthetic Leather Tour-Pak Luggage (except P/N 79189-06, 53000570, 53000598 or 53000599).



B. SMOOTH VINYL TOUR-PAK LUGGAGE



C. LEATHER TOUR-PAK LOCK SET

Notice: The prices appearing in this catalog are the manufacturer's suggested retail prices. Actual retail prices may vary.

TOURING & TRIKE 357

Tour-Pak® Accessories

NEW



D. CHOPPED TOUR-PAK BACKREST PAD – SMOOTH
'14-LATER MODELS



E. CHOPPED TOUR-PAK BACKREST PAD – '19 CVO STYLING



F. CHOPPED TOUR-PAK BACKREST PAD – '18 CVO STYLING



G. CHOPPED TOUR-PAK BACKREST PAD – '15 CVO STREET GLIDE STYLING



H. CHOPPED TOUR-PAK BACKREST PAD – '14 CVO ROAD KING STYLING



I. RAZOR-PAK BACKREST PAD – SMOOTH

CHOPPED TOUR-PAK® BACKREST PADS

Chopped Tour-Pak® Backrest Pads provide deep padded support for your passenger and a low-profile shape that complements the low, lean look of your Tour-Pak luggage. Easy to install, the floating design of the integrated mounts reduce the contact between the pad and the Tour-Pak carrier to minimize paint scuffing. Chopped Backrest Pads are available in a wide variety of styles to match most seating surfaces.

D. CHOPPED TOUR-PAK BACKREST PAD – SMOOTH

Clean, smooth styling complements most seating surfaces.

52300319 **\$174.95**

Fits '14-later Touring and Tri Glide® models equipped with Chopped Tour-Pak luggage.

52898-98A **\$174.95**

Fits '97-'13 Touring models equipped with Chopped Tour-Pak luggage.

E. CHOPPED TOUR-PAK BACKREST PAD – '19 CVO™ STYLING

Matches '19 CVO™ Original Equipment Seat.

52300572 **\$209.95**

Fits '14-later Touring and Tri Glide models equipped with Chopped Tour-Pak luggage.

F. CHOPPED TOUR-PAK BACKREST PAD – CVO STREET GLIDE® & CVO ROAD GLIDE® STYLING

Matches '18 CVO Street Glide® and Road Glide® Original Equipment seat.

52300567 **\$209.95**

Fits '14-later Touring models equipped with Chopped Tour-Pak luggage.

G. CHOPPED TOUR-PAK BACKREST PAD – CVO STREET GLIDE STYLING

Matches '15-'16 CVO Street Glide Original Equipment seat.

52300359 **\$209.95**

Fits '14-later Touring and Tri Glide models equipped with Chopped Tour-Pak luggage.

H. CHOPPED TOUR-PAK BACKREST PAD – CVO ROAD KING® STYLING

Matches '14 CVO Road King® Original Equipment seat with leather tuck and roll inlay.

52300335 **\$209.95**

Fits '14-later Touring and Tri Glide models equipped with Chopped Tour-Pak luggage.

I. RAZOR-PAK BACKREST PAD – SMOOTH

Clean, smooth styling complements most seating surfaces.

79192-10 **\$149.95**

Fits '97-'13 models equipped with Razor-Pak luggage.

TOURING

Notice: The prices appearing in this catalog are the manufacturer's suggested retail prices. Actual retail prices may vary.

358 TOURING & TRIKE

Tour-Pak® Accessories

KING TOUR-PAK® BACKREST PADS

Wrap-around King Tour-Pak® Backrest Pads are shaped to surround your passenger in comfort. The curved shape cradles the back and the integrated side wings fit naturally beneath your passenger's arms for added support. These backrests feature easy-to-install isolation mounts to reduce contact between the pad and the Tour-Pak luggage. King Backrest Pads are available in a variety of styles to match most seating surfaces.

A. SUN RAY® HEATED KING TOUR-PAK® BACKREST PAD

Take the chill out of cool spring days and brisk fall nights with a heated wrap-around backrest pad. The Sun Ray® Pad features a convenient high/low/off toggle control that directs two levels of soothing warmth right where you need it. This one-piece pad with integrated heat element and thermostatic control system is simple to install and the heating element is switched off with the ignition to avoid draining the battery. Available in Smooth or Comfort Stitch styles, this pad can be teamed with a Sun Ray or Harley® Hammock Heated Seat for the ultimate in back and bottom comfort.

52300317 Comfort Stitch. **\$349.95**
Fits '14-later Touring and Tri Glide® models equipped with King Tour-Pak® luggage. '14-'16 models require separate purchase of Electrical Harness Extension P/N 69200722. '17-later models require Electrical Harness Extension P/N 69201599A.



**A. SUN RAY HEATED KING TOUR-PAK BACKREST PAD – COMFORT STITCH
'14-LATER MODELS**

B. KING TOUR-PAK BACKREST PAD – COMFORT STITCH

Styled to match the Comfort Stitch Touring Seat series.

52300314 **\$249.95**
Fits '14-later Touring and Tri Glide models equipped with King Tour-Pak luggage.

52395-03B **\$249.95**
Fits '97-'13 Touring and Trike models equipped with King Tour-Pak luggage.



**B. KING TOUR-PAK BACKREST PAD –
COMFORT STITCH
'14-LATER MODELS**



**B. KING TOUR-PAK BACKREST PAD –
COMFORT STITCH
'97-'13 MODELS**

C. KING TOUR-PAK BACKREST PAD – SMOOTH

Clean, smooth styling complements most seating surfaces.

52300312 **\$229.95**
Fits '14-later Touring and Tri Glide models equipped with King Tour-Pak luggage.

52892-98B **\$229.95**
Fits '97-'13 Touring and Trike models equipped with King Tour-Pak luggage.



**C. KING TOUR-PAK BACKREST PAD –
SMOOTH
'14-LATER MODELS**



**C. KING TOUR-PAK BACKREST PAD –
SMOOTH
'97-'13 MODELS**

Notice: The prices appearing in this catalog are the manufacturer's suggested retail prices. Actual retail prices may vary.

NEW

TOURING & TRIKE 359

Tour-Pak® Accessories



D. KING TOUR-PAK BACKREST PAD – '19 CVO STYLING

D. KING TOUR-PAK® BACKREST PAD – '19 CVO™ STYLING

Matches '19 CVO™ Original Equipment Seat.

52300574 **\$349.95**

Fits '14-later Touring and Tri Glide® models equipped with King Tour-Pak® luggage.

E. KING TOUR-PAK BACKREST PAD – CVO STREET GLIDE® STYLING

Matches '15-'16 CVO Street Glide® Original Equipment seat.

52300360 **\$324.95**

Fits '14-later Touring and Tri Glide models equipped with King Tour-Pak luggage.

F. KING TOUR-PAK BACKREST PAD – CVO ROAD KING® STYLING

Matches '14 CVO™ Road King® Original Equipment seat.

52300334 **\$324.95**

Fits '14-later Touring and Tri Glide models equipped with King Tour-Pak luggage.

G. KING TOUR-PAK BACKREST PAD – LEATHER ROAD ZEPPELIN® STYLING

Styled to match the tufted leather Road Zeppelin® seat.

52335-97A **\$309.95**

Fits '97-'13 Touring and Trike models equipped with King Tour-Pak luggage.

H. KING TOUR-PAK BACKREST PAD – '06-'10 STREET GLIDE STYLING

Styled to match the '06-'10 Street Glide Original Equipment or Sundowner™ seat.

51634-06A **\$249.95**

Fits '97-'13 Touring and Trike models equipped with King Tour-Pak luggage.



E. KING TOUR-PAK BACKREST PAD – '15 CVO STREET GLIDE STYLING



F. KING TOUR-PAK BACKREST PAD – '14 CVO ROAD KING STYLING



G. KING TOUR-PAK BACKREST PAD – LEATHER ROAD ZEPPELIN STYLING



H. KING TOUR-PAK BACKREST PAD – '06-'10 STREET GLIDE STYLING

Notice: The prices appearing in this catalog are the manufacturer's suggested retail prices. Actual retail prices may vary.

360 TOURING & TRIKE

Backrests & Racks

H-D® DETACHABLES™ TOUR-PAK® MOUNTING RACKS

Fully loaded, stripped down or anywhere in between, you can tailor your Harley-Davidson® Touring motorcycle to meet the demands of the highway. With H-D® Detachables™ docking hardware, you can transform your ride in the blink of an eye. Switch from a comfortable passenger backrest to load-hauling Tour-Pak® luggage in seconds. You can easily remove the Tour-Pak luggage for easy maneuverability around town and reinstall it for an epic ride across the country. It's your choice and Harley-Davidson provides the flexibility to do it your way.

A. H-D DETACHABLES SOLO TOUR-PAK MOUNTING RACK*

The Solo Tour-Pak Rack moves a Razor-Pak, Chopped or King Tour-Pak luggage forward to a comfortable back-supporting position. The rack is designed to position the Tour-Pak luggage for solo riding and is adjustable over a .75" range. Simply remove the Tour-Pak luggage from the convenient H-D® Detachables™ docking hardware, add a passenger pillion and the bike is ready for two-up riding. Tour-Pak, Backrest Pad and Docking Hardware sold separately.

53000225 Chrome. **\$219.95**

Fits '14-later Touring models equipped with a solo seat. All models require separate purchase of Docking Hardware Kit and Boom!™ Audio Hidden AM/FM/WB Antenna P/N 76000513. Vehicles with stock tour-pak require purchase of Tour-Pak Luggage Conversion Kit P/N 53000291A. Chopped Tour-Pak luggage requires separate purchase of Tour-Pak Spacer Kit P/N 53000461. Not for use with Three-Pocket Fairing Pouch P/N 93300054B if used with Docking Kit P/N 52300131. Does not work with Boom! Audio Stage II Tour-Pak Speaker Kit P/N 76000526A.

53260-09B Chrome. **\$219.95**

Fits '09-'13 FLHR, FLHRC, FLHT, FLHX, FLHXSE, FLTR, FLTRX and FLTRXSE, '13 FLHRSE and '09 FLTRSE models. Requires separate purchase of 2-Point or 4-Point Docking Hardware Kit. FLHX and FLTR models require separate purchase of Tour-Pak Antenna Relocation Kit P/N 76556-09. '13 FLHRSE, '10-'12 FLHXSE, '09 FLTRSE and '12-'13 FLTRXSE models require separate purchase of Hidden Antenna Kit P/N 76000266.



RACK INSTALLED



RACK REMOVED



A. H-D DETACHABLES SOLO TOUR-PAK MOUNTING RACK



A. H-D DETACHABLES SOLO TOUR-PAK MOUNTING RACK – '14-LATER MODELS



A. H-D DETACHABLES SOLO TOUR-PAK MOUNTING RACK – '09-'13 MODELS



***WARNING:** Do not use this rack as a seat. Do not exceed the fender rack weight capacity. Using as seat or exceeding this capacity could cause handling problems which could result in loss of control and death or serious injury.

Notice: The prices appearing in this catalog are the manufacturer's suggested retail prices. Actual retail prices may vary.

TOURING & TRIKE 361

Backrests & Racks



B. H-D DETACHABLES TWO-UP TOUR-PAK MOUNTING RACK – CHROME

B. H-D® DETACHABLES™ TWO-UP TOUR-PAK® MOUNTING RACK*

Change your riding style in less than 60 seconds. The ultimate in touring flexibility, this Tour-Pak® Rack makes the convenience and protection of a Razor-Pak, Chopped, King or Leather Tour-Pak Luggage System a simple on-and-off proposition. Simple turn latches mount the rack to the bike's docking points and allow you to replace the Tour-Pak luggage with a detachable sissy bar upright for around-town cruising. The mounting rack positions a Tour-Pak behind the passenger pillion and allows the passenger to use the luggage as a supporting backrest. Adjustable over a .75" range, the Tour-Pak can be located for maximum passenger room and comfort. Tour-Pak, Passenger Backrest Pad and Docking Hardware Kit sold separately.

Fits '14-later FLHR, FLHRC, FLHRXS, FLHRSE, FLHX, FLHXS, FLHXSE, FLTRX and FLTRXS models. Requires separate purchase of Docking Hardware Kit. Street Glide® and Road Glide® models require Hidden AM/FM/WB Antenna P/N 76000513 or Antenna Relocation Kit P/N 76000582. Does not work with Boom!™ Audio Stage II Tour-Pak Speaker Kit P/N 76000526A.

53000221	Chrome.	\$209.95
53000459	Gloss Black.	\$209.95

Fits '09-'13 FLHR, FLHRC, FLHT, FLHX, FLHXSE, FLTR, FLTRX and FLTRXSE and '09 FLTRSE models. Requires separate purchase of 2-Point or 4-Point Docking Hardware Kit. FLHX and FLTR models require separate purchase of Hidden Antenna Kit P/N 76000266. '10-'12 FLHXSE, '09 FLTRSE and '12-'13 FLTRXSE models require separate purchase of Hidden Antenna Kit P/N 76000266.

53276-09B	Chrome.	\$209.95
------------------	---------	-----------------

Fits '97-'08 Road King®, FLHT, FLHX and FLTR models equipped with required docking hardware. FLTR and FLHX models require Antenna Relocation Kit P/N 76326-00A. Does not fit with Layback License Plate Mounting Kit P/N 53385-00. Some EU registration plates may interfere with Tour-Pak Rack. Models with rear fender tip trim can be adapted with the separate purchase of License Plate Relocation Kit P/N 60095-00A.

53276-04A	Chrome.	\$209.95
------------------	---------	-----------------



B. H-D DETACHABLES TWO-UP TOUR-PAK MOUNTING RACK – GLOSS BLACK



B. H-D DETACHABLES TWO-UP TOUR-PAK MOUNTING RACK – '14-LATER MODELS



B. H-D DETACHABLES TWO-UP TOUR-PAK MOUNTING RACK – '97-'08 MODELS



B. H-D DETACHABLES TWO-UP TOUR-PAK MOUNTING RACK – '09-'13 MODELS

***WARNING:** Do not use this rack as a seat. Do not exceed the fender rack weight capacity. Using as seat or exceeding this capacity could cause handling problems which could result in loss of control and death or serious injury.

Notice: The prices appearing in this catalog are the manufacturer's suggested retail prices. Actual retail prices may vary.

362 TOURING & TRIKE

Backrests & Racks

A. H-D® DETACHABLES™ TOUR-PAK® LUGGAGE CONVERSION KIT^{1,2} – '14-LATER

Transform your Electra Glide® model for around-town cruising. This kit includes everything needed to convert the rigid-mount Tour-Pak® luggage to an easy on-and-off detachable version. Complete kit includes Docking Hardware Kit, H-D® Detachables™ Two-Up Tour-Pak Mounting Rack, AM/FM Antenna Relocation Kit, License Plate Relocation Kit and Red Lens Electra Glo™ LED Saddlebag Run/Turn/Tail Lamp Kit.

Fits '14-later FLHTCU, FLHTCUL, FLHTK, FLHTKL, FLHTKSE, FLTRU and FLTRUSE models. Models equipped with CB require separate purchase of CB Antenna Relocation Kit P/N 76000308. CVO™ models separate purchase of Lighting Module P/N 69200949. Does not fit models equipped with Boom!™ Audio Stage II Tour-Pak Speaker Kits. Not compatible with Air Wing or Stealth Detachable Luggage Racks.

53000291A	Chrome.	\$574.95
53000567	Gloss Black.	\$574.95

Also available:

CB ANTENNA RELOCATION KIT

Relocates your CB antenna to the rear fender to accommodate use with a H-D Detachables Two-Up Tour-Pak Luggage Mounting Rack. Kit includes mounting bracket, all mounting hardware and wiring harness.

76000308 **\$74.95**
Fits '14-later FLHTCU, FLHTCUL, FLHTK, FLHTKL, FLHTKSE, FLTRU and FLTRUSE models equipped with Detachable Tour-Pak Conversion Kit P/N 53000291A.

B. H-D DETACHABLES TOUR-PAK LUGGAGE CONVERSION KIT¹ – '97-'13

Transform your Electra Glide model for around-town cruising. This kit includes everything needed to convert the rigid-mount Tour-Pak to an easy on-and-off detachable version. Complete kit includes two-up docking hardware kit, H-D Detachables Two-Up Tour-Pak Rack, chrome license plate holder, reflector and AM/FM antenna relocation hardware.

53246-09C **\$554.95**
Fits '09-'13 FLHTC, FLHTCU, FLHTK and FLTRU models. FLHTCU and FLHTK require separate purchase of Wiring Harness P/N 70032-09. FLTRU models require separate purchase of Wiring Harness P/N 69200181.

53303-07A **\$339.95**
Fits '97-'08 FLHTC models. '97-'05 models require separate purchase of Light Harness Kit P/N 70113-08.

Also available:

TOUR-PAK QUICK DISCONNECT HARNESS FOR ULTRA MODELS

Wiring Harness Kit allows the installation of Detachable Tour-Pak Rack Kit on specified models.

70032-09 **\$89.95**
Fits '09-'13 FLHTCU and FLHTK models equipped with Detachable Tour-Pak Rack Kit P/N 53246-09A.

69200181 **\$99.95**
Fits '11-'13 FLTRU models equipped with Detachable Tour-Pak Rack Kit P/N 53246-09A.

70113-08 **\$14.95**
Fits '97-'05 FLHTC models equipped with Detachable Tour-Pak Kit P/N 53303-07A.



A. H-D DETACHABLES TOUR-PAK LUGGAGE CONVERSION KIT – '14-LATER MODELS (TOUR-PAK REMOVED, PASSENGER BACKREST INSTALLED)



A. H-D DETACHABLES TOUR-PAK LUGGAGE CONVERSION KIT – '14-LATER MODELS CHROME

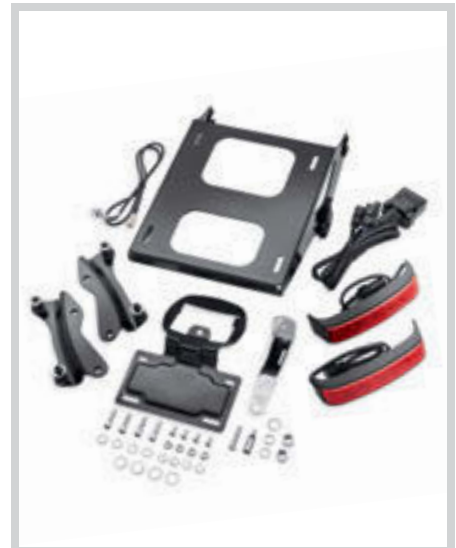

A. H-D DETACHABLES TOUR-PAK LUGGAGE CONVERSION KIT – '14-LATER MODELS GLOSS BLACK



B. H-D DETACHABLES TOUR-PAK CONVERSION KIT – '09-'13 MODELS



B. H-D DETACHABLES TOUR-PAK CONVERSION KIT – '97-'08 MODELS



¹ WARNING: Do not use this rack as a seat. Do not exceed the fender rack weight capacity. Using as seat or exceeding this capacity could cause handling problems which could result in loss of control and death or serious injury.



² WARNING: Disconnecting your DOT requirement brake lamp could reduce your visibility to others and result in death or serious injury.

Notice: The prices appearing in this catalog are the manufacturer's suggested retail prices. Actual retail prices may vary.

TOURING & TRIKE 363

Tour-Pak® Racks

C. AIR WING TOUR-PAK® LUGGAGE RACK*

The low-profile aerodynamic styling of the Air Wing Tour-Pak® Luggage Rack enhances the look of any Razor-Pak, Chopped or King Tour-Pak lid. Available in mirror chrome or rich gloss black finish, the rack draws your eye with its sleek lines and the engraved Harley-Davidson script adds a signature touch. This full-sized rack protects both Tour-Pak carrier's lid and passenger backrest from scratches. The die-cast wing and lightweight steel tubing are hand-polished before finishing for long-lasting beauty. Kit includes all necessary mounting hardware. For added visibility, the rack is designed to incorporate the internal wiring of the Air Wing Rack Light Kit P/N 68271-08 or 68250-08 (sold separately) for a clean look.

Fits King, Chopped and Razor-Pak Tour-Pak carrier lids. Mounting hole pattern matches Premium Tour-Pak Luggage Rack P/N 53665-87.

79179-08	Chrome.	\$199.95
53000063	Gloss Black.	\$199.95

D. AIR WING RACK LED LIGHT KIT

Custom fit to the Air Wing Tour-Pak Rack, this fast-acting LED Light Kit operates as a supplemental rear running light and brake light. The high, center-mount position places the rear light in the line-of-sight of following vehicles and the bright, fast-acting LED lamps get you noticed. Wiring is concealed inside the rack tubes for a clean, custom installation.

Fits '14-later Touring and Tri Glide® models equipped with Air Wing Tour-Pak Luggage Rack P/N 79179-08 or 53000063. Also fits '14-later FLHTKSE and '15-later FLTRUSE models with Original Equipment Tour-Pak Rack.

68000113	Smoked Lens.	\$69.95
68000112	Red Lens.	\$69.95

Fits '97-'13 Touring models equipped with Air Wing Tour-Pak Luggage Rack P/N 79179-08 or 53000063. Also fits '09-'13 FLHTCUSE models with Original Equipment Touring Rack.

68271-08A	Smoked Lens.	\$69.95
68250-08A	Red Lens.	\$69.95



C. AIR WING TOUR-PAK LUGGAGE RACK – CHROME



C. AIR WING TOUR-PAK LUGGAGE RACK – GLOSS BLACK



D. AIR WING RACK LED LIGHT KIT – SMOKED LENS



D. AIR WING RACK LED LIGHT KIT – RED LENS



***WARNING:** Do not use this rack as a seat. Do not exceed the fender rack weight capacity. Using as seat or exceeding this capacity could cause handling problems which could result in loss of control and death or serious injury.

Notice: The prices appearing in this catalog are the manufacturer's suggested retail prices. Actual retail prices may vary.

364 TOURING & TRIKE

Tour-Pak® Racks

A. STEALTH TOUR-PAK® LUGGAGE RACK*

Style and practicality in one. This classic six-bar Tour-Pak® luggage rack flows with the long and lean lines of today's custom rides. The cantilevered aerodynamic rails appear to float above the center spar, imparting a lighter-than-air profile. Hidden hardware adds to the clean design. The Stealth Rack mounts in the same position as the Original Equipment Ultra Limited rack or the accessory Premium and Air Wing Tour-Pak luggage racks, so no additional drilling is required on those models. Use Bungee Cord Soft-Hook Extensions P/N 52300140 to keep your luggage firmly in place.

Fits King, Chopped and Razor-Pak Tour-Pak carrier lids. Does not fit with Color-Matched Tour-Pak Spoiler kits.

53000242	Chrome.	\$239.95
53000247	Gloss Black.	\$239.95



A. STEALTH TOUR-PAK LUGGAGE RACK – CHROME



A. STEALTH TOUR-PAK LUGGAGE RACK – GLOSS BLACK

B. PREMIUM TOUR-PAK LUGGAGE RACK*

This full-sized rack is especially designed to complement Tour-Pak lids with armrest-style passenger backrests. Protects both Tour-Pak carrier's lid and passenger backrest from scratches. Lightweight steel tubing incorporates high-quality welded joints and is hand-polished and chrome-plated using copper as a base coat followed by nickel and chrome to provide long-lasting beauty. Comes complete with all necessary mounting hardware.

53665-87		\$139.95
-----------------	--	-----------------

Fits King, Chopped and Razor-Pak Tour-Pak carrier lids.

C. TOUR-PAK ACCENT RAIL – CHROME

Fabricated from highly polished steel tubing, these premium quality chrome-plated Accent Rails frame the wrap-around Tour-Pak carrier's lights for a custom look. The rails provide an added level of protection from pass-by contact. Kit includes all necessary mounting hardware.

53000229		\$134.95
-----------------	--	-----------------

Fits '14-later FLHTCU, FLHTCUL, FLHTK, FLHTKL, FLTRU, FLHTCUTG and models equipped with accessory King Tour-Pak and LED Wrap-Around Light. Does not fit CVO™ FLHTKSE or FLTRUSE models.



B. PREMIUM TOUR-PAK LUGGAGE RACK



C. TOUR-PAK ACCENT RAIL – CHROME

D. SADDLEBAG GUARD RAILS

Protect the sides and rear of your saddlebags from bumps and bruises. Saddlebag Guard Rails surround the lower portion of the bag, and add a traditional look to your Touring bike. The thick-walled chrome-plated tubing and the elegant cast mounts clamp securely to the Original Equipment saddlebag guards for a seamless look. The rails are pre-assembled to simplify installation, and the kit includes left and right rails and all required mounting hardware.

90200561		\$299.95
-----------------	--	-----------------

Fits '14-later Touring models (except FLHRC, FLHRSE, FLHRXS, FLHX, FLHXS, FLHXSE, FLTRX and FLTRXS). FLHTKSE models require separate purchase of Slotted Saddlebag Filler Strips.



D. SADDLEBAG GUARD RAILS – '14-LATER MODELS

E. TWIN RAIL CHROME SADDLEBAG GUARD KIT

Kit comes with rear saddlebag guards, side rails, mounting hardware and instructions for easy installation.

90892-09		\$349.95
-----------------	--	-----------------

Fits '09-'13 FLHR, FLHT, FLHTK, FLTR and FLTRU models. Stock on '09-'13 FLHTC and FLHTCU models. FLTR and FLTRU models require separate purchase of Saddlebag Supports P/N 49194-09A, 90781-09A, Nut P/N 7531 (Qty 2) and Antenna Mounting Bracket P/N 76516-09.

91216-97		\$349.95
-----------------	--	-----------------

Fits '97-'08 FLHR, FLHT, '06-'08 FLHTCUSE and '98-'08 FLTR models. '04-'08 FLTR models require the separate purchase of Saddlebag Supports P/N 49194-85 and 90781-93, Nut P/N 7686 (Qty 2) and Screw P/N 3601 (Qty 2).



E. TWIN RAIL CHROME SADDLEBAG GUARD KIT – '09-'13 MODELS



***WARNING:** Do not use this rack as a seat. Do not exceed the fender rack weight capacity. Using as seat or exceeding this capacity could cause handling problems which could result in loss of control and death or serious injury.

Notice: The prices appearing in this catalog are the manufacturer's suggested retail prices. Actual retail prices may vary.

TOURING & TRIKE 365

Saddlebag Lid Rails



F. TOURING SADDLEBAG LID RAILS – CHROME



G. AIR WING SADDLEBAG LID RAIL KIT – CHROME



G. AIR WING SADDLEBAG LID RAIL KIT – GLOSS BLACK



H. AIR WING FENDER RAIL FOR TRIKE – CHROME



I. AIR WING RAIL LED LIGHT KIT



F. TOURING SADDLEBAG LID RAILS

Protect your saddlebag lids from scratches and boot marks. Elegant welded rails are formed of high-quality tubing, and are beautifully polished and chrome plated to a mirror-like finish. The rails are shaped to wrap down the front of the saddlebag lid, and are designed to accept model-specific medallions (sold separately) for a custom touch. The three-point mount simplifies installation, and the complete kit includes left and right rails, and mounting hardware.

90200876 Chrome. **\$139.95**

Fits '14-later Touring models with Color-Matched Hard Saddlebags. Does not fit FLHXSE or models with saddlebag lid speakers or Passenger Armrest Kit P/N 52400073.

90200737 Chrome. **\$129.95**

Fits '93-'13 Touring models with Color-Matched Hard Saddlebags. Does not fit models with leather covered bags or models equipped with Saddlebag Wing Tips P/N 53826-00B or models equipped with Saddlebag Speaker Kit P/N 76000202.

G. AIR WING SADDLEBAG LID RAIL KIT

The low-profile aerodynamic styling of the Air Wing Saddlebag Lid Rail enhances the look and protects the lid of your Color-Matched Hard Saddlebags. Available in mirror chrome or gloss black finish, the rails cascade down the front of the saddlebag to protect the paint from a misplaced boot heel, and the die-cast wing design at the rear complements the style of the Air Wing Luggage Rack. Kit includes all necessary mounting hardware. For added visibility, add the available Air Wing Light Kit (sold separately).

Fits '14-later Touring models with Color-Matched Hard Saddlebags. Does not fit FLHXSE or models with saddlebag lid speakers or Passenger Armrest Kit P/N 52400073.

90200792 Chrome. **\$149.95**

90200793 Gloss Black. **\$149.95**

Fits '93-'13 Touring models with Color-Matched Hard Saddlebags. Does not fit models with leather covered bags or models equipped with Saddlebag Wing Tips P/N 53826-00B or models equipped with Saddlebag Speaker Kit P/N 76000202.

88299-09 Chrome. **\$139.95**

H. AIR WING FENDER RAIL FOR TRIKE – CHROME

The low-profile aerodynamic shape of the Air Wing Fender Rail enhances the look and protects the surface of your Trike's rear fenders. The mirror chrome rails follow the sleek contours of the fenders, and the slim rails and die-cast rear wings complement the available Air Wing Tour-Pak® Luggage Rack. Kit includes left and right rail and all necessary mounting hardware.

61400058 **\$169.95**

Fits '09-later FLHTCUTG and '10-'11 FLHXXX models. Does not fit with Trike Fender Bra P/N 57892-11.

I. AIR WING RAIL LED LIGHT KIT*

Custom fit to the Air Wing Rails, this fast-acting LED Light Kit operates as a supplemental rear running light and brake light. The high and outside mounting position places the lights in the line-of-sight of following vehicles, and the bright, fast-acting LED lamps get you noticed. Wiring is concealed inside the rack tubes for a clean, custom installation.

Fits '14-later Touring models equipped with Air Wing Saddlebag Rails P/N 90200792 or 90200793.

68000115 Red. **\$89.95**

68000114 Smoked. **\$89.95**

Fits '93-'13 Touring models equipped with the Air Wing Saddlebag Lid Rails P/N 88299-09, 90200391 and '09-'13 Trike models equipped with Air Wing Trike Fender Rails P/N 61400058.

68286-10 Smoked. **\$89.95**

68388-10 Red. **\$89.95**



***WARNING:** Disconnecting your DOT required tail, brake and turn signal lighting could reduce your visibility to others and result in death or serious injury.

Notice: The prices appearing in this catalog are the manufacturer's suggested retail prices. Actual retail prices may vary.

366 TOURING & TRIKE

Saddlebag Guards

A. SADDLEBAG SUPPORT KIT

Complete the stripped-down look by eliminating the rear saddlebag guards. This kit replaces the Original Equipment loop saddlebag guard and support with an inconspicuous bolt-on bar that supports the saddlebag for a clean, custom appearance. Kit includes left and right support and all necessary mounting hardware.

90200981 **\$99.95**

Fits '14-later FLHR, FLHTCU, FLHTCUL, FLHTK, FLHTKL, FLHTKSE and FLTRU models. Stock on '14-later FLHRSE, FLHRXS, FLHX, FLHXSE, FLTRUSE, FLTRX and FLTRXS models.

90881-09A **\$159.95**

Fits '09-'13 Touring models (except FLHRC and FLHTCUSE). Stock on '09-'13 FLHX, FLHXSE, FLTR, FLTRU, FLTRX, FLTRXSE, '13 FLHRSE and '09 FLTRSE models. Does not fit with Saddlebag Filler Strip Kits.

46565-04 **\$159.95**

Fits '97-'08 Touring (except FLHRC) models. Stock on FLHRS, FLHX and '04-'08 FLTR models.



A. SADDLEBAG SUPPORT KIT ('14-LATER MODELS)

B. REAR SADDLEBAG GUARD AND SUPPORT KIT*

Add protection and style to your ride. Complete kit replaces the under-saddlebag support found on some Touring models with loop-style saddlebag guards for a traditional look. Featured as Original Equipment on many Touring models, these chrome-plated guards protect the leading edge of the saddlebag, and are shaped to accept Saddlebag Guard Bags (sold separately) for added storage. Kit includes saddlebag supports, left and right guards and all necessary mounting hardware.

90200787 Chrome. **\$239.95**

Fits '14-later FLHRSE, FLHRXS, FLHX, FLHXSE, FLTRUSE, FLTRX, FLTRXS and FLTRXSE models. Stock on '14-later FLHR, FLHRC, FLHTCU, FLHTCUL, FLHTK, FLHTKL, FLHTKSE and FLTRU models.

90200788 Gloss Black. **\$239.95**

Fits '14-later FLHRSE, FLHRXS, FLHX, FLHXSE, FLTRU, FLTRUSE, FLTRX, FLTRXS and FLTRXSE models.

49282-09B Chrome. **\$249.95**

Fits '09-'13 FLHX, FLHXSE, FLTR, FLTRU, FLTRX, FLTRXSE, '13 FLHRSE and '09 FLTRSE models.

49291-07 Chrome. **\$249.95**

Fits '04-'08 FLHRS, FLHX, FLTR and '05 FLHTCSE models.



A. SADDLEBAG SUPPORT KIT ('09-'13 MODELS)



B. REAR SADDLEBAG GUARD AND SUPPORT KIT – CHROME ('14-LATER MODELS)



B. REAR SADDLEBAG GUARD AND SUPPORT KIT – GLOSS BLACK '14-LATER MODELS



B. REAR SADDLEBAG GUARD AND SUPPORT KIT – CHROME '09-'13 MODELS



***WARNING:** These guards may provide limited leg and cosmetic vehicle protection under unique circumstances (fall over while stopped, very low speed slide). They are not made nor intended to provide protection from bodily injury in a collision with another vehicle or any other object.

Notice: The prices appearing in this catalog are the manufacturer's suggested retail prices. Actual retail prices may vary.

TOURING & TRIKE 367

Saddlebag Guards



C. REAR SADDLEBAG GUARDS – GLOSS BLACK ('14-LATER MODELS)



C. REAR SADDLEBAG GUARDS – GLOSS BLACK*

Add a sinister look to your ride. Designed to replace the Original Equipment chrome-plated guards featured on many Touring models, the blacked-out finish minimizes the look without a reduction in protection.

90200791 \$194.95

Fits '14-later FLHR, FLHRC, FLHTCU, FLHTCUL, FLHTK, FLHTKL, FLHTKSE and FLTRU models. Installation requires reuse of Original Equipment saddlebag supports.

49283-09 \$194.95

Fits '09-'13 Touring models. FLHX, FLTR, FLTRU, FLTRX, FLTRXSE, '13 FLHRSE, '10-'12 FLHXSE and '09 FLTRSE models require separate purchase of Saddlebag Supports P/N 49194-09A and 90781-09A, Nut P/N 7531 (Qty 2) and Antenna Mounting Bracket P/N 76516-09.

46548-03 \$194.95

Fits '97-'08 Touring models. ('04-'08 FLTR, FLHX and FLHRS models require the separate purchase of Saddlebag Supports P/N 49194-85 and 90781-93 and two P/N 3601 and 7686.)

D. COMFORT PROFILE REAR SADDLEBAG GUARD KIT*

The unique profile of these chrome-plated Rear Saddlebag Guards gives your passenger more leg room. A perfect replacement for the Original Equipment saddlebag guards.

49179-09 \$194.95

Fits '09-'13 Touring models (except FLHTC, FLHTCU and FLHTCUSE). '09-'13 FLHX, FLHXSE, FLTR, FLTRU, FLTRX and FLTRXSE, '13 FLHRSE and '09 FLTRSE models require separate purchase of Saddlebag Supports P/N 49194-09A and 90781-09A, Nut P/N 7531 (Qty 2) and Antenna Mounting Bracket P/N 76516-09. FLHRC models require separate purchase of reflectors P/N 59370-98 and 59371-98.

49087-01 \$194.95

Fits '97-'08 FLHR, FLTR, FLHX and FLHT models. FLHRCI models require separate purchase of Reflector P/N 59370-98 and 59371-98. '04-'08 FLTR, FLHX and FLHRS models require separate purchase of Saddlebag Supports P/N 49194-85 and 90781-93 and two each of P/N 3601 and 7686. (Will not fit Saddlebag Guard Bags.)



C. REAR SADDLEBAG GUARDS – GLOSS BLACK ('09-'13 MODELS)



D. COMFORT PROFILE REAR SADDLEBAG GUARD KIT



***WARNING:** These guards may provide limited leg and cosmetic vehicle protection under unique circumstances (fall over while stopped, very low speed slide). They are not made nor intended to provide protection from bodily injury in a collision with another vehicle or any other object.

Notice: The prices appearing in this catalog are the manufacturer's suggested retail prices. Actual retail prices may vary.

368 TOURING & TRIKE

Luggage Accessories

A. PREMIUM TOUR-PAK® LUGGAGE FITTED LINING

Line your Touring bike's luggage to protect your belongings and reduce noise and rattles on the road. Soft-touch felt-finish liner is formed to the interior for a perfect fit. Molded base and sides maximize the interior room, and one-piece design allows easy removal for cleaning and maintenance.

53000323 King Tour-Pak® luggage. **\$89.95**
Fits '14-later Touring and Tri Glide® models equipped with King Tour-Pak luggage.

53301-06 King Ultra Tour-Pak luggage. **\$89.95**
Fits '93-'13 Touring (except FLHTK and '10-later CVO™) and Trike models equipped with King Tour-Pak luggage with incandescent wrap-around Tail Lamp Kit. Does not fit with Tour-Pak bottom tub mounted accessories.

53302-07 King Classic Tour-Pak luggage. **\$89.95**
Fits '93-'13 Touring and Trike models equipped with King Tour-Pak luggage without incandescent wrap-around Tail Lamp Kit. Does not fit with Tour-Pak bottom tub mounted accessories.

53000322 Chopped Tour-Pak luggage. **\$79.95**
Fits '14-later Touring and Tri Glide models equipped with Chopped Tour-Pak luggage. Does not fit with Tour-Pak bottom tub mounted accessories.

53285-06 Chopped Tour-Pak luggage. **\$79.95**
Fits '13-earlier Touring and Trike models equipped with Chopped Tour-Pak luggage. Does not fit with Tour-Pak bottom tub mounted accessories.

B. PREMIUM FITTED SADDLEBAG LINING

Protect your belongings and reduce noise and rattles on the road. Premium soft-touch felt-finish liner is formed to the hard saddlebag interior for a perfect fit. Molded base and sides maximize the interior room, and one-piece design allows easy removal for cleaning and maintenance.

90200918 **\$189.95**
Fits '14-later Touring models equipped with Color-Matched Hard Saddlebags.

92189-06 **\$159.95**
Fits '93-'13 Touring models equipped with Original Equipment Color-Matched Hard Saddlebags. Does not fit Police model saddlebags.



A. PREMIUM TOUR-PAK LUGGAGE FITTED LINING – KING ULTRA '93-'13 MODELS



A. PREMIUM TOUR-PAK LUGGAGE FITTED LINING – KING '14-LATER MODELS

A. PREMIUM TOUR-PAK LUGGAGE FITTED LINING – CHOPPED '14-LATER MODELS



A. PREMIUM TOUR-PAK LUGGAGE FITTED LINING – CHOPPED '13-EARLIER MODELS



B. PREMIUM FITTED SADDLEBAG LINING – '14-LATER MODELS

B. PREMIUM FITTED SADDLEBAG LINING – '93-'13 MODELS

Notice: The prices appearing in this catalog are the manufacturer's suggested retail prices. Actual retail prices may vary.

TOURING & TRIKE 369

Luggage Accessories



C. TOUR-PAK LID FITTED LINING WITH ORGANIZER – PREMIUM BLACK



C. TOUR-PAK® LID FITTED LINING WITH ORGANIZER – PREMIUM BLACK

Equip the Tour-Pak® lid to protect and store your belongings. This Premium Lid Lining features a soft-touch black felt finish to reduce noise, and a convenient series of storage pouches that provide easy access to all your essentials. Four flap pouches, and one mesh and one clear pocket provide plenty of storage and a great way to keep keys, cell phones, glasses, and papers handy. Hook-and-loop fasteners secure the one-piece formed lining to the lid, and allow easy removal for cleaning and maintenance.

53000392 **\$159.95**

Fits '14-later Touring and Tri Glide® models equipped with King or Chopped Tour-Pak luggage.



D. TOUR-PAK LID ORGANIZER/LINER – GRAY



D. TOUR-PAK LID FITTED LINING WITH ORGANIZER – GRAY

Add practical storage to your Tour-Pak luggage. This Lid Lining features a convenient six pocket organizer to keep smaller items conveniently at hand, and is shaped to fit the contours of the Tour-Pak lid for a finished look. The organizer features 4 enclosed pouches, 1 mesh pouch and 1 clear mobile-device pouch. The soft gray finish is the perfect match for the Original Equipment Tour-Pak bottom liner, and the hook-and-loop fasteners permit easy removal for cleaning.

53000302 **\$159.95**

Fits '14-later Touring and Tri Glide models equipped with King or Chopped Tour-Pak luggage.



E. TOUR-PAK LID ORGANIZER – TOUR-PAK



E. TOUR-PAK LID ORGANIZER

A true innovation in storage convenience and efficiency, this ingenious lid organizer helps keep smaller items conveniently located under your Tour-Pak lid for easy access. The organizer features five different-sized nylon-meshed pockets, as well as two flaps for additional storage. A great way to keep keys, cell phones, glasses, and papers handy.

53249-01B **\$94.95**

Fits '93-'13 Touring and Trike models equipped with a King, Ultra, Chopped or Razor-Pak Tour-Pak. Does not fit '08-later CVO™ Ultra models with Power Locks, or models equipped with Tour-Pak Spoiler Kit P/N 53149-series, Tour-Pak Light P/N 54302-98A, Mini Tour-Pak Lid Rack P/N 53100-96 or Contoured Tour-Pak Luggage Rack P/N 79148-06A.



F. TRUNK DOOR ORGANIZER



F. TRUNK DOOR ORGANIZER

For on-the-road storage and efficiency, this ingenious organizer helps keep smaller items conveniently located on your trunk door for easy access. The easy-to-install self-adhesive organizer features two large nylon-mesh pockets with hook-and-loop-secured flaps that offer quick access to keys, cell phones, glasses, gloves, and maps. Organizer features an embossed Harley-Davidson script logo. Add the matching Tour-Pak Lid Organizer P/N 53249-01B inside the Tour-Pak luggage for maximum organization.

93300001 **\$64.95**

Fits '09-later FLHTCUTG and '10-'11 FLHXXX models.

370 TOURING & TRIKE

Luggage Accessories

A. TOUR-PAK® WALL ORGANIZER

Convenient storage system wraps the interior walls of your King Tour-Pak® luggage for easy access to keys, cell phones, maps, and gloves. The organizer features a variety of mesh and enclosed pockets, sized perfectly to keep small items close at hand. Easily installed with included hook-and-loop tabs.

53000303 **\$104.95**
Fits '14-later Touring and Tri Glide® models (except CVO™) equipped with King Tour-Pak Luggage.

54014-05 **\$89.95**
Fits '93-'13 Touring and Trike models equipped with Ultra or King Tour-Pak luggage. Does not fit with Chopped or Razor-Pak Tour-Pak.



A. TOUR-PAK WALL ORGANIZER – '14-LATER MODELS

B. SADDLEBAG WALL ORGANIZER

Convenient storage system equips the interior wall of your Color-Matched Saddlebags for easy access to keys, cell phones, maps, and gloves. The organizer features a combination of mesh and enclosed pouches and pockets that are sized for safe, rattle-free packing. The organizer features a rigid backing that easily attaches to the wall of the saddlebag with the Original Equipment quick-release saddlebag fasteners. Kit includes left- and right-hand organizer.

90200882 **\$104.95**
Fits '14-later Touring models equipped with Color-Matched Hard Saddlebags. Does not fit with Boom!™ Audio Saddlebag Speaker Kit P/N 76000489.

88232-06 **\$59.95**
Fits '93-'13 Touring models equipped with Hard Saddlebags.



A. TOUR-PAK WALL ORGANIZER – '93-'13 MODELS

C. TRIKE SADDLEBAGS

Add additional storage at your fingertips. These vinyl-wrapped rigid side bags are a perfect match to either the Original Equipment or accessory seats and are contoured to fit comfortably under the passenger's legs. Featuring an easy-to-grip chrome-plated Bar & Shield finger pull, the forward-opening bags snap shut with a strong magnetic closure. The interior can accommodate 2 soda cans or water bottles side by side and is the ideal spot for sunscreen, glasses and your cell phone. Luggage capacity: 700 cubic inches total.

84031-11 **\$424.95**
Fits '09-later FLHTCUTG and '10-'11 FLHXXX models.



B. SADDLEBAG WALL ORGANIZER – ('14-LATER MODELS SHOWN)



C. TRIKE SADDLEBAGS

Notice: The prices appearing in this catalog are the manufacturer's suggested retail prices. Actual retail prices may vary.

TOURING & TRIKE 371

Luggage Accessories



D. PREMIUM TRAVEL-PAK – KING TOUR-PAK



D. PREMIUM TRAVEL-PAKS

This collection of fitted luggage provides convenient storage for your next long ride. The bags are manufactured of water resistant ballistic nylon that matches the premium luggage collection. The exterior features comfortable carrying handles, heavy-duty glove-friendly zippers, a zippered pocket, D-rings for optional carrying straps. The padded interior features a variety of convenient storage pockets and plenty of open storage. Saddlebag right-hand bag features an internal padded laptop pocket and plenty of smart storage spaces.

93300072 King Tour-Pak® luggage. **\$99.95**

Fits '93-later Touring and Trike models equipped with King Tour-Pak luggage.

93300070 Hard Saddlebags. **\$129.95**

Fits '93-later Touring models equipped with Hard Saddlebags. Sold in pairs.



D. PREMIUM TRAVEL-PAK – HARD SADDLEBAGS



E. TRAVEL-PAK – KING TOUR-PAK

E. TRAVEL-PAKS

Simplify packing and unpacking your motorcycle. These well-constructed, water-resistant bags are designed to fit perfectly into Touring model luggage systems. The soft sides conform to the interior of the luggage to help use every available inch of space. Styled with a Bar & Shield logo, they feature heavy-duty zippers and convenient carrying handles.

53605-97 King Tour-Pak luggage. **\$64.95**

Fits '93-later Touring and Trike models equipped with King and Ultra Tour-Pak luggage.

91885-97A Hard Saddlebags. **\$69.95**

Fits '93-later Touring models equipped with Color-Matched Hard Saddlebags and '09-'17 VRSCF models equipped with Rigid Saddlebags P/N 91172-09. Sold in pairs.

91887-98 Leather Saddlebags. **\$64.95**

Fits '98-later FLHRC and FLHRS models. Sold in pairs.

F. SADDLEBAG COOLER

Keep beverages and snacks cold right in your saddlebag on those hot summer rides. This zippered bag is fully lined and insulated, and fits the full length of your saddlebag.

90200991 **\$74.95**

Fits '93-later Touring models equipped with Color-Matched Hard Saddlebags.



E. TRAVEL-PAK – HARD SADDLEBAGS



E. TRAVEL-PAK – LEATHER SADDLEBAGS



F. SADDLEBAG COOLER



TOURING

Notice: The prices appearing in this catalog are the manufacturer's suggested retail prices. Actual retail prices may vary.

372 TOURING & TRIKE

Luggage Accessories

A. TRUNK TRAVEL-PAKS

These well-constructed, ballistic nylon bags are designed to fit perfectly into the rear or top-load trunk of the Harley-Davidson® Trike models. Styled to compliment the Premium Luggage Collection, the twin bags feature white piping and a reflective Bar & Shield logo. The bags feature glove-friendly zippered access to the main compartment and convenient outer pouches. Comfortable carrying straps make transportation a breeze. Sold in pairs.

53000431 **\$114.95**

Fits '09-later Trike models.



A. TRUNK TRAVEL-PAKS



A. TRUNK TRAVEL-PAKS

B. SADDLEBAG GUARD BAG WITH WATER BOTTLE HOLDER – BAR & SHIELD LOGO

Convenient on-the-go storage. Sturdy synthetic leather bags snap to the saddlebag guards for easy access. The storage compartment features a hook-and-loop outer flap and a zippered inner closure to store sunglasses, wallets and cell phones, and the adjoining sleeve securely grips a removable water bottle to help keep you hydrated on the road.

Fits '93-later Touring models equipped with Saddlebag Guards.

93300060 Right Side. **\$79.95**

93300061 Left Side. **\$79.95**

C. SADDLEBAG GUARD BAG – BAR & SHIELD LOGO

Keep your essentials close at hand. Bags are constructed of sturdy synthetic leather, with hook-and-loop flap covers and a dual zippered opening that provides easy access to the interior. A separate internal zippered soft pouch is perfect for storing smaller items or sunglasses. Synthetic leather bags snap tightly to the saddlebag guard.

Fits '93-later Touring models equipped with Saddlebag Guards.

93300062 Right Side. **\$79.95**

93300063 Left Side. **\$79.95**



A. TRUNK TRAVEL-PAKS



B. SADDLEBAG GUARD BAG WITH WATER BOTTLE HOLDER – BAR & SHIELD LOGO



C. SADDLEBAG GUARD BAG – BAR & SHIELD LOGO

Notice: The prices appearing in this catalog are the manufacturer's suggested retail prices. Actual retail prices may vary.

TOURING & TRIKE 373

Luggage Accessories



D. SADDLEBAG LID BRA
(90200992 SHOWN)



D. SADDLEBAG LID BRA
(57805-03A SHOWN)

D. SADDLEBAG LID BRA

Protect your saddlebags from boot scuffs, stone chips and road debris. These custom-fit Saddlebag Lid Bras are made with non-abrasive, fleece-backed vinyl material and feature small Bar & Shield logos. Easy to install with hook-and-loop tabs. Kit includes left and right side Lid Bras.

90200992 **\$99.95**

Fits '14-later Touring models with Color-Matched Hard Saddlebags. Does not fit with Saddlebag Lid Rails, Saddlebag Lid Spoilers or Saddlebag Lid Speakers.

57805-03A **\$99.95**

Fits '93-'13 Touring models equipped with Color-Matched Hard Saddlebags. Does not fit with Police Model Hard Saddlebags, Saddlebag Lid Rails, Saddlebag Lid Spoilers, or Saddlebag Wing Tips.

E. TANK BRA

Manufactured from non-abrasive, fleece-backed vinyl, this Tank Bra for your Touring model features an embroidered Bar & Shield logo. It protects your fuel tank from belt buckle and key scratches and nicks from road debris. Designed for easy installation and a custom fit without tank or seat removal.

62063-01 **\$44.95**

Fits '97-later Touring and Trike models.

F. TRIKE REAR FENDER BRA

Protect your Trike's rear fenders from boot scuffs and road debris. These rich black Fender Bras are constructed of non-abrasive fleece-backed smooth vinyl, and are simple to install. Featuring a prominent embossed Bar & Shield logo, these Bras are styled to coordinate with the matching Fairing Bra P/N 57800-00.

57892-11 **\$99.95**

Fits '09-later FLHTCUTG and '10-'11 FLHXXX models. Not for use with Chrome Fender Trim Kit P/N 83812-09. Does not fit '17-later Canada FLHTCUTG.

G. TRIKE SCUFF GUARDS

Guard against heel marks and stone chips on the leading edges of the rear fender and body of your Trike model. These heavy-duty molded rubber pads are shaped to match the contour of the body, and are easy to install with the pre-applied adhesive. The ribbed surface pattern mirrors the Original Equipment footboard inserts, and offers a clean, smooth-flowing look between the footboards and body.

Fits '09-later FLHTCUTG and '10-'11 FLHXXX models.

83968-10 Body Scuff Guards. **\$29.95**

83976-10 Fender Scuff Guards. **\$39.95**



E. TANK BRA



F. TRIKE REAR FENDER BRA



G. TRIKE SCUFF GUARDS — BODY & FENDER



G. TRIKE SCUFF GUARDS — FENDER



G. TRIKE SCUFF GUARDS — BODY

Notice: The prices appearing in this catalog are the manufacturer's suggested retail prices. Actual retail prices may vary.

374 TOURING & TRIKE

Foot Controls

A. EXTENDED REACH RIDER FOOTBOARD PANS

This kit extends the rider footboard forward of the stock location by one inch, providing the tall rider a comfortable riding position. When paired with Extended Reach Brake and Shift Levers, these pans allow riders with large boot sizes ample room to reposition their feet during a long ride. Available in traditional D-shape or Swept Wing design, Extended Reach footboard pans accept Original Equipment or accessory rider footboard inserts. The kit includes left and right footboard pans.

Fits '02-later Touring (except FLHTCUL and FLHTKL) and Trike models. Also fits '97-'01 Touring models equipped with Extended Reach Billet Style Brake Lever P/N 42638-03.

50409-04	Traditional Shape.	\$89.95
54145-10	Swept Wing.	\$89.95

B. EXTENDED LENGTH RIDER RUNNING BOARDS

Stretching your legs and moving your feet during a long ride relieves muscle tension and reduces rider fatigue. At 4.0" longer (1.0" in front, 3.0" in back) and .5" wider than the Original Equipment rider footboards, these ergonomically friendly running boards provide plenty of space for riders to reposition their feet for maximum comfort. When used in conjunction with available Extended Brake and Shift Levers, the long legged rider will have even more room to stretch out on long rides. The easy-to-install kit includes left and right footboard pans with vibration-isolated inserts that are styled to complement the Crested Bar & Shield controls collection, or most other chrome and rubber collections.

50500158 **\$199.95**

Fits '00-'17 FL Softail® (except FLS, FLSS, FLSTFB, FLSTFBS, FLSTN, FLSTNSE, FLSTSE and FXSE or Softail models with Profile® Low Suspension). Also fits '00-later Touring (except FLHTCUL, FLHTCUL TC and FLHTKL) and '09-'13 Trike models. Not for use with Jiffy Stand Kit P/N 50000091 or Jiffy Stand Extension Kit P/N 50233-00, 50000008 and 50000023.

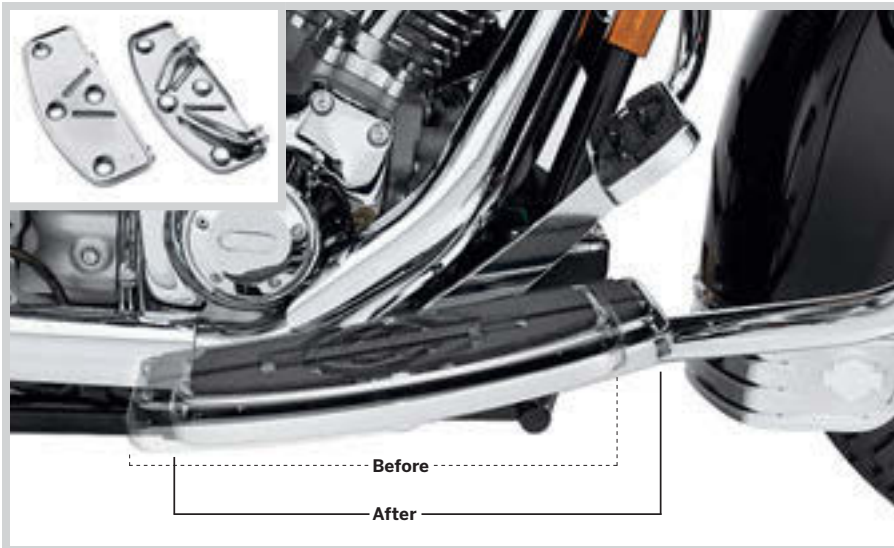

A. EXTENDED REACH RIDER FOOTBOARD PANS – TRADITIONAL SHAPE

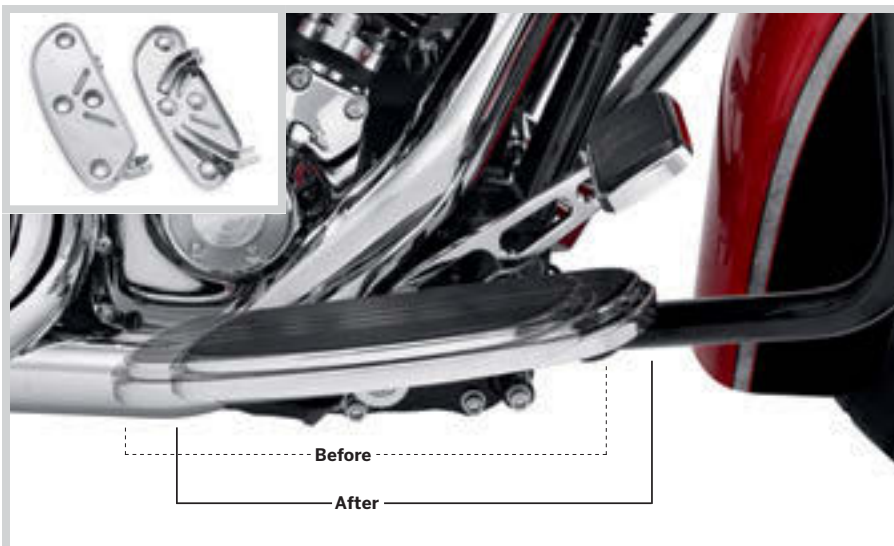

A. EXTENDED REACH RIDER FOOTBOARD PANS – SWEEP WING



B. EXTENDED LENGTH RIDER RUNNING BOARDS

Notice: The prices appearing in this catalog are the manufacturer's suggested retail prices. Actual retail prices may vary.

TOURING & TRIKE 375

Foot Controls



C. BLACK RIDER FOOTBOARD PANS – TRADITIONAL SHAPE



C. BLACK RIDER FOOTBOARD PANS – SWEEP WING SHAPE

C. BLACK RIDER FOOTBOARD PANS

Complete the blacked-out transformation. Replace the Original Equipment chrome footboard pans with sinister gloss black. Kit includes both the right and left pan, and is installed using the Original Equipment hardware and insert pad. Custom footboard inserts are sold separately.

Fits '12-'16 FLD and '86-'17 FL Softail® (except FLS, FLSS, FLSTFB and FLSTFBS), '86-later Touring (except FLHTCUL, FLHTCUL TC and FLHTKL) and Trike models.

51322-08	Traditional Shape.	\$99.95
51060-08	Swept Wing Shape.	\$99.95

D. STREAMLINER RIDER FOOTBOARD KIT

Add the sleek sweeping footboard design from the Street Glide® model to your Touring bike. Kit includes vibration-isolation footboard pads with three chrome bands, and the complete chrome-plated pans that easily bolt in place of the Original Equipment footboards.

50631-04 **\$229.95**

Fits '12-later FLD, '86-'17 FL Softail (except FLS, FLSS, FLSTFB and FLSTFBS), '86-later Touring (except FLHTCUL and FLHTKL) and Trike models.

E. JIFFY STAND EXTENSION

Jiffy Stand Extension Kits have been ergonomically designed to simplify the deployment and retraction of the jiffy stand. The extension is shaped to simplify locating the tab with your boot, and aid in swinging the jiffy stand into position. The move feels natural, and adds confidence when parking your motorcycle in a tight spot. Kit mounts to Original Equipment jiffy stand, and includes all required mounting hardware.

50000023 **\$39.95**

Fits '91-later Touring models. Does not fit model equipped with Defiance footboards, Burst footboards, or Rider Running Boards P/N 50500158.

F. RIDER FOOTBOARD HEEL GUARD

Avoid damaged boots and hours of cleaning melted rubber scuff marks from your exhaust shield. This Heel Guard mounts to the right-side rider footboard and protects your boot from contact with the hot exhaust shield. The subtle curved shape keeps the boot heel away without restricting fore-and-aft movement of the rider's foot. Kit includes chrome guard with cutaway Bar & Shield logo and all mounting hardware.

50500225 **\$69.95**

Fits '12-'16 FLD, '86-'17 FL Softail, '86-later Touring and '09-later Trike models equipped with Traditional and Swept Wing footboards. Does not fit models equipped with Half-Moon, Tapered, Airflow, Defiance or Burst footboards, Extended Reach Rider Footboards P/N 50409-04 or 54145-10, Rider Running Boards P/N 50500158 or Screamin' Eagle® Fat Exhaust Shields.



D. STREAMLINER RIDER FOOTBOARD KIT



E. JIFFY STAND EXTENSION



F. RIDER FOOTBOARD HEEL GUARD



F. RIDER FOOTBOARD HEEL GUARD

376 TOURING & TRIKE

Foot Controls

A. BILLET STYLE BRAKE LEVER – EXTENDED REACH

Ride tall in the saddle. This billet style Brake Lever features a 1.0" longer arm than the Original Equipment brake lever, allowing tall riders to stretch their legs and straighten their knees for added comfort and control. The additional room also provides riders with large boot sizes ample room to move and reposition their feet on the footboard. Styled to complement our billet style mirror stems, these Billet Style Brake Levers are forged, machined and polished for a beautiful, custom look. When combined with the available Extended Reach Shift Lever, long-limbed riders can straighten their legs and ride in comfort. Brake pedal pads sold separately.

41600012	Chrome.	\$179.95
Fits '08-'13 Touring models (except FLHTCU, FLHTK, FLTRU and models equipped with fairing lowers).		
42638-03	Chrome.	\$174.95
Fits '97-'07 Touring models.		



A. EXTENDED BRAKE LEVER – COMPARISON TO STOCK LENGTH



A. BILLET STYLE BRAKE LEVER – EXTENDED REACH

B. BILLET STYLE REAR BRAKE LEVER

Styled to complement our billet style mirror stems and shift levers, these Billet Style Rear Brake Levers are forged from billet aluminum, then machined and polished for a beautiful, custom look. Available in your choice of finishes. Lever matches the length of the Original Equipment brake lever. Brake pedal pads sold separately.

Fits '14-later Touring and Trike models.

41600082	Chrome.	\$179.95
41600079	Edge Cut.	\$179.95
41600208	Satin Black.	\$179.95

Fits '08-'13 Touring and Trike models.

42638-08A	Chrome.	\$179.95
40091-10	Edge Cut.	\$179.95

C. AIRFLOW COLLECTION REAR BRAKE LEVER

Forged from billet aluminum, this brake lever makes its own custom statement. Featuring a deep groove that runs the length of the arm, the swept shape of the lever adds a strong visual element to the bike's profile. Designed to match the Airflow collection, this lever complements your contemporary or classic styling direction. Airflow lever matches the Original Equipment length to maintain the factory riding position. Brake pedal pads sold separately.

Fits '14-later Touring and Trike models.

41600146	Chrome.	\$179.95
41600280	Gloss Black.	\$174.95



B. BILLET STYLE REAR BRAKE LEVER – CHROME



B. BILLET STYLE REAR BRAKE LEVER – EDGE CUT



B. BILLET STYLE REAR BRAKE LEVER – SATIN BLACK



C. AIRFLOW COLLECTION REAR BRAKE LEVER

Notice: The prices appearing in this catalog are the manufacturer's suggested retail prices. Actual retail prices may vary.

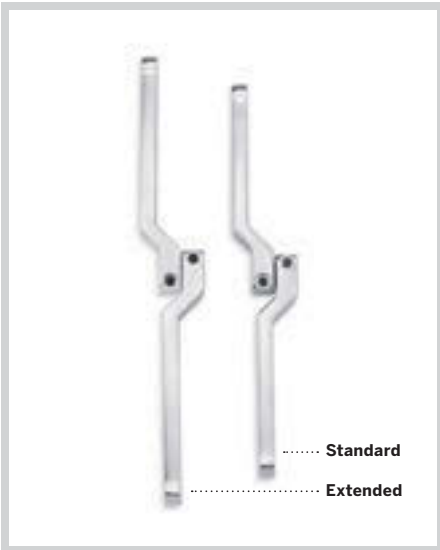

**D. EXTENDED HEEL/TOE SHIFT LEVER –
COMPARISON TO STOCK**

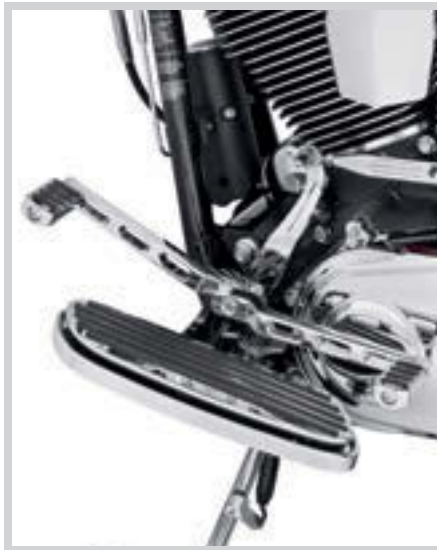

**D. BILLET STYLE HEEL/TOE SHIFT LEVER –
EXTENDED REACH**



**E. BILLET STYLE HEEL/TOE SHIFT LEVER –
STANDARD LENGTH, CHROME**



**E. BILLET STYLE HEEL/TOE SHIFT LEVER –
STANDARD LENGTH, EDGE CUT**



**E. BILLET STYLE HEEL/TOE SHIFT LEVER –
STANDARD LENGTH, SATIN BLACK**



**F. AIRFLOW COLLECTION HEEL/TOE
SHIFT LEVER**

**D. BILLET STYLE HEEL/TOE SHIFT LEVER –
EXTENDED REACH**

Stretch out in style. Both the heel and toe sections of this Shift Lever are 1.0" longer than traditional levers, separating the distance between the heel/toe shift by 2.0" total. This added space provides a comfortable riding position for a tall rider, and allows a rider with a large boot extra room to move. Styled to complement our billet style mirror stems, these Billet Style Shift Levers are forged, machined and polished for a beautiful, custom look. When combined with the available Extended Reach Brake Lever, long-limbed riders can straighten their legs and ride in comfort. Kit includes a front and rear lever and mounting hardware.

33600001 Chrome. **\$159.95**
 Fits '86-'17 FL Softail®, '88-later Touring and '08-later Trike models.

**E. BILLET STYLE HEEL/TOE SHIFT LEVER –
STANDARD LENGTH**

Styled to complement our billet style mirror stems, these Billet Style Shift Levers are forged from 7075-T6 aluminum, then machined and polished for a beautiful, custom look. Available in your choice of mirror chrome, satin black powder coat, or edge cut black anodized and machined aluminum finishes. Kit includes a front and rear lever and chrome hardware.

Fits '86-'17 FL Softail, '88-later Touring and '08-later Trike models.

34535-00B Chrome. **\$159.95**
34045-10 Edge Cut. **\$159.95**
34023-08 Satin Black. **\$159.95**

F. AIRFLOW COLLECTION HEEL/TOE SHIFT LEVER

Styled to complement the Airflow Collection, this forged billet aluminum shift lever adds a custom touch to your bike. The lever features a deep groove that catches light and draws your eye. The separate front and rear levers can be easily adjusted for convenient shifting, and the extended-length rear lever provides additional space for larger boots. Kit includes a front and rear lever and mounting hardware. Lever accepts stock or accessory shifter pegs.

Fits '86-'17 FL Softail, '88-later Touring and '08-later Trike models.

33600076 Chrome. **\$154.95**
33600255 Gloss Black. **\$149.95**

Notice: The prices appearing in this catalog are the manufacturer's suggested retail prices. Actual retail prices may vary.

378 TOURING & TRIKE

Foot Controls

A. FOLDING HEEL SHIFTER

Give your left foot a little extra room. The Folding Heel Shifter permits the rider to move the rear shift peg out of the way when on the open road, while retaining heel/toe shift functionality around town. Positive detent holds the peg in the selected position, and can be adjusted while riding. Easy to install, the replacement rear lever is chrome-plated, and shaped to match the Original Equipment toe shift lever. Lever accepts stock or accessory shifter peg.

33876-07 **\$79.95**
Fits '86-'17 FL Softail®, '88-'16 Touring and '08-'16 Trike models.



A. FOLDING HEEL SHIFTER – RETRACTED POSITION

B. HEEL/TOE SHIFTER SHAFT COVER

Conceal the splined end of the shifter shaft when you remove the heel shift lever. The easy-to-install chrome-plated aluminum billet cap is held in place with a flush Allen® screw for a clean look.

35471-05 **\$18.95**
Fits '82-'17 FL Softail, and '82-later Touring and Trike models equipped with heel/toe shift levers. Installation requires removal of heel shift lever.



B. HEEL/TOE SHIFTER SHAFT COVER

C. SHIFTER SHAFT LEVER – GLOSS BLACK

The perfect companion to black or edge-cut heel and toe shift levers and shift linkages, this Gloss Black Shifter Shaft Lever creates an uninterrupted blacked-out look from the front of the engine to the rear. Manufactured from Original Equipment components, this lever is an exact replacement for the factory-installed chrome plated part.

33900186 **\$39.95**
Fits '93-'16 Touring and Trike models.



C. SHIFTER SHAFT LEVER – GLOSS BLACK

D. JIFFY STAND AND MOUNT KIT – GLOSS BLACK

With this beautiful gloss black jiffy stand kit, your Dark Custom Touring model won't just stand on its own – it will stand out. Using the Original Equipment jiffy stand and mount to ensure quality and fitment, these pieces are finished in rich gloss black to blend into the frame and help disguise this very visual component on the vehicle. Installation reuses Original Equipment spring and hardware.

50000122 **\$224.95**
Fits '07-'16 Touring models (except FLHTCUL and FLHTKL).



D. JIFFY STAND AND MOUNT KIT – GLOSS BLACK

E. REAR MASTER CYLINDER COVER – CHROME

An easy way to add chrome to your bike is with this chrome-plated version of the stock master cylinder cover.

46463-08 **\$59.95**
Fits '08-later Touring models. Does not fit Trike models.

46425-05A **\$39.95**
Fits '06-'17 Dyna® non-ABS models, '06-'17 Softail and '05-'07 Touring models.

45149-99C **\$39.95**
Fit '00-'05 Softail and '99-'04 Touring models.



E. REAR MASTER CYLINDER COVER – CHROME

Notice: The prices appearing in this catalog are the manufacturer's suggested retail prices. Actual retail prices may vary.

NEW

TOURING & TRIKE 379

Foot Controls



F. CUSTOM GEAR SHIFT LINKAGE – ROUND GLOSS BLACK

F. CUSTOM GEAR SHIFT LINKAGE – ROUND GLOSS BLACK

Add the finishing touch to your blacked-out ride. This Gloss Black Shift Linkage is easy to install and includes a transmission lever cover and decorative acorn nuts and bolts for a complete custom look.

33600259 **\$99.95**

Fits '86-later Softail® (except '18-later FXBB and FXLR), Touring and Trike models. (Does not fit '97-'99 FLSTS or models equipped with Softail Extended Reach Forward Controls.)

G. CUSTOM GEAR SHIFT LINKAGES

Kick your custom into gear with this collection of high-quality Custom Shift Linkages. Available in a variety of designs to match your bike's style, these aluminum linkages feature aircraft-quality rod ends for easy adjustment and smooth operation. The easy-to-install linkage kit also includes a transmission lever cover for '86-'17 Softail and '86-'16 Touring and Trike models, and decorative acorn nuts and bolts for a complete custom look.

Fits '86-later Softail (except '18-later FXBB and FXLR), Touring and Trike models. (Does not fit '97-'99 FLSTS or models equipped with Softail Extended Reach Forward Controls.)

1. 34018-08	Slotted – Black Anodized.	\$129.95
2. 34850-09	Skull.	\$129.95
3. 33801-09	Harley-Davidson Script.	\$129.95
4. 33760-09	Slotted with Bar & Shield Logo.	\$129.95
5. 33814-98A	Round.	\$89.95

H. GEAR SHIFT LINKAGE COVERS

A simple and inexpensive way to detail your Touring bike. These easy-to-install chrome-plated covers conceal the stock gear shifter linkage for a brilliant finish. Kit includes all necessary mounting hardware.

Fits '99-'16 Touring and Trike models with stock gear shift linkage.

1. 46303-01	Harley-Davidson Script.	\$46.95
2. 46305-01	Engraved Harley-Davidson.	\$46.95



G. CUSTOM GEAR SHIFT LINKAGES



H. GEAR SHIFT LINKAGE COVERS

Notice: The prices appearing in this catalog are the manufacturer's suggested retail prices. Actual retail prices may vary.

380 TOURING & TRIKE

Foot Controls

A. PASSENGER MINI FOOTBOARD MOUNT KIT

This mount kit permits replacement of the Original Equipment passenger footboards with footpegs or mini footboards, and moves the passenger's foot rearward and inward to give the rider more space between the rider footboard and the passenger foot support. The new position clears the path for your feet to ease walking the bike in and out of parking spaces. When folded, the pegs are tighter to the bike to reduce the chance of contacting the passenger foot support with your calf. Original equipment on FLHTCUL and FLHTKL models, this Footpeg Mount Kit is the ideal solution for short-limbed riders. Kit includes left and right mount, and required installation hardware. Male-mount style passenger footpegs or mini-footboards sold separately.

50500403A **\$99.95**
Fits '93-later Touring models. Does not fit Trike models.



A. PASSENGER MINI FOOTBOARD MOUNT KIT

B. PASSENGER FOOTPEG MOUNT – GLOSS BLACK

Manufactured from Original Equipment components for proper fit and proven strength, these footpeg supports replace the factory chrome-finished mounts for a clean, custom look. When installed with blacked-out accessory footpegs, these gloss black footpeg supports tie the pegs to the bike for a seamless, no-contrast look. Kit includes right and left hand mount.

50500578 **\$149.95**
Fits '93-later Touring models. Does not fit Trike models.



B. PASSENGER FOOTPEG MOUNT – GLOSS BLACK

C. PASSENGER FOOTPEG MOUNT KIT – CHROME

Designed specifically for the sport-touring rider, this chrome-plated kit allows passenger footboards to be removed and replaced with a variety of male mount-style Harley-Davidson® footpegs. The kit has 3 adjustable height positions and includes all hardware.

50198-97B **\$129.95**
Fits '93-later Touring models. Does not fit Trike models.



C. PASSENGER FOOTPEG MOUNT KIT – CHROME

D. ADJUSTABLE PASSENGER FOOTPEG MOUNT KIT

Maximize your passenger's riding comfort. Proper foot position reduces the cramped or stretched-out feeling, and relieves pressure on the knees and the tailbone. These adjustable mounts raise and lower the passenger footpeg to accommodate taller and shorter passengers. Easy to adjust with common tools, the mount adjusts through a 360° range (depending on model), allowing both fore and aft and up and down height adjustment. Kit includes left and right adjustable support assembly and all required mounting hardware. Footpegs sold separately.

50763-09 **\$149.95**
Fits models with H-D® male mount-style passenger footpeg supports (except Softail® models). Does not fit with Heel Raiser Footpeg Kit P/N 50178-09. Does not fit the rider position.



D. ADJUSTABLE PASSENGER FOOTPEG MOUNT KIT

E. PASSENGER FOOTBOARD SUPPORTS

Add the comfort and convenience of passenger footboards to your Touring motorcycle. These supports are designed to allow installation of traditional D-shaped, Swept Wing, Tapered or Old-Style Passenger Footboards (sold separately) on Touring models. Kit includes left and right supports and installation hardware. Add your choice of passenger footboard pan design and footboard insert to complete your custom look.

Fits '93-later Touring and Trike models.

50500042 Black. **\$109.95**
53070-00A Chrome. **\$139.95**



E. PASSENGER FOOTBOARD SUPPORTS – BLACK



E. PASSENGER FOOTBOARD SUPPORTS – CHROME

Notice: The prices appearing in this catalog are the manufacturer's suggested retail prices. Actual retail prices may vary.



F. ADJUSTABLE AUXILIARY PASSENGER FOOTPEG MOUNTS – FORWARD & MID POSITION



F. ADJUSTABLE AUXILIARY PASSENGER FOOTPEG MOUNTS – REAR POSITION



G. ADJUSTABLE PASSENGER FOOTBOARD MOUNT KIT

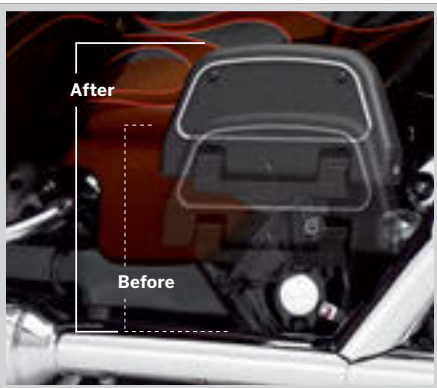

H. REACH PASSENGER FOOTBOARD MOUNT KIT



F. ADJUSTABLE AUXILIARY PASSENGER FOOTPEG MOUNTS

These 3-position adjustable passenger footpeg mounts will keep your companion happy over the long haul. Push-button adjustment lets the passenger reposition their feet to keep blood flowing in all the lower extremities. When combined with the standard footboard, both short and long-limbed passengers should be able to find a comfortable riding position. Pegs can also be pivoted fully rearward to allow the rider the room to get his or her feet on the ground when walking the bike in and out of parking spaces. Kit includes beautifully chromed left- and right-side adjustable mounts and all installation hardware. Complete the custom look with your choice of footpegs (sold separately).

54157-10 **\$249.95**

Fits '10-later Touring models with Original Equipment passenger footboards (except CVO™ models or models equipped with Adjustable Passenger Footboard Mount Kit P/N 50768-07A). Also fits '93-later Touring models equipped with Passenger Footboard Kit P/N 50378-07B, 50379-07B or 53070-00A. Does not fit Trike models or models equipped with sidecars. Will not fit with Footpeg P/N 49117-77TB, 49110-98, 91821-85, 50643-82, 50647-82, 49500-92T, 49234-98, 50978-99, 50976-99, 50911-08, 50113-10, 50695-08, 49128-82, 50056-10, 50039-10, 49312-10, 50451-09 and 50178-09.

G. ADJUSTABLE PASSENGER FOOTBOARD MOUNT KIT

Maximize your passenger's riding comfort. These chrome 5-position adjustable mounts raise and lower the passenger footboard. The lowest position is 2.0" forward from stock, and the highest position is 2.5" higher than stock. Easy to adjust with a common hex wrench. Kit includes left and right adjustable support assembly and all required mounting hardware. Footboard pans and inserts sold separately.

50768-07A **\$379.95**

Fits '93-later Touring models. Does not fit Trike models.

H. REACH PASSENGER FOOTBOARD MOUNT KIT

Kit raises the height of your passenger footboards by approximately 2.25" for increased passenger comfort. Especially desirable on '97-later Touring models due to the frame and saddlebag guard change. Includes mounting hardware.

50789-99B **\$129.95**

Fits '93-later Touring models. Does not fit Trike models. Does not fit with saddlebag guard bags.

382 TOURING & TRIKE

Foot Controls

A. PASSENGER FOOTBOARD AND MOUNT KIT

Convenient bolt-on installation. Includes specially designed mounting stud/brackets for proper installation. Footboards fold up when not in use. Kit includes Original Equipment-style aluminum footboards, rubber pads, mounting hardware and passenger footboard supports.

50379-07B **\$149.95**
Fits '93-later Touring and Trike models.



A. PASSENGER FOOTBOARD AND MOUNT KIT

B. STREAMLINER PASSENGER FOOTBOARD AND MOUNT KIT

Styled to match the rider footboards on the Road King® Custom, Road Glide® Custom and Street Glide® models, these Swept Wing Passenger Footboards feature a Streamliner-style rubber pad surrounded by a chrome accent. The smooth Swept Wing footboard pan is chrome-plated throughout to add a custom touch, even in the folded position. Designed for convenient bolt-on installation, the complete kit includes chrome-plated aluminum footboards, rubber pads, mounting hardware and passenger footboard supports.

50378-07B **\$399.95**
Fits '93-later Touring models. Does not fit Trike models.



B. STREAMLINER PASSENGER FOOTBOARD AND MOUNT KIT

C. PASSENGER FOOTBOARD PANS – CHROME

Replace the factory black painted passenger footboard with the custom look of smooth chrome. The kit includes left- and right-hand traditional D-shaped footboard pans, chrome-plated, and ready to install with your Original Equipment hardware. Footboard inserts and footboard supports sold separately.

50752-04 **\$169.95**
Fits '06-'17 Dyna®, '00-later Softail® (except FXDRS) and '86-later Touring and Trike models equipped with passenger footboard supports.



C. PASSENGER FOOTBOARD PANS – CHROME



D. SWEEP WING PASSENGER FOOTBOARD PANS

These unique Swept Wing Passenger Footboard pans complement the Swept Wing Rider Footboard shape, and allow you to replace the Original Equipment passenger footpegs on certain models with footboards. When folded, the footboard displays a mirror chrome surface in your choice of smooth or ball-milled, grooved design. Footboard inserts and footboard supports sold separately.

Fits '06-'17 Dyna®, '00-later Softail (except FXDRS) and '86-later Touring models equipped with passenger footboard supports. Does not fit Trike models.

50716-04 Chrome – Smooth. **\$169.95**
50357-04 Chrome – Grooved. **\$169.95**



D. SWEEP WING PASSENGER FOOTBOARD PANS – CHROME SMOOTH



D. SWEEP WING PASSENGER FOOTBOARD PANS – CHROME GROOVED

Notice: The prices appearing in this catalog are the manufacturer's suggested retail prices. Actual retail prices may vary.

TOURING & TRIKE 383

Foot Controls



E. HALF-MOON PASSENGER FOOTBOARD PANS – CHROME



E. HALF-MOON PASSENGER FOOTBOARD PANS – GLOSS BLACK

E. HALF-MOON PASSENGER FOOTBOARD PANS AND INSERTS

Styled to match the Half-Moon Rider Footboards, these classic passenger footboards add both style and comfort to your nostalgic ride. Available in mirror-finish chrome or gloss black finish, the kit includes left and right footboard pan and vibration-isolation footboard inserts. Model-specific footboard mounts are sold separately.

Fits '06-'17 Dyna®, '00-later Softail® (except FXDRS) and '86-later Touring models equipped with passenger footboard supports. Does not fit Trike models.

50807-08	Chrome.	\$189.95
50810-08	Gloss Black.	\$189.95

F. ROAD KING® CLASSIC PASSENGER FOOTBOARD COVERS

The latest in the family of Road King® Classic-inspired accessories, this chrome-plated steel footboard cover features a chrome die-cast Road King Classic medallion with black accents and a stylish leather accent piece. Mounting hardware included.

50246-00 **\$79.95**

Fits '06-'17 Dyna, '86-'17 FL Softail and '87-later Touring and Trike models equipped with traditional D-shaped aluminum passenger footboards.



F. ROAD KING CLASSIC PASSENGER FOOTBOARD COVERS



G. V-LOGO PASSENGER FOOTBOARD COVERS

V-Logos are die-cast aluminum integrated with the cover, then chrome-plated for a desirable shine. Includes all mounting hardware.

50194-96 **\$69.95**

Fits '06-'17 Dyna, '86-'17 FL Softail and '87-later Touring and Trike models equipped with traditional D-shaped aluminum passenger footboards.

H. CONCHO PASSENGER FOOTBOARD COVERS

Heritage Softail® Classic-inspired conchos make these covers look great whether footboards are up or down.

50193-96 **\$79.95**

Fits '06-'17 Dyna, '86-'17 FL Softail and '87-later Touring and Trike models equipped with traditional D-shaped aluminum passenger footboards.



G. V-LOGO PASSENGER FOOTBOARD COVERS



H. CONCHO PASSENGER FOOTBOARD COVERS

I. HARLEY-DAVIDSON SCRIPT PASSENGER FOOTBOARD COVERS

These easy-to-install chrome covers are formed to fit over the stock footboard pan to add a touch of style to the profile of your bike. The simple, clean design features a deep embossed Harley-Davidson script for a finishing touch. Kit includes chrome mounting hardware.

50782-91 **\$69.95**

Fits '06-'17 Dyna, '86-'17 FL Softail and '87-later Touring and Trike models equipped with traditional D-shaped aluminum passenger footboards.



I. HARLEY-DAVIDSON SCRIPT PASSENGER FOOTBOARD COVERS

TOURING

Notice: The prices appearing in this catalog are the manufacturer's suggested retail prices. Actual retail prices may vary.

384 TOURING & TRIKE

Engine Guards

A. MUSTACHE ENGINE GUARD*

Combine classic shape and modern function for a unique twist on engine protection. The flow of this engine guard complements the bike's traditional style while the gracefully curved upper section incorporates highway pegs into the shape. The integrated rubber pads offer a comfortable and slip-resistant cushion for your feet while traveling the open road. One-piece engine guard kit includes all required mounting hardware.

Fits '09-later Touring and Trike models (except Road Glide®). Does not fit models equipped with fairing lowers. '15-later FLRT models require the separate purchase of bracket P/N 45700054. '10-'11 FLHXXX models require the separate purchase of Bracket P/N 83865-09.

49155-09B	Chrome.	\$279.95
49442-10A	Gloss Black.	\$279.95

Fits '97-'08 Touring models (except Road Glide). Does not fit models equipped with fairing lowers.

49155-05B	Chrome.	\$289.95
------------------	---------	-----------------

B. ENGINE GUARD – CHROME*

Protect your bike without sacrificing ground clearance or style. The one-piece engine guard is designed to complement the lines of the motorcycle, and the bright chrome finish adds the perfect finishing touch.

49184-09A	\$219.95
------------------	-----------------

Fits '09-later Touring and Trike models. '15-later FLRT models require the separate purchase of bracket P/N 45700054. '10-'11 FLHXXX models require the separate purchase of Bracket P/N 83865-09.

C. ENGINE GUARD – GLOSS BLACK*

Protect your bike without sacrificing ground clearance or style. The one-piece engine guard is designed to complement the lines of the motorcycle, and the black finish adds the perfect finishing touch. Before the tough black powder coat finish is applied, these engine guards get an extra layer of protection from an E-Coat dip. So go on and install Engine Guard Mount Footpegs because this finish will go the distance.

49050-09A	\$219.95
------------------	-----------------

Fits '09-later Touring and Trike models. '15-later FLRT models require the separate purchase of bracket P/N 45700054. '10-'11 FLHXXX models require the separate purchase of Bracket P/N 83865-09.

46549-03	Fits '97-'08 Touring models.	\$219.95
-----------------	------------------------------	-----------------

D. CENTER STAND

Lifting your bike upright and off the side stand is ideal for cleaning and servicing, and reduces the space required for parking – handy where space is at a premium in a crowded garage, a small parking spot, or at a ride-in bike show. The robust chrome Center Stand attaches directly to the frame and does not reduce the lean angle. Designed to work with all Original Equipment suspension configurations and with Profile® suspension lowering kits, the adjustable feet can be set to lift the rear tire clear of the pavement, or to keep the rear tire on the ground for reduced lifting effort. The lifting lever is inconspicuously tucked away, and fits with all Harley-Davidson® Original Equipment and accessory footboards. Kit includes chrome stand, black mounting brackets, and all necessary installation hardware.

91573-09A	\$334.95
------------------	-----------------

Fits '09-later Touring models (except FLHTKSE, FLTRUSE, '07-'11 FLHTCUSE and models equipped with Adjustable Passenger Footboard Mount Kit P/N 50768-07) with Original Equipment or Profile® Low Suspension.

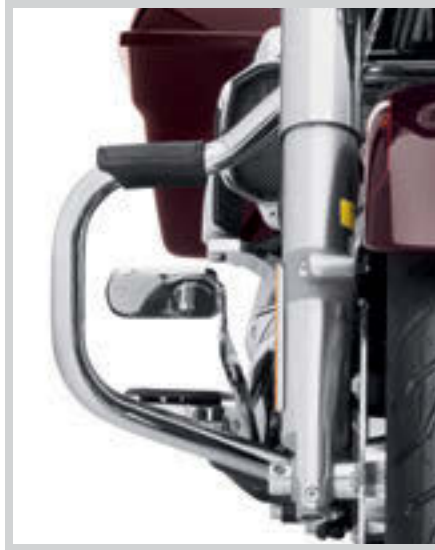

A. MUSTACHE ENGINE GUARD – CHROME



A. MUSTACHE ENGINE GUARD – GLOSS BLACK



B. ENGINE GUARD – CHROME



C. ENGINE GUARD – GLOSS BLACK



D. CENTER STAND



***WARNING:** Engine guards may provide limited leg and cosmetic vehicle protection under unique circumstances (fall over while stopped, very low speed slide). They are not made nor intended to provide protection from bodily injury in a collision with another vehicle or any other object.



***WARNING:** Do not use engine guard footpegs under normal stop and go operating conditions. Doing so could result in death or serious injury.



***WARNING:** Do not use highway pegs under normal stop and go operating conditions. Doing so could result in death or serious injury.

Notice: The prices appearing in this catalog are the manufacturer's suggested retail prices. Actual retail prices may vary.

TOURING & TRIKE 385

Engine Guards

E. CHOPPED ENGINE GUARD*

Create a sleek, slammed look on your custom bagger with the Chopped Engine Guard. This guard offers a slim, low-profile design that retains function while delivering a unique styling twist. The upper mounts connect midway up the downtube, 11" inches lower than the stock guard. The minimalistic look reduces the visual mass of the bike, while the mounting point lowers the bike's visual center of gravity. The 1.25" Engine Guard features a slightly forward sweep that provides plenty of room around the brake and shift levers. Easy to install.

Fits '14-later Touring models (except Road Glide® and models equipped with fairing lowers).

49000105	Chrome.	\$289.95
49000114A	Gloss Black.	\$289.95

Fits '14-later Road Glide models (except models equipped with fairing lowers). Kit includes replacement fairing mount brackets.

49000117A	Gloss Black.	\$299.95
------------------	--------------	-----------------

F. ENGINE GUARD MOUNTING BRACKET – GLOSS BLACK

This bracket locates the steering damper and clutch cable mount when an engine guard is mounted on a FLRT model.

45700054		\$29.95
-----------------	--	----------------

Fits '15-later FLRT models.



E. CHOPPED ENGINE GUARD – CHROME
(49000105 SHOWN)



E. CHOPPED ENGINE GUARD – GLOSS BLACK
(49000117A SHOWN)



E. CHOPPED ENGINE GUARD – CHROME



F. ENGINE GUARD MOUNTING BRACKET – GLOSS BLACK



***WARNING:** Engine guards may provide limited leg and cosmetic vehicle protection under unique circumstances (fall over while stopped, very low speed slide). They are not made nor intended to provide protection from bodily injury in a collision with another vehicle or any other object.



***WARNING:** Do not use engine guard footpegs under normal stop and go operating conditions. Doing so could result in death or serious injury.



***WARNING:** Do not use highway pegs under normal stop and go operating conditions. Doing so could result in death or serious injury.

Notice: The prices appearing in this catalog are the manufacturer's suggested retail prices. Actual retail prices may vary.

386 TOURING & TRIKE

Suspension

A. PREMIUM RIDE SINGLE CARTRIDGE FORK KIT^{1,2}

The Cartridge Fork Kit complements the Premium Ride Hand-Adjustable Rear Shocks by providing a balanced suspension system capable of delivering superior ride characteristics. The front fork kit improves resistance to front brake dive, improves cornering and enhances bottoming control. The kit includes fork pipes, cartridges, fork bolts, main springs and oil seals. Available in Standard Ride Height and Low Ride Height versions.

45500158 Standard-Height. **\$349.95**
Fits '14-'16 Touring models. Does not fit Trike models.

45500157 Low-Profile. **\$349.95**
Fits '14-'16 Touring models. Does not fit Trike models. Stock on '15-'16 FLHTCUL and FLHTKL models. Must only be installed on vehicles equipped with lowered rear shocks.



A. PREMIUM RIDE SINGLE CARTRIDGE FORK KIT



B. PROFILE LOW TOURING FRONT SUSPENSION

B. PROFILE® LOW TOURING FRONT SUSPENSION^{1,2}

Original Equipment on the Electra Glide Ultra Low model, this front suspension kit reduces the front fork length by over .7", reducing seat height and delivering a closer to the pavement riding experience. This Profile® Low front suspension utilizes Dual Bending Valve technology to preserve original ride quality, and features springs that are wound to allow a compliant, yet controlled ride. When paired with the required Low Profile Hand-Adjustable Rear Suspension, the overall ride height is reduced, providing a rider with a short inseam additional confidence when stopped or maneuvering a vehicle in a parking lot. The kit includes two fork springs, two damper tubes, jiffy stand mount, seals and hardware.

45400218 **\$159.95**
Fits '17-later Touring models (except FLHTKL and '18 FLTRXSE models). Does not fit Trike models. May only be installed on FLHR, FLHRC, FLHTCU, FLHTK, FLHTKSE and FLTRU models with lowered rear shocks. Does not fit with 21" wheels.

C. PREMIUM RIDE FRONT FORK KIT – TRIKE MODELS

This Front Fork Kit provides improved handling performance by keeping the tire in contact with the road surface and features the Showa Dual Bending Valve technology. This technology increases the dampening control of the fork, equaling the finest in both comfort and control for Trike riders.

45400219 **\$429.95**
Fits '14-'18 FLHTCUTG models. Original Equipment on '19-later models.

45400220 **\$429.95**
Fits '15-'18 FLRT models. Original Equipment on '19-later models.



C. PREMIUM RIDE FRONT FORK KIT – TRIKE MODELS



D. PREMIUM RIDE DOUBLE CARTRIDGE FORK KIT

D. PREMIUM RIDE DOUBLE CARTRIDGE FORK KIT¹

The Double Cartridge Fork Kit complements the Premium Ride Hand-Adjustable Rear Shocks by providing a balanced suspension system capable of delivering superior ride characteristics. The front fork kit improves resistance to front brake dive, improves cornering and enhances bottoming control. The kit includes fork pipes, cartridges, fork bolts, main springs and oil seals.

45500106 Standard-Height. **\$429.95**
Fits '09-'13 Touring models. Does not fit Trike models.

E. PROFILE LOW TOURING FRONT LOWERING KIT^{1,2}

Place the rider's feet firmly on the ground. This kit utilizes components designed to provide a 1.0" decrease in ride height.

54564-09 **\$159.95**
Fits '09-'13 Touring models (except FLHR, FLHRC, FLHRSE, FLHXSE, FLTRSE and FLTRXSE models). Does not fit Trike models. Must only be installed on vehicles equipped with Profile® Low Touring Shocks P/N 54635-09 or Premium Ride Low Shocks P/N 54000091. Can be installed on FLHX and FLTRX models with Original Equipment rear shocks.

46875-09 **\$159.95**
Fits '09-'13 Road King® models. Must only be installed on vehicles equipped with Profile Low Touring Shocks P/N 54635-09.

54628-06 **\$159.95**
Fits '06-'08 Touring models (except Road King). Must only be installed on vehicles equipped with Profile Low Touring Shocks P/N 54631-02B. Can be installed on FLHX models with Original Equipment rear shocks.

 **¹WARNING:** Installation of any accessory suspension components may affect cornering clearance and jiffy stand operation. This could distract the rider, causing loss of control and death or serious injury.

 **²WARNING:** The Profile Low Front Suspension cannot be used independently and must be used with the appropriate lowered rear suspension kit. Installation of any accessory suspension components may affect cornering clearance and jiffy stand operation. This could distract the rider, causing loss of control and death or serious injury.



E. PROFILE LOW TOURING FRONT LOWERING KIT (46875-09 SHOWN)

Notice: The prices appearing in this catalog are the manufacturer's suggested retail prices. Actual retail prices may vary.

TOURING & TRIKE 387

Suspension



F. PREMIUM RIDE HAND-ADJUSTABLE TOURING SHOCKS

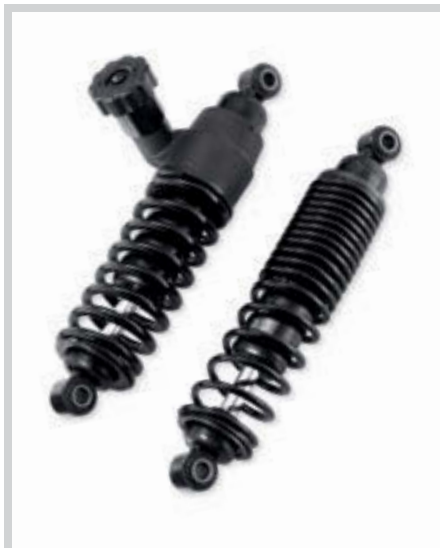

F. PREMIUM RIDE HAND-ADJUSTABLE TOURING SHOCKS*

Experience the ultimate in superior ride quality with these Premium Touring Shocks. These shocks utilize a single tube, nitrogen charged emulsion design. The design offers enhanced compression and rebound damping compared to the Original Equipment-style air adjustable shocks. This provides a controlled yet plush ride with much less bottoming. Larger chambers (40mm diameter pistons and 14mm rods) allow these shocks to react more quickly to impacts. This keeps the tires tracking while minimizing harshness transmitted through the frame. A simple knob behind the left saddle-bag allows the rider to conveniently modify the spring preload via a hydraulic adjuster. Available in Standard Ride Height and Low Ride Height versions.

54000008 Standard-Height. **\$549.95**
Fits '09-'16 Touring models (except models equipped with lowered front ends).

54000091 Low-Profile. **\$549.95**
Fits '09-'16 Touring models. Does not lower '09-'16 FLHX, FLTRX, and '09 FLTRSE models. Stock on FLHTCUL, FLHTKL, FLHXS, FLTRXS, '13 FLHRSE, '10-'12 FLHXSE, '15-'16 FLHXSE, and '12-'13 FLTRXSE models.

G. PREMIUM RIDE HAND-ADJUSTABLE TOURING SHOCKS – LOW*

Original Equipment on the Ultra Limited Low model, this low profile rear suspension system is engineered to minimize ride height while maximizing comfort for the rider and passenger. Featuring a single tube, nitrogen charged emulsion design, these shocks deliver enhanced compression and rebound damping for a controlled and comfortable ride with much less bottoming. The shocks feature large chambers that allow the suspension to react quickly to impacts, keeping the tires tracking while minimizing harshness transmitted through the frame. A simple knob behind the left saddlebag permits adjustment of the spring preload to adapt for light or heavy load. Installation of this low profile rear suspension reduces seat height by .75" to deliver a confidence-inspiring shorter reach to the ground. Kit includes left and right rear shocks.

54000159 **\$549.95**
Fits '17-later FLHR, FLHRC, FLHTCU, FLHTK, FLHTKSE and FLTRU models. Does not fit Trike models.

H. PREMIUM RIDE HAND-ADJUSTABLE SHOCKS – TRIKE MODELS

Premium Ride Hand-Adjustable Trike Shocks provide superior handling and increased comfort when riding solo or with a passenger. The easy pre-load adjuster allows for tuning based on load.

54000165 **\$799.95**
Fits '14-'18 FLHTCUTG Models. Original Equipment on '19-later models.

54000166 **\$799.95**
Fits '15-'18 FLRT Models. Original Equipment on '19-later models.

I. PROFILE® LOW TOURING AIR SHOCKS*

Lower the seat height of your Touring model without compromising the ride. The Profile® Low Touring Shocks have been re-valved for a comfortable ride while lowering the seat height by up to .75". The kit maintains the air adjustability feature of the stock shocks.

54635-09 **\$309.95**
Fits '09-'16 Touring models. Does not lower '09-'16 FLHX, FLHXS, FLTRX, FLTRXS, FLHTCUL, FLHTKL, FLHRSE, FLTRSE and FLTRXSE models. Does not fit Trike models.

54631-02B **\$339.95**
Fits '97-'08 Touring models (except '07-'08 FLHRSE). Does not lower FLHRS or FLHX models.

J. ANALOG TOURING SUSPENSION AIR PUMP

Aluminum housing is compact, lightweight, and durable, and fits easily into your bag for on-the-road adjustments. The high-quality 0-60 psi gauge ensures accurate air pressure.

54630-03A **\$52.95**
For use with Touring air suspension components.

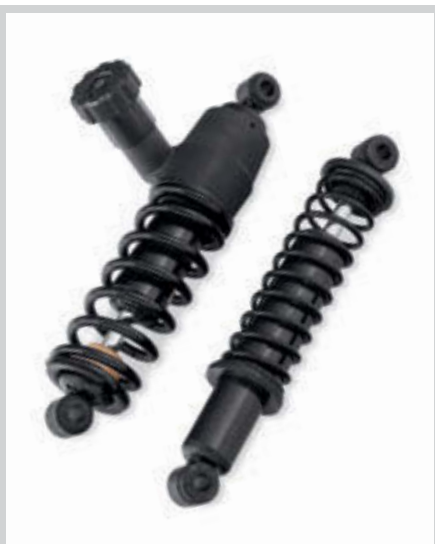

G. PREMIUM RIDE HAND-ADJUSTABLE TOURING SHOCKS – LOW

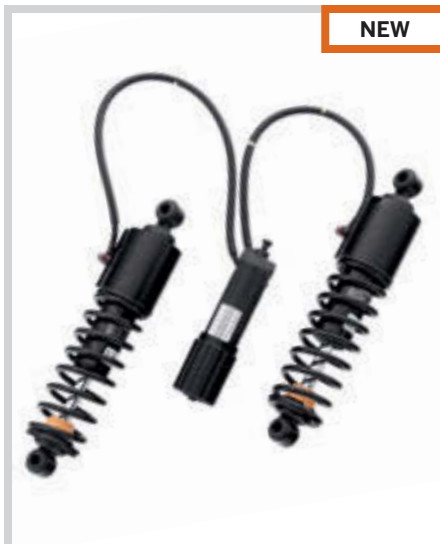

H. PREMIUM RIDE HAND-ADJUSTABLE SHOCKS – TRIKE MODELS



I. PROFILE LOW TOURING AIR SHOCKS



J. ANALOG TOURING SUSPENSION AIR PUMP



***WARNING:** Installation of any accessory suspension components may affect cornering clearance and jiffy stand operation. This could distract the rider, causing loss of control and death or serious injury.

Notice: The prices appearing in this catalog are the manufacturer's suggested retail prices. Actual retail prices may vary.

TOURING

388 TOURING & TRIKE

Suspension

A. LOWER FORK SLIDERS – CHROME

Competitively-priced, these chrome-plated Lower Fork Sliders give your bike upfront style. To ensure proper fitment and function, these sliders are manufactured from Original Equipment components. A perfect addition during the installation of Premium Ride or Profile® Low Front suspension components, the kit features polished, triple chrome-plating and stamped Harley-Davidson logo.

45500171 **\$469.95**
Fits '14-later Touring models.

45500200 **\$469.95**
Fits '14-later Trike models.

45500167 **\$469.95**
Fits '00-'13 Touring models.

83819-09 **\$469.95**
Fits '09-'13 Trike models.

B. LOWER FORK SLIDERS – GLOSS BLACK

These gloss black coated sliders are the ultimate extension of your bike's "dark side" and make a perfect custom addition to your blacked-out ride. Manufactured to Original Equipment specifications, the durable black coating is a great match to other H-D® black components. A perfect addition during the installation of Premium Ride or Profile Low front suspension components, this includes right and left sliders.

45500172B **\$464.95**
Fits '14-later Touring models.

46546-03 **\$449.95**
Fits '00-'13 Touring models.



A. LOWER FORK SLIDERS – CHROME



B. LOWER FORK SLIDERS – GLOSS BLACK

Notice: The prices appearing in this catalog are the manufacturer's suggested retail prices. Actual retail prices may vary.

TOURING & TRIKE 389

Suspension



**C. FRONT END KIT – CHROME
'14-LATER MODELS**



**D. FRONT END KIT – GLOSS BLACK
'14-LATER MODELS**



E. UPPER FORK SLIDER COVERS – CHROME



F. UPPER FORK SLIDER COVERS – GLOSS BLACK



G. UPPER FORK SLIDER COVERS – CAST CHROME



H. EDGE CUT UPPER FORK SLIDER COVERS

C. FRONT END KIT – CHROME

The front forks on a Harley-Davidson® motorcycle set the tone for the bike, and can lead the way to a full-bore custom statement. So start customizing by adding chrome where it will have the most noticeable impact on the overall look of the bike: the front end. A perfect addition during the installation of Premium Ride or Profile® Low Front suspension components. This package includes components necessary to completely chrome the front forks and includes Chrome Fork Sliders, Chrome Upper Fork Slider Covers, and Classic Chrome Front Axle Nut Covers (kit components vary depending on model).

45800037 \$589.95

Fits '14-later Touring models.

45800035 \$589.95

Fits '08-'13 Touring models (except models with ABS option).

45800034 \$589.95

Fits '08-'13 Touring models with ABS option.

45800036 \$589.95

Fits '00-'07 Touring models.

D. FRONT END KIT – GLOSS BLACK

Lead the way to the dark side. This complete blacked-out Front End Kit includes all the major components required to convert the Original Equipment satin-finished front end to a dark custom style. A perfect addition during the installation of Premium Ride or Profile® Low Front suspension components. This package includes Gloss Black Fork Sliders, Gloss Black Upper Fork Slider Covers, Gloss Black Front Axle Nut Covers, and Gloss Black Outer Fairing Skirt.

45800038B \$599.95

Fits '14-later Touring models (except Road King® and Road Glide® models)

45800022 \$589.95

Fits '08-'13 Electra Glide® and Street Glide® models.

E. UPPER FORK SLIDER COVERS – CHROME

Brilliant chrome accents for the upper fork legs. Perfect for finishing off that chromed front end look. When used with H-D® Genuine Motor Accessory Chrome Lower Fork Sliders, you've got a front end that's completely chromed and an appearance that's utterly impressive.

45600022 \$94.95

Fits '14-later Touring and Trike models.

45963-97 \$79.95

Fits '49-'84 FL, '86-'17 FLS, FLSS, FLST, FLSTC, FLSTF (except '07), FLSTFB, FLSTFBS and FLSTN and '80-'13 Touring and Trike models. Stock on FLSTNSE and FLSTSE models.

F. UPPER FORK SLIDER COVERS – GLOSS BLACK

The classic Harley-Davidson motorcycle color is black. It shows your attitude, your feelings and your desire to be different from the rest. These gloss black accessories are the ultimate extension of the Harley-Davidson philosophy. Manufactured from Original Equipment components, these parts provide superior fit and finish.

45600023 \$94.95

Fits '14-later Touring and Trike models.

45591-02 \$79.95

Fits '49-'84 FL, '86-'17 FLS, FLSS, FLST, FLSTC, FLSTF (except '07), FLSTFB, FLSTFBS, FLSTNSE and FLSTN, '10-'12 FLSTSE and '80-'13 Touring and Trike models.

G. UPPER FORK SLIDER COVERS – CAST CHROME

Add a true custom look to the front forks on your Touring ride. These one-piece cast and chrome plated upper fork covers complement both traditional and contemporary customizing styles and look great with satin finish, chrome or gloss black fork sliders.

45600032 \$189.95

Fits '14-later Touring and Trike models.

H. EDGE CUT UPPER FORK SLIDER COVERS

Add an edgy look to your front forks. These billet aluminum one-piece covers are finished in rich black and machined to expose the raw aluminum. The resulting contrasting surfaces complement both traditional and contemporary customizing styles, and look great with the Original Equipment satin-finished front end or with accessory chrome or black sliders. For a complete look, pair these covers with available edge cut wheels, controls, grips, mirrors and saddlebag latches.

45600031 \$199.95

Fits '14-later Touring and Trike models.

Notice: The prices appearing in this catalog are the manufacturer's suggested retail prices. Actual retail prices may vary.

TOURING

390 TOURING & TRIKE

Suspension Trim & Brakes

A. FORK COVER MEDALLIONS – BURST COLLECTION

These 5" medallions feature a curved mounting surface that fit perfectly to Upper Fork Slider Covers. Includes a slider cover mounting template. Easy to install. Sold in pairs.

14100434 \$64.95

Fits '49-'84 FL, '86-'17 FLST, FLSTC, FLSTF (except '07), FLSTFB, FLSTFBS and FLSTN, '10-'11 FLSTSE, '18-later FLDE, FLFB, FLFBS, FLHC, FLHCS, FLSL, and '80-later Touring and Trike models.



A. FORK COVER MEDALLIONS – BURST COLLECTION



B. FRONT FORK AIR BAFFLE – CHROME

B. FRONT FORK AIR BAFFLE – CHROME

Deflect the cold night wind rushing between the fork tubes of your Touring model. This stylish chrome air baffle replaces the Original Equipment black baffle on '00-earlier models. Includes chrome mounting hardware.

58520-79TC \$29.95

Fits '80-'13 FLHR, FLHT, FLHX and FLT models. Does not fit Trike models.

C. BRAKE CALIPER KIT – RED

Dress your bike in the latest high-performance look. Brilliant red calipers make a powerful visual statement, and set your bike apart from the ordinary. Manufactured from Original Equipment components for proven performance, these calipers will add a stylish touch to the stock bike, or add the perfect finish to a complete custom equipped with chrome or blacked-out wheels, rotors, and fork sliders.

41300116 Front – Dual Disc. \$499.95

Fits '06-'17 VRSC™, '08-later Touring and '09-'13 and '19-later Trike models. Brake pads sold separately.



C. FRONT BRAKE CALIPER KIT – RED (41300116 SHOWN)



D. FRONT BRAKE CALIPER KIT – CHROME (42012-06A SHOWN)

D. BRAKE CALIPER KIT – CHROME

Add the shine of chrome to your bike with these highly polished Chrome Brake Caliper Kits. Manufactured from Original Equipment components for proven performance, these calipers are a great addition to the stock bike, or add the finishing touch to a complete custom equipped with chrome wheels, rotors, and fork sliders.

42012-06A Front – Dual Disc. \$899.95

Fits '06-'17 VRSC, '08-later Touring and '09-'13 and '19-later Trike models. Brake pads sold separately.

44392-00A Front – Dual Disc. \$799.95

Fits '02-'05 VRSC, '00-'03 XL, '00-'07 Dyna® and '00-'07 Touring models with dual disc front brakes. Brake pads sold separately.

41300181 Front – Dual Disc. \$899.95

Fits '14-later Trike models. Brake pads sold separately.

E. CALIPER SCREEN INSERT – CHROME

These chrome-plated Caliper Inserts replace the Original Equipment satin-finish screens featured on Brembo® brake calipers. Easy pop-in installation. Sold individually.

42054-05 Front. \$29.95

Fits '06-'17 VRSC, '08-later Touring and '09-'13 and '19-later Trike models.



E. CALIPER SCREEN INSERT – CHROME



F. CALIPER SCREEN INSERT – GLOSS BLACK

F. CALIPER SCREEN INSERT – GLOSS BLACK

Complete the blacked-out transformation. Gloss black inserts replace the satin-finish screens featured on Harley-Davidson® Original Equipment Brembo brakes, and add a rich complement to the wrinkle black caliper finish. Easy pop-in installation. Sold individually.

41300154 Front. \$29.95

Fits '06-'17 VRSC, '08-later Touring and '09-'13 and '19-later Trike models.

G. FRONT WHEEL SPACERS – CHROME

There's always more room for chrome with these highly-polished chrome wheel spacers. They are manufactured to the Original Equipment tolerances, so you get exact product fitment and quality.

41371-08 Domed. \$49.95

Fits '08-later Touring models with ABS brakes.



G. FRONT WHEEL SPACERS – CHROME, DOMED

H. FRONT WHEEL SPACERS – GLOSS BLACK

It is all in the details. Complete your total front end with these wheel spacers in gloss black. Manufactured to the Original Equipment tolerances, they deliver the exact fitment and custom shine.

42400016 Domed. \$49.95

Fits '08-later Touring models with ABS brakes.



H. FRONT WHEEL SPACERS – GLOSS BLACK

Notice: The prices appearing in this catalog are the manufacturer's suggested retail prices. Actual retail prices may vary.



I. FORK AXLE RETAINER NUT KIT – CHROME

**I. FORK AXLE RETAINER NUT KIT – CHROME**

It's the details that count. Complete the chrome transformation by adding this finishing touch to your chrome fork sliders. This Axle Retainer Nut Kit includes the stylish chrome-plated nuts and chrome lockwashers necessary to replace the stock hardware.

45813-03 **\$8.95**

Fits '91-'05 FXDWG, '86-'07 FLST, FLSTC, FLSTF and FLSTN, '91-'07 FXST and FXSTB and '84-'13 Touring and Trike models.

Also available:

FORK SLIDER DRAIN SCREW KIT – CHROME

It's the details that count. Complete the chrome transformation by adding this finishing touch to your chrome fork sliders. This Fork Slider Drain Screw Kit includes two chrome-plated drain screws and the seals required to replace the stock hardware.

45848-03 **\$3.95**

Fits '93-'05 FXDWG, '87-'17 Softail® (except Springer™, FXCW, FXCWC, FXSB, FXSBSE, FXSE and FXSTD) and '87-'13 Touring and Trike models.



J. CUSTOM CALIPER BOLT COVER KIT – (40955-05 SHOWN)

**J. CUSTOM CALIPER BOLT COVER KIT**

Cover your 12-point caliper bolts in chrome. These easy-to-install chrome covers are held firmly in place with a steel spring clip, and are styled to match the Chrome Rocker Box Bolt and Headbolt Covers.

40955-05 Four Large and Two Small Covers. **\$28.95**

Fits '00-later front brake calipers (except Springer, '06-later VRSC™, '04-later XL, '15-later XG, '16-'17 FXDLS, '18-later Softail, '08-later Touring and Trike and models equipped with caliper covers). Also fits rear calipers on '06-'17 Softail models (except FXCW and FXSE).

40959-05 Three Large and Two Small Covers. **\$23.95**

Fits '00-later rear brake calipers (except Springer, '06-later VRSC, '04-later XL, '15-later XG, '16-'17 FXDLS, '18-later Softail, '08-later Touring and Trike and models equipped with caliper covers). Also fits rear calipers on '06-'17 Softail models (except FXCW, FXSE).

K. 1. BRAKE BLEEDER SCREW COVER

This cover adds chrome to the unfinished bleeder valve on all stock H-D® calipers. Package of two.

43834-98 **\$23.95**

Fits '84-later stock calipers (except XG and XR models).

2. BANJO BOLT COVER

Die-cast chrome cover provides a custom look to your stock banjo bolts. Fits banjo bolts on front and rear brake master cylinders and front and rear calipers. Installs in seconds.

32715-98 **\$21.95**

Fits '84-later models with stock master cylinders and calipers. (Does not fit VRSC Rear Master Cylinder, '06-'17 VRSC calipers, '15-later XG, '04-later XL, or '08-later Dyna, Softail, Touring and Trike models).

L. CALIPER HARDWARE KIT – CHROME

Chrome-plated hardware is a great finishing touch to Chrome Brake Calipers. This kit replaces the Original Equipment black 12-point bolts on a single caliper.

44473-02A **\$44.95**

Fits '00-'07 models (except Springer front caliper, '06-'07 VRSC, '04-'07 XL, and '06-'07 FX Softail rear calipers).

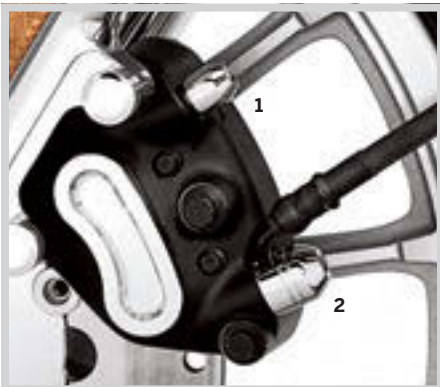

K. BLEEDER SCREW AND BANJO BOLT COVERS



L. CALIPER HARDWARE KIT – CHROME



M. BRAKE CALIPER INSERTS



N. BRAKE CALIPER TRIM DISCS

M. BRAKE CALIPER INSERTS

Easy-to-install inserts add a finishing touch to the front and rear brake calipers. Select a style that follows your custom direction. Self-adhesive backing.

Fits '00-later front and rear brake calipers on all models (except Springer front, '06-later VRSC, '15-later XG, '04-later XL, '18-later Softail rear caliper, and '08-later Touring and Trike).

1. 44477-99 Classic Chrome. **\$16.95**

2. 44476-99 Harley-Davidson Script. **\$16.95**

N. BRAKE CALIPER TRIM DISCS

Available in 1.375" and 1.75" diameters to accommodate front and rear calipers on most '99-earlier models, and front calipers on '00-later Springer models. Easy to install.

1. 44095-96 H-D Motor Co. – 1.375" Diameter. **\$16.95**

1. 44093-96 H-D Motor Co. – 1.75" Diameter. **\$16.95**

2. 99661-92T Gold Live to Ride – 1.375" Diameter. **\$16.95**

2. 99663-92T Gold Live to Ride – 1.75" Diameter. **\$16.95**

Notice: The prices appearing in this catalog are the manufacturer's suggested retail prices. Actual retail prices may vary.

392 TOURING & TRIKE

Front Axle Nut Covers

FRONT AXLE NUT COVERS

Cover the front axle in style. Available in your choice of styles, these custom Axle Nut Covers look great with Original Equipment satin-finish fork sliders or add the finishing touch to a complete chrome or blacked-out front end. Easy to install kits include all necessary mounting hardware. Sold in pairs.

Fits '02-'11 VRSC™ (except VRSCF and VRSCR), '15-later XG, '08-later XL, '08-'17 Dyna®, '07-later Softail® (except Springer™, FLSTNSE, FXCW, FXCWC, FXSB, FXSBSE, FXSE, FXST-Aus, and FXSTD) and '08-later Touring and Trike models. '18-later FLDE, FLFB, FLFBS, FLHC, FLHCS, FLSL, FXBB, FXBR, FXBRS and FXLR models require separate purchase of Front Axle Adapter Kit P/N 43000090. '19-later FXDRS and '18-later FXFB and FXFBS models require separate purchase of Front Axle Adapter Kit P/N 43000159.

A. DOMINION™ COLLECTION FRONT AXLE NUT COVERS

Express your bold, renegade attitude. The machined aluminum Dominion™ Collection Front Axle Nut Covers add style to the front of the bike and are the perfect complement to other Dominion Collection accessories.

43000124	Gloss Black.	\$74.95
43000123	Bronze.	\$74.95

B. DEFIANCE COLLECTION FRONT AXLE NUT COVERS

Start a new tradition. Deep radial grooves and a contemporary H-D logo define the style Defiance Collection Front Axle Nut Covers. Available in your choice of chrome or black machine cut finish, these easy to install elements complement polished, chrome or blacked-out front end components. Sold in pairs.

43000062	Chrome.	\$74.95
43000064	Black Machine Cut.	\$74.95

C. CHROME FRONT AXLE NUT COVERS

44117-07A	Die-cast.	\$29.95
44116-07A	Billet.	\$44.95

D. GLOSS BLACK FRONT AXLE NUT COVERS

43000026	Die-cast.	\$29.95
43428-09	Billet.	\$44.95

E. FRONT AXLE NUT COVERS – SATIN CHROME

Cover the front axle in style. The rich satin chrome finish of these Front Axle Covers is the perfect match for the satin-finished components on the '18 Fat Boy® model, and a great complement to Original Equipment polished or blacked-out fork sliders as well. Easy to install kits include all necessary mounting hardware. Sold in pairs.

43000098		\$29.95
-----------------	--	----------------

F. H-D MOTOR CO. LOGO FRONT AXLE NUT COVERS

Die-cast, chrome-plated covers feature the Harley-Davidson Motor Co. logo in black. Includes Allen®-head set screws and wrench for easy installation.

44148-07A		\$31.95
------------------	--	----------------



A. DOMINION FRONT AXLE NUT COVERS – GLOSS BLACK



A. DOMINION FRONT AXLE NUT COVERS – BRONZE

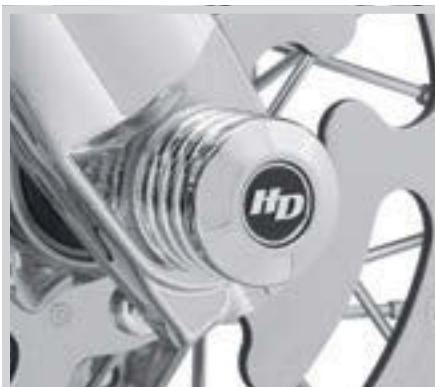

B. DEFIANCE COLLECTION FRONT AXLE NUT COVERS – CHROME



B. DEFIANCE COLLECTION FRONT AXLE NUT COVERS – BLACK MACHINE CUT



C. CHROME FRONT AXLE NUT COVERS



D. GLOSS BLACK FRONT AXLE NUT COVERS



E. SATIN CHROME FRONT AXLE NUT COVERS



F. H-D MOTOR CO. LOGO FRONT AXLE NUT COVERS

Notice: The prices appearing in this catalog are the manufacturer's suggested retail prices. Actual retail prices may vary.

TOURING & TRIKE 393

Front Axle Nut Covers



G. BURST COLLECTION FRONT AXLE NUT COVERS



H. ALUMINATOR FRONT AXLE NUT COVERS



I. WILLIE G SKULL FRONT AXLE NUT COVERS – GLOSS BLACK



I. WILLIE G SKULL FRONT AXLE NUT COVERS – CHROME



J. BRASS COLLECTION FRONT AXLE NUT COVERS



K. CHROME FRONT AXLE NUT COVERS



L. H-D MOTOR CO. LOGO FRONT AXLE NUT COVERS

G. BURST COLLECTION FRONT AXLE NUT COVERS

Finish your blacked-out forks in style. Rich black and prismatic machined surfaces provide the contrast and the race-track ridges and the inner spider design make a powerful visual statement. Easy to install kit includes mounting hardware.

43000031 \$69.95

H. ALUMINATOR® FRONT AXLE NUT COVERS

Chrome-plated billet aluminum axle covers feature a classic Bar & Shield logo insert. Includes all necessary mounting hardware for easy installation.

44114-07 \$44.95

I. WILLIE G SKULL FRONT AXLE NUT COVERS

Penned at the hand of Willie G, the famous Skull Collection adds a little attitude to your ride. Completely drenched in black or chrome with black filled accents, the raised skull and surrounding Harley-Davidson Motorcycle script adds a subtle ominous touch to your ride. The Axle Nut Covers are easy to install and include all necessary mounting hardware. Sold in pairs.

Fits '02-'11 VRSC™ (except VRSCF and VRSCR), '15-later XG, '08-later XL (except '16-later XL1200X and XL1200XS), '08-'17 Dyna®, '07-later Softail® (except Springer™, FLSTNSE, FXCW, FXCWC, FXSB, FXSBSE, FXSE, FXST-Aus, and FXSTD) and '08-later Touring and Trike models. '18-later FLDE, FLFB, FLFBS, FLHC, FLHCS, FLSL, FXBB, FXBR, FXBRS and FXLR models require separate purchase of Front Axle Adapter Kit P/N 43000090. '19-later FXDRS and '18-later FXFB and FXFBS models require separate purchase of Front Axle Adapter Kit P/N 43000159.

43000096 Black. \$34.95

43163-08A Chrome. \$34.95

J. FRONT AXLE NUT COVERS – BRASS COLLECTION

Cover the front axle in style. Artistically manufactured from solid brass, these components feature a natural antique finish that will age and patina when exposed to the elements. Brass Collection Axle Nut Covers look great with Original Equipment satin-finish fork sliders or as the finishing touch to a blacked-out front end. Easy to install kits include all necessary mounting hardware. Sold in pairs.

43000046 \$54.95

Fits '02-'11 VRSC (except VRSCF and VRSCR), '15-later XG, '08-later XL (except '16-later XL1200X and XL1200XS), '08-'17 Dyna, '07-later Softail (except Springer, FLSTNSE, FLFB, FXCW, FXCWC, FXDRS, FXFB, FXFBS, FXSB, FXSBSE, FXSE, FXST-Aus, and FXSTD) and '08-later Touring and Trike models. FLDE, FLFB, FLFBS, FLHC, FLHCS, FLSL, FXBB, FXBR, FXBRS and FXLR models require separate purchase of Front Axle Adapter Kit P/N 43000090. FXDRS, FXFB and FXFBS models require separate purchase of Front Axle Adapter Kit P/N 43000159.

K. CHROME FRONT AXLE NUT COVERS

Fits '04-'07 Dyna (except '07 FXDSE and '04-'05 FXDWG) and '00-'07 Touring models.

43062-04 Chrome – Die-cast. \$29.95

43061-04 Chrome – Billet. \$44.95

Fits '88-'07 XL, '91-'03 FXD, FXDX, FXDXT, FXDL, FXDS-CONV, '93-'05 FXDWG, '88-'07 FXR, '87-later FLXR, FXRS-SP and FXWG, '84-'06 Softail (except Springer and FXSTD) and '80-'99 Touring models.

43899-86A Chrome – Die-cast. \$29.95

L. H-D MOTOR CO. LOGO FRONT AXLE NUT COVERS

43063-04 \$29.95

Fits '04-'07 Dyna (except '07 FXDSE and '04-'05 FXDWG) and '00-'07 Touring models.

43864-96 \$31.95

Fits '88-'07 XL, '91-'03 FXD, FXDX, FXDXT, FXDL, FXDS-CONV, '93-'05 FXDWG, '88-'07 FXR, '87-later FLXR, FXRS-SP and FXWG, '84-'06 Softail (except Springer and FXSTD) and '80-'99 Touring models.

Notice: The prices appearing in this catalog are the manufacturer's suggested retail prices. Actual retail prices may vary.

394 TOURING & TRIKE

Fairing Trim

A. OIL COOLER COVER

Dress the Touring oil cooler in style. This Oil Cooler Cover is designed to hug the contours of the cooler body and does not interfere with the engine guard or voltage regulator. The forward-facing mesh screen adds a custom touch, and protects the oil cooler fins from road debris without disturbing the airflow across the surface. Available in your choice of chrome or gloss black finish, the easy-to-install cover kit includes all required mounting hardware.

Fits '17-later FLHR, FLHRC, FLHX, FLHXS, FLTRX and FLTRXS models. Does not fit models equipped with fairing lowers. Does not fit with Fan-Assisted Oil Cooler P/N 62700204.

25700633	Chrome.	\$149.95
25700634	Gloss Black.	\$149.95



A. OIL COOLER COVER – CHROME



A. OIL COOLER COVER – GLOSS BLACK

B. OIL COOLER COVER KIT – CHROME

Dress the Touring Oil Cooler in style. This Chrome Oil Cooler Cover is designed to hug the contours of the cooler body while allowing complete airflow across the surface. Includes required mounting hardware.

25700007		\$59.95
-----------------	--	----------------

Fits '09-'10 Touring and Trike models.

63121-11A		\$59.95
------------------	--	----------------

Fits '11-'16 Touring and Trike models (except models equipped with Twin-Cooled™ engines).



B. OIL COOLER COVER KIT – CHROME
'09-'10 TOURING



B. OIL COOLER COVER KIT – CHROME
'11-'16 TOURING

C. WATER PUMP COVER – CHROME

Dress the Twin-Cooled™ Touring model's Water Pump Cover in style. This Chrome Water Pump is designed to hug the contours of the water pump, and conceals many of the coolant lines and fittings for a custom look. A direct replacement for the Original Equipment black plastic cover, this kit can be installed in minutes.

61400225		\$74.95
-----------------	--	----------------

Fits '14-'16 FLHTCU, FLHTCUL, FLHTK, FLHTKL, FLHTKSE, FLTRU, FLTRUSE and FLHTCUTG models equipped with Twin-Cooled engines.



C. WATER PUMP COVER – CHROME

Notice: The prices appearing in this catalog are the manufacturer's suggested retail prices. Actual retail prices may vary.

TOURING & TRIKE 395

Custom Bagger – Bodywork

D. CUSTOM REAR FENDER SYSTEM – PRIMED

Complete with integrated LED brake lights, turn indicators and tail lights, this custom rear fascia and fender kit keeps the back of your bike clean, classy and simple. Originally featured on CVO™ Touring models, this kit includes everything you need to smoothly blend the shape of the rear fender into the saddlebags and hide the saddlebag mounting structure.

Fits '14-later Touring (except FLHRC, and CVO models). Does not fit models equipped with Saddlebag Guard Rails P/N 90200561.

59500246 Domestic (US-only) **\$999.95**

59500245 International (Australia, Brazil, Canada, Europe, Japan and Mexico) **\$999.95**

Fits '09-'13 Touring models (except FLHRC). FLHTC and FLHTCU models require separate purchase of Saddlebag Support Kit P/N 90881-09.

59500105BEO Domestic. **\$999.95**



D. CUSTOM REAR FENDER SYSTEM – WITH CUSTOM VIVID BLACK PAINT – '14-LATER DOMESTIC MODELS



D. CUSTOM REAR FENDER SYSTEM – '14-LATER DOMESTIC MODELS



D. CUSTOM REAR FENDER SYSTEM – '14-LATER INTERNATIONAL MODELS



D. CUSTOM REAR FENDER SYSTEM – '09-'13 DOMESTIC MODELS

TOURING

Notice: The prices appearing in this catalog are the manufacturer's suggested retail prices. Actual retail prices may vary.

396 TOURING & TRIKE

Headlamp Trim

A. GLOSS BLACK NACELLE AND HANDLEBAR COVER KIT

The classic Harley-Davidson® motorcycle color is black. It shows your attitude, your feelings and your desire to be different from the rest. Take the blacked-out look to the next level with this special gloss black Headlamp Nacelle. The bold black finish adds to the classic locomotive visual effect and visually stretches the profile of the Road King® model. Manufactured from Original Equipment components for superior fit and finish, the complete kit includes nacelle housing, handlebar cover, nacelle spear, and headlamp trim ring.

61300875 **\$524.95**
Fits '14-later FLHR and FLHRC models.

B. STREET GLIDE® FRONT BULLET TURN SIGNAL MOUNT KIT – GLOSS BLACK

Complement the lean, stripped-down look of your Street Glide® model. Manufactured from Original Equipment components, these rich gloss black Turn Signal Mounts replace the factory-installed chrome mounts to complete the blacked-out look. The brackets serve as stylized mounting points for the Original Equipment or accessory LED bullet turn signals, and conceal the wiring for a clean, custom appearance. Kit includes left and right mounting bracket.

67800706 **\$99.95**
Fits '14-later FLHX, FLHXS and FLHXSE models.

C. ROAD GLIDE® FRONT BULLET TURN SIGNAL MOUNTS – GLOSS BLACK

Complete the sinister look of your Road Glide® model. Manufactured from Original Equipment components, these rich gloss black Turn Signal Mounts replace the factory-installed chrome mounts, and continue the blacked-out look. The brackets serve as stylized mounting points for the Original Equipment or accessory LED bullet turn signals, and are the perfect complement to Gloss Black Fairing Support P/N 47200278, a gloss black engine guard and gloss black front end components. Kit includes right and left hand mounts.

67800707 **\$69.95**
Fits '15-later Road Glide models.



A. GLOSS BLACK NACELLE AND HANDLEBAR COVER KIT



B. STREET GLIDE FRONT BULLET TURN SIGNAL MOUNT KIT – GLOSS BLACK



C. ROAD GLIDE FRONT BULLET TURN SIGNAL MOUNTS – GLOSS BLACK

Notice: The prices appearing in this catalog are the manufacturer's suggested retail prices. Actual retail prices may vary.

TOURING & TRIKE 397

Fairing Trim



D. TIE-DOWN BRACKETS – CHROME



D. TIE-DOWN BRACKETS – '14-LATER MODELS



D. TIE-DOWN BRACKETS – '95-'13 MODELS



E. OUTER FAIRING SKIRT – GLOSS BLACK



E. OUTER FAIRING SKIRT – '14-LATER MODELS



E. OUTER FAIRING SKIRT – '00-'13 MODELS



F. ROAD GLIDE FAIRING SUPPORT KIT – GLOSS BLACK



D. TIE-DOWN BRACKETS – CHROME

Simplify the process of securing your bike to a trailer or bike lift. These stylish chrome Tie-Down Brackets mount cleanly to the front fork cover and offer a secure method to connect tie-down straps. Moving the tie-down point from the handlebar to the triple-tree area reduces wear on the handlebar bushings and ensures a consistent easy-to-access mounting point. Just add Harley-Davidson® Ratchet Straps and Soft Hooks and you're ready to go.

93500011 **\$64.95**
Fits '14-later Touring models (except Road Glide® and Road King®). Does not fit Trike models.

93500006 **\$64.95**
Fits '02-'17 FLS, FLSS, FLSTC, FLSTF, FLSTFB and FLSTFBS, '95-later FLHR, FLHRC and FLHRXS, '95-'13 FLHT, FLHTC and FLHX, '10-'13 FLHTCU and FLHTK, '10-'12 FLHXSE and '09-'12 FLHTCUSE. FLS, FLSS, FLSTF, FLSTFB and FLSTFBS models without a windshield require separate purchase of Hardware Kit P/N 91800030.

E. OUTER FAIRING SKIRT – GLOSS BLACK

Add a sinister touch to your batwing fairing. This classic gloss black skirt replaces the Original Equipment chrome or color-matched trim below the headlamp. The black skirt visually slims the fairing, and is the ideal finishing element on a blacked-out bike. Manufactured from Original Equipment components for superior fit and finish.

57100227 **\$64.95**
Fits '14-later Electra Glide®, Street Glide® and Ultra Limited models.

46559-03 **\$99.95**
Fits '00-'13 FLHT, FLHTC, FLHTCU, FLHTK and FLHX models. Does not fit Trike models.

F. ROAD GLIDE® FAIRING SUPPORT KIT – GLOSS BLACK

Take your Road Glide in a different direction. Easy to install Fairing Mount replaces the Original Equipment chrome edition, and forms a seamless gloss black transition between a black engine guard and a dark color fairing. Kit includes gloss black left and right fairing support and matching engine guard clamps.

47200278 **\$169.95**
Fits '15-later Road Glide models.

398 TOURING & TRIKE

Fender Trim

A. FL TOURING CLEAN FRONT FENDER

With no holes, this fender provides the starting point for customization. Offered in primed finish and ready to bolt onto existing brackets.

59045-00B **\$299.95**

Fits '94-'13 FLHR and '89-'13 FLHT and FLT models.

B. STREET STALKER® FRONT FENDER KIT*

The smooth curves of the Street Stalker® Front Fender easily create a clean, custom front-end look. Made from high-impact, injection-molded composite materials. Includes mounting hardware.

Fits '86-'17 FL Softail® models (except Springer™). Also fits '00-later Touring models (except models equipped with fairing lowers and '13-later Road Glide® models) with separate purchase of Fender Adaptor Kit P/N 59013-02A or P/N 58900085A. Does not fit Trike models.

59397-03DH **\$199.95**

C. FRONT FENDER ADAPTER KIT

Add a true custom style to your Touring model. This polished and chrome-plated Adapter Kit will allow you to install the smooth curving Fat Boy® or Street Stalker front fender on your Touring bike. Manufactured from 6061-T6 billet aluminum, this kit includes all necessary mounting hardware. See your Dealer for primed or Color-Matched fender options.

58900085A **\$99.95**

Fits '14-later Touring models (except models equipped with fairing lowers). Does not fit Trike models.

D. VOLTAGE REGULATOR COVER – CHROME

This chrome-plated steel cover features an open-faced design to allow airflow through the voltage regulator. Chrome-plated mounting hardware included.

74538-09 **\$44.95**

Fits '09-'13 Touring (except models with oil coolers). Will not fit models equipped with a sidecar.

74543-00 **\$44.95**

Fits '97-'08 Electra Glide®, Road Glide and Road King® (except models with oil coolers). Will not fit '07-later models equipped with a sidecar.



A. FL TOURING CLEAN FRONT FENDER



B. STREET STALKER FRONT FENDER KIT – VIVID BLACK



C. FRONT FENDER ADAPTER KIT – '14-LATER MODELS



D. VOLTAGE REGULATOR COVER – CHROME ('97-'08 MODELS SHOWN)



D. VOLTAGE REGULATOR COVER – CHROME ('09-'13 MODELS SHOWN)



D. VOLTAGE REGULATOR COVER – CHROME ('97-'08 MODELS SHOWN)

Notice: The prices appearing in this catalog are the manufacturer's suggested retail prices. Actual retail prices may vary.

TOURING & TRIKE 399

Fender Trim



E. FRONT FENDER TRIM KIT – CHROME

E. FRONT FENDER TRIM KIT – CHROME

Replace the Original Equipment stainless steel fender trim with a splash of chrome. Kit includes left and right side trim strip.

59209-91T **\$29.95**
Fits '86-'17 FLSTC and FLSTN and '82-'13 Touring models (except Road Glide® and Road King® Custom). Does not fit models equipped with clean front fender.

F. AIR WING FRONT FENDER RAIL*

Shaped by the wind, this aerodynamic front fender rail features an inverted-wing tip and support rails that complement the sweeping lines of the fender. As a stylish replacement for the traditional rubber bumper and rails, the completed installation mirrors the design of the Original Equipment fender tip and spears. The hidden hardware adds to the clean, custom appearance. The mirror chrome surface and embossed Harley-Davidson lettering finishes the look.

59600022 **\$99.95**
Fits '14-later FLHTCU, FLHTCUL, FLHTK and FLHTKL models.

G. ELECTRA GLIDE® SPORT AND ROAD KING® FRONT BUMPER ASSEMBLY*

Add style and protection to the front fender of your Electra Glide® Sport or Road King motorcycle.

91085-83D **\$139.95**
Fits '94-'13 FLHR, '87-'93 FLHS and '96-'13 FLHT models. Does not fit Trike models.

H. V-LOGO FRONT FENDER RAIL*

A stylish re-creation of a popular Hydra Glide accessory, this twin tube design sweeps smartly back along the front fender. Matching Touring V-Logo Rear Fender Rail P/N 91100-94 integrates the styling from front to rear. Includes mounting hardware and installation instructions.

91099-94A **\$99.95**
Fits '80-'13 FLHR, FLHRC, FLHT, FLHTC, FLHTCU, FLHTK and FLT, '80-'93 FLHS and '09-'13 FLHTCUTG models.

I. V-LOGO REAR FENDER RAIL*

Designed with a similar styling theme to match our Touring V-Logo Front Fender Rail P/N 91099-94A. Replaces the stock rear fender rail and rubber bumper on Touring models. Chrome-plated twin tubes are crowned with a hand-polished and chrome-plated cast V-Logo reminiscent of the Harley-Davidson® 1953 Golden Anniversary medallion. Includes hardware and installation instructions.

91100-09 **\$99.95**
Fits '09-later FLHR, FLHRC, FLHRXS, FLHT, FLHTC, FLHTCU, FLHTCUL, FLHTK, FLHTKL, FLTR and FLTRU models. Does not fit with mud flaps.



F. AIR WING FRONT FENDER RAIL



F. AIR WING FRONT FENDER RAIL



G. ELECTRA GLIDE SPORT AND ROAD KING FRONT BUMPER ASSEMBLY



H. V-LOGO FRONT FENDER RAIL



I. V-LOGO REAR FENDER RAIL

***WARNING:** Fender rails are decorative items only. Do not strap anything to the rails. Adding any additional weight to the front fender could adversely affect vehicle handling, causing loss of control and death or serious injury.

Notice: The prices appearing in this catalog are the manufacturer's suggested retail prices. Actual retail prices may vary.

TOURING

400 TOURING & TRIKE

Fender Trim

A. FRONT FENDER RAIL AND STANCHION KIT*

Chrome-plated accents straight from our 1947 catalog. Includes template for easy installation.

91117-97 **\$69.95**

Fits '84-'17 FL Softail® (except FLS, FLSS, FLSTF, FLSTFB, FLSTFBS, FLFTNSE, FLSTSB and FLSTSE), '18-later Softail FLDE, FLHC and FLHCS, '84-later Touring (except FLHRXS), and Trike models.

B. FRONT FENDER TRIM

Add a sweeping dash of chrome to the front fender. Chrome-plated tapered spear features a stepped design that accentuates the flowing fender lines. Self-adhesive backing simplifies installation.

14100618 **\$44.95**

Fits '12-'16 FLD, '86-'17 FL Softail (except FLSTSB), '18-later Softail FLDE, FLHC and FLHCS, '84-later Touring and Trike models.

C. BAR & SHIELD LOGO FRONT FENDER SPEAR

This chrome-plated trim spear adds a sweeping dash of chrome to the front fender. Featuring a raised Bar & Shield logo set against a textured black field, this self-adhesive medallion is easy to install.

91195-04 Large. **\$44.95**

Fits '12-'16 FLD, '86-'17 FL Softail (except FLSTSB), '18-later Softail FLDE, FLHC and FLHCS, '84-later Touring and Trike models.

D. BAR & SHIELD FENDER TIP LENS KIT

Chrome-plated polycarbonate construction features translucent Bar & Shield emblems. The kit includes front and rear lenses. Front lens features an amber Bar & Shield, rear lens features a red Bar & Shield. Quick and easy installation.

59081-96 Front and Rear. **\$29.95**

Fits '86-'17 FLSTC, '93-'96 FLSTN and '80-'08 FLHR, FLHS, FLHT and FLT models. (Does not fit Springer™, FLHRS or FLTR models.)

E. FENDER TIP LENS KIT WITH SKULL LOGO

This chrome-plated Fender Tip Lens Kit adds a little attitude to your ride. The kit features front and rear lenses with a translucent illuminated skull silhouette. The easy-to-install kit includes an amber front lens and red rear lens.

59651-01 **\$29.95**

Fits '86-later FLSTC, '93-'96 FLSTN and '80-'08 Electra Glide®, Tour Glide™ and Road King® models (except FLHC and FLHRS).

F. H-D® CLASSIC FENDER TIP

Stock on Road King Classic models, these nostalgic-look fender tips are also available for other models. Replaces fender lamp assembly.

59002-98 Front. **\$31.95**

Fits '80-'13 FL, '86-'08 FLSTC, '94-'13 FLHR and '09-'13 FLHTCUTG models.

59052-98 Rear. **\$31.95**

Fits '80-'08 FL and FLHR models and '86-'99 FLSTC models. (Does not fit FLSTF and FLTR models.)



A. FRONT FENDER RAIL AND STANCHION KIT



B. FRONT FENDER TRIM KIT



C. BAR & SHIELD LOGO FRONT FENDER SPEAR



D. BAR & SHIELD FENDER TIP LENS



E. FENDER TIP LENS WITH SKULL LOGO



F. H-D CLASSIC FENDER TIP



F. H-D CLASSIC FENDER TIP



***WARNING:** Fender rails are decorative items only. Do not strap anything to the rails. Adding any additional weight to the front fender could adversely affect vehicle handling, causing loss of control and death or serious injury.

Notice: The prices appearing in this catalog are the manufacturer's suggested retail prices. Actual retail prices may vary.

TOURING & TRIKE 401

Fender Trim



G. FRONT FENDER SKIRT – CHROME



G. FRONT FENDER SKIRT – GLOSS BLACK

G. FRONT FENDER SKIRT

Designed as an easy-to-install replacement for the Original Equipment fender trim, this formed steel fender skirt features four raised accent ribs that wrap around the rear to add depth and texture. Available in your choice of mirror-finished chrome or gloss black finishes, the skirt is the perfect complement to any styling direction. And for a distinctive look, the flat side panels are the perfect spot to place your choice of self-adhesive medallions (sold separately). Kit includes mounting hardware.

Fits '14-later Touring and Tri Glide® models with Original Equipment fender skirts.

61400312	Chrome.	\$39.95
61400311	Gloss Black.	\$39.95



**H. FENDER SKIRT MEDALLIONS
(BAR & SHIELD SHOWN)**



H. FENDER SKIRT MEDALLIONS

H. FENDER SKIRT MEDALLIONS

Personalize your fender skirts or almost any flat surface. These heavy-weight cast three-dimensional medallions add a distinctive look to your ride, and complement other available Harley® accessory collections. Self-adhesive backing holds the medallion firmly in place. Medallions are approximately 1.5" diameter. Sold in pairs.

14100747	Bar & Shield.	\$24.95
14100748	Classic H-D.	\$24.95
14100749	Willie G Skull.	\$24.95

I. CONCHO FENDER SKIRT

This decorative fender skirt features conchos inspired by the Heritage Softail® Classic motorcycle.

59147-96 **\$59.95**

Fits '06 FLST, '86-'08 FLSTC, '93-'96 FLSTN, '80-'13 Touring and '09-'13 Trike models equipped with Original Equipment fender skirt.

J. WILLIE G SKULL FENDER SKIRT

This decorative chrome-plated fender skirt is a direct replacement for stock fender skirt. Features a three-dimensional sculptured concho with skull design set off with black accents. Mounting hardware included.

59582-02A **\$59.95**

Fits '06 FLST, '86-'08 FLSTC, '93-'96 FLSTN, '80-'13 Touring and '09-'13 Trike models equipped with Original Equipment fender skirt.



I. CONCHO FENDER SKIRT



J. WILLIE G SKULL FENDER SKIRT

K. BAR & SHIELD FENDER SKIRT

This rigid-steel fender skirt, designed to replace the original factory-equipped aluminum trim, is formed, polished, and chrome-plated. Its ribbed pattern offers a unique styling element and adds rigidity. Subtle but distinctive brushed aluminum Bar & Shield logos are framed by a stamped-in ribbed outline on both sides.

59228-91 **\$59.95**

Fits '06 FLST, '86-'08 FLSTC, '93-'96 FLSTN, '80-'13 Touring and '09-'13 Trike models equipped with Original Equipment fender skirt.

L. ROAD KING® CLASSIC FENDER SKIRT

The latest in the family of Road King-inspired accessories, this chrome-plated steel fender skirt features four raised accent ribs and a die-cast Road King® Classic medallion in chrome with black accents. Mounting hardware included.

59005-98 **\$59.95**

Fits '80-'13 Touring and '09-'13 Trike models equipped with Original Equipment fender skirt.



K. BAR & SHIELD FENDER SKIRT



L. ROAD KING CLASSIC FENDER SKIRT

Notice: The prices appearing in this catalog are the manufacturer's suggested retail prices. Actual retail prices may vary.

402 TOURING & TRIKE

Fairing Trim

A. INNER FAIRING TRIM KIT

Add a touch of luxury and style to your dash. This complete kit dresses the inner fairing by surrounding the radio faceplate and front speakers with chrome. Self-adhesive bezels surround the gauges and the gloss black fascia completes the stylish look. Kit includes Gauge Trim Kit, Radio Faceplate Trim and two Front Speaker Trim Rings.

61400199 **\$149.95**

Fits '14-later Electra Glide®, Street Glide®, Ultra Limited and Tri Glide® models. Does not fit CVO™ models or models equipped with accessory Boom!™ Audio Fairing Speakers.

B. GAUGE TRIM KIT – CHROME

A touch of chrome makes all the difference. These classic gauge bezels take just a few minutes to install, and add the beauty of chrome to your dash. Trim rings are formed to the gauge shapes and feature peel-and-stick adhesive backing for permanent installation. No back plate is required for installation. The 4-piece kit includes two large and two small gauge bezels.

61400451 **\$89.95**

Fits '14-later Electra Glide, Street Glide, Ultra Limited and Tri-Glide Models. Fits with '18-later CVO backplate. Does not fit with Gauge Trim P/N 61400328.

C. RADIO TRIM BEZEL

This chrome faceplate trim accents the center section of the inner fairing and highlights the radio. Trim is formed to the inner fairing and feature peel-and-stick adhesive backing for simple, permanent installation.

61400201 **\$27.95**

Fits '14-later Electra Glide, Street Glide, Ultra Limited and Tri Glide models.



A. INNER FAIRING TRIM KIT



A. INNER FAIRING TRIM KIT



B. GAUGE TRIM KIT – CHROME

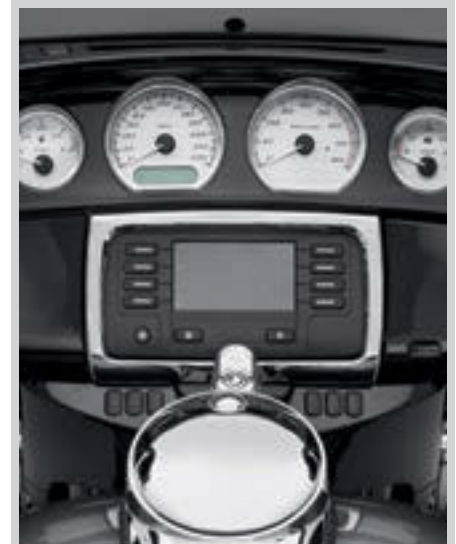

C. RADIO TRIM BEZEL

Notice: The prices appearing in this catalog are the manufacturer's suggested retail prices. Actual retail prices may vary.

TOURING & TRIKE 403

Fairing Trim



**D. INNER FAIRING TRIM KIT
(SHOWN WITH FAIRING DASH PAD)**

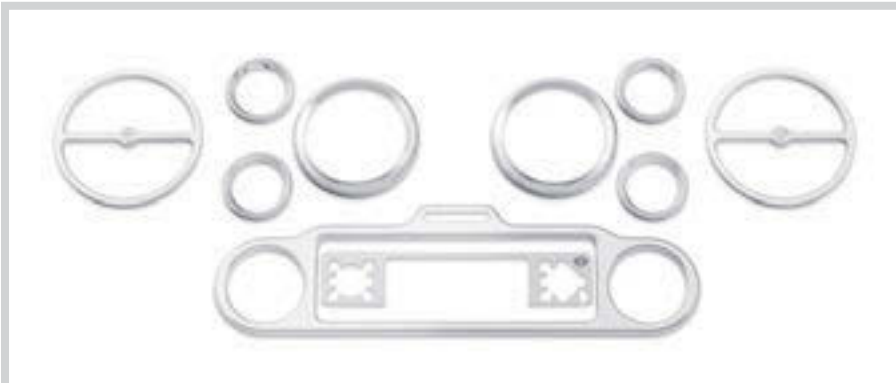

D. INNER FAIRING TRIM KIT

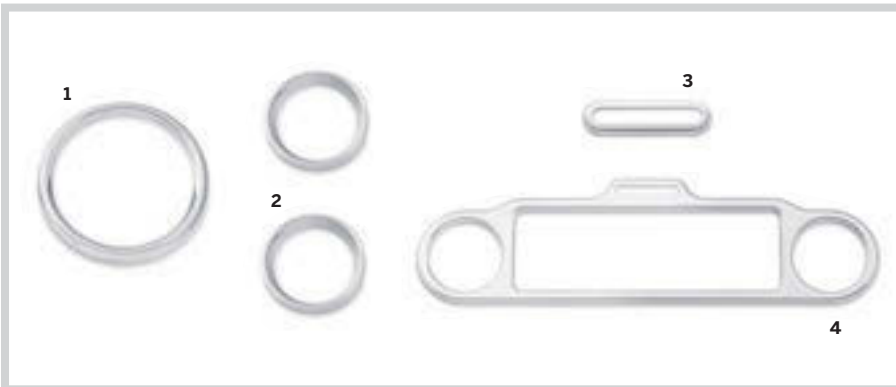

E. CHROME INSTRUMENT BEZELS



F. RADIO FACEPLATE TRIM

D. INNER FAIRING TRIM KIT

Add a touch of luxury and style to your dash. This complete kit dresses the inner fairing by surrounding the radio faceplate and gauges with chrome. Package includes: Bar & Shield Radio Faceplate, two 4.0" Speedo/Tach Gauge Bezels, four 2.0" Gauge Bezels, Radio and Gauge Faceplate Trim and two Front Speaker Trim Rings.

96396-09 **\$119.95**
Fits '06-'13 Electra Glide®, Street Glide® and Trike models equipped with the Advanced Audio System Radio.

E. CHROME INSTRUMENT BEZELS

A touch of chrome makes all the difference. These bezel covers take just seconds to install and add the beauty of chrome to your dash. Available to fit all the fairing-mount gauges, these easy-to-install, chrome-plated formed rings feature peel-and-stick adhesive backing for permanent installation.

1. 4" Chrome Gauge Bezel

74541-00 **\$16.95**
Fits Speedometer and Tachometer Gauges on '00-later XL, '00-'13 Dyna® (except FLD and FXDWG), '13-'17 FXSB, FXSBSE, and FXST-Aus, and '00-'13 Electra Glide, Street Glide, Road Glide® and Trike Models. Sold individually.

2. 2" Chrome Gauge Bezel

74550-92T **\$18.95**
Fits Voltmeter, Oil Pressure, Air Temp and Fuel Gauge on '86-'13 Electra Glide, Street Glide, Road Glide and Trike models. Sold in pairs.

3. Chrome Indicator Lamp Bezel Cover

74562-98 **\$16.95**
Fits '96-'13 Electra Glide, Street Glide and Trike models.

4. Radio and Gauge Faceplate Trim

74612-06 **\$28.95**
Fits '96-'13 Electra Glide, Street Glide and Trike models.

F. RADIO FACEPLATE TRIM

This brushed aluminum radio faceplate features self-adhesive installation on any model equipped with the Advanced Audio System Radio.

77143-07 Bar & Shield. **\$16.95**
Fits '06-'13 Touring models equipped with Advanced Audio System Radio.

404 TOURING & TRIKE

Fairing Trim

A. INNER FAIRING TRIM KIT – ROAD GLIDE®

Add a touch of luxury and style to your dash. This complete kit dresses the inner fairing by surrounding the gauges, radio faceplate and front speakers with chrome. Self-adhesive bezels are easy to install, and add a brilliant finish to matte or gloss finish inner fairings. The 6-piece kit includes the Gauge Trim Kit, Radio Faceplate Trim and two Front Speaker Trim Rings.

61400296 6-Piece Kit. **\$149.95**
Fits '15-later Road Glide® models (except FLTRUSE). Does not fit models equipped with Boom!™ Audio Fairing Speakers.

B. GAUGE TRIM KIT – ROAD GLIDE

A touch of chrome makes all the difference. The classic gauge bezels take just a few minutes to install, and add the beauty of chrome to your dash. Trim rings are formed to the gauge shapes and feature peel-and-stick adhesive backing for permanent installation. The 3-piece kit includes speedo/tach pod surround and 2 auxiliary gauge trim rings.

61400299 3-Piece Kit. **\$79.95**
Fits '15-later Road Glide models.

C. RADIO TRIM BEZEL – ROAD GLIDE

This chrome faceplate trim accents the center section of the inner fairing and highlights the radio. Trim is formed to the radio surround and feature peel-and-stick adhesive backing for simple, permanent installation.

61400298 **\$39.95**
Fits '15-later Road Glide models.

D. SPEAKER TRIM – ROAD GLIDE

When it comes to style, this chrome-plated trim makes your speakers look as good as they sound. These bezels mount directly over the Original Equipment speaker grills, and add a subtle spot of chrome. Easy to install, the kit includes left and right speaker trim.

61400297 **\$49.95**
Fits '15-later Road Glide models (except FLTRUSE). Does not fit models equipped with Boom! Audio Fairing Speakers.

E. ROAD GLIDE FAIRING SPEAKER GRILL

Streamline the appearance of the Road Glide model's inner fairing. Easy-to-install snap-in perforated metal speaker grill features a smooth face for a clean, custom look. Kit includes left and right speaker grills and replacement gaskets.

76000735 **\$74.95**
Fits '15-later FLTRX, FLTRXS and FLTRU models.



A. INNER FAIRING TRIM KIT – ROAD GLIDE



A. INNER FAIRING TRIM KIT – ROAD GLIDE



B. GAUGE TRIM KIT – ROAD GLIDE



C. RADIO TRIM BEZEL – ROAD GLIDE



D. SPEAKER TRIM – ROAD GLIDE



E. ROAD GLIDE FAIRING SPEAKER GRILL

Notice: The prices appearing in this catalog are the manufacturer's suggested retail prices. Actual retail prices may vary.

TOURING & TRIKE 405

Fairing Trim



F. SPEAKER TRIM – FRONT
'14-LATER MODELS



F. SPEAKER TRIM – REAR
'14-LATER MODELS



F. SPEAKER TRIM – FRONT
'96-'13 MODELS



F. SPEAKER TRIM – REAR
'98-'13 MODELS



G. BOOM! AUDIO STAGE I SPEAKER TRIM – FRONT, '14-LATER MODELS



G. BOOM! AUDIO STAGE I SPEAKER TRIM – REAR, '14-LATER MODELS



G. BOOM! AUDIO STAGE I SPEAKER TRIM – FRONT, '98-'13 MODELS



G. BOOM! AUDIO STAGE I SPEAKER TRIM – REAR, '98-'13 MODELS

F. SPEAKER TRIM – CHROME

When it comes to style, this chrome-plated trim makes your speakers look as good as they sound. These bezels mount directly over the Original Equipment speaker grills, and add a subtle spot of chrome. Easy to install, the kit includes left and right speaker trim and required mounting supplies.

61400197 Front. **\$39.95**
Fits '14-later Electra Glide®, Street Glide®, Ultra Limited and Tri Glide® models with Original Equipment speakers. Does not fit FLHTKSE models or models equipped with Boom!™ Audio High Performance Speakers.

61400194 Rear. **\$39.95**
Fits '14-later FLHTCU, FLHTCUL, FLHTK, FLHTKL, FLTRU and FLHTCUTG models with Original Equipment Tour-Pak® speakers. Does not fit FLHTKSE, FLTRUSE or models equipped with Boom! Audio High Performance Speakers.

74604-99 Front. **\$32.95**
Fits '96-'13 Electra Glide, Street Glide and Trike models with Original Equipment Speaker Grills. Does not fit '11-'13 FLHXSE, '12-'13 FLHTCUSE or models equipped with Boom! Audio High Performance Speakers.

74584-99 Rear. **\$35.95**
Fits '98-'13 FLHTCU, FLHTK and FLHTCUTG models. Does not fit '12-'13 FLHTCUSE or models equipped with Boom! Audio High Performance Speakers.

G. BOOM!™ AUDIO STAGE I SPEAKER TRIM

Add a touch of chrome to your Boom! Audio Speakers. Chrome trim rings outline the speaker and accent the rich black speaker grill. Easy to install, the trim rings complement available chrome fairing trim. Sold in pairs.

61400193 Front. **\$44.95**
Fits '14-later Electra Glide, Street Glide, Ultra Limited and Tri Glide models with Boom! Audio Stage I Fairing Mount Speakers.

61400210 Rear. **\$44.95**
Fits '14-later Electra Glide, Street Glide, Ultra Limited, Road Glide® Ultra and Tri Glide models with Rear Speaker Pods and Boom! Audio Stage I Tour-Pak Rear Speakers.

76000156 Front. **\$39.95**
Fits '98-'13 Electra Glide, Street Glide and Trike models equipped with Boom! Audio Fairing Mount Speakers.

76000157 Rear. **\$39.95**
Fits '98-'13 Touring models with Rear Speaker Pods and Boom! Audio Tour-Pak Rear Speakers.

406 TOURING & TRIKE

Fairing Trim

A. DEFIANCE COLLECTION GAUGE BEZEL TRIM

The perfect finishing touch. Defiance Collection Gauge Bezels add a custom detail to the place you constantly look – your instrument cluster. Accented with deep grooves, these machined aluminum rings cover the factory gauge surround adding texture and visual interest to the dash. Available in chrome, gloss black or machine cur black finishes, these self-adhesive rings are easy to install.

Fits '14-later Electra Glide®, Road Glide®, and Tri Glide® models.

61400359 4-Piece Fairing Kit – Chrome. **\$149.95**

61400361 4-Piece Fairing Kit – Black Machine Cut. **\$164.95**

61400360 4-Piece Fairing Kit – Black Anodized. **\$149.95**

Fits '99-later XL (except XL1200CX, XL1200X and XL1200XS), '11-'13 FXS, '13-'17 FXSB, '13-'14 FXSBSE, '98-'13 Road Glide, '14-'17 FXDL, and '18-later FXFB, FXFBS and FXLR models.

61400435 4" Tank Gauge – Chrome. **\$69.95**

61400436 4" Tank Gauge – Black Machine Cut. **\$74.95**

61400437 4" Tank Gauge – Black Anodized. **\$69.95**

Fits '18-later FLDE, FLHC, FLHCS, and FLSL models.

61400438 5" Tank Gauge – Chrome. **\$54.95**

61400439 5" Tank Gauge – Black Machine Cut. **\$59.95**

61400440 5" Tank Gauge – Black Anodized. **\$54.95**

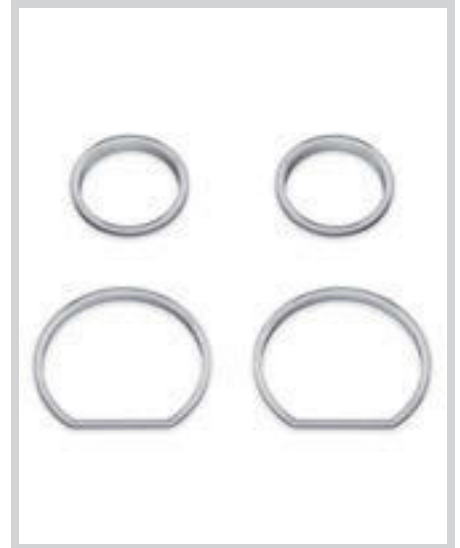

A. DEFIANCE COLLECTION GAUGE BEZEL TRIM – CHROME



A. DEFIANCE COLLECTION GAUGE BEZEL TRIM – BLACK MACHINE CUT

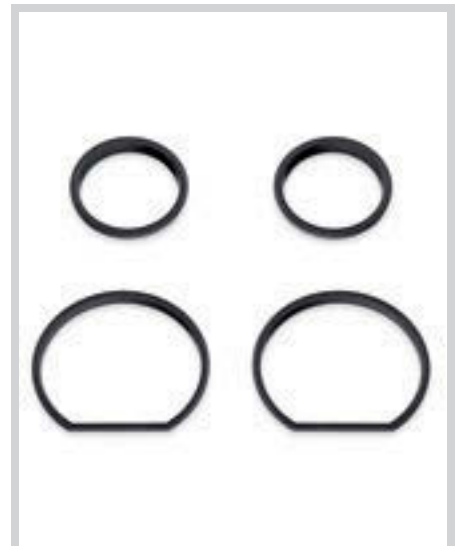

A. DEFIANCE COLLECTION GAUGE BEZEL TRIM – BLACK ANODIZED

Notice: The prices appearing in this catalog are the manufacturer's suggested retail prices. Actual retail prices may vary.

TOURING & TRIKE 407

Fairing Trim



B. DEFIANCE ELECTRA GLIDE SPEAKER GRILLS



B. DEFIANCE COLLECTION SPEAKER GRILLS

Singing a different tune. Defiance Speaker Grills wrap the Original Equipment or Boom™ Audio Stage I speakers for a harmonious look. Featuring rich honeycomb mesh and slim horizontal rails, the Defiance Speaker Grills protect the speaker cone while adding a luxurious touch to your bike's sound system. Available in your choice of mirror chrome, gloss black or cut back black finishes to match your customizing style. Sold in pairs.

Fits '14-later Electra Glide®, Street Glide® and Tri Glide® models, with Original Equipment or Stage I Speakers. Does not fit with Spectra Glo™ Speaker Illumination Kits.

76000685	Batwing Fairing – Chrome.	\$179.95
76000687	Batwing Fairing – Black Machine Cut.	\$199.95
76000686	Batwing Fairing – Black Anodized.	\$179.95

Fits '15-later Road Glide® models, with Original Equipment or Stage I Speakers. Does not fit with Spectra Glo Speaker Illumination Kits.

76000691	Road Glide Fairing – Chrome.	\$199.95
76000693	Road Glide Fairing – Black Machine Cut.	\$219.95
76000692	Road Glide Fairing – Black Anodized.	\$199.95

Fits '14-later Electra Glide, Road Glide, Street Glide and Tri-Glide models with Tour-Pak® mounted speakers, with Original Equipment or Stage I Speakers. Does not fit with Spectra Glo Speaker Illumination Kits.

76000676	Tour-Pak – Chrome.	\$199.95
76000678	Tour-Pak – Black Machine Cut.	\$219.95
76000677	Tour-Pak – Black Anodized.	\$199.95



B. DEFIANCE ROAD GLIDE SPEAKER GRILLS



B. DEFIANCE TOUR-PAK SPEAKER GRILLS

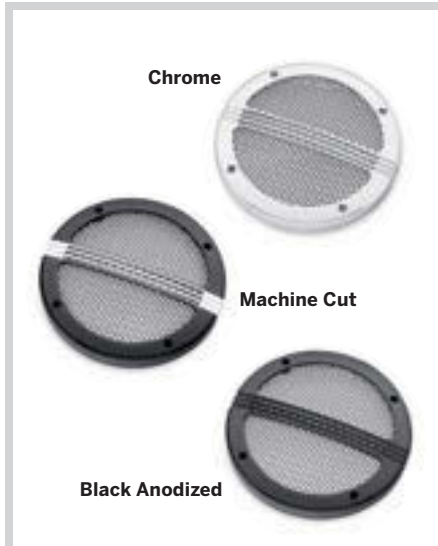

Notice: The prices appearing in this catalog are the manufacturer's suggested retail prices. Actual retail prices may vary.

408 TOURING & TRIKE

Fairing Trim

A. BURST COLLECTION GAUGE BEZEL KIT

Complete the custom look of the inner fairing. Burst Collection Gauge Bezels feature contrasting gloss black and sculpted machined surfaces that send reflections of light in all directions. The perfect match for Burst Speaker Trim, this easy to install gauge bezel kit includes Speedometer and Tachometer bezels and auxiliary gauge bezels.

61400317 4-Bezel Kit. **\$239.95**
Fits '14-later Electra Glide®, Street Glide®, Ultra Limited, Road Glide® and Tri Glide® models.

61400260 6-Bezel Kit. **\$226.95**
Fits '96-'13 Electra Glide, Street Glide, Road Glide and Trike models.



A. BURST COLLECTION GAUGE BEZEL KIT (61400317 SHOWN)

B. BURST COLLECTION SPEAKER TRIM

Sculpted machining sends reflections of light in all directions. The Burst Collection Speaker Trim features a rich black anodized finish that is machined to expose the highlights of raw aluminum. The contrasting cut-back spider makes a powerful visual statement, and works great with both traditional and contemporary customizing styles. Burst Collection Speaker Trim fits with both Original Equipment and Boom!™ Audio Speakers. Kit includes mounting hardware. Sold in pairs.

76000623 Front. **\$189.95**
Fits '14-later Electra Glide, Street Glide, Ultra Limited and Tri Glide models with Original Equipment or Boom! Audio Stage I Fairing Mount Speakers. Will not fit FLHXSE or models equipped with Boom! Audio Stage II Speakers.

76000307 Front. **\$139.95**
Fits '96-'13 Electra Glide, Street Glide (except '11-'12 FLHXSE) and Trike models with Original Equipment or Boom! Audio Fairing Mount Speakers. Does not fit Tour-Pak® or Fairing Lower Speakers.

76000621 Rear. **\$229.95**
Fits '14-later Electra Glide, Street Glide, Ultra Limited, Road Glide and Tri Glide models with Original Equipment or Boom! Audio Stage I Tour-Pak mounted speakers.

76000522 Rear. **\$221.95**
Fits '96-'13 Electra Glide, Road Glide and Tri Glide models with Original Equipment or Boom! Audio Tour-Pak mounted speakers.



A. BURST COLLECTION GAUGE BEZEL KIT (61400260 SHOWN)



A. BURST COLLECTION GAUGE BEZEL KIT (61400317 SHOWN)



A. BURST COLLECTION GAUGE BEZEL KIT (61400260 SHOWN)



B. BURST COLLECTION SPEAKER TRIM – FRONT (76000623 SHOWN)



B. BURST COLLECTION SPEAKER TRIM – REAR (76000621 SHOWN)

Notice: The prices appearing in this catalog are the manufacturer's suggested retail prices. Actual retail prices may vary.

TOURING & TRIKE 409

Fairing Trim



C. INNER FAIRING TRIM – CARBON FIBER DESIGN

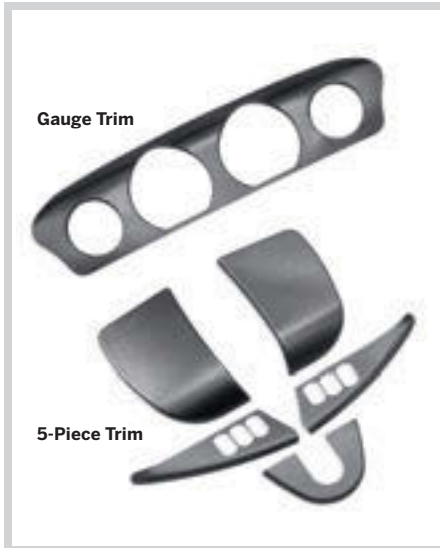

Gauge Trim

5-Piece Trim

C. INNER FAIRING TRIM – CARBON FIBER DESIGN

Transform the look of the inner fairing with this easy-to-install fairing trim accents. These self-adhesive components add a contrasting look to the expanse of satin black or color-matched surface in front of you. The 5-piece kit includes media storage door trim, left panel trim and 3-piece switch panel trim. The Gauge Trim surrounds the instrument cluster for added depth and dimension.

Fits '14-later Electra Glide®, Street Glide®, Ultra Limited and Tri Glide® models.

61400328	Gauge Trim.	\$59.95
61400334	5-Piece Trim.	\$124.95

D. GAUGE BEZEL KIT – GLOSS BLACK

Complete the custom look of the inner fairing. These aluminum Gauge Bezels feature a rich gloss black surface, and are machined to cover the bright bezel that surrounds the Original Equipment gauges. The easy to install gauge bezel kit includes Speedometer and Tachometer bezels and auxiliary gauge bezels.

61400399 4-Bezel Kit. **\$199.95**
Fits '14-later Electra Glide, Street Glide, Ultra Limited, Road Glide® and Tri Glide models.



D. GAUGE BEZEL KIT – GLOSS BLACK

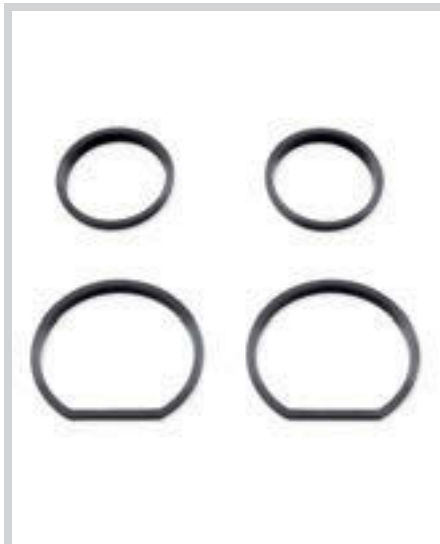

E. FORK LOCK AND IGNITION SWITCH – GLOSS BLACK

It's the details that count. When you've completed your sinister blacked-out inner fairing, console and handlebar installation, the one remaining component that still stands out is the chrome fork lock and ignition switch. These Gloss Black Ignition Switch Components replace the factory-installed chrome parts and blend into the black surroundings for a seamless look.

71400126A **\$139.95**
Fits '14-later Electra Glide, Street Glide, Ultra Limited, Road Glide and Tri Glide models (except CVO™). Keyed to match lock requires vehicle Key Code.

Shown with: ROAD GLIDE® IGNITION SWITCH PANEL TRIM – GLOSS BLACK

It's the details that count. When you've completed your sinister blacked-out Road Glide inner fairing, console and handlebar installation, the one remaining component that still stands out is the chrome switch panel. This gloss black panel replace the factory-installed chrome parts and blends into the black surroundings for a seamless look.

25700870 **\$77.14**
Fits '15-later FLTRX, FLTRXS, FLTRXSE and FLTRU models.



E. IGNITION SWITCH & SWITCH PANEL TRIM – GLOSS BLACK



71400126A

25700870

Notice: The prices appearing in this catalog are the manufacturer's suggested retail prices. Actual retail prices may vary.

410 TOURING & TRIKE

Fairing Trim

A. TAPERED FAIRING MOUNT MIRRORS

Reflect your personal style. These slim forged aluminum Fairing Mount Mirrors minimize the profile at the edges of the Batwing Fairing for a clean custom look. The single-stalk mount permits a wide range of adjustability and the convex mirror face maximizes the field of view. The mirrors are designed as a direct replacement for the Street Glide® model's Original Equipment mirrors, and can be installed on other Batwing fairing-equipped models in place of handlebar-mounted mirrors. Tapered Fairing Mirrors are available in your choice of polished chrome or gloss black Edge Cut finish to match your styling direction.

Fits '14-later Electra Glide®, Street Glide®, Ultra Limited and Tri Glide® models.

56000098A Chrome.	\$229.95
56000099A Edge Cut.	\$229.95



A. TAPERED FAIRING MOUNT MIRRORS – CHROME

B. FAIRING MOUNT MIRRORS – BLACK

Fairing Mount Mirrors offer a truly innovative look from the traditional handlebar-mounted mirrors. Mounting just inside the inner fairing, the molded plastic mirror housings complement the contours of the batwing fairing. They provide a wide range of adjustability and feature convex mirror glass that maximizes your field of view. The Bar & Shield logo is carefully laser-etched on each mirror glass. Kit includes necessary hardware, instructions and mounting template for easy installation.

56000076	\$99.95
-----------------	----------------

Fits '14-later Electra Glide, Ultra Limited and Tri Glide models. Original Equipment on Street Glide models (except FLHTCUTC).

91945-98B	\$99.95
------------------	----------------

Fits '96-'13 Electra Glide and Trike models. Original equipment on Street Glide models.



A. TAPERED FAIRING MOUNT MIRRORS – EDGE CUT

C. FAIRING MOUNT MIRRORS – CHROME

Add a splash of chrome to the batwing inner fairing. These Fairing Mount Mirrors de-clutter the handlebar and add a contemporary aero style to your ride. The attractive chrome housing provides a custom look, and the convex mirror and wide range of adjustment maximizes your field of view. A direct bolt-on replacement for Original Equipment fairing mount mirrors, the kit includes the hardware and mounting template required for easy and accurate installation on many models.

56000077	\$134.95
-----------------	-----------------

Fits '14-later Electra Glide, Street Glide, Ultra Limited and Tri Glide models. Original Equipment on Street Glide models (except FLHTCUTC).

56000029	\$134.95
-----------------	-----------------

Fits '96-'13 Electra Glide, Street Glide and Trike models. Original Equipment on '12 FLHXSE models.



B. FAIRING MOUNT MIRRORS – BLACK

C. FAIRING MOUNT MIRRORS – CHROME

D. ILLUMINATED FAIRING MOUNT MIRROR COVERS – CHROME

Add auxiliary LED turn signals and a splash of chrome to the inner fairing. The perfect finishing touch to a fully-dressed inner fairing, these chrome-plated mirror housings feature fast-acting amber LED turn signals at the outer edge. Side turn signals attract attention from the drivers around you, and the plug-in, no-splice design simplifies installation.

56000084	\$139.95
-----------------	-----------------

Fits '14-later Touring and Trike models with fairing-mount mirrors. Does not fit with Split Vision Fairing Mount Mirrors P/N 92085-10 or Tapered Fairing Mount Mirrors P/N 56000098A or 56000099A.

92600-10	\$139.95
-----------------	-----------------

Fits '06-'13 FLHX and FLHXSE, Electra Glide and '10-'11 FLHXX models equipped with Fairing Mount Mirrors P/N 91945-98B. Does not fit with Split Vision Fairing Mount Mirrors P/N 92085-10.



D. ILLUMINATED FAIRING MOUNT MIRROR COVERS – CHROME

Notice: The prices appearing in this catalog are the manufacturer's suggested retail prices. Actual retail prices may vary.



E. SWITCH PANEL ACCENT

E. SWITCH PANEL ACCENT

Dress for success. This handsome trim element frames the ignition and flanking rocker switches in chrome. Simple to install with peel-and-stick adhesive, the kit also includes inserts to cover inactive switch openings. Complete the chrome look with optional Radio Trim P/N 74612-06 and Chrome Gauge Bezels.

61400001 **\$54.95**
Fits '96-'13 Electra Glide®, Street Glide® and Trike models.

F. FORK LOCK COVER

This chrome-plated aluminum die-cast cover finishes the look of the Road King® fork lock. The protective cover adds a finishing touch to the handlebar cover and the smooth domed lid flips up to provide access to the fork lock. Includes chrome-plated flush-mount hardware.

71790-05 Fits '94-later Road King models. **\$49.95**

G. BULLSEYE CONSOLE NUT

Replace your plain stock chrome acorn nut with this special chrome-plated Console Nut that features a machined Bullseye design highlighted with black accent rings.

94755-99 **\$7.95**
Fits '93-'03 FXDWG, '90-'95 and '00-'17 Softail® (except FLSTSB, FXCW, FXCWC, FXS, FXSB, FXSBSE, FXSE, FXST-AUS, FXSTD and '09-'17 FLS, FLSS and FLSTC) and '94-'07 Road King models.

H. BULLSEYE CONSOLE WASHER

As a replacement for the plain stock washer on Road King models, this chrome-plated billet Console Washer features a three dimensional, machined-in Bullseye design, highlighted with black accent rings. A stainless steel mounting screw is provided and, once installed, is hidden under the black center insert with Bar & Shield logo.

94753-99 **\$19.95**
Fits '84-'17 Softail (except FXSB and FXSE) and '94-'07 Road King (except FLHRS) tank panels with screw mounts.

I. GAUGE VISOR RING

A touch of chrome makes all the difference. These easy-to-install trim rings feature an integrated eyebrow visor to shield the gauge face from the sun's glare. Self-adhesive backing for secure mount.

74661-04 5" Gauge. **\$27.95**
Fits '12-'17 FLD, '99-'08 FXDWG, '15-'17 FXDF, '99-'17 Softail (except FLSTFSE, FLSTNSE, FXCW, FXCWC, FXS, FXSB, FXSBSE, FXSE, FXST-Aus, FXSTD and models equipped with Chrome Console P/N 67575-04), '18-later FLFL, FLDE, FLHC and FLHCS and '99-'07 Road King models.

J. FUEL TANK MOUNTING HARDWARE KIT – CHROME

Beauty lies in the details, and this chrome-plated Fuel Tank Mounting Hardware Kit ensures you won't leave this one overlooked. The perfect finishing touch to your fuel tank, the kit includes the "Bullet Tip" custom bolts and machined washers required for the specific model application. Hardware design matches the Chrome Bullet Tip Footpeg Bolt Kit P/N 94133-01 and other available accessories.

62920-00A **\$39.95**
Fits '98-later Touring and Trike models.



F. FORK LOCK COVER – CLOSED



F. FORK LOCK COVER – OPEN



G. BULLSEYE CONSOLE NUT



H. BULLSEYE CONSOLE WASHER



I. GAUGE VISOR RING



J. FUEL TANK MOUNTING HARDWARE KIT – CHROME

Notice: The prices appearing in this catalog are the manufacturer's suggested retail prices. Actual retail prices may vary.

412 TOURING & TRIKE

Console Trim

A. GLOSS BLACK CONSOLE KIT – ROAD KING®

Lead the way to the dark side. This blacked-out Console Kit includes the major components required to change the chrome console to a dark custom look. Manufactured from Original Equipment components for superior fit and finish, the kit includes black console, console insert, gasket, and hardware.

70900821 **\$299.95**
Fits '14-later FLHR and FLHRC models.

B. GLOSS BLACK CONSOLE KIT

Lead the way to the dark side. This blacked-out Console Kit includes the major components required to change the chrome console to a dark custom look. Manufactured from Original Equipment components for superior fit and finish, the kit includes black console, gasket, and hardware. Available for models with or without 7-pin DIN headset connector. Add your choice of Fuel Door (sold separately) to set your bike apart from the crowd.

Fits '08-later Electra Glide®, Street Glide®, Ultra Limited, Road Glide® and Tri Glide® models with center fill tank.

70900463 Without CB Communications Port. **\$299.95**
70900501 With CB Communications Port. **\$299.95**



A. ROAD KING GLOSS BLACK CONSOLE KIT

C. FUEL TANK CONSOLE DOOR – THE BURST COLLECTION

Rich black surfaces and prismatic machined aluminum define the Burst Collection Fuel Door. The race-track ridges and the inner spider design make a powerful visual statement, and are the perfect match to the available Gloss Black Console and Smooth Push Button accessories. Kit includes mounting hardware.

70900474A **\$139.95**
Fits '08-later Electra Glide, Street Glide, Ultra Limited, Road Glide and Tri Glide models with center fill tank.

D. FUEL TANK CONSOLE DOOR – GLOSS BLACK

The gloss black fuel door is the perfect match for the Gloss Black Console Kit. The easy-to-install fuel door replaces the stock door, and reuses Original Equipment mounting hardware.

70900465A **\$54.95**
Fits '08-later Electra Glide, Street Glide, Ultra Limited, Road Glide and Tri Glide models with center fill tank.



B. GLOSS BLACK CONSOLE KIT
(70900463 SHOWN)
(SHOWN WITH BURST FUEL DOOR)

B. GLOSS BLACK CONSOLE KIT
(70900501 SHOWN)
(SHOWN WITH BLACK FUEL DOOR)



C. FUEL TANK CONSOLE DOOR –
THE BURST COLLECTION

D. FUEL TANK CONSOLE DOOR –
GLOSS BLACK

Notice: The prices appearing in this catalog are the manufacturer's suggested retail prices. Actual retail prices may vary.

TOURING & TRIKE 413

Console Trim

NEW



E. WILLIE G SKULL FUEL TANK CONSOLE DOOR – BLACK



F. WILLIE G SKULL FUEL TANK CONSOLE DOOR – CHROME



G. LIVE TO RIDE FUEL TANK CONSOLE DOOR – CHROME



G. LIVE TO RIDE FUEL TANK CONSOLE DOOR – GOLD



H. NUMBER ONE SKULL FUEL TANK CONSOLE DOOR



I. PUSH-BUTTON FUEL TANK CONSOLE DOOR RELEASE



J. SMOOTH PUSH-BUTTON FUEL TANK CONSOLE DOOR RELEASE – GLOSS BLACK



J. SMOOTH PUSH-BUTTON FUEL TANK CONSOLE DOOR RELEASE – CHROME

E. WILLIE G SKULL COLLECTION FUEL TANK CONSOLE DOOR – BLACK

Penned at the hand of Willie G, the famous Skull Collection makes a shift to the dark side. Completely drenched in matte black, the raised skull and surrounding Harley-Davidson Motorcycle script adds a subtle ominous touch to your ride. The matte finish easily coexists alongside gloss black or wrinkle black surfaces. These easy-to-install Fuel Doors replace the stock door, and reuse Original Equipment mounting hardware and lock.

61300794 **\$39.95**
Fits '08-later Electra Glide®, Street Glide®, Ultra Limited™, Road Glide® and Tri Glide® models with center fill tank.

F. WILLIE G SKULL FUEL TANK CONSOLE DOOR – CHROME

Add a little attitude to your ride. Styled to complement Harley-Davidson® Skull accessory items, the menacing raised skull with black-filled eyes leaps from a field of chrome. The surrounding Harley-Davidson Motorcycles script is the perfect finishing touch. These easy-to-install Fuel Doors replace the stock door, and reuse Original Equipment mounting hardware and lock.

61308-09A **\$39.95**
Fits '08-later Electra Glide, Street Glide, Ultra Limited, Road Glide and Tri Glide models with center fill tank.

61374-04 **\$39.95**
Fits '92-'07 Electra Glide, Tour Glide™ and Road Glide models with center fill tank.

G. LIVE TO RIDE FUEL TANK CONSOLE DOOR

Live To Ride, Ride to Live. It has become the motto of the Harley-Davidson nation, accompanying riders over millions of miles of travel. This collection is a tribute to that way of life. These easy-to-install Fuel Doors replace the stock door, and reuse Original Equipment mounting hardware and lock. Available in your choice of gold or chrome finish.

Fits '08-later Electra Glide, Street Glide, Ultra Limited, Road Glide and Tri Glide models with center fill tank.

61335-09A Gold. **\$39.95**

61300049A Chrome. **\$39.95**

Fits '92-'07 Electra Glide, Tour Glide and Road Glide models with center fill tank.

61286-92T Gold. **\$39.95**

H. NUMBER ONE SKULL FUEL TANK CONSOLE DOOR

The sinister Harley-Davidson #1 Skull logo dresses for a night on the town. This complete die-cast aluminum collection has been polished and chrome-plated to a brilliant shine, then finished with a contrasting black-filled Dark Custom™ Skull logo. These easy-to-install Fuel Doors replace the stock door, and reuse Original Equipment mounting hardware and lock.

62378-10A **\$39.95**
Fits '08-later Electra Glide, Street Glide, Ultra Limited, Road Glide and Tri Glide models with center fill tank.

I. PUSH-BUTTON FUEL TANK CONSOLE DOOR RELEASE

An added convenience you'll appreciate at fuel stops. This lockable replacement for your stock fuel tank console door lock allows the door to be opened without a key by depressing the center button of the lock. For basic security, it can be locked with any barrel key.

53842-00C **\$29.95**
Fits '92-later Electra Glide, Street Glide, Ultra Limited, Tour Glide, Road Glide and Tri Glide models with center fill tank.

J. SMOOTH PUSH-BUTTON FUEL TANK CONSOLE DOOR RELEASE

Add stop-and-go speed at the gas pump. The smooth button replaces the lock for push-to-open convenience. No more digging in your pocket for the key. The large button is easy to operate while wearing gloves.

Fits '92-later Electra Glide, Street Glide, Ultra Limited, Tour Glide, Road Glide and Tri Glide models with center fill tank.

53919-04A Chrome. **\$29.95**

90300096 Gloss Black. **\$29.95**

Notice: The prices appearing in this catalog are the manufacturer's suggested retail prices. Actual retail prices may vary.

TOURING

414 TOURING & TRIKE

Tour-Pak® Trim

A. TOUR-PAK® HINGE AND LATCH KIT – GLOSS BLACK

Upgrade the appearance of your Tour-Pak® luggage. These Original Equipment-style hinges and latch are polished and finished in rich gloss black. The complete kit includes hinges, latch and all necessary hardware.

53000343 \$199.95

Fits '14-later Touring and Tri Glide® models equipped with Chopped or King Tour-Pak Luggage.



A. TOUR-PAK HINGE AND LATCH KIT – GLOSS BLACK

B. PREMIUM TOUR-PAK LATCHES

Styled to complement the Premium Tour-Pak Hinges, these die-cast latches provide a bold look to your ride. Designed to eliminate the traditional catch and clamp design, these latches make access to the Tour-Pak luggage easier than ever. Simply press down on the top of the lid to secure the latching mechanism. The self-aligning design positions the lid perfectly for no-fuss closure. A simple push of the button releases the lock and pops the lid open for convenience. Latches feature hidden hardware for a clean appearance and the front latch wraps around the Original Equipment lock for a custom touch. Kit includes front and rear latch and all mounting hardware.

Fits '06-'13 Touring and Trike models equipped with King or Ultra Tour-Pak Luggage. Does not fit with Leather, Razor-Pak or Chopped Tour-Pak Luggage. Does not fit models equipped with Tour-Pak Lock Covers P/N 53000217 or 53000218.

53000252 Chrome. \$109.95

53000253 Gloss Black. \$109.95

C. PREMIUM TOUR-PAK HINGES

Upgrade the appearance of your Tour-Pak luggage with billet-style premium hinges. Styled to complement the Original Equipment Tour-Pak latches, these hinges add a clean, bold look with no exposed hardware. Available in mirror chrome or gloss black finish, the complete kit includes two hinges and all necessary hardware. Drill is required to remove the factory installed hinge mounting rivets.

Fits '88-'13 Touring and Trike models equipped with Razor-Pak, Chopped or King Tour Pak luggage.

79211-08A Chrome. \$52.95

53000131 Gloss Black. \$52.95



B. PREMIUM TOUR-PAK LATCHES – CHROME



B. PREMIUM TOUR-PAK LATCHES – GLOSS BLACK



C. PREMIUM TOUR-PAK HINGES – CHROME



C. PREMIUM TOUR-PAK HINGES – GLOSS BLACK

Notice: The prices appearing in this catalog are the manufacturer's suggested retail prices. Actual retail prices may vary.

TOURING & TRIKE 415

Tour-Pak® Trim



D. TOUR-PAK LATCHES – GLOSS BLACK

D. TOUR-PAK® LATCHES – GLOSS BLACK

Add a custom touch to your Tour-Pak® luggage. Styled to complement available gloss black Premium Tour-Pak Hinges, these Original Equipment-style latches are polished and finished in rich gloss black. The complete kit includes latches, hasps and all necessary hardware.

53000130 **\$39.95**
Fits '88-'13 Touring and Trike models equipped with Razor-Pak, Chopped or King Tour-Pak Luggage.

E. EZ TOUR-PAK LID CATCH

Add the convenience of a self-aligning Tour-Pak lid to your Touring bike. Simply close the lid and latch it down. This easy-to-install kit eliminates the need to shift the position of the lid because the latches line up perfectly every time.

53000195 **\$14.95**
Fits '85-'13 Touring and Trike models equipped with King, Ultra or Razor-Pak Tour-Pak Luggage. Does not fit Chopped, Leather or Sport Tour-Pak Luggage.



E. EZ TOUR-PAK LID CATCH



F. TOUR-PAK LOCK COVER

This elegant die-cast cover with a Bar & Shield logo adds a custom touch to your Tour-Pak lock. Simply use your thumb to rotate the domed cover to expose the Original Equipment lock. A detent holds the cover in the open position and provides unhindered access for your key. Easy to install, the protective cover is held firmly in place by the Original Equipment lock and lock mounting hardware.

Fits '88-'13 Touring and Trike models equipped with King, Razor-Pak or Chopped Tour-Pak Luggage. Does not fit with Premium Tour-Pak Latches P/N 53000252 or 53000253.

53000217 Chrome. **\$32.95**
53000218 Gloss Black. **\$32.95**

G. RETRACTABLE TOUR-PAK LID TETHER

Add the convenience of a Retractable Tether to your Tour-Pak luggage. When extended to its full length, the strong cord holds the lid open at least 10° past vertical for improved stability and easy packing. Then the device automatically coils the tether cord inside the housing to eliminate pinched cords when closing the lid. The attractive housing with Bar & Shield logo attaches to the existing mounting points and replaces the Original Equipment cord.

54171-11 **\$31.95**
Fits '97-'13 Touring and Trike models equipped with a King, Ultra, Chopped or Razor-Pak Tour-Pak Luggage. Will not fit Leather or Sport Tour-Pak Luggage.

H. RETRACTABLE TRUNK DOOR TETHER

Add the convenience of a Retractable Tether to your Trike trunk door. The tethers easily mount to your trunk door and replace the stock support cords. When you open the trunk door, the tether smoothly deploys from the housing to support the door in the full open position. Then as you close the door, the device automatically coils the tether cord inside the housing to eliminate pinched cords. The attractive housing with Bar & Shield logo attaches to the existing mounting points. Sold in pairs.

53000237 **\$59.95**
Fits '11-later Tri Glide® models.



F. TOUR-PAK LOCK COVER – CHROME



F. TOUR-PAK LOCK COVER – GLOSS BLACK



G. RETRACTABLE TOUR-PAK LID TETHER



H. RETRACTABLE TRUNK DOOR TETHER

Notice: The prices appearing in this catalog are the manufacturer's suggested retail prices. Actual retail prices may vary.

TOURING

416 TOURING & TRIKE

Saddlebag Trim

A. SADDLEBAG LATCH AND HINGE KIT – GLOSS BLACK

Gloss Black Saddlebag Hinge Covers and finger-operated Latches are an easy way to give your Touring bike a unique monochrome look. These latches add a dark custom touch to the motorcycles's profile, and complement almost any paint combination. Easy to install with Original Equipment hardware and reflectors.

90200914 Latch Lever and Hinge Cover Kit. **\$194.95**
Fits '14-later Touring models (except FLHXSE and FLTRXSE) equipped with hard saddlebags.

90201052 Latch Lever only. **\$74.95**
Fits '14-later Touring models (except FLHXSE and FLTRXSE) equipped with hard saddlebags.



A. SADDLEBAG LATCH AND HINGE KIT – GLOSS BLACK



A. SADDLEBAG LATCH AND HINGE KIT – GLOSS BLACK

B. SADDLEBAG LATCH PLATE – VIVID BLACK

Saddlebag Latch Plates are an easy way to give your Touring bike a unique monochrome look. Available in Vivid Black, these latches add a splash of color to the motorcycle profile. Easy to install with Original Equipment hardware.

Fits '93-'13 Touring models equipped with Color-Matched Hard Saddlebags. HDI models require separate purchase of Reflectors P/N 59289-92 and 59290-92.

90853-06DH Right Side. **\$59.95**

90857-06DH Left Side. **\$59.95**



A. SADDLEBAG LATCH AND HINGE KIT – GLOSS BLACK



B. SADDLEBAG LATCH PLATE – VIVID BLACK

C. BILLET SADDLEBAG HINGE COVER KIT – EDGE CUT

Dress your saddlebags in style. Edge Cut Saddlebag Hinge Covers feature a rich black finish that is machined to expose the highlights of raw aluminum. The contrasting cut-back look makes a powerful visual statement, and works great with both traditional and contemporary customizing styles. These covers replace the Original Equipment covers, but retain the stock hinges and locks for easy installation. Kit includes left and right covers, mounting hardware and saddlebag-mounted red reflectors.

90200915 **\$159.95**
Fits '14-later Touring (except FLHRC) models equipped with hard saddlebags. HDI models require separate purchase of amber Reflector P/N 59289-92 and 59290-92.

90200421 **\$139.95**
Fits '93-'13 Touring models equipped with hard saddlebags. HDI models require separate purchase of Reflector P/N 59289-92 and 59290-92.



C. BILLET SADDLEBAG HINGE COVER KIT – EDGE CUT (90200915 SHOWN)



C. BILLET SADDLEBAG HINGE COVER KIT – EDGE CUT (90200421 SHOWN)

D. BILLET SADDLEBAG HINGE COVER KIT – CHROME GROOVED

This sweep of chrome will set the tone for a very special Touring custom. Manufactured from billet aluminum, this polished and plated cover replaces the Original Equipment saddlebag hinge for a striking look. The grooved ball-milled design and curved leading and trailing edge add a feeling of forward motion, even while parked on Main Street. Kit includes chrome-plated mounting hardware and red saddlebag-mounted reflectors.

90201084 **\$159.95**
Fits '14-later Touring (except FLHRC) models equipped with hard saddlebags. HDI models require separate purchase of amber Reflector P/N 59289-92 and 59290-92.

90645-03A **\$139.95**
Fits '93-'13 Touring models equipped with hard saddlebags. HDI models require separate purchase of Reflector P/N 59289-92 and 59290-92.



D. BILLET SADDLEBAG HINGE COVER KIT – CHROME GROOVED (90201084 SHOWN)



D. BILLET SADDLEBAG HINGE COVER KIT – CHROME GROOVED (90645-03A SHOWN)

Notice: The prices appearing in this catalog are the manufacturer's suggested retail prices. Actual retail prices may vary.

TOURING & TRIKE 417

Chassis Trim – Rear End



E. FENDER SUPPORT KIT – GLOSS BLACK

E. FENDER SUPPORT KIT – GLOSS BLACK

Manufactured from Original Equipment components to ensure superior fit and finish, the gloss black Fender Support Kit replaces the Original Equipment cast and chrome fender support system and continues the dark look to the area between and behind the saddlebags. The ideal finishing touch for your blacked-out Touring bike, these covers are the perfect complement to the optional gloss black Passenger Sissy Bars, Luggage Racks, Tour-Pak® mounting racks and Docking Hardware Kits. Kit includes gloss black left and right supports and docking hardware slot fillers.

90201206

Fits '14-later Touring models.

\$299.95

F. FENDER STRUT COVERS – GLOSS BLACK

Manufactured from Original Equipment components to ensure superior fit and finish, the gloss black Fender Strut Covers conceal the cast fender struts and continue the dark look to the area behind the saddlebags. The ideal finishing touch for your blacked-out Touring bike, these covers are the perfect complement to the optional gloss black Passenger Sissy Bars, Stealth Luggage Rack and Docking Hardware Kits.

47498-09

Fits '09-'13 Touring models (except models equipped with rigid-mounted Tour-Pak luggage.)

\$109.95

G. CHROME SADDLEBAG FILLER STRIP KIT

45896-98 Slotted.

\$109.95

Fits '95-'08 Electra Glide® (except FLHX), '94-'08 Road King® (except FLHRS and FLHRSE) and '93 FLHS models equipped with Nostalgic Saddlebag Guard Rails P/N 90839-94. Also fits '98 FLHRCI with Nostalgic Saddlebag Guard Rails P/N 91265-98. (Will not fit models equipped with Leather Saddlebags P/N 90652-94A, 90843-93 or Fender Rail P/N 91019-92A. Will not fit '98-'08 FLHRCI with H-D® Detachables™ Docking Kit or '98-'08 FLTR.)

H. LOWER BELT GUARD COVER – CHROME

Dress your lower belt guard in chrome. This polished and chrome-plated metal guard is formed to fit over the Original Equipment belt guard for easy installation.

60408-09

Fits '07-later Touring models.

\$79.95



E. FENDER SUPPORT KIT – GLOSS BLACK



F. FENDER STRUT COVERS – GLOSS BLACK



G. CHROME SADDLEBAG FILLER STRIP KIT – SLOTTED '95-'08 MODELS



H. LOWER BELT GUARD COVER – CHROME

Notice: The prices appearing in this catalog are the manufacturer's suggested retail prices. Actual retail prices may vary.

418 TOURING & TRIKE

Chassis Trim – Trike

A. FENDER TRIM KIT – CHROME

This Chrome Fender Trim Kit dresses the opening of the wheel well and adds a touch of elegance to the rear of the bike. With no visible fasteners, the trim accentuates the shape and protects the painted edge of the rear fender from minor stone chips. Self-adhesive backing for easy installation.

83812-09 **\$104.95**
Fits '09-later FLHTCUTG and '10-'11 FLHXXX models.



A. FENDER TRIM KIT – CHROME



B. WHEEL CENTER COVER KIT

B. WHEEL CENTER COVER KIT

These chrome-plated hubcaps add style and depth to the Trike's rear wheels. The snap-fit covers have no visible fasteners for a clean, custom look.

83841-09 **\$41.95**
Fits '09-later FLHTCUTG, '10-'11 FLHXXX and '15-later FLRT models. Installation on Original Equipment wheel requires removal of wheel and factory center medallion.

C. EXHAUST TRIM

This chrome-plated accent piece trims the exhaust openings in the trunk fascia and adds a touch of brightwork to the rear of the bike. Easy to install with no visible fasteners, the formed steel trim features pre-applied high-temp adhesive backing for a clean, uncluttered look.

83843-09 **\$41.95**
Fits '09-later FLHTCUTG and '10-'11 FLHXXX models.



C. EXHAUST TRIM



D. TRIKE MUD FLAPS – TRI GLIDE LOGO

D. TRIKE MUD FLAPS – TRI GLIDE LOGO

Custom-fit Mud Flaps protect the sides of your Trike's trunk box from spray and road debris and keep the finish clean and free of mud and tar buildup. Custom molded for a perfect fit, these matte black mud flaps feature a raised light gray Tri Glide script logo. Kit includes left and right mud flap, reinforcing brackets and mounting hardware.

59600018 **\$59.95**
Fits '09-later FLHTCUTG and '10-'11 FLHXXX models.

E. TRUNK GUARD

Unique rear guard wraps around the bodywork to protect your finish from damage. Lightweight steel tubing incorporates high-quality welded joints and is hand-polished and chrome-plated for a brilliant finish. Kit includes all necessary mounting hardware for bolt-on installation.

83825-09B **\$249.95**
Fits '09-later FLHTCUTG and '10-'11 FLHXXX models.

49000069 **\$249.95**
Fits '15-later FLRT models.



E. TRUNK GUARD – TRI GLIDE



E. TRUNK GUARD – FREEWHEELER

F. ILLUMINATED FASCIA ACCENT TRIM*

Sweeping chrome trim dresses the trunk fascia for a distinctive yet functional look. The inset LED light bar glows as a running lamp when the ignition is on and functions as an auxiliary red lamp when the brakes are applied. Available with smoked or red LED lens to match your customizing direction. Can be installed on models equipped with Trunk Guard.

Fits '14-later Tri Glide® models. Will not fit with Exhaust Trim P/N 83843-09.

68000128 Smoked Lens. **\$249.95**

68000129 Red Lens. **\$249.95**

Fits '09-'13 Trike models. Will not fit with Exhaust Trim P/N 83843-09.

84023-11 Red Lens. **\$249.95**



F. ILLUMINATED FASCIA ACCENT TRIM – RED LENS



***WARNING:** Disconnecting your DOT required tail, brake and turn signal lighting could reduce your visibility to others and result in death or serious injury.

Notice: The prices appearing in this catalog are the manufacturer's suggested retail prices. Actual retail prices may vary.

TOURING & TRIKE 419

Tour-Pak® Lighting

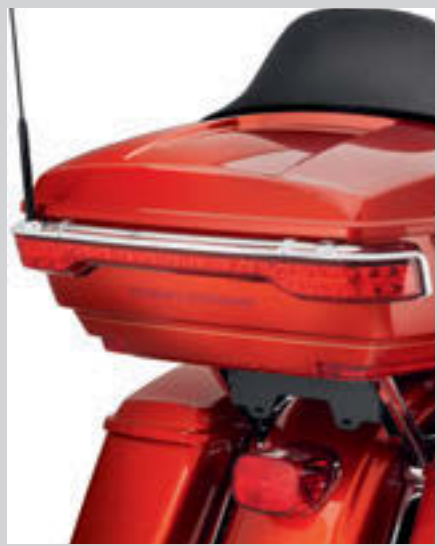

G. TOUR-PAK REAR LIGHT TRIM



H. TOUR-PAK SIDE MARKER LIGHT TRIM

G. TOUR-PAK® REAR LIGHT TRIM

Add a custom touch to the Original Equipment Tour-Pak carrier's rear lighting. This mirror chrome trim covers the satin black surface and adds a brilliant finishing touch to the rear of the bike. Self-adhesive mounting simplifies installation.

53000329 \$79.95
Fits '14-later FLHTCU, FLHTCUL, FLHTK, FLHTKL, FLTRU, FLHTCUTG and models equipped with accessory King Tour-Pak and LED wrap-around tail lamp. Does not fit with Accent Rail P/N 53000229.

H. TOUR-PAK SIDE MARKER LIGHT TRIM

Add a custom touch to the Original Equipment Tour-Pak carrier's side lighting. Mirror chrome trim surrounds the side marker lights for a bit of flash and the self-adhesive backing simplifies installation. Kit includes left and right side trim.

53000330 \$79.95
Fits '14-later FLHTCU, FLHTCUL, FLHTK, FLHTKL, FLTRU and FLHTCUTG models with Original Equipment King Tour-Pak-mounted side lights. Also fits '14-later models equipped with accessory King Tour-Pak and Side Marker Light Kits P/N 54352-09 or 69494-06.

I. TOUR-PAK SIDE MARKER LIGHT KIT

This wrap-around Side Marker Light Kit adds a splash of light to the lower edge of the Tour-Pak Luggage System. It replaces the chrome side trim along the lower edge of the Tour-Pak luggage on Electra Glide® Classic models or replaces the Original Equipment red lens featured on Ultra Classic® Electra Glide and Tri Glide® models. Available in your choice of red or smoked lens. The smoked lens remains stealthy while the ignition is off, but glows red when the lights are switched on. Complete kit includes left and right lens housings, wiring harness and all required installation hardware.

Fits '06-later Touring and Trike models equipped with King Tour-Pak luggage.

54352-09	Smoked Lens.	\$119.95
69494-06	Red Lens.	\$119.95



I. TOUR-PAK SIDE MARKER LIGHT KIT – SMOKED (ON)



J. LED KING TOUR-PAK BRAKE/TURN/TAIL LAMP KIT – SMOKED LENS

J. LED KING TOUR-PAK BRAKE/TURN/TAIL LAMP KIT – SMOKED LENS*

Add a sinister touch to the rear of your bike. This smoked LED lamp kit is a direct plug-in replacement for the stock LED red lens wrap-around Tour-Pak carrier's light. The bright fast-acting LEDs glow bright red when activated, but nearly disappear behind the dark smoke lens when off. The lamp features a flat black surround that complements any solid or two-tone paint color and accommodates single and dual-antenna applications. No cutting or splicing is required for installation.

67800368 \$299.95
Fits '14-later FLHTCU, FLHTCUL, FLHTK, FLHTKL, FLTRU and FLHTCUTG models.

K. LED KING TOUR-PAK BRAKE/TURN/TAIL LAMP KIT*

Add high-mount turn signals, running and brake lamps to your Classic and Ultra King Tour-Pak luggage. This wrap-around light kit is equipped with bright, fast-acting LED lamps that grab the attention of following traffic. The corner lights operate in run/brake/turn mode and the center lamp functions as a run and brake lamp. The slim-line design mounts to the exterior surface of the Tour-Pak luggage and can be used to replace the Original Equipment Ultra-style lamp. When equipped with Tour-Pak Liner P/N 53302-07 (sold separately), this kit eliminates the interior bulges and maximizes the carrying capacity inside. Available with smoked or red lens, the lamp features a flat black surround that complements any solid or two-tone paint color. Kit accommodates single and dual-antenna applications. No cutting or splicing is required for installation and kit includes a simple drilling template, interior mounting plates, mounting hardware and wiring harness.

Fits '97-'13 Touring models (except CVO™) equipped with King Tour-Pak luggage.

67932-11	Red Lens.	\$499.95
67931-11	Smoked Lens.	\$499.95



K. LED KING TOUR-PAK BRAKE/TURN/TAIL LAMP KIT – RED LENS



K. LED KING TOUR-PAK BRAKE/TURN/TAIL LAMP KIT – SMOKED LENS



***WARNING:** Disconnecting your DOT required tail, brake and turn signal lighting could reduce your visibility to others and result in death or serious injury.

Notice: The prices appearing in this catalog are the manufacturer's suggested retail prices. Actual retail prices may vary.

TOURING

420 TOURING & TRIKE

Tour-Pak® & Saddlebag Lighting

A. LED LIGHT KIT – TOUR-PAK® SPOILERS

Custom fit to Tour-Pak® Spoilers, these fast-acting LED Light Kits operate as a supplemental rear running light and brake light. The high mounting position places the light in the line-of-sight of following vehicles, and the bright, fast-acting red LED lamps get you noticed. Wiring is concealed for a clean, custom installation. Available with red or smoked lens.

Fits '14-later Touring models equipped with Tour-Pak Spoiler Kit. FLHX, FLHXS, FLTRX and FLTRXS models will require separate purchase of Wiring Harness P/N 69201157.

53000238 Red Lens. **\$99.95**

53000239 Smoked Lens. **\$99.95**

LED REPLACEMENT LIGHT KITS

Fits Color-Matched Tour-Pak Spoiler or Saddlebag Spoiler on '94-'13 models.

68160-99 Tour-Pak Spoiler. **\$69.95**

68192-99 Saddlebag Spoiler. **\$49.95**

B. LED LIGHT KIT – SADDLEBAG SPOILERS

Custom fit to Saddlebag Lid Spoilers, these fast-acting LED Light Kits operate as a supplemental rear running light, brake light and turn signals. The bright, fast-acting red LED lamps get you noticed and the mounting position places the light above the traditional rear fender-mounted lamps and closer to the line-of-sight of following vehicles. Wiring is concealed for a clean, custom installation. Available with red or smoked lens.

Fits '14-later Touring models equipped with Saddlebag Spoiler Kit (sold in pairs).

90200735 Red Lens. **\$99.95**

90200736 Smoked Lens. **\$99.95**

See page 801 for a complete list of available Color-Matched options.

C. ELECTRA GLO™ KEYSTONE AUXILIARY LED RUN/ BRAKE/TURN LAMPS*

Nestled in the fender strut opening, these Keystone LED lamps add stylish and practical lighting to the rear of the bike. The red LED lights emit a soft neon-like glow when the ignition is on and the center row of fast-acting LED lamps burn brightly when the brakes or turn signals are activated. And when the bike is parked, the dark lamps fill the gap between the fender and saddlebags for a clean, uncluttered look. The easy-to-install lamps are mounted in a sealed housing that slips into the opening, and are held in place with the saddlebag support hardware and an adhesive pad. Complete kit includes left and right lamps and a plug-and-play wiring harness.

67800589 **\$299.95**

Fits '14-later FLHTCU, FLHTCUL, FLHTK, FLHTKL and FLTRU models.

D. ELECTRA GLO SADDLEBAG SIDE MARKER LIGHT KIT

This wrap-around Side Marker Light Kit adds a splash of light to the lower edge of the color-matched saddlebags. Available in your choice of red or smoked lens, the bright band of LED lamps is housed in a mirror chrome frame that hugs the bottom of the saddlebag. The low-profile self-adhesive Electra Glo™ lamps can be installed on models equipped with standard-length saddlebags, and are compatible with optional saddlebag guard rails. Easy to install kit includes left and right lamp and quick-disconnect wiring harness.

Fits '14-later Touring models with hard saddlebags. Not compatible with CVO™ or other models equipped with Stretched Saddlebags. '14-later models require separate purchase of Electrical Harness Extension P/N 69200722. '17-later models require Electrical Harness Extension P/N 69201599A.

68000082 Red Lens. **\$249.95**

68000083 Smoked Lens. **\$249.95**



A. LED LIGHT KIT – TOUR-PAK SPOILERS '14-LATER MODELS



B. LED LIGHT KIT – SADDLEBAG SPOILERS '14-LATER MODELS

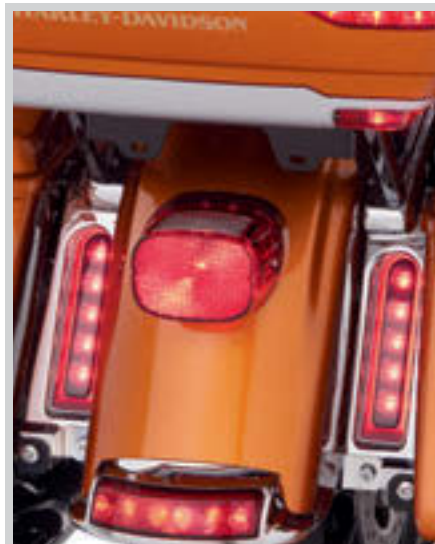

C. ELECTRA GLO KEYSTONE AUXILIARY LED RUN/BRAKE/TURN LAMP – BRAKES APPLIED



C. ELECTRA GLO KEYSTONE AUXILIARY LED RUN/BRAKE/TURN LAMP



D. ELECTRA GLO SADDLEBAG SIDE MARKER LIGHT KIT – RED LENS



D. ELECTRA GLO SADDLEBAG SIDE MARKER LIGHT KIT – SMOKED LENS



***WARNING:** Disconnecting your DOT required tail, brake and turn signal lighting could reduce your visibility to others and result in death or serious injury.

Notice: The prices appearing in this catalog are the manufacturer's suggested retail prices. Actual retail prices may vary.

TOURING & TRIKE 421

Saddlebag Lighting



E. ELECTRA GLO LED SADDLEBAG RUN/BRAKE/TURN LAMP

E. ELECTRA GLO™ LED SADDLEBAG RUN/BRAKE/TURN LAMP*

Add functional lighting to the rear of your Touring bike. These running, directional and brake lights command the attention of following vehicles. The bright, fast-acting LED lamps glow red when the ignition is on, and intensify when the turn signals or brakes are activated. The lamps act as a supplement to the Tour-Pak® luggage mounted rear lighting. The lamps are housed in a low-profile frame that is contoured to hug the curve of the hard saddlebags. The self-adhesive lamps fit seamlessly beneath the saddlebag lid and add a stylish touch of color, even when the bike is parked. Complete kit includes left and right lamps, modulator and quick-disconnect wiring harness.

Fits '14-later FLHTCU, FLHTCUL, FLHTK, FLHTKL, FLTRU and '16-later FLHTKSE or FLTRUSE models.

67800241A	Chrome Housing/Red Lens.	\$239.95
67800242A	Chrome Housing/Smoked Lens.	\$239.95
67800607	Black Housing/Red Lens.	\$239.95
67800604	Black Housing/Smoked Lens.	\$239.95

Fits '14-later FLHRXS, FLHX, FLHXS, FLTRX and FLTRXS models. Does not fit Canadian models.

67800448A	Chrome Housing/Red Lens.	\$239.95
67800450A	Chrome Housing/Smoked Lens.	\$239.95
67800608	Black Housing/Red Lens.	\$239.95
67800605	Black Housing/Smoked Lens.	\$239.95

Fits '14-later FLHR models, '14-'15 FLHTKSE, '14 FLHRSE, and '15 FLTRUSE models. Also fits Canadian FLHRXS, FLHX, FLHXS, FLTRX and FLTRXS models.

67800449A	Chrome Housing/Red Lens.	\$239.95
67800451A	Chrome Housing/Smoked Lens.	\$239.95
67800609	Black Housing/Red Lens.	\$239.95
67800606	Black Housing/Smoked Lens.	\$239.95



E. ELECTRA GLO LED SADDLEBAG RUN/BRAKE/TURN LAMP – CHROME HOUSING/SMOKED LENS



E. ELECTRA GLO LED SADDLEBAG RUN/BRAKE/TURN LAMP – BLACK HOUSING/RED LENS



E. ELECTRA GLO LED SADDLEBAG RUN/BRAKE/TURN LAMP – BLACK HOUSING/SMOKED LENS



***WARNING:** Disconnecting your DOT required tail, brake and turn signal lighting could reduce your visibility to others and result in death or serious injury.

Notice: The prices appearing in this catalog are the manufacturer's suggested retail prices. Actual retail prices may vary.

422 TOURING & TRIKE

Rear Lighting

A. LIGHT BAR WITH LED BULLET TURN SIGNALS*

These Turn Signals feature fast-acting, extra bright LEDs set in compact bullet-shaped die-cast housings. Available with red or smoked lenses, these lamps glow a bright red color when functioning as brake lamps, running lights and directional indicators. The kit includes the Rear Light Bar with integrated down-lighting for the license plate, bullet lamp housings and wiring. Installation does not require installation of a control box or load equalizer and the turn signals attach directly to existing wiring without cutting or splicing. These LED signals are the perfect match for the available LED Front Turn Signals. Meets DOT requirements.

Fits '17-later FLHRXS and '14-later FLHX, FLHXS, FLTRX, and FLTRXS models with Original Equipment rear bullet stop/turn/tail light bar.

67800493	Black – Red Lens.	\$299.95
67800494	Black – Smoked Lens.	\$299.95
67800491	Chrome – Red Lens.	\$299.95
67800492	Chrome – Smoked Lens.	\$299.95

B. BULLET REAR LIGHT BAR – GLOSS BLACK*

Complete the blacked-out treatment of your custom Touring bike. This complete kit replaces the Original Equipment chrome bar and lamps with a sinister black edition for a minimalistic look. The kit includes the Rear Light Bar with integrated down-lighting for the license plate, bullet lamp housings with integrated down-lighting for the license plate, bullet lamp housings and wiring.

Fits '10-later Street Glide® and Road Glide® models with Original Equipment rear bullet turn signal light bar.

67800483	Domestic.	\$199.95
67800484	International.	\$399.95



A. LIGHT BAR WITH LED BULLET TURN SIGNALS – BLACK WITH SMOKED LENSES



A. LIGHT BAR WITH LED BULLET TURN SIGNALS – CHROME WITH RED LENSES



A. LIGHT BAR WITH LED BULLET TURN SIGNALS



B. BULLET REAR LIGHT BAR – GLOSS BLACK



***WARNING:** Disconnecting your DOT required tail, brake and turn signal lighting could reduce your visibility to others and result in death or serious injury.

Notice: The prices appearing in this catalog are the manufacturer's suggested retail prices. Actual retail prices may vary.

TOURING & TRIKE 423

Rear Lighting



C. ELECTRA GLO STEALTH AUXILIARY LED RUN/ BRAKE/TURN LAMP – ON



C. ELECTRA GLO STEALTH AUXILIARY LED RUN/BRAKE/TURN LAMP

C. ELECTRA GLO™ STEALTH AUXILIARY LED RUN/ BRAKE/TURN LAMPS*

Keep a low profile while drawing maximum attention. These covert lamps hug the bottom edge of the saddlebags, and provide a subtle band of red light beneath the bike when the ignition is on. To help grab the attention of following drivers, the fast-acting LED lamps increase in intensity when the brakes or turn signals are applied. Strong adhesive pads secure the water- and shock-proof housings to the bags, and the quick-release wiring harness connects to the bike's wiring without splicing. Kit includes left and right lamp and quick-disconnect wiring harness.

Fits '14-later Touring models with standard hard saddlebags. Does not fit models equipped with Original Equipment or accessory Stretched Saddlebags or with some 4.5" accessory mufflers.

67800554	Red Lens.	\$149.95
67800555	Smoked Lens.	\$149.95

Fits '93-'13 Touring models with standard hard saddlebags. Does not fit models equipped with Original Equipment or accessory Stretched Saddlebags.

67800574	Red Lens.	\$149.95
67800575	Smoked Lens.	\$149.95



D. CENTER-MOUNT AUXILIARY RUNNING & BRAKE LIGHT



D. CENTER-MOUNT AUXILIARY RUNNING AND BRAKE LIGHT*

Brilliant red center-mount running and brake light grabs the attention of following vehicles. The fast-acting long life LEDs glow red when ignition is on and intensify when the brakes are applied. The low-profile chrome shell attaches to and hugs the contour of the turn signal bar for a custom look. Plug-in connection for easy installation.

68000119A		\$129.95
Fits '14-later FLHX, FLHXS, FLTRX and FLTRXS models.		

68000029A		\$129.95
Fits '10-'13 FLHX and FLTRX models.		

E. TRI-BAR LIGHT UPGRADE – AUXILIARY RUNNING LIGHT/BRAKE LIGHT*

Upgrade the Original Equipment Tri-Bar fender light from a single-mode running light to a dual-mode running and brake light. The three smoked light bands glow red in the running mode and increase in intensity when the brakes are applied.

68358-07A		\$99.95
Fits '06-'09 FLHX models.		

67774-10		\$149.95
Fits '10-later FLHX and FLTRX models (except HDI models).		



E. TRI-BAR LIGHT UPGRADE – AUXILIARY RUNNING LIGHT/BRAKE LIGHT



F. REAR FENDER TIP LIGHT – AUXILIARY RUNNING LIGHT/BRAKE LIGHT*

Upgrade your Touring model's Original Equipment fender tip light from a single-mode running light to a dual-mode running and brake light. The brilliant lamp glows red in the running mode and increases in intensity when the brakes are applied. The available smoked or red lenses complement any styling direction. Easy plug-in connection to the Original Equipment wiring harness.

Fits '09-'16 FLHTC, FLHTCU, FLHTCUL, FLHTK, FLHTKL and '16 FLTRU models.

59685-10	Red Lens.	\$99.95
59776-10	Smoked Lens.	\$99.95



F. REAR FENDER TIP LIGHT – AUXILIARY RUNNING LIGHT/BRAKE LIGHT



! WARNING: Disconnecting your DOT required tail, brake and turn signal lighting could reduce your visibility to others and result in death or serious injury.

Notice: The prices appearing in this catalog are the manufacturer's suggested retail prices. Actual retail prices may vary.

TOURING

424 TOURING & TRIKE

Rear Lighting

A. CURVED LICENSE PLATE FRAME WITH LED LIGHTING*

Dress up the rear of your Street Glide® or Road Glide® model and add practical auxiliary lighting at the same time. Designed to replace the Original Equipment black license plate bracket, this curved license plate frame is shaped to hug the contours of the rear fender. The mount attaches to the underside of the rear turn signal bar, and the smooth license plate frame with signature Harley-Davidson script appears to float above the fender for a custom look. The frame features two vertical LED halo lights that glow while in the run mode and burn brightly when the brakes are applied. Kit includes all necessary harnesses and connectors to enable complete installation – no drilling or wire splicing is required. Available in your choice of chrome or gloss black finish.

Fits '10-later FLHRXS, FLHX, FLHXS, FLTRX and FLTRXS models.

67900275	Chrome.	\$159.95
67900273	Gloss Black.	\$159.95



A. CURVED LICENSE PLATE FRAME WITH LED LIGHTING – CHROME



A. CURVED LICENSE PLATE FRAME WITH LED LIGHTING – GLOSS BLACK

B. CURVED LICENSE PLATE FRAME – TOURING

Love the look of your bike but hate the appearance of your state-mandated license plate? This stylish Curved License Plate Frame is shaped to hug the contour of the rear fender. Designed to replace the Original Equipment black license plate bracket, installation requires no drilling or rewiring. The front frame cover conceals the plate's mounting holes and raw edges and the curved shape hides the unfinished rear side of the plate. Available in chrome or gloss black finish, the complete kit includes all required mounting hardware.

Fits '10-later FLHRXS, FLHX, FLHXS, FLTRX and FLTRXS models.

67900008	Chrome.	\$94.95
67900058	Gloss Black.	\$94.95

Fits '09, FLHR, FLHT and FLTR and '06-'08 FLHX models.

67900056	Chrome.	\$94.95
-----------------	---------	----------------



B. CURVED LICENSE PLATE FRAME – TOURING, CHROME



B. CURVED LICENSE PLATE FRAME – TOURING, GLOSS BLACK

C. TOUR-PAK® LUGGAGE AND SADDLEBAG INTERIOR LIGHT KIT

Don't be left in the dark. This bright convenience lamp kit turns nighttime into day when you open your Tour-Pak® luggage or saddlebag. A brilliant white LED light pod mounts inside the Tour-Pak luggage to illuminate the interior and the two available LED light pods mount to the bottom of the Tour-Pak luggage to cast light inside the open saddlebags. Each LED light pod features a soft-touch micro switch for ease of activation and a 5-minute auto shutoff timer to prevent battery drain.

3-Light Tour-Pak & Saddlebag Light Kit

68000151 **\$119.95**
Fits '14-later Touring models equipped with rigid or detachable King Tour-Pak Luggage.

1-Light Tour-Pak Light Kit

68000152 **\$94.95**
Fits '14-later Touring models equipped with rigid or detachable King Tour-Pak Luggage.



C. TOUR-PAK LUGGAGE AND SADDLEBAG INTERIOR LIGHT KIT – '14-LATER MODELS



D. TRUNK INTERIOR LIGHT KIT

Don't be left in the dark. This bright convenience lamp kit turns nighttime into day when you open your Trike's trunk. Two brilliant white LED light pods mount inside the trunk to illuminate the interior and the included contact switch turns the light on and off when you open and close the door. A 5-minute auto shut-off timer prevents battery drain. Kit includes wiring harness and installation hardware.

83946-11 Fits '09-later FLHTCUTG models. **\$84.95**



D. TOUR-PAK LUGGAGE AND SADDLEBAG INTERIOR LIGHT KIT (68000151 SHOWN)



D. TRUNK INTERIOR LIGHT KIT



***WARNING:** Disconnecting your DOT required tail, brake and turn signal lighting could reduce your visibility to others and result in death or serious injury.

Notice: The prices appearing in this catalog are the manufacturer's suggested retail prices. Actual retail prices may vary.

TOURING & TRIKE 425

Electrical Accessories



E. AUXILIARY POWER PORT – TOUR-PAK MOUNT



AUXILIARY POWER PORTS

Power your cell phone, GPS, portable music player or tire inflator from this handy 12-volt power port. The conventional style power outlet accepts most 12V automotive power adapter plugs, and features a pop-top cover to protect the port while not in use.

E. AUXILIARY POWER PORT – TOUR-PAK® MOUNT

Easy access power port mounts to the wall of the Tour-Pak® luggage, allowing you to recharge music players and cell phones in a secure locked location.

69200826 **\$40.95**

Fits '14-later FLHTCU, FLHTCUL and FLHTCUTG models.

Original Equipment on FLHTK and FLHTKL.

91671-10 **\$49.95**

Fits '06-'13 FLHTC and FLTRU, '96-'13 FLHTCU and '09-'13 FLHTCUTG models. Also fits '06-'13 Touring models with accessory King Tour-Pak luggage and '98-'13 Touring models with Tour-Pak mounted rear speaker pods. Not for use with Accessory Fitted Liners or Premier Liner.

F. AUXILIARY POWER PORT – SADDLEBAG MOUNT

This convenient power port mounts to the inside wall of the saddlebag, allowing you to charge cell phones and music players in an out-of-site location. Power port features a quick-disconnect plug for use with detachable saddlebags.

69200091 **\$44.95**

Fits models equipped with 12-volt battery (except FXDRS, VRSC™, XG models, or with Throw-Over or Swingarm Bags). Not for use with accessory Fitted Liners or Premier Liner.

Requires separate purchase of Battery Charging Harness P/N 94624-97B, if not already equipped.



F. AUXILIARY POWER PORT – SADDLEBAG MOUNT



G. AUXILIARY POWER PORT – SIDE PANEL MOUNT

Designed to fit into the leading edge of the Touring model's removable side cover, this port provides easy access for 12V plug-in accessories.

69201099 **\$29.95**

Fits '14-later Touring and Trike models. '17-later models require separate purchase of Electrical Connection Kit P/N 69201599A.

91843-97 **\$29.95**

Fits '94-'13 Touring and Trike models.



G. AUXILIARY POWER PORT – SIDE-PANEL MOUNT



H. AUXILIARY POWER PORT – HORN MOUNT

This fuse-protected power port is conveniently located in an easily accessible location just off the horn mount bracket.

69201136 **\$79.95**

Fits EFI equipped models equipped with a side-mount horn (except XG and '17-later Touring and Trike models).



H. AUXILIARY POWER PORT – HORN MOUNT



Notice: The prices appearing in this catalog are the manufacturer's suggested retail prices. Actual retail prices may vary.

426 TOURING & TRIKE

Electrical Accessories

A. AUXILIARY POWER PORT – HANDLEBAR MOUNT

Power your cell phone, GPS, portable music player or tire inflator from this handy 12-volt power port. The elegant cast housing features a conventional style power outlet that accepts most 12V automotive power adapter plugs and a pop-top cover to protect the port while not in use.

Fits '15-later XG, '14-later XL, '12-'17 Dyna®, '11-later Softail® (except FXDRS), '14-later Road King® models with either 1" or 7/8" diameter handlebars. '17-later Road King requires separate purchase of Electrical Connection Kit P/N 69201599A. '18-later Softail models require separate purchase of Electrical Connection Kit P/N 69201750.

69200971	Chrome.	\$94.95
69200970	Black.	\$94.95

Fits '12-'17 Dyna, '11-later Softail (except FXDRS) and '14-later Road King models with 1-1/4" diameter handlebars. '17-later Road King requires separate purchase of Electrical Connection Kit P/N 69201599A. '18-later Softail models require separate purchase of Electrical Connection Kit P/N 69201750.

69200855	Chrome.	\$94.95
69200854	Black.	\$94.95

B. CIGARETTE LIGHTER AND SOCKET KIT

Need a light? This complete kit is designed as a direct replacement for stock fairing mounted 12V accessory outlet. Kit includes heat-resistant fairing mounted receptacle, short knob pop out lighter with weather skirt and wire connectors. Not intended to be used as an accessory power outlet.

69200605		\$29.95
-----------------	--	----------------

Fits '14-later Touring and Tri Glide® models equipped with fairing mounted 12V accessory outlet.

C. USB CHARGING ADAPTOR

Charge your cell phone, MP3 players, and other hand-held devices while on the road. Compact Adaptor plugs into standard or accessory 12-volt power ports, and provides a standard USB-style outlet that accepts many phone and music player power cords.

69200357		\$19.95
-----------------	--	----------------

For use with Original Equipment or accessory 12V Auxiliary Power Port.



A. AUXILIARY POWER PORT – HANDLEBAR MOUNT, CHROME



A. AUXILIARY POWER PORT – HANDLEBAR MOUNT, BLACK



B. CIGARETTE LIGHTER AND SOCKET KIT



C. USB CHARGING ADAPTOR

Notice: The prices appearing in this catalog are the manufacturer's suggested retail prices. Actual retail prices may vary.

TOURING & TRIKE 427

Electrical Accessories

D. 54-AMP HIGH OUTPUT CHARGING SYSTEM

The Harley-Davidson® High Output Charging System is engineered to provide 30% more power than the stock system at idle. With 54 amps of output at 4000 rpm, accessories will operate at their peak performance – no more dimming lights, reduced audio performance or under-performing heated gear. This is a recommended installation anytime a multi-amp audio system is installed on the vehicle in order to achieve the full capability of your audio system. It is also recommended when installing heated seats, heated gear and other higher draw powered accessories.

Stock on select CVO™ Touring models, the complete kit includes high performance rotor, stator, voltage regulator and all gaskets and hardware required for installation.

29900028A **\$509.95**
Fits '11-'16 Touring, '10-'16 CVO Touring and '09-'16 Trike models. Stock on '14-'16 FLHTKSE, FLHXSE and FLTRUSE.

E. 45-AMP CHARGING SYSTEM FOR ELECTRA GLIDE® MODELS

Standard equipment on H-D® Touring-style Police motorcycles, this high-output charging system knows how to work for a living. Add more electronics – including lights – on your Electra Glide® model without worrying about whether you've got the juice to back it up.

29999-97B Fits '99-'05 FLHT models. **\$269.95**

Also available: (not shown)

32-AMP HIGH-OUTPUT ALTERNATOR KIT

Stock on all '89-later carbureted 1340 models. 50% increase in amperage for the heavily accessorized motorcycle.

29985-87 **\$249.95**
Fits '84-'88 FLT, FLHT, and FXR (wet clutch) models. (Will not fit '84-'88 Softail®.) Stock on all '89-'95 and some '96-'97 Evolution® 1340-equipped models.

F. VOLTAGE REGULATOR – CHROME

Original Equipment voltage regulators with a sparkling triple-plated chrome finish. Hand-buffed, then copper-, nickel- and chrome-plated, these brilliant chrome-plated regulators are the perfect highlight for any Harley-Davidson® motorcycle.

74622-09 **\$199.95**
Fits '09-'16 Touring and Trike models (except '14-later FLHRSE and FLHTKSE and '15-later FLHXSE and FLTRUSE).

74622-06 Fits '06-'08 Touring models. **\$199.95**

74622-04 Fits '04-'05 Touring models. **\$199.95**



D. 54-AMP HIGH OUTPUT CHARGING SYSTEM



E. 45-AMP CHARGING SYSTEM FOR ELECTRA GLIDE MODELS



F. VOLTAGE REGULATOR – CHROME
TOURING

Notice: The prices appearing in this catalog are the manufacturer's suggested retail prices. Actual retail prices may vary.

428 TOURING & TRIKE

Electrical Accessories

A. AUXILIARY POWER SWITCH KIT – FAIRING MOUNT

Styled to match the Original Equipment fairing dash panel switches. These Auxiliary Power switches allow you to control additional fog lamps, auxiliary lighting, heated gear or electrical accessories with the touch of a finger. Kit includes two auxiliary switches, wire harnesses and installation hardware.

71400129 **\$139.95**

Fits '17-later Electra Glide®, Street Glide®, Road Glide®, Ultra Limited and Tri Glide® models. Does not fit CVO™ models.

71400106 **\$79.95**

Fits '14-'16 Electra Glide, Ultra Limited, Road Glide Ultra and Tri Glide models.

71400105 **\$119.95**

Fits '14-'16 Road Glide, Street Glide and Ultra Limited models. Includes dash switch assembly mount.



A. AUXILIARY POWER SWITCH KIT – FAIRING MOUNT (71400129 SHOWN)

B. ELECTRICAL CONNECTION UPDATE KIT – TOURING

Harness plugs into accessory connector to provide 12-volt power leads. Required to install Heated Grips, XM Radio, Cruiser Amp & Speaker Systems, zūmo® GPS, Digital Oil Pressure Gauge, Garage Door Opener Kits, Heated Seats, decorative lighting or other electrical accessories.

69201599A **\$34.95**

Fits '18-later Softtail® models and '17-later Touring and Trike models.

69200722 **\$29.95**

Fits '14-'16 Touring and Trike models.



A. AUXILIARY POWER SWITCH KIT – FAIRING MOUNT (71400105 SHOWN)

C. SWITCHED CIRCUIT ADAPTER HARNESS

This harness allows two accessories to be connected to the switched accessory circuit featured on '94-later Touring models. You then may switch two accessories on or off simultaneously as required.

70264-94A **\$19.95**

Fits '94-later Touring and Trike models. Required on '14-later Touring and Trike models when connecting multiple powered accessories using Electrical Connection Kit P/N 69200722, 71400129, or 69201599A.

69201706 **\$24.95**

Fits '18-later Softtail models and '17-later Touring and Trike models. Required when connecting the CoolFlow™ Fan and another powered accessory using Electrical Connection Kit P/N 69201599A.

Also available:

ELECTRICAL ACCESSORY ADAPTER

Harness accommodates the addition of multiple electrical accessories to the main battery power circuit on specified models.

70270-04A **\$15.95**

Fits '07-later VRSC™, '04-'13 XL and XR, '04-'11 Dyna®, '04-'10 Softtail and '04-'13 Touring models. Also fits '14-later Touring and Trike models when equipped with a third or fourth pair of Boom!™ Audio Stage II speakers.



B. ELECTRICAL CONNECTION UPDATE KIT – TOURING (69201599A SHOWN)

B. ELECTRICAL CONNECTION UPDATE KIT – TOURING (69200722 SHOWN)

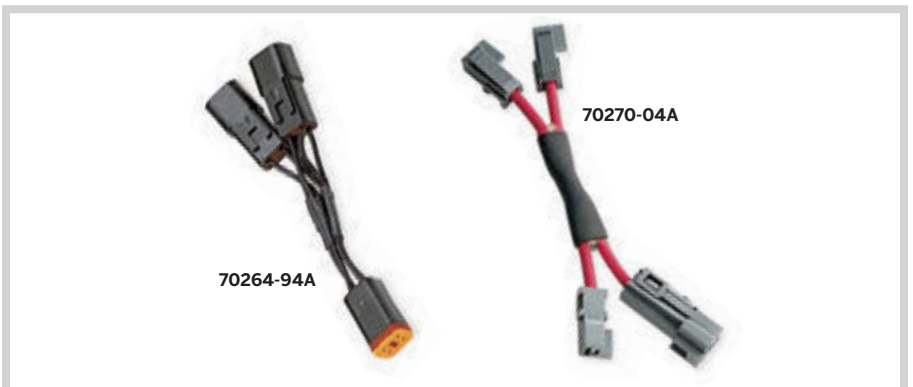

C. SWITCHED CIRCUIT ADAPTER HARNESS & ELECTRICAL ACCESSORY ADAPTER

Notice: The prices appearing in this catalog are the manufacturer's suggested retail prices. Actual retail prices may vary.

TOURING & TRIKE 429

Paint Protection



D. TRANSPARENT PAINT GUARD KITS, SADDLEBAGS – LID

TRANSPARENT PAINT GUARD KITS

This transparent skin is designed to protect your paint from bugs, boot scuffs and road debris. The crystal-clear material protects the paint without changing the overall look of your bike. And the optical properties of the material disguise minor scuffs and scratches. The application process is similar to that of tinted window film and the material can be removed and replaced when it is no longer cosmetically appealing. Scratches to paint can be expensive to repair but scratches to this film can be removed by applying a small amount of heat with a heat gun.

D. SADDLEBAGS – LID

11100098 **\$79.95**

Fits '14-later Touring models with Color-Matched Hard Saddlebags. Does not fit models with leather-covered bags, or Boom!™ Audio Speaker Lids. Not recommended for use on denim or aftermarket paint.

E. TOURING SIDE COVERS

11100078 **\$39.95**

Fits '97-later Touring models. Not recommended for use on denim or aftermarket paint.

Also available: (not shown)

SADDLEBAGS – FRONT

11100097 **\$49.95**

Fits '14-later Touring models with Color-Matched Hard Saddlebags. Does not fit models with leather-covered bags. Not recommended for use on denim or aftermarket paint.

FRONT FENDER

11100080 **\$39.95**

Fits FLD, most FL Softail® (except Springer™), Touring, FLHTCUTG and FLHXXX models. Not recommended for use on denim or aftermarket paint.

F. TRANSPARENT PAINT GUARD KIT – TRIKE

This transparent skin is designed to protect parts of the Trike bodywork from boot scuffs and road debris. The crystal-clear material protects the area surrounding the passenger foot-board and are pre-cut to fit the leading and inner surface of the rear fender, the fascia panel of the trunk and the side covers. Scratches in the material can be "healed" by applying a small amount of heat with a heat gun. The application process is similar to that of tinted window film and the material can be removed and replaced when it is no longer cosmetically appealing.

83989-10A **\$134.95**

Fits '09-later FLHTCUTG and '10-'11 FLHXXX models. Not recommended for use on denim or aftermarket paint.

11100125 **\$134.95**

Fits '15-later FLRT models. Not recommended for use on denim or aftermarket paint.

G. FAIRING BRA – BATWING FAIRING

Offering a custom look and protection from the elements for your fairing, this Fairing Bra is made with non-abrasive, fleece-backed vinyl material and features a Bar & Shield logo. It is designed for easy installation and a custom fit.

57000307 **\$109.95**

Fits '14-later Electra Glide®, Street Glide®, Ultra Limited and Tri Glide® models.

57800-00 **\$109.95**

Fits '96-'13 Electra Glide, Street Glide and Trike models. Requires separate purchase of Chrome Windshield Trim P/N 59213-96.



D. TRANSPARENT PAINT GUARD KITS, SADDLEBAGS – LID '14-LATER MODELS

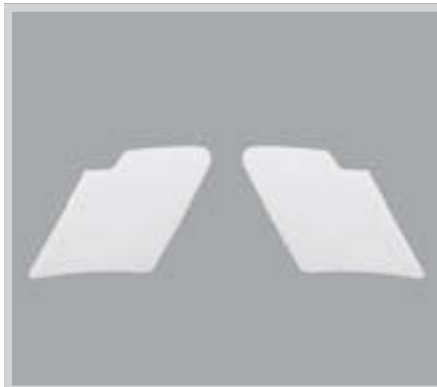

E. TRANSPARENT PAINT GUARD KITS – TOURING SIDE COVERS



F. TRANSPARENT PAINT GUARD KIT (83989-10A SHOWN)



F. TRANSPARENT PAINT GUARD KIT (11100125 SHOWN)



G. FAIRING BRA – BAT WING FAIRING (57000307 SHOWN)



G. FAIRING BRA – BAT WING FAIRING (57800-00 SHOWN)













Notice: The prices appearing in this catalog are the manufacturer's suggested retail prices. Actual retail prices may vary.

SCREAMIN' EAGLE®

Screamin' Eagle® Performance Stage Kits take performance to the next level with increased acceleration and improved passing power when compared to stock bikes. Everything from enhanced air intakes and engine kits to exhaust components and suspension. Screamin' Eagle® Performance Parts and Accessories will blow minds on and off the road.



STAGE UPGRADES – PATH TO PERFORMANCE

START HERE		CHOOSE FROM BELOW		TO ADD MORE POWER			
STAGE	 <p>STAGE I </p> <p>MOVE MORE AIR & FUEL</p> <p>INTAKE + EXHAUST + TUNING UPGRADE = FOUNDATION FOR ALL FUTURE STAGES</p>	 <p>STAGE II </p> <p>GIVE IT A LIFT</p> <p>STAGE I + CAM UPGRADE</p>	 <p>STAGE III </p> <p>PUMP UP THE VOLUME</p> <p>STAGE II + BIG BORE CYLINDERS & PISTONS</p>	 <p>STAGE IV </p> <p>TOP IT OFF</p> <p>STAGE III + CYLINDER HEADS & THROTTLE BODY</p>			
	BENEFITS	<p>TORQUE KIT: Ideal for riders looking for instant passing power at cruising speeds</p> <p>POWER KIT: Ideal for riders who want to feel the power build and pull all the way to the redline</p>		<p>Ideal for riders who want the largest engine displacement and increased power throughout the entire RPM range</p>		<p>Ideal for riders who want the absolute best Harley-Davidson performance upgrade available</p>	
		BASICS	<ul style="list-style-type: none"> • Most cost-effective step to improve performance and the foundation for future performance upgrades • Match any Screamin' Eagle® high-flow air cleaner and exhaust with the proper ECM calibration to increase the air flow into and out of the engine 		<ul style="list-style-type: none"> • Choose a TORQUE CAM or POWER CAM based on riding style • A performance cam increase both the lift in the valve train (pushing the valve open further) and the duration of the valve opening (how long the valve stays open) 		<ul style="list-style-type: none"> • An increase in engine displacement allows the engine to swallow more air and fuel, while a higher compression piston squeezes the air and fuel into a more volatile mixture, generating more power when ignited • Displacement increases are accomplished with larger cylinders, matching pistons and the proper cam upgrade
	PERFORMANCE		 <p>The rider will feel up to a 10%* increase in performance when compared to stock bikes throughout the entire RPM range</p>		 <p>TORQUE</p> <ul style="list-style-type: none"> • TORQUE KIT: The rider will feel up to a 15%* increase in performance when compared to stock bikes in the low- to mid-RPM range • Experience crisp throttle response and acceleration that can be felt at slower speeds, perfect for passing slow moving vehicles without downshifting 	 <p>POWER</p> <ul style="list-style-type: none"> • POWER KIT: The rider will feel up to a 25%* increase in performance when compared to stock bikes in the mid-RPM to upper RPM range • Experience an adrenaline-pumping burst of speed while heading toward the redline 	 <ul style="list-style-type: none"> • Riders will experience a performance increase throughout the entire RPM range, with up to a 35%* increase when compared to stock bikes in the mid- to upper-RPM range • Produces instant passing power without downshifting • Delivers excellent stoplight to freeway speed and on-ramp acceleration

AN OVERVIEW OF WARRANTY & CAUTION: Harley-Davidson has the engineering expertise, sophisticated dyno lab and complete testing facilities to provide enthusiasts with a line of performance products designed to produce good, solid, reliable horsepower and torque. Engine-related performance parts are intended for the experienced rider only.

WARRANTY: Installation of Screamin' Eagle® products and similar off-road or competition products from other manufacturers, except some street-compliant offerings installed by authorized Harley® dealers, may void your H-D® limited vehicle warranty. Installation of a California performance kit on a 49-state model motorcycle or 49-state performance kit onto a California model motorcycle will void the manufacturer's warranty, as it will not result in a street-compliant configuration.

CAUTION: Harley-Davidson® motorcycles modified with some Screamin' Eagle® high-performance engine parts must not be used on public roads and, in some cases, may be restricted to closed-course competition.

CAUTION ICONS

GO LIGHT: These Screamin' Eagle® products are 50-state U.S. EPA compliant for sale and use on all applicable vehicles, including those that are pollution controlled. See Genuine Motor Parts and Accessories or Screamin' Eagle Accessories catalog for fitment information. Screamin' Eagle Performance products are intended for the experienced rider only.

STOP HAND: Harley-Davidson® motorcycles modified with some Screamin' Eagle® Performance products must not be used on public roads and, in some cases, may be restricted to closed-course competition. These performance parts are 49-state U.S. EPA compliant but are NOT compliant for sale or use in California on pollution-controlled motor vehicles. California guidelines on tampering can also lead to substantial fines and penalties. Screamin' Eagle® Performance products are intended for the experienced rider only.

CALIFORNIA: These Screamin' Eagle® products are street compliant for sale and use on pollution-controlled vehicles in the state of California.

CROSS FLAGS: This product may be intended for race use only applications. It may also be certified for use in a 50-state U.S. EPA compliant application or kit. Use of any incomplete combination of certified kit products may not be legal for sale or use on U.S. market-pollution controlled vehicles and may be restricted to closed course competition use. See Genuine Motor Parts and Accessories or Screamin' Eagle® Accessories catalog for compliance, fitment and warranty information. Screamin' Eagle® Performance products are intended for the experienced rider only.

DYNAMOMETER (DYNO) PERFORMANCE TESTING: Declared performance values in this catalog represent SAE J-1349 transient peak power output. Dynamometer settings, motorcycle condition, variation, climate and other factors can affect performance output, and results can vary from the performance values declared by Harley-Davidson.

Street-legal and/or street-compliant statements refer to product meeting 50-state emissions and noise standards in the United States. The street legal and/or street compliant statements may not apply to markets outside of the United States

Not all products are available in all countries — please consult your dealer for details.

Stage upgrades retain the Motorcycle Original Equipment Manufacturer's Warranty.

*Dynamometer settings, motorcycle condition, variation, climate and other factors can affect performance output, and results can vary from the performance values declared by Harley-Davidson.

TUNING FOR PERFORMANCE: THE BASICS

First things first, you've built your dream pavement-pounding machine by selecting one of the Screamin' Eagle® Stage upgrades.



STAGE I



STAGE II



STAGE III



STAGE IV

1

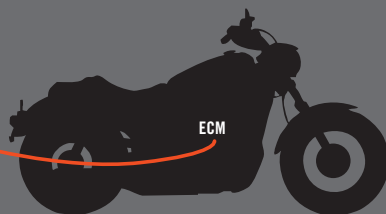

Next, the motorcycle Engine Control Module (ECM) needs to be recalibrated. Screamin' Eagle® offers base calibrations specifically designed for the performance components on your bike.

2

Tuning adjusts the air-fuel ratio and other parameters based on your performance upgrades.

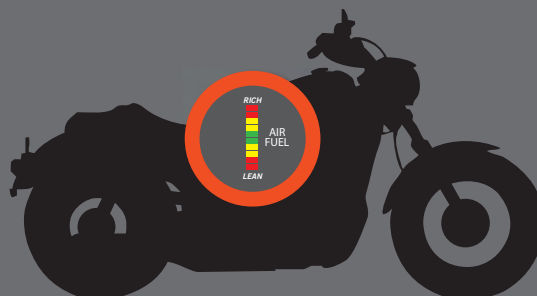

3

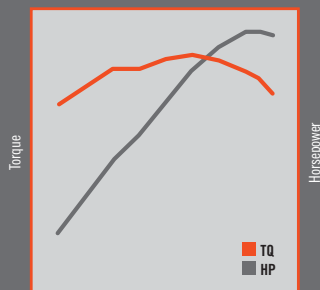

MAXIMUM PERFORMANCE

The end result? A properly tuned performance machine that gets the most out of your performance upgrades.

START HERE:

WANT MORE?

THE BASICS

THE HOW

THE WHAT

THE BENEFIT

PRO STREET TUNER



- Offers base calibrations for your chosen Screamin' Eagle® Stage upgrade
- Constantly monitors the engine operation in the Part-Throttle Cruising Range
- Enables manual adjustments to fine-tune parameters within part-and full-throttle ranges

- 1 Load base calibration
- 2 All done, go ride or manually adjust with Dyno tuning or Smart Tune Live

COMPLETE MOTORCYCLE OPERATING RANGE

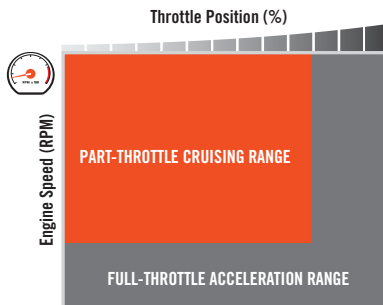

PART THROTTLE CRUISING RANGE

Pro Street Tuner Base Calibration + Original Equipment Narrowband O₂ Sensors monitor exhaust for proper operation in the Part-Throttle Cruising Range

FULL THROTTLE ACCELERATION RANGE

Original Equipment Narrowband O₂ Sensors cannot measure or adjust in this range; requires manual adjustments to reference data tables to provide tuning information

MANUAL ADJUSTMENT FOR
Maximum Performance + Optimal Efficiency for your bike



ADD SMART TUNE PRO



- Uses the Pro Street Tuner base calibrations as a starting point
- Constantly monitors the engine operation and riding conditions in the Complete Motorcycle Operating Range
- Automatically adjusts tuning parameters in real time within the Complete Motorcycle Operating Range

- 1 Load base calibration from Pro Street Tuner
- 2 Install Smart Tune Pro and Wideband O₂ Sensors onto motorcycle
- 3 All done, go ride. Smart Tune Pro automatically does the rest!

COMPLETE MOTORCYCLE OPERATING RANGE

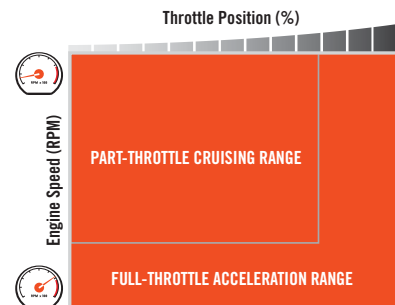

COMPLETE MOTORCYCLE OPERATING RANGE

Pro Street Tuner Base Calibration + Smart Tune Pro + Wideband O₂ Sensors automatically monitor and adjust the engine in real time for all performance upgrades, operating ranges and riding conditions

AUTOMATIC ADJUSTMENT FOR
Maximum Performance + Optimal Efficiency
+ Automatic Adjustment for your bike
in all riding conditions and combinations of performance upgrades



PRO STREET TUNER

All Screamin' Eagle® performance upgrades require Engine Control Module (ECM) recalibration, also known as tuning. The best method for tuning your stage upgrades is with the Screamin' Eagle Pro Street Tuner.

- Provides starting calibrations developed by the Screamin' Eagle team
- Offers ability to dial in bike-to-bike variations and different air cleaner and exhaust combinations
- Offers Guided Smart Tune process which walks user through tuning with or without a dyno
- Allows adjustments within a safe range for optimum performance excitement
- Maximizes the performance output while maintaining 50-state U.S. EPA compliance
- Retains the Motorcycle Original Equipment Manufacturer's Warranty



SCREAMIN' EAGLE® PRO STREET TUNER

The Screamin' Eagle® Pro Street Performance Tuner is designed to simplify management of engine operating parameters as performance modifications are made. Once installed, the kit will allow you to adjust key parameters or simply upload the latest Engine Control Module (ECM) calibrations to match your bike's state-of-tune. Start with a high-flow air cleaner and Street Performance mufflers and upload the calibration that provides the best performance mix. Add additional Stage Upgrades later, and you simply upload the proper ECM calibration to match the model and hardware. Plus, you have free online access to the latest factory calibrations.

Ideal for real-world street performance applications, the Pro Street Tuner provides the adjustability to account for bike-to-bike variation and for changes to cams, heads, intake and exhaust while maintaining closed-loop fuel control for fuel economy in the part-throttle operating range. Unlike other aftermarket tuners, The Screamin' Eagle Pro Street Tuner actually talks directly to your motorcycle's ECM and re-programs the motorcycle's operating system. It isn't a piggyback system that tries to fool the ECM into adding more fuel or changing the ignition timing. The Pro Street Tuner plugs into the bike's data port, so no splicing or under-seat hardware is required.

After you upload the proper ECM calibration, dial it in with the Smart Tune function. The guided Smart Tune process walks you through the process to: find the right calibration for your build, set the tuner to a data collection mode and then allows you to incorporate the data after the ride with just a few clicks. The ECM calibration is then custom fit for your bike. The module will store up to 15 minutes of run-time data information that can be downloaded to your PC, allowing the rider or technician to view and evaluate the bike's air/fuel ratio, O₂ sensor readings, engine speed and temperature, RPM and vehicle speed, throttle position, spark advance and many more performance characteristics. The Vehicle Communications Module (VCI) will also record and display service codes for troubleshooting and diagnostics. The kit includes the VCI module and unlimited access to the latest software updates and calibrations available from Screamin' Eagle. Tuner Cable kit sold separately.

The Pro Street Tuner software includes impressive features:

- Features a guided Smart Tune process to enable quick navigation through the software, whether you are new to tuning or an experienced user.
- Smart Tune Live – a dynamic and visual method to track and capture engine data simply by running the vehicle through a range of RPM and throttle positions. This feature reduces the time to modify existing VE (Volumetric Efficiency) tables which are then analyzed and tuned. Smart Tune Live works on models with factory-installed O₂ sensors only.
- Adjustability to Spark Advance, Throttle progressivity, and Volumetric Efficiency to custom tune the performance combination.
- 50-State U.S. EPA compliant.

The Pro Street Tuner permits tunability to optimize performance and drivability without compromising fuel efficiency, emission levels, engine durability, or 50-State U.S. EPA compliance. And unlike other race tuners or engine controllers, the Screamin' Eagle Pro Street Tuner does not impact your Harley-Davidson factory warranty coverage.

4100008C \$299.95
 For use with '17-later XG, '14-later XL and '07-'17 Dyna®, and '07-later Softail® and Touring and '17-later Trike models. Requires separate purchase of model-specific Tuner Cable. **Screamin' Eagle performance upgrades for FLSB are 49-state U.S. EPA approved. Pending approval for use in California.**

FEATURES

	PRO STREET TUNER
Street-Use (EPA/CARB) Calibrations	Yes – Stage 1, 2, 3 & 4
SE Pro (Race-Use Only) Calibrations	No
Retains Full Engine Warranty	Yes
Tuning Parameters:	
<i>Volumetric Efficiency</i>	Tunable – All
<i>Throttle Progressivity</i>	Tunable – '14-later Touring
<i>Spark Advance – Tunable</i>	'17-later XG '14-later XL '12-'17 Dyna '12-later Softail '14-later Touring
<i>RPM Max</i>	View Only
<i>Idle RPM</i>	View Only
<i>Accel Enrichment</i>	View Only
<i>Decel Enleanment</i>	View Only
Data Recording	15 minutes
Smart Tune LIVE	Yes
Graphical Data Display	Yes
Service Codes Display/Clear	Yes
Available for VRSC™ and XR models	No
Language Support	English, Spanish, German, French, Japanese, Italian, Portuguese, Dutch

Also available:

SCREAMIN' EAGLE TUNER CABLE KIT

Cable kit provides all necessary connections between motorcycle, VCI and computer, and permits downloading calibrations with the Street Tuner and Super Tuner software. Kit includes two cables; computer USB to VCI box and VCI box to vehicle.

32184-08A \$45.95

For use with '01-'17 VRSC™, '01-'13 EFI XL and XR, '01-'11 EFI Dyna, '01-'11 EFI Softail, '02-'13 EFI Touring and '09-'13 Trike models. Also for use with VRXSE Destroyer race bikes.

41000018 \$34.95

For use with '15-later XG, '14-later XL, '12-'17 Dyna, '11-later Softail, '14-later Touring and '14-later Trike models. **Screamin' Eagle performance upgrades for FLSB are 49-state U.S. EPA approved. Pending approval for use in California.**

Street legal and/or street compliant statements refer to product meeting 50-State emissions and noise standards in the United States.

The street legal and/or street compliant statements may not apply to markets outside of the United States.

Notice: The prices appearing in this catalog are the manufacturer's suggested retail prices. Actual retail prices may vary.

TUNING FOR PERFORMANCE

START HERE: PRO STREET TUNER

- Base calibrations for each Screamin' Eagle Stage® upgrade
- Constantly monitors the engine operation in the Part Throttle Cruising Range
- Enables MANUAL adjustments to fine-tune parameters within part and full throttle ranges

The result? MANUAL ADJUSTMENT FOR Maximum Performance + Optimal Efficiency

WANT MORE? ADD SMART TUNE PRO

- Uses Pro Street Tuner base calibrations as a starting point
- Constantly monitors engine operation and riding conditions in the Complete Motorcycle Operating Range
- AUTOMATICALLY adjusts tuning parameters in REAL-TIME within the Complete Motorcycle Operating Range

The result? AUTOMATIC ADJUSTMENT FOR Maximum Performance + Optimal Efficiency + Automatic Adjustment for all riding conditions and performance upgrades

*Street legal and/or street compliant statements refer to product meeting 50-State emissions and noise standards in the United States.
The street legal and/or street compliant statements may not apply to markets outside of the United States.*



A. SCREAMIN' EAGLE SMART TUNE PRO AUTOMATIC TUNING MODULE

A. SCREAMIN' EAGLE® SMART TUNE PRO AUTOMATIC TUNING MODULE*

Smart Tune PRO works with the Screamin' Eagle® Pro Street Tuner to automatically adjust your bike for the combination of performance components, climates, and vehicle load conditions you are operating in. You just install the upgraded wide-band oxygen sensors in the exhaust headers, download the calibration that the Screamin' Eagle engineers have developed as a starting point, then simply drive down the road and let Smart Tune Pro do the work.

Smart Tune PRO constantly monitors the operating parameters of your motorcycle, and automatically adjusts the bike's Electronic Control Module (ECM) to maximize performance in your current riding conditions. Smart Tune Pro utilizes wide-band O₂ sensors that read oxygen levels in the exhaust stream to determine the optimum air/fuel ratio your bike needs at this very moment. Smart Tune Pro analyzes the data and automatically makes real-time tuning adjustments to the ECM. Unlike the standard narrow-band O₂ sensors that only provide feedback in the part-throttle cruising range, the wideband sensors can read and adjust tuning throughout the part throttle cruising and full-throttle acceleration operating range.

It is fully factory supported, and optimized to maximize performance while maintaining drivability and engine longevity. Smart Tune PRO is 50-state EPA compliant* and does not impact the H-D factory warranty. Kit includes the Smart Tune PRO module with plug-in wiring harness, two M18 wideband O₂ sensors, and access to free software updates, future calibrations and free on-line training modules. Screamin' Eagle Pro Street Tuner and model-specific installation hardware is sold separately.

41000445 **\$399.95**

Fits '17-later XL, '16-'17 Dyna® FXDLS, '16-later Softail® and '14-later Touring models. Installation requires exhaust modification to incorporate wide-band oxygen sensors. Some models require Oxygen Sensor Harness Extension. For model specific installation requirements see Installation Instructions on H-D.com/shop. All models require ECM calibration with Screamin' Eagle Pro Street Tuner for proper installation. **Screamin' Eagle performance upgrades for FL5B are 49-state U.S. EPA approved. Pending approval for use in California.**

Also available: (not shown)

OXYGEN SENSOR HARNESS EXTENSION

Plug-in extension cable is wired to allow installation of the Screamin' Eagle Smart Tune PRO Automatic Tuning Module hardware on specific models. No splicing or soldering is required.

69201704 **\$29.95**

Required for use of Screamin' Eagle Smart Tune PRO Automatic Tuning Module hardware on, '16-'17 Dyna and Softail models.

438 SCREAMIN' EAGLE®

Milwaukee-Eight® Stage Upgrades

MILWAUKEE-EIGHT® POWERTRAIN

Screamin' Eagle® Stage upgrades offer complete street-compliant performance configurations engineered to generate specific torque and horsepower gains. Eliminating all the guesswork and trial-and-error testing normally associated with engine modifications, Stage upgrades include everything you need to enhance your bike's performance. Start with the foundation, the Stage 1 upgrade, then choose from Stage II, III or IV depending on your performance goals, budget and riding style.



STAGE I

INTAKE + EXHAUST + TUNING

The easiest and most cost effective step to improve your motorcycle's performance is to increase the air flow into and out of the engine. A high-flow air cleaner and system-matched slip-on mufflers provide horsepower and torque improvements you can feel throughout the RPM range, and serve as the core components for all performance upgrades. ECM calibration is required to tune the fuel flow and timing required to accommodate the improved air flow.

Stage I upgrade can be installed without engine disassembly. No special tools are required. Requires ECM tuning.



*Street legal and/or street compliant statements refer to product meeting 50-State emissions and noise standards in the United States.
The street legal and/or street compliant statements may not apply to markets outside of the United States.*

STAGE II

STAGE I + CAM UPGRADE

Adding performance cams to a Stage I equipped bike is the next step to improved performance. Cam choices allow you to tailor the engine's performance to your specific needs. A torque cam offers on-demand throttle response from low- to mid-RPM at cruising speed. A power cam targets high-rpm, wide-open throttle response that keeps pulling right up to the redline. ECM calibration tuning is required to accommodate the increased valve timing, and performance valve springs may be required for high-lift cams.

Stage II upgrade requires minor engine disassembly to replace the cam. Adjustable pushrods allow cam installation without removing the rocker box. Special tools and ECM tuning are required.



STAGE III

STAGE I + CAM, BIG BORE CYLINDERS & PISTONS

The next step on the performance journey is to build a bigger engine. An increase in engine displacement allows the engine to swallow more air and fuel, a higher compression piston squeezes the air/fuel into a more volatile mixture, and when combined, generates more power when ignited. A displacement and compression increase provides torque increases throughout the entire RPM range with a 15-25% improvement in the mid-range power. ECM calibration tuning is required to adjust fuel flow and timing to accommodate the increased displacement.

Stage III bolt-on upgrade requires removal of the engine's top-end and opening the cam chest. Engine remains in the chassis and no machining is required. Special tools and ECM tuning are required.



STAGE IV

STAGE I + CAM, BIG BORE CYLINDERS, PISTONS, CYLINDER HEADS & THROTTLE BODY

To maximize the impact of the increased displacement gained with Stage III updates, the addition of free-flowing ported cylinder heads and a big bore throttle body top off the performance build. Designed to satisfy the high RPM, throttle twisting rider, the Stage IV update delivers 20-30% increase in power that keeps pulling right up to the redline, without sacrificing mid-range torque. ECM calibration tuning is required to add more fuel, and a higher-lift cam may be required to deliver maximum power.

Stage IV bolt-on upgrade requires removal of the engine's top-end and opening the cam chest. Engine remains in the chassis and no machining is required. Special tools and ECM tuning are required.



SCREAMIN' EAGLE

MILWAUKEE-EIGHT® POWERTRAIN

Screamin' Eagle® Stage upgrades offer complete street-compliant performance configurations. Whether you're a Softail® or Touring rider, Screamin' Eagle offers the full gammut of Stage upgrades for you to pick the best solution for you. Use the Rear Wheel Horsepower and Torque charts to identify a combination that would work best for your riding style and performance needs.

SOFTAIL® 107CI MODEL STAGE UPGRADES

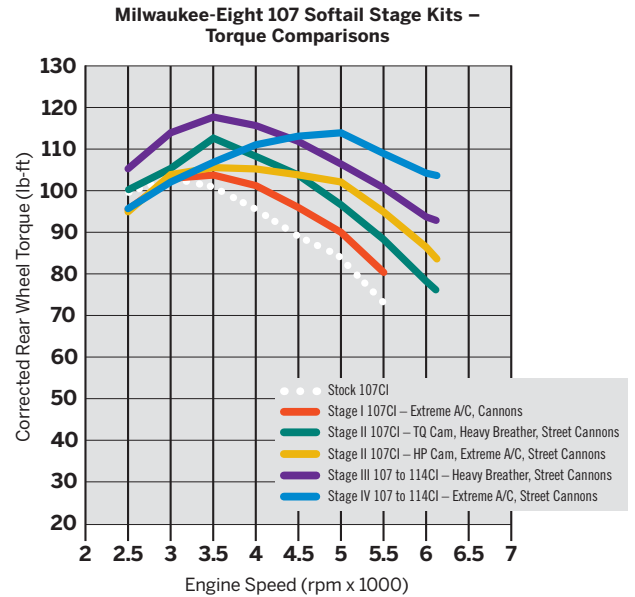
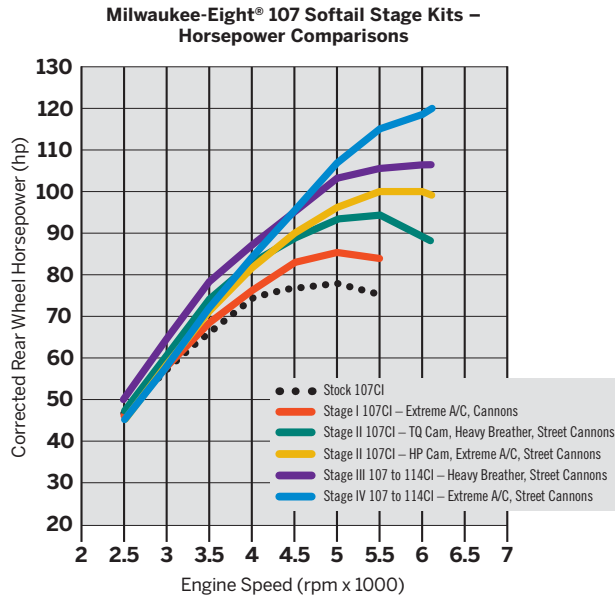

SOFTAIL 114CI MODEL STAGE UPGRADES

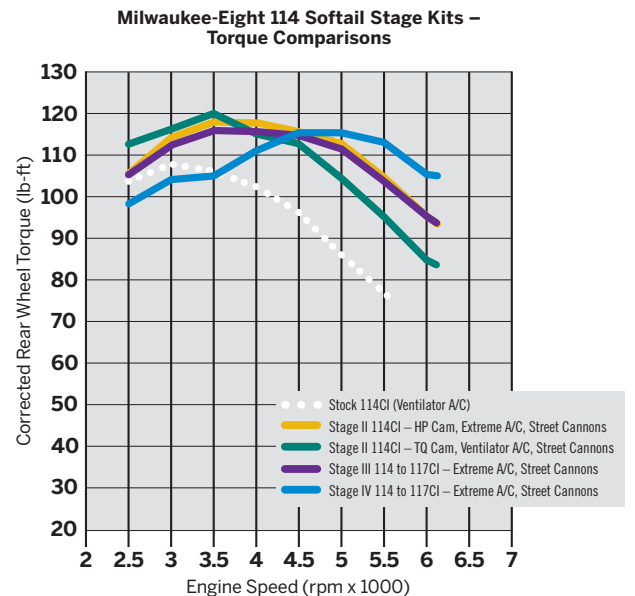
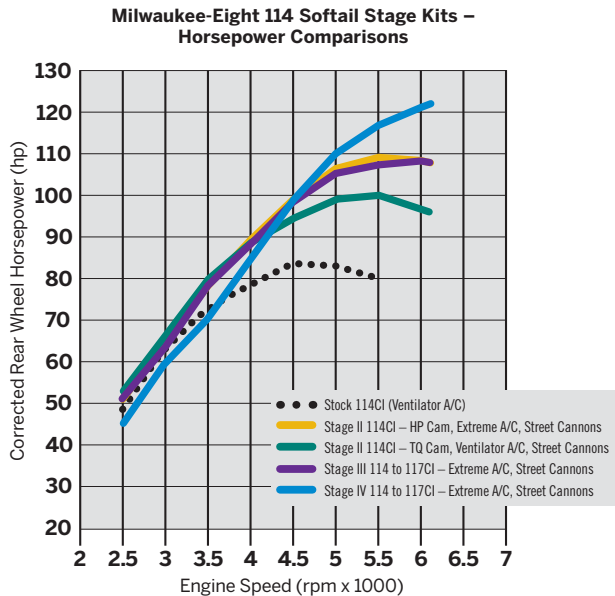

Street legal and/or street compliant statements refer to product meeting 50-State emissions and noise standards in the United States. The street legal and/or street compliant statements may not apply to markets outside of the United States.

TOURING 107CI MODEL STAGE UPGRADES

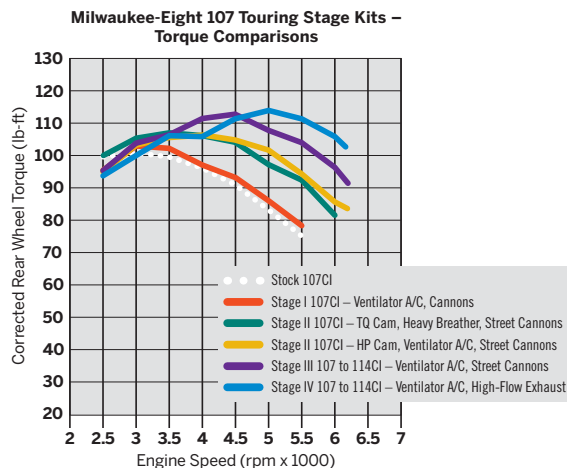
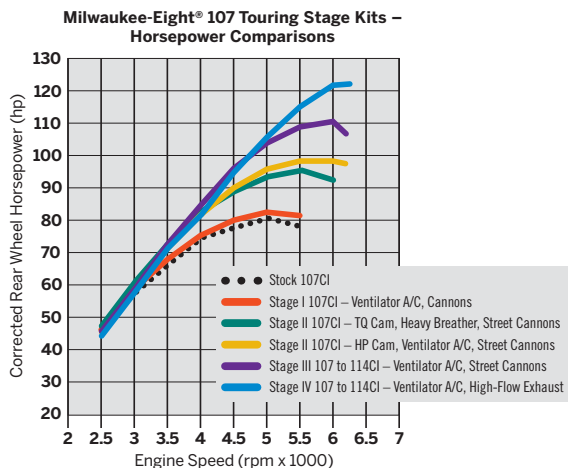

TOURING 114CI MODEL STAGE UPGRADES

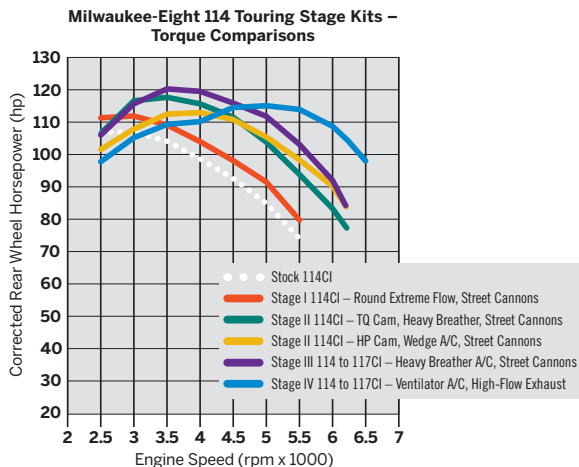
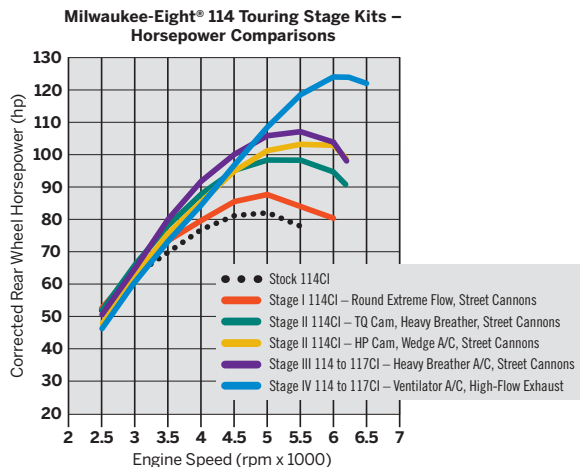

CVO™ TOURING MODEL STAGE UPGRADES

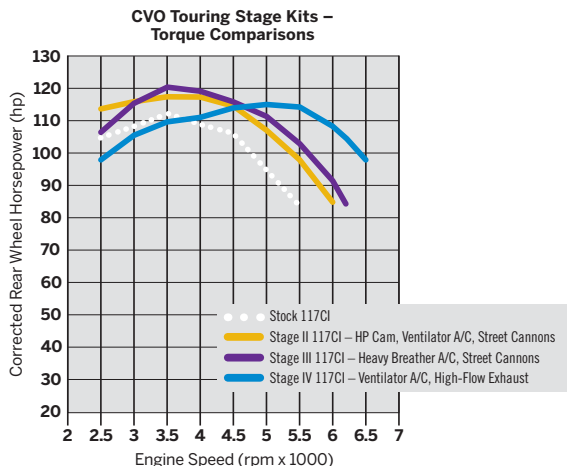
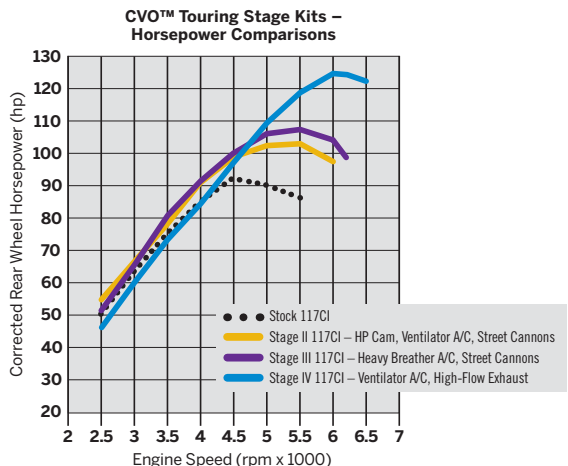

DYNAMOMETER (DYNO) PERFORMANCE TESTING: Declared performance values in this catalog represent SAE J-1349 transient peak power output. Dynamometer settings, motorcycle condition, variation, climate and other factors can affect performance output and results can vary from the performance values declared by Harley-Davidson.

Street legal and/or street compliant statements refer to product meeting 50-State emissions and noise standards in the United States. The street legal and/or street compliant statements may not apply to markets outside of the United States.

MILWAUKEE-EIGHT® ENGINE STAGE I BASICS

Stage I upgrades are the foundation for further Milwaukee-Eight® Engine upgrades. They are ideal for riders that want to enhance the bike's performance, look and sound. No engine disassembly or special tools are required for Stage I upgrades. Match any Screamin' Eagle® high-flow air cleaner and exhaust, along with the proper ECM calibration to increase the air flow into and out of the engine. The rider will feel up to 10%* increase in performance over stock throughout the entire RPM range.

MILWAUKEE-EIGHT ENGINE STAGE I

INSTALLATION 



INTAKE + EXHAUST + TUNING UPGRADE = FOUNDATION FOR ALL FUTURE STAGES

"I want simple bolt-on performance upgrades that enhance the performance, look and sound of my motorcycle."

STEP 1 CHOOSE YOUR INTAKE

Select between Air Cleaners that allow you to maintain the stock Air Cleaner Cover or upgrade to Air Cleaners featuring stylized covers and/or stylized cover inserts. All Screamin' Eagle Air Cleaners allow for free-breathing and unobstructed airflow to your Milwaukee-Eight engine.

More airflow equals more power.

STEP 2 SELECT YOUR EXHAUST

Screamin' Eagle® exhaust is dialed in to enhance the performance of your Milwaukee-Eight engine and when paired with a free-flowing air cleaner and proper tuning, delivers horsepower and torque gains you can feel. Select from 3.5" or 4.5" Street Cannon Slip-On Mufflers for various Softail® and Touring models or a 4.5" High-Flow Exhaust with Street Cannon Slip-On Mufflers for Touring models. Both the Street Cannon Slip-Ons and the High-Flow Exhaust systems provide a rich exhaust note with a deep base rumble and a throaty tone on acceleration while reducing unwanted tones with a premium fiberglass packing. The High-Flow Exhaust also includes a large diameter, high-flow catalyst for a free flowing system that does not impede performance.

STEP 3 UPGRADE YOUR ECM

When upgrading your intake and exhaust, you must recalibrate your Engine Control Module (ECM), also known as tuning. Start with the Screamin' Eagle Pro Street Tuner. This tuner offers base calibrations for your Stage upgrade, constant monitoring of the engine operation in the Part Throttle Cruising Range and, enables manual adjustments to fine-tune parameters within part and full throttle ranges. The Pro Street Tuner provides manual adjustment for maximum performance and optimal efficiency for your bike.

STEP 4 TAKE IT TO THE NEXT LEVEL

Don't want to fuss with manual adjustments? Let the Smart Tune Pro do it for you. Using the Pro Street Tuner base calibrations as a starting point, the Smart Tune Pro automatically adjusts tuning parameters in real-time within the complete motorcycle operation range. Smart Tune Pro provides automatic adjustment for maximum performance plus optimal efficiency and automatic adjustment for your bike in all riding conditions and combinations of performance upgrades.



* Dynamometer settings, motorcycle condition, variation, climate and other factors can affect performance output and can vary from the performance values declared by Harley-Davidson. 50-State street-compliant stage upgrades retain the Motorcycle Original Equipment Manufacturer's Warranty

SCREAMIN' EAGLE® 443

Milwaukee-Eight® Stage I Upgrade



A. SCREAMIN' EAGLE HEAVY BREATHER PERFORMANCE AIR CLEANER – MILWAUKEE-EIGHT – CHROME



A. SCREAMIN' EAGLE HEAVY BREATHER PERFORMANCE AIR CLEANER – MILWAUKEE-EIGHT – GLOSS BLACK



A. SCREAMIN' EAGLE HEAVY BREATHER PERFORMANCE AIR CLEANER – MILWAUKEE-EIGHT – CHROME



A. SCREAMIN' EAGLE HEAVY BREATHER PERFORMANCE AIR CLEANER – MILWAUKEE-EIGHT – GLOSS BLACK



B. SCREAMIN' EAGLE HEAVY BREATHER BILLET ALUMINUM FILTER COVER – GLOSS BLACK



A. SCREAMIN' EAGLE® HEAVY BREATHER PERFORMANCE AIR CLEANER – MILWAUKEE-EIGHT® ENGINE

Take a deep breath. Designed in concert with the Milwaukee-Eight® powertrain, the iconic Heavy Breather Air Cleaner features a forward facing oiled cotton filter element that flows large volumes of clean air into the engine. The short, low-profile cast tube rams the charge directly into the throttle body with little turbulence for increased power and torque, and the intake tube mounts to a custom back plate that features integral breathers and covers the throttle body and electronics for a finished look. The slanted compact filter adds an aggressive performance look, and it is shaped to allow installation on Touring bikes equipped with fairing lowers. Available in your choice of chrome or gloss black finish, the kit includes filter, intake tube, custom back plate, water-repellent rain sock and all mounting hardware. 50-State U.S. EPA compliant.

Fits '18-later Softail®, and '17-later Touring and Trike models. Does not fit with Fairing Lower Speakers. All models require ECM calibration with Screamin' Eagle® Pro Street Tuner for proper installation. ECE compliant on '17-later CVO™ Touring and 107CI Twin-Cooled™ models. **Screamin' Eagle performance upgrades for FLSB are 49-state U.S. EPA approved. Pending approval for use in California.**

29400263	Chrome.	\$399.95
29400264	Gloss Black.	\$399.95

B. SCREAMIN' EAGLE HEAVY BREATHER BILLET ALUMINUM FILTER COVER

This two-piece billet cover adds dimension to your Milwaukee-Eight Heavy Breather. Manufactured from forged aluminum and precision machined to tightly wrap the element, this stylish cover exposes a majority of the filter to maximize airflow. The cover can be installed on Touring models equipped with fairing lowers, and can be used with the Original Equipment Heavy Breather Rain Sock. The cover features a deep machined Screamin' Eagle logo, and is available in a rich, gloss black finish.

61300688	Gloss Black.	\$199.95
-----------------	--------------	-----------------

Fits '18-later Softail, and '17-later Touring and Trike models equipped with Heavy Breather Air Cleaner P/N 29400263 or 29400264.

SCREAMIN' EAGLE

Street legal and/or street compliant statements refer to product meeting 50-State emissions and noise standards in the United States.

The street legal and/or street compliant statements may not apply to markets outside of the United States.

Notice: The prices appearing in this catalog are the manufacturer's suggested retail prices. Actual retail prices may vary.

444 SCREAMIN' EAGLE®

Milwaukee-Eight® Stage I Upgrade

A. SCREAMIN' EAGLE® VENTILATOR AIR CLEANER KIT – MILWAUKEE-EIGHT® ENGINE

This low-profile oval air cleaner features an exposed filter element and a cast back plate designed to provide maximum air flow to the throttle body. This easy-to-install air cleaner produces significant performance gains, while the stylish cover is tapered for added leg clearance. This complete kit includes low-profile air cleaner cover, high-flow filter element, cast aluminum back plate, diamond-cut Screamin' Eagle® medallion, and all required installation hardware. Protective Rain Sock is included. 50-State U.S. EPA compliant.

Fits '18-later Softail®, and '17-later Touring and Trike models. All models require ECM calibration with Screamin' Eagle Pro Street Tuner for proper installation. ECE compliant on '17-later CVO™ Touring models. **Screamin' Eagle performance upgrades for FLSB are 49-state U.S. EPA approved. Pending approval for use in California.**

29400299	Chrome.	\$299.95
29400298	Gloss Black.	\$299.95



A. SCREAMIN' EAGLE VENTILATOR AIR CLEANER KIT – MILWAUKEE-EIGHT – CHROME

B. DEFIANCE COLLECTION VENTILATOR AIR CLEANER TRIM – MILWAUKEE-EIGHT ENGINE

This forged and machined Defiance Air Cleaner Trim kit adds a premium touch to the Milwaukee-Eight® Ventilator Air Cleaner. The billet-style band with deep longitudinal lines and H-D logo wraps the center section of the Ventilator Air Cleaner face plate for a contemporary look. The Defiance Air Cleaner Trim is available in your choice of chrome, machine cut anodized black or full black finishes. Kit includes trim band and mounting hardware. Protective Rain Sock P/N 29400177 or 29762-09 is available separately.

Fits '18-later Softail, and '17-later Touring and Trike models equipped with Ventilator Air Cleaner P/N 29400298 or 29400299. Also fits '18-later Softail models with 114CI engines and '17-later CVO touring models with Original Equipment Ventilator Air Cleaner with separate purchase of Air Filter P/N 29400293.

61300768	Chrome.	\$134.95
61300769	Gloss Black Anodized.	\$134.95
61300770	Gloss Black with Highlights.	\$149.95



A. SCREAMIN' EAGLE VENTILATOR AIR CLEANER KIT – MILWAUKEE-EIGHT – GLOSS BLACK



A. SCREAMIN' EAGLE VENTILATOR AIR CLEANER KIT – MILWAUKEE-EIGHT – BLACK



B. DEFIANCE COLLECTION VENTILATOR AIR CLEANER TRIM – MILWAUKEE-EIGHT – CHROME



B. DEFIANCE COLLECTION VENTILATOR AIR CLEANER TRIM – MILWAUKEE-EIGHT – GLOSS BLACK



B. DEFIANCE COLLECTION VENTILATOR AIR CLEANER TRIM – MILWAUKEE-EIGHT – GLOSS BLACK WITH HIGHLIGHTS



B. DEFIANCE COLLECTION VENTILATOR AIR CLEANER TRIM – MILWAUKEE-EIGHT

Street legal and/or street compliant statements refer to product meeting 50-State emissions and noise standards in the United States.

The street legal and/or street compliant statements may not apply to markets outside of the United States.

Notice: The prices appearing in this catalog are the manufacturer's suggested retail prices. Actual retail prices may vary.



C. SCREAMIN' EAGLE WEDGE HIGH-FLOW AIR CLEANER

SCREAMIN' EAGLE® 445

Milwaukee-Eight® Stage I Upgrade

C. SCREAMIN' EAGLE® WEDGE HIGH-FLOW AIR CLEANER



Screamin' Eagle® High-Flow Air Cleaner Kits allow free breathing and unobstructed airflow to your Milwaukee-Eight® engine – while maintaining a subtle Original Equipment look. These kits feature a die-cast back plate sized to provide an open-element function that permits airflow around the entire perimeter of the air cleaner and through the ram air opening at the front. Your engine gets more air, and you feel more power throughout the rev range. Kit includes the die-cast back plate, a high-flow oiled-cotton filter element, all required installation gaskets and hardware and a diamond-cut Screamin' Eagle medallion to finish the look. Kits are available with your choice of chrome or textured black back plate to match your customizing style. 50-State U.S. EPA compliant.

Fits '17-later Touring and Trike models. Not compatible with air cleaner cover on CVO™ Touring models. All models require ECM calibration with Screamin' Eagle Pro Street Tuner for proper installation. ECE compliant on '17-later CVO Touring models.

29400246A	Chrome.	\$189.95
29400245A	Black.	\$179.95

Also available:

SCREAMIN' EAGLE AIR CLEANER MEDALLION – MILWAUKEE-EIGHT

Dress your factory air cleaner cover with a diamond cut Screamin' Eagle medallion. Lock patch holds the medallion firmly in place and is easy to remove for access to the air cleaner hardware.

61300762	\$19.95
-----------------	----------------

Fits '17-later Touring and Trike models equipped with Original Equipment wedge air cleaner cover. Does not fit CVO models.



C. SCREAMIN' EAGLE WEDGE HIGH-FLOW AIR CLEANER – CHROME



C. SCREAMIN' EAGLE WEDGE HIGH-FLOW AIR CLEANER – BLACK



SCREAMIN' EAGLE

Street legal and/or street compliant statements refer to product meeting 50-State emissions and noise standards in the United States.

The street legal and/or street compliant statements may not apply to markets outside of the United States.

Notice: The prices appearing in this catalog are the manufacturer's suggested retail prices. Actual retail prices may vary.

446 SCREAMIN' EAGLE®

Milwaukee-Eight® Stage I Upgrade

A. SCREAMIN' EAGLE® ROUND EXTREME-FLOW AIR CLEANER – CENTER BOLT

The open-face filter design of the Screamin' Eagle® Extreme-Flow Air Cleaner Kit provides 60% more filtered surface area to flow 11% more air than a traditional perimeter high-flow filter. When combined with the smooth radius die-cast back plate, this open filter can feed a large displacement engine with an unobstructed flow of clean air. While sized to fit behind Original Equipment or accessory center-bolt air cleaner covers, the deep open-face filter provides maximum air-flow and style when paired with a matching open-face air cleaner trim option. Kit includes the gloss-black finished die-cast back plate with laser-engraved Screaming Eagle logo, an open-face washable oiled-cotton filter element, and all required installation gaskets and hardware. Optional Rain Sock P/N 29400363 is available to protect the exposed element in inclement weather. 50-State U.S. EPA compliant (except FLSB). **Screamin' Eagle performance upgrades for FLSB are 49-state U.S. EPA approved. Pending approval for use in California.**

29400357 Extreme Open-Face Filter. **\$204.95**
Fits '18-later Softail® and '17-later Touring and Trike models. Not compatible with air cleaner cover on CVO™ Touring models. All models require ECM calibration with Screamin' Eagle Pro Street Tuner for proper installation.

B. SCREAMIN' EAGLE ROUND HIGH-FLOW AIR CLEANER – CENTER BOLT

The Screamin' Eagle High-Flow Air Cleaner Kit provides increased airflow to boost the power of your Milwaukee-Eight® engine equipped model. The one-piece cast back plate is system-matched to the throttle body to deliver a smooth uninterrupted flow, and shaped to permit air to enter around the entire perimeter of the air cleaner housing. The back plate is topped with a washable perimeter-flow oiled-cotton filter element that captures debris while passing significantly more air than the stock filter. This High Flow Air Cleaner can be dressed with most round Original Equipment or accessory center-bolt air cleaner covers. Or choose to flaunt your performance gains with the open element look, and finish it off with custom Air Cleaner Trim from one of the Harley-Davidson® decorative collections. This kit includes air cleaner element, gloss black back plate with laser-engraved Screaming Eagle logo, breather and all required hardware. Optional Rain Sock P/N 29400363 is available to protect the exposed element in inclement weather. 50-State U.S. EPA compliant.

29400355 **\$189.95**
Fits '18-later Softail and '17-later Touring and Trike models. '17-later Touring and Trike models require separate purchase of accessory round air cleaner cover or trim. Not compatible with air cleaner cover on CVO Touring models. All models require ECM calibration with Screamin' Eagle Pro Street Tuner for proper installation.

C. SCREAMIN' EAGLE ROUND HIGH-FLOW AIR CLEANER – PERIMETER BOLT

Feed your engine more air while maintaining the fresh-from-the-factory look. Designed to accept the Original Equipment Softail perimeter-bolt air cleaner cover, this Screamin' Eagle High-Flow Air Cleaner Kit allows free breathing and unobstructed airflow to your Milwaukee-Eight engine. The die-cast back plate is sized to permit airflow around the entire perimeter of the air cleaner. Your engine gets more air, and you feel more power throughout the rev range. The back plate features 5 threaded lugs that accept the perimeter-bolt air cleaner cover, and a chamfered throat that allows smooth flow into the throttle body. The kit includes the gloss-black finished die-cast back plate, a perimeter-flow washable oiled-cotton filter element, all required installation gaskets and hardware and a laser-engraved Screamin' Eagle logo to finish the look. Optional Rain Sock P/N 29400363 is available to protect the exposed element in inclement weather. 50-State U.S. EPA compliant.

29400356 **\$189.95**
Fits '18-later FLFB, FLFBS, FLSB, FXBB, FXBR, FXBRS, FXDRS, FXFB and FXFBS models with Original Equipment perimeter-bolt air cleaner cover. Not recommended for use with center-bolt air cleaner covers or trim. All models require ECM calibration with Screamin' Eagle Pro Street Tuner for proper installation.

Street legal and/or street compliant statements refer to product meeting 50-State emissions and noise standards in the United States.

The street legal and/or street compliant statements may not apply to markets outside of the United States.

Notice: The prices appearing in this catalog are the manufacturer's suggested retail prices. Actual retail prices may vary.



AIR CLEANER FILTER ELEMENT COMPARISON



A. SCREAMIN' EAGLE ROUND EXTREME-FLOW AIR CLEANER – CENTER BOLT



B. SCREAMIN' EAGLE ROUND HIGH-FLOW AIR CLEANER – CENTER BOLT

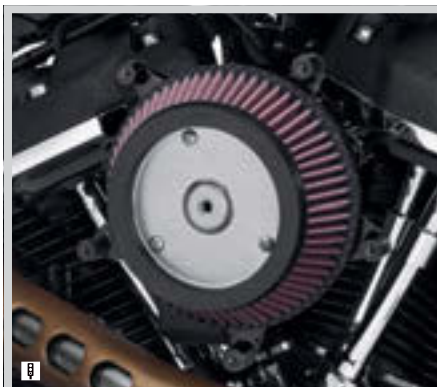

C. SCREAMIN' EAGLE ROUND HIGH-FLOW AIR CLEANER – PERIMETER BOLT



SCREAMIN' EAGLE® 447

Milwaukee-Eight® Air Cleaner Covers



D. SCREAMIN' EAGLE ROUND AIR CLEANER COVER – RATCHET



E. SCREAMIN' EAGLE ROUND AIR CLEANER COVER – CALIBRE

D. SCREAMIN' EAGLE® ROUND AIR CLEANER COVER – RATCHET

The Ratchet Air Cleaner Cover trims the face of the Screamin' Eagle® Round Air Cleaner filter in style. Ideal for use with Extreme open face filters, the forged aluminum cover wraps the leading edge of the filter element, covering the rubber gasket without restricting the airflow. The Ratchet Cover is finished in rich black, and features a center bar with Screamin' Eagle script and a lugged outer ring. The kit includes a black filler plate to cover the unfinished face of standard High Flow filter for a clean blacked-out appearance.

61300845 **\$164.95**

Fits '18-later Softail® and '17-later Touring and Trike models equipped with Screamin' Eagle round High Flow Air Cleaner.

E. SCREAMIN' EAGLE ROUND AIR CLEANER COVER – CALIBRE

The unique open slot design of the Calibre Air Cleaner Cover maximizes style without compromising performance. Ideal for use with Extreme open face filters, the forged aluminum cover wraps the leading edge of the filter element, covering the rubber gasket without restricting the airflow. The gloss black Calibre Cover features 3 radiused slots cut into the face and a Screamin' Eagle logo prominently on display. The kit includes a black filler plate to cover the unfinished face of standard High Flow filter for a clean blacked-out appearance.

61300846 **\$149.95**

Fits '18-later Softail and '17-later Touring and Trike models equipped with Screamin' Eagle round High Flow Air Cleaner.



F. AIR CLEANER TRIM KITS – BRASS COLLECTION



F. AIR CLEANER TRIM KITS – DARK CUSTOM

F. AIR CLEANER TRIM KITS

The perfect blend of performance and style. Available in a wide variety of styles, this bolt-on Air Cleaner Trim is sized to cover the face of most Screamin' Eagle Round High-Flow Air Cleaners. You can continue the look of your custom collection while maximizing air flow to the engine. Model-specific rain socks are available to protect the open element during inclement weather.

Fits Evolution® 1340 models, '99-'08 Dyna®, '00-'15 Softail (except FLS, FLSS, FLSTSB, and FXS) and '99-'13 Touring and Trike models equipped with oval-shaped Original Equipment air cleaner cover. Also fits models equipped with Screamin' Eagle Round High-Flow Air Cleaner Kits with separate purchase of Rain Sock Kit P/N 28728-10 or Air Cleaner Trim Installation Kit P/N 12400158.

61400339 Brass Collection. **\$119.95**

61300057 Dark Custom Collection. **\$114.95**

27956-10 Number One Skull Collection. **\$49.95**

29400366 Willie G Skull – Black. **\$49.95**

29417-04 Willie G Skull – Chrome. **\$49.95**

61400323 Airflow Collection. **\$59.95**

29328-99 Live To Ride Collection – Gold. **\$49.95**



F. AIR CLEANER TRIM KITS – #1 SKULL



F. AIR CLEANER TRIM KITS – WILLIE G SKULL – CHROME

Also available: (not shown)

SCREAMIN' EAGLE AIR CLEANER RAIN SOCK

Protect your exposed-element air cleaner during inclement weather. This mesh cover stretches over the filter to repel moisture that could damage the filter and be drawn into the engine. The breathable cover does not significantly reduce air flow to the engine.

29400363 For Round High-Flow Filter. **\$29.95**

Fits '18-later Softail and '17-later Touring and Trike models equipped with Screamin' Eagle High-Flow Air Cleaners with round perimeter flow air cleaner element.

29493-05A For Heavy Breather Filter. **\$24.95**

Fits models equipped with Screamin' Eagle Heavy Breather Air Cleaner Kits (except Compact Heavy Breather P/N 28716-10, Heavy Breather Elite P/N 29400173, 29400172 or 29400285, and Milwaukee-Eight® Heavy Breather P/N 29400263 or 29400264).



F. AIR CLEANER TRIM KITS – AIRFLOW



F. AIR CLEANER TRIM KITS – LIVE TO RIDE

Street legal and/or street compliant statements refer to product meeting 50-State emissions and noise standards in the United States.

The street legal and/or street compliant statements may not apply to markets outside of the United States.

Notice: The prices appearing in this catalog are the manufacturer's suggested retail prices. Actual retail prices may vary.

448 SCREAMIN' EAGLE®

Air Cleaner Covers

A. DARK CUSTOM™ LOGO COLLECTION – AIR CLEANER TRIM

The famous Harley-Davidson #1 logo with a sinister twist. Styled to complement chrome or blacked-out motorcycles, this rich black air cleaner trim features a machined Dark Custom #1 logo at its center. Formed from aluminum, this self-adhesive buckshot-hole cover fits perfectly into the recessed face of the Original Equipment Softail® perimeter-bolt air cleaner cover.

61300892 **\$49.95**
Fits '18-later FLFB, FLSB, FXBB, FXBR and FXFB models with Original Equipment perimeter bolt air cleaner cover.

B. AIR CLEANER TRIM – BAR & SHIELD

Styled to complement polished or blacked-out engines, this rich black bullet-hole air cleaner trim features a simple etched Bar & Shield logo at its center. Easy to install, this self-adhesive formed aluminum trim fits perfectly into the recessed face of the Softail models Original Equipment perimeter bolt air cleaner cover.

61300891 **\$49.95**
Fits '18-later FLFB, FLSB, FXBB, FXBR and FXFB models with Original Equipment perimeter bolt air cleaner cover.

C. AIR CLEANER TRIM – BRUSHED ALUMINUM

Show off your Milwaukee-Eight® engine's displacement with pride. Available for 107 and 114 cubic inch engines, this brushed aluminum and black trim is the perfect complement to chrome or black engine finishes. This easy to install self-adhesive formed aluminum trim fits perfectly into the recessed face of the Softail models Original Equipment perimeter bolt air cleaner cover.

Fits '18-later FLFB, FLSB, FXBB, FXBR and FXFB models with Original Equipment perimeter bolt air cleaner cover.

61300788 107 Logo. **\$44.95**
61300787 114 Logo. **\$44.95**



A. DARK CUSTOM LOGO COLLECTION – AIR CLEANER TRIM



B. AIR CLEANER TRIM – BAR & SHIELD



C. AIR CLEANER TRIM – BRUSHED ALUMINUM

Street legal and/or street compliant statements refer to product meeting 50-State emissions and noise standards in the United States.

The street legal and/or street compliant statements may not apply to markets outside of the United States.

Notice: The prices appearing in this catalog are the manufacturer's suggested retail prices. Actual retail prices may vary.

SCREAMIN' EAGLE® 449

Air Cleaner Covers



D. BOBBER-STYLE ROUND AIR CLEANER COVER – CHROME

D. BOBBER-STYLE ROUND AIR CLEANER COVER

Low-profile round air cleaner cover adds an attractive nostalgic look to any bike's profile. This cover can be accented with your choice of stylish air cleaner trim collections (sold separately) for a personalized look. The cover features a cut-away bottom design that exposes the filter element to maximize the airflow when installed with a Screamin' Eagle® High-Flow Air Cleaner Kit.

Fits '12-'16 XL1200V and '11-'15 FLS and FXS models with Original Equipment round air cleaner. Also fits models equipped with Screamin' Eagle Round High-Flow Air Cleaner Kits.

61300120	Chrome.	\$54.95
61300128	Gloss Black.	\$54.95

E. MILWAUKEE-EIGHT® ENGINE AIR CLEANER COVER – GLOSS BLACK

Complete the blacked-out look. This Gloss Black Air Cleaner Cover adds a sinister touch without changing the signature profile of your Milwaukee-Eight® engine.

61300828 **\$69.95**
Fits '17-later Touring (except CVO™) and Trike models with Original Equipment air cleaner or Screamin' Eagle Wedge High-Flow Air Cleaner.



D. BOBBER-STYLE ROUND AIR CLEANER COVER – GLOSS BLACK



E. MILWAUKEE-EIGHT ENGINE AIR CLEANER COVER – GLOSS BLACK

Street legal and/or street compliant statements refer to product meeting 50-State emissions and noise standards in the United States.

The street legal and/or street compliant statements may not apply to markets outside of the United States.

Notice: The prices appearing in this catalog are the manufacturer's suggested retail prices. Actual retail prices may vary.

450 SCREAMIN' EAGLE®

Milwaukee-Eight® Stage I Upgrade

A. SCREAMIN' EAGLE® STREET CANNON MUFFLERS – CHROME

Call attention to your ride without calling attention to your ride. Tuned to provide a deep base exhaust note and great rumble throughout the RPM range, these 3.5" Street Cannon mufflers deliver the famous Harley sound while preserving the peace with your neighbors. You get a nice bark when you get on the throttle, and a deep mellow tone when cruising at constant speed. The tuned baffles work with the internal high-flow catalyst to strike the perfect balance required to deliver performance that you can feel in your gut. The large 3.5" diameter Street Cannons provide free flow of exhaust gases with just the right amount of back pressure for a smooth-running ride. Mufflers include matching chrome end caps with subtle engraved Screamin' Eagle logo. Looking to black out your ride? Optional satin black wrap-around muffler shields and end caps are available to complete the look.

64900636 Short – Domestic. **\$549.95**

Fits '18-later FLDE, FLHC and FLHCS models. Includes chrome muffler end caps. Installation requires separate purchase of Muffler Clamps P/N 65900012 (Qty 2) and Exhaust Gaskets P/N 65900017 (Qty 2). All models require ECM calibration with Screamin' Eagle® Pro Street Tuner (sold separately). 50-State U.S. EPA compliant.

64900638 Short – ECE Certified. **\$674.95**

Designed for International markets that require ECE certified mufflers. Fits '18-later FLDE, FLHC and FLHCS models. Includes chrome muffler end caps. Installation requires separate purchase of Muffler Clamps P/N 65900012 (Qty 2) and Exhaust Gaskets P/N 65900017 (Qty 2).

64900690 Long – Domestic. **\$549.95**

Fits '18-later FLFB, FLFBS, FLFL, FXBB, FXBR, FXBRS and FXLR models. Includes chrome muffler end caps. Installation requires separate purchase of Muffler Clamps P/N 65900012 (Qty 2) and Exhaust Gaskets P/N 65900017 (Qty 2). All models require ECM calibration with Screamin' Eagle Pro Street Tuner (sold separately). 50-State U.S. EPA compliant.

64900691 Long – ECE Certified. **\$674.95**

Designed for International markets that require ECE certified mufflers. Fits '18-later FLFB, FLFBS, FLFL, FXBB, FXBR, FXBRS and FXLR models. Includes chrome muffler end caps. Installation requires separate purchase of Muffler Clamps P/N 65900012 (Qty 2) and Exhaust Gaskets P/N 65900017 (Qty 2).

B. MUFFLER END CAPS – 3.5" SATIN BLACK

These easy-to-install caps allow you to finish your Softail® 3.5" Screamin' Eagle Street Cannon mufflers your way. Sold in pairs these Satin Black end caps feature a subtle engraved Screamin' Eagle script for a clean look. Installation hardware included.

65100153 **\$109.95**

Fits '18-later Softail models equipped with Screamin' Eagle Street Cannon Mufflers P/N 64900636, 64900638, 64900690 or 64900691.



A. SCREAMIN' EAGLE STREET CANNON MUFFLERS – CHROME, SHORT (SHOWN ON SOFTAIL DELUXE MODEL)



A. SCREAMIN' EAGLE STREET CANNON MUFFLERS – CHROME, LONG (SHOWN ON FAT BOY MODEL)



A. STANDARD CHROME MUFFLER END CAPS (INCLUDED WITH STREET CANNON MUFFLERS)



B. SCREAMIN' EAGLE SATIN BLACK MUFFLER END CAPS

Street legal and/or street compliant statements refer to product meeting 50-State emissions and noise standards in the United States.

The street legal and/or street compliant statements may not apply to markets outside of the United States.

Notice: The prices appearing in this catalog are the manufacturer's suggested retail prices. Actual retail prices may vary.



**C. SATIN BLACK MUFFLER SHIELDS – SHORT
(SHOWN ON FLHC MODEL WITH SATIN BLACK EXHAUST SHIELDS)**



**C. SATIN BLACK MUFFLER SHIELDS – LONG
(SHOWN ON FAT BOY MODEL WITH SATIN BLACK EXHAUST SHIELDS)**



C. SCREAMIN' EAGLE MUFFLER SHIELDS – SATIN BLACK

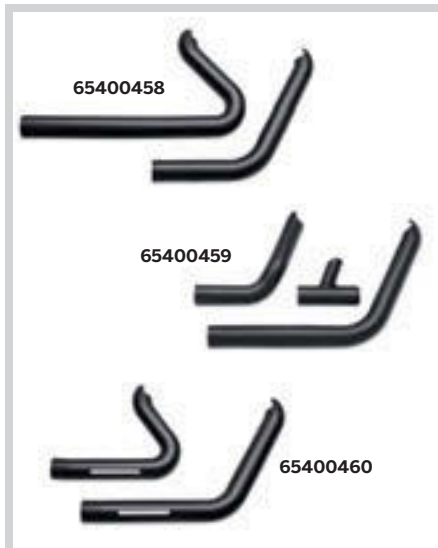

C. SATIN BLACK EXHAUST SHIELD KITS

SCREAMIN' EAGLE® 451

Milwaukee-Eight® Stage I Upgrade

C. SATIN BLACK MUFFLER SHIELDS

Complete the blacked out look. These rich satin-black shields wrap the chrome Street Cannon mufflers and complete the conversion to a sinister look. Styled to hug the lines of the mufflers, the blunt-cut shields are sized to expose the muffler end cap for a custom touch. Easy-to-install kit includes front and rear shields and black mounting clamps.

65400457 Short Shields. **\$129.95**
Fits '18-later FLDE, FLHC and FLHCS models equipped with Screamin' Eagle® Street Cannon Mufflers P/N 64900636 or 64900638.

65400461 Long Shields. **\$129.95**
Fits '18-later FLFB, FLFBS, FLFL, FXBB, FXBR, FXBRS and FXLR models equipped with Screamin' Eagle Street Cannon Mufflers P/N 64900690 or 64900691.

Shown with:

SATIN BLACK EXHAUST SHIELD KIT

Extend the custom look along the bike's entire profile. These formed steel exhaust shields are available in a unique satin black ceramic finish that complements black Screamin' Eagle Street Cannon Muffler Shields. This exhaust shield kit has survived stringent Harley-Davidson testing for durability and corrosion resistance. Manufactured to Original Equipment standards for exact fit, the easy-to-install kit includes front and rear head pipe shields.

65400458 **\$199.95**
Fits '18-later FLDE, FLHC and FLHCS models.

65400459 **\$199.95**
Fits '18-later FLFL and FXLR models.

65400460 **\$199.95**
Fits '18-later FLFB, FLFBS, FXBR and FXBRS models.

SCREAMIN' EAGLE

Street legal and/or street compliant statements refer to product meeting 50-State emissions and noise standards in the United States.

The street legal and/or street compliant statements may not apply to markets outside of the United States.

Notice: The prices appearing in this catalog are the manufacturer's suggested retail prices. Actual retail prices may vary.

452 SCREAMIN' EAGLE®

Milwaukee-Eight® Stage I Upgrade

A. SCREAMIN' EAGLE® STREET CANNON MUFFLERS – FAT BOB® MODELS

These 4.5" street compliant high-flow mufflers have been specifically tuned to deliver an aggressive exhaust note and improved performance. The straight-through perforated baffle reduces airflow restriction, and produces a rich exhaust note throughout the entire RPM range. You get a great performance, a powerful base rumble and a throaty tone while on the throttle, while maintaining a mellow note while cruising. Available in your choice of Brushed Satin Chrome or heat resistant Satin Black ceramic finish. Matching or contrasting end caps (sold separately) complete the custom look.

Fits '18-later FXFB and FXFBS models. Installation requires separate purchase of Muffler End Caps P/N 65100122 or 65100123. All models require ECM calibration with Screamin' Eagle® Pro Street Tuner (sold separately). 50 state U.S. EPA compliant.

64900640	Brushed Satin Chrome.	\$499.95
64900641	Satin Black.	\$499.95

Designed for International markets that require ECE certified mufflers. Fits '18-later FXFB and FXFBS models. Installation requires separate purchase of Muffler End Caps P/N 65100122 or 65100123.

64900642	Brushed Satin Chrome.	\$499.95
64900643	Satin Black.	\$499.95

B. MUFFLER END CAPS – 4.5" FAT BOB

These easy-to-install caps allow you to finish your 4.5" Fat Bob® Screamin' Eagle mufflers your way. Sold in pairs these Brushed Satin Chrome or Satin Black end caps feature a subtle engraved Screamin' Eagle script for a clean look. Installation hardware included.

Fits '18-later FXFB and FXFBS models equipped with Screamin' Eagle Street Cannon Mufflers P/N 64900640, 64900641, 64900642 and 64900643.

65100123	Brushed Satin Chrome.	\$119.95
65100122	Satin Black.	\$119.95



A. SCREAMIN' EAGLE STREET CANNON MUFFLERS – FAT BOB, BRUSHED SATIN CHROME



A. SCREAMIN' EAGLE STREET CANNON MUFFLERS – FAT BOB, SATIN BLACK



A. SCREAMIN' EAGLE STREET CANNON MUFFLERS – FAT BOB



B. MUFFLER END CAPS – 4.5" FAT BOB

Street legal and/or street compliant statements refer to product meeting 50-State emissions and noise standards in the United States.

The street legal and/or street compliant statements may not apply to markets outside of the United States.

Notice: The prices appearing in this catalog are the manufacturer's suggested retail prices. Actual retail prices may vary.



NEW

C. SCREAMIN' EAGLE STREET CANNON MUFFLERS – SPORT GLIDE MODELS, BLACK (SHOWN WITH BLACK MUFFLER SHIELD)

SCREAMIN' EAGLE® 453

Milwaukee-Eight® Stage I Upgrade

C. SCREAMIN' EAGLE® STREET CANNON MUFFLERS – SPORT GLIDE™ MODELS

Tuned to provide a deep base exhaust note and great rumble throughout the RPM range, this 4.5" Street Cannon muffler delivers the famous Harley sound while preserving the peace with your neighbors. You get a nice bark when you get on the throttle, and a deep mellow tone when cruising at constant speed. The tuned baffle works with the internal high flow catalyst to strike the perfect balance required to deliver performance that you can feel in your gut. The large 4.5" diameter Street Cannon provides free flow of exhaust gases with just the right amount of back pressure for a smooth-running ride and can be fitted with a wide variety of styled muffler end caps to provide the perfect finishing touch. Requires choice of chrome or satin black muffler shield with laser etched logo.

Fits '18-later FLSB models. Installation requires separate purchase of Muffler Shield, Muffler End Cap, Muffler Clamp P/N 65900007 (Qty 1) and Muffler Gasket P/N 65900040 (Qty 1). Requires ECM calibration with Screamin' Eagle® Pro Street Tuner (sold separately). **Screamin' Eagle performance upgrades for FLSB are 49-state U.S. EPA approved. Pending approval for use in California.**

64900752	Chrome.	\$424.95
64900754	Black.	\$479.95

Designed for International markets that require ECE certified mufflers. Fits '18-later FLSB models. Installation requires separate purchase of Muffler Shield, Muffler End Cap, Muffler Clamp P/N 65900007 (Qty 1) and Muffler Gasket P/N 65900040 (Qty 1).

64900756	Chrome, ECE	\$509.95
64900758	Black, ECE	\$519.95

Shown with:

MUFFLER SHIELD

Styled to hug the lines of the uniquely shaped stepped muffler design of the Screamin' Eagle Street Cannon for Sport Glide™. Offered in both chrome and satin black and feature a subtle engraved Screamin' Eagle script for a clean look.

Fits '18-later FLSB models equipped with Screamin' Eagle Street Cannon Mufflers P/Ns 64900752, 64900754, 64900756, 64900758.

65400466	Chrome.	\$64.95
65400468	Black.	\$74.95

D. MUFFLER END CAPS – 4.5"

Fits '18-later FLSB and '17-later Touring models equipped with 4.5" Screamin' Eagle Street Cannon Mufflers. Does not fit CVO™ Touring mufflers. Sold Individually.

1. 65100165	Slash Cut – Chrome.	\$54.95
2. 65100166	Slash Cut – Black.	\$54.95
3. 65100162	Defiance – Chrome.	\$99.95
4. 65100163	Defiance – Gloss Black.	\$99.95
5. 65100164	Defiance – Machine Cut.	\$104.95
6. 65100160	Two-Piece – Chrome.	\$84.95
7. 65100161	Two-Piece – Black.	\$84.95



NEW

C. SCREAMIN' EAGLE STREET CANNON MUFFLERS – SPORT GLIDE MODELS, CHROME (SHOWN WITH CHROME MUFFLER SHIELD)



NEW

D. MUFFLER END CAPS

SCREAMIN' EAGLE

Street legal and/or street compliant statements refer to product meeting 50-State emissions and noise standards in the United States.

The street legal and/or street compliant statements may not apply to markets outside of the United States.

Notice: The prices appearing in this catalog are the manufacturer's suggested retail prices. Actual retail prices may vary.

454 SCREAMIN' EAGLE®

Milwaukee-Eight® Stage I Upgrade

A. SCREAMIN' EAGLE® MUFFLER KIT – FXDR 114 MODELS

The Screamin' Eagle® Titanium Performance Slip-on Muffler features Full Titanium construction providing a 50% weight reduction over stock mufflers increasing performance and acceleration. Kit includes pre-installed carbon fiber end cap and carbon fiber muffler shield along with required hardware for installation.

64900749 DOM **\$924.95**

Fits '19-later FXDRS models. All models require ECM calibration with Screamin' Eagle Pro Street Tuner (sold separately). 50 state U.S. EPA compliant.

64900760 ECE **\$924.95**

Designed for international markets that required ECE certification. Fits '19-later FXDRS models.

NEW



A. SCREAMIN' EAGLE MUFFLER KIT – FXDR 114 MODELS

NEW



A. SCREAMIN' EAGLE MUFFLER KIT – FXDR 114 MODELS

Street legal and/or street compliant statements refer to product meeting 50-State emissions and noise standards in the United States.

The street legal and/or street compliant statements may not apply to markets outside of the United States.

Notice: The prices appearing in this catalog are the manufacturer's suggested retail prices. Actual retail prices may vary.



NEW

SCREAMIN' EAGLE® 455

Milwaukee-Eight® Stage I Upgrade

SATIN BLACK EXHAUST SHIELDS

Extend the custom look along the bike's entire profile. These formed steel exhaust shields are available in a unique satin black finish that complements black Screamin' Eagle® Street Cannon Muffler Shields. This exhaust kit has survived stringent Harley-Davidson testing for durability and corrosion resistance. Manufactured to Original Equipment standards for exact fit.

B. SATIN BLACK COLLECTOR SHIELD

65400480 **\$74.95**
Fits '18-later FLSB models.

C. SATIN BLACK COLLECTOR SHIELD

65400481 **\$99.95**
Fits '18-later FXFB and FXFBS models.

D. SATIN BLACK EXHAUST SHIELD KIT

65400472 **\$169.95**
Fits '18-later FLSB, FXFB, FXFBS and '19-later FXDRS models.

B. SATIN BLACK COLLECTOR SHIELD – SPORT GLIDE MODELS



NEW

C. SATIN BLACK COLLECTOR SHIELD – FAT BOB MODELS



NEW

D. SATIN BLACK EXHAUST SHIELD KIT

SCREAMIN' EAGLE

Street legal and/or street compliant statements refer to product meeting 50-State emissions and noise standards in the United States.

The street legal and/or street compliant statements may not apply to markets outside of the United States.

Notice: The prices appearing in this catalog are the manufacturer's suggested retail prices. Actual retail prices may vary.

456 SCREAMIN' EAGLE®

Milwaukee-Eight® Stage I Upgrade

A. SCREAMIN' EAGLE® STREET CANNON PERFORMANCE SLIP-ON MUFFLERS – 4.5"

Dialed in to enhance the performance of the Milwaukee-Eight® engine, these slip-on mufflers feature a large inlet for improved airflow. When teamed with a free-flowing air cleaner, these Street Cannon mufflers deliver horsepower and torque gains you can feel. The large 4.5" diameter mufflers are tuned to provide a rich exhaust note, a deep bass rumble, and great throaty sound when you roll on the throttle. But to strike a balance with your neighbors, the large internal volume and strategically designed baffles help maintain the peace at partial throttle. The large diameter body adds a muscular look to your ride, and the newly designed mounts keep the mufflers tucked in close to the bags for a clean profile. These Street Cannon mufflers feature a die-cast Screamin' Eagle® medallion on their flanks, and can be fitted with a wide variety of styled muffler end caps to provide the perfect finishing touch.

Fits '17-later Touring models. Does not fit Trike models. Installation requires separate purchase of Muffler Clamps P/N 65900012 and 65900015. Requires separate purchase of end caps. All models require ECM calibration with Screamin' Eagle Pro Street Tuner for proper installation. 50-State U.S. EPA compliant.

64900552A	Chrome.	\$449.95
64900553A	Satin Black.	\$499.95

Fits '17-later Touring models. Does not fit Trike models. Designed for International markets that require ECE certified mufflers. Includes matching Two-piece Muffler end caps. Installation requires separate purchase of Muffler Clamps P/N 65900012 and 65900015.

64900555A	Chrome – ECE Certified.	\$599.95
64900554A	Satin Black – ECE Certified.	\$699.95

B. SATIN BLACK EXHAUST SHIELD KIT

These formed steel exhaust shields feature a unique black coating that complements the finish of the Screamin' Eagle black slip-on mufflers. The rich black coating maintains its uniform black finish and has survived stringent Harley-Davidson testing for durability and corrosion resistance. Manufactured to Original Equipment standards for exacting fit, the easy-to-install kit includes front and rear head pipe shields.

65400285		\$249.95
-----------------	--	-----------------

Fits '17-later Touring and Trike models.



A. SCREAMIN' EAGLE STREET CANNON PERFORMANCE SLIP-ON MUFFLERS – 4.5" – CHROME (SHOWN WITH CHROME TWO-PIECE END CAPS)



A. SCREAMIN' EAGLE STREET CANNON PERFORMANCE SLIP-ON MUFFLERS – 4.5" – SATIN BLACK (SHOWN WITH SATIN BLACK TWO-PIECE END CAPS)



B. SATIN BLACK EXHAUST SHIELD KIT

Street legal and/or street compliant statements refer to product meeting 50-State emissions and noise standards in the United States.

The street legal and/or street compliant statements may not apply to markets outside of the United States.

Notice: The prices appearing in this catalog are the manufacturer's suggested retail prices. Actual retail prices may vary.

SCREAMIN' EAGLE® 457

Milwaukee-Eight® Stage I Upgrade



C. TWO-PIECE MUFFLER END CAP KIT – 4.5" – CHROME



C. TWO-PIECE MUFFLER END CAP KIT – 4.5"

Shaped to provide a complete finishing touch to the rear of your bike, these slash cut end caps feature a reverse cone rolled edge for a massive solid billet look. The reverse cone opening hugs the internal slotted flash suppressor-inspired barrel for a weapons-grade style.

Fits '17-later Touring models equipped with 4.5" Screamin' Eagle® Street Cannon mufflers. Does not fit CVO™ Touring mufflers.

65100078	Chrome.	\$149.95
65100076	Satin Black.	\$149.95



C. TWO-PIECE MUFFLER END CAP KIT – 4.5" – SATIN BLACK



D. DEFIANCE COLLECTION MUFFLER END CAP KIT – 4.5"

Show your complete disregard for the rules. Anything but traditional, these forged aluminum muffler end caps add a new rebellious look to your bike. The deep longitudinal lines add visual length to the bike's profile, and the big, beefy look is the perfect complement to the Street Cannon 4.5" mufflers. Available in your choice of chrome, machine cut anodized black or full black finishes, this kit includes two end caps and all required mounting hardware.

Fits '17-later Touring models equipped with 4.5" Screamin' Eagle Street Cannon mufflers. Does not fit CVO Touring mufflers.

65100095	Chrome.	\$184.95
65100096	Gloss Black Anodized.	\$184.95
65100097	Gloss Black with Machined Highlights.	\$199.95

E. BLUNT SLASH UP/DOWN/OUT MUFFLER END CAP KIT – 4.5"

These easy-to-install slash cut end caps allow you to finish your 4.5" Screamin' Eagle Street Cannon mufflers your way. Sold in pairs. Installation hardware included.

Fits '17-later Touring models equipped with 4.5" Screamin' Eagle Street Cannon mufflers. Does not fit CVO Touring mufflers.

65100085	Chrome.	\$109.95
65100084	Satin Black.	\$109.95



D. DEFIANCE COLLECTION MUFFLER END CAP KIT – 4.5" – CHROME



D. DEFIANCE COLLECTION MUFFLER END CAP KIT – 4.5" – GLOSS BLACK ANODIZED



D. DEFIANCE COLLECTION MUFFLER END CAP KIT – 4.5" – GLOSS BLACK WITH HIGHLIGHTS



D. DEFIANCE COLLECTION MUFFLER END CAPS



E. BLUNT SLASH UP/DOWN/OUT MUFFLER END CAP KIT – 4.5" – CHROME

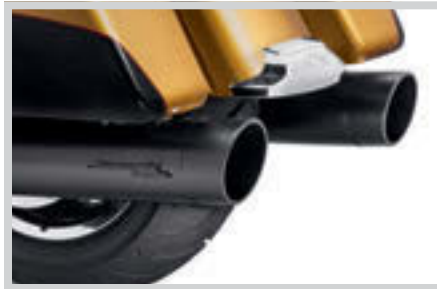

E. BLUNT SLASH UP/DOWN/OUT MUFFLER END CAP KIT – 4.5" – SATIN BLACK

SCREAMIN' EAGLE

Street legal and/or street compliant statements refer to product meeting 50-State emissions and noise standards in the United States.

The street legal and/or street compliant statements may not apply to markets outside of the United States.

Notice: The prices appearing in this catalog are the manufacturer's suggested retail prices. Actual retail prices may vary.

458 SCREAMIN' EAGLE®

Milwaukee-Eight® Stage I Upgrade

A. SCREAMIN' EAGLE® HIGH-FLOW EXHAUST SYSTEM WITH STREET CANNON MUFFLERS

The Screamin' Eagle® High-Flow Exhaust system provides bolt-on performance by reducing the catalyst restrictions and improving exhaust flow. This exhaust system is optimized for use with Screamin' Eagle Stage Kit-equipped Milwaukee-Eight® engines. The complete exhaust system starts with race-shop constructed oversized mandrel-bent and hand TIG-welded stainless steel head pipes, and flows through a unique crossover to improve the flow of spent cylinder gasses. The large inlet 4.5" Street Cannon mufflers feature baffles that are optimized for aggressive performance and sound under acceleration, and deliver a rich mellow note. The combination of tuned-flow headers and Street Cannon mufflers with relocated catalyst maximizes horsepower, maintains solid midrange torque and manages heat. The proof is in the horsepower and torque numbers. Dial the system to your motorcycle by using the Screamin' Eagle Pro Street Tuner to tune your ECM specifically to match your performance upgrades. The complete system includes exhaust headers pre-tapped for standard or Screamin' Eagle wide-band O2 sensors, large 4.5" diameter Street Cannon mufflers, and matching exhaust heat shields. Complete the look with your choice of custom muffler end caps (sold separately). 50-State U.S. EPA compliant.

Fits '17-later Touring models. Does not fit Trike models. Separate purchase of Screamin' Eagle 4.5" end caps required. All models require ECM calibration with Screamin' Eagle Pro Street Tuner for proper installation. See Dealer for details.

64800059	Chrome.	\$1,400.00
64800062	Satin Black.	\$1,500.00

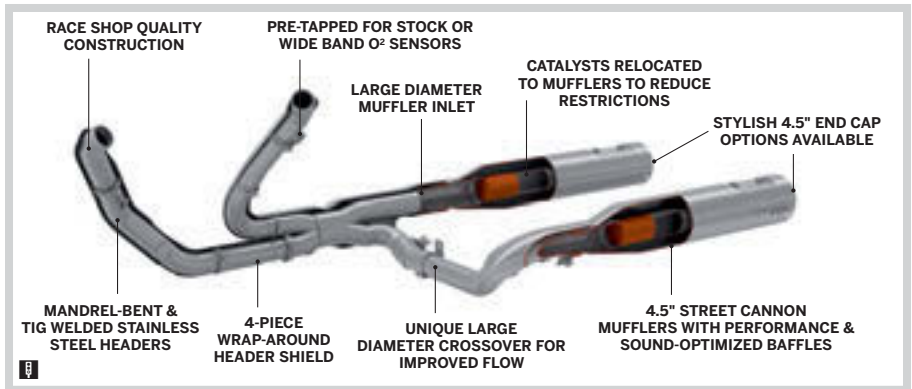

A. SCREAMIN' EAGLE HIGH-FLOW EXHAUST SYSTEM WITH STREET CANNON MUFFLERS



A. SCREAMIN' EAGLE HIGH-FLOW EXHAUST SYSTEM WITH STREET CANNON MUFFLERS – CHROME (SHOWN WITH TWO-PIECE MUFFLER END CAPS)



A. SCREAMIN' EAGLE HIGH-FLOW EXHAUST SYSTEM WITH STREET CANNON MUFFLERS – SATIN BLACK (SHOWN WITH TWO-PIECE MUFFLER END CAPS)



A. HIGH-FLOW EXHAUST – CHROME



A. HIGH-FLOW EXHAUST – SATIN BLACK

Street legal and/or street compliant statements refer to product meeting 50-State emissions and noise standards in the United States.

The street legal and/or street compliant statements may not apply to markets outside of the United States.

Notice: The prices appearing in this catalog are the manufacturer's suggested retail prices. Actual retail prices may vary.

SCREAMIN' EAGLE® 459

Milwaukee-Eight® Stage I Upgrade



B. SCREAMIN' EAGLE STREET CANNON PERFORMANCE SLIP-ON MUFFLERS (SHOWN WITH SLASH UP/DOWN/OUT END CAPS)

B. SCREAMIN' EAGLE® STREET CANNON PERFORMANCE SLIP-ON MUFFLERS

Cue the orchestra. We tuned these mufflers to provide an exhaust note with some extra deep bass. You get the rumble you want and enhance that famous Harley sound, while preserving the peace with your neighbors. The tuned baffles work with the large internal volume to strike the perfect balance required to deliver performance that you can feel in your gut. The large 4.0" diameter Street Cannons provide free flow of exhaust gases with just the right amount of back pressure for a smooth-running ride. The die-cast Screamin' Eagle® medallion adds a rich touch to your bike's profile and a large selection of end cap designs are available (sold separately) to provide the perfect finishing touch. 50-State U.S. EPA compliant.

Fits '09-'16 Touring and '09-later Trike models (except CVO™ models and '10 FLHX and FLTRX models). Installation requires separate purchase of 4" end caps and Muffler Clamps P/N 65296-95A (Qty 2). All models require ECM calibration for proper installation. '17-later models require recalibration with Screamin' Eagle Pro Street Tuner (sold separately).

64900186B	Chrome.	\$424.95
64900187B	Jet Black.	\$474.95

C. MUFFLER END CAPS – 4"

These End Cap Kits allow you to personalize your Screamin' Eagle Street Performance Touring Mufflers. Available in your choice of styles, these easy-to-install caps are dressed with the same finish as the mufflers and exhaust shields for a consistent look front to back. Sold in pairs, the kit includes all required mounting hardware.

Fits '09-'16 Touring and '09-later Trike models equipped with Screamin' Eagle Street Cannon Touring 4" End Cap Mufflers. Does not fit 4" CVO Touring mufflers.

65100062	Short Slash.	\$89.95
65100016	Revolver.	\$99.95
65100015	Piston.	\$99.95
65100019	Slash Up/Down/Out.	\$99.95
65100018	Billet Tapered Slash.	\$149.95
65100017	Fishtail.	\$149.95
65100028	Satin Black Anodized.	\$149.95
80611-09	Blunt Revolver.	\$129.95



C. MUFFLER END CAPS – 4"

SCREAMIN' EAGLE

Street legal and/or street compliant statements refer to product meeting 50-State emissions and noise standards in the United States.

The street legal and/or street compliant statements may not apply to markets outside of the United States.

Notice: The prices appearing in this catalog are the manufacturer's suggested retail prices. Actual retail prices may vary.

THE BASICS

- Choose a **TORQUE CAM** or **POWER CAM** based on riding style
- A performance cam increases both the lift in the valve train (pushing the valve open further) and the duration of the valve opening (how long the valve stays open)

When installed by an authorized Harley-Davidson® Dealer within 60-days of the vehicle purchase, compliant kits do not impact the vehicle's limited warranty.

THE PERFORMANCE

TORQUE KIT

- The rider will feel up to a 15% increase in performance in the low- to mid- RPM range
- Experience crisp throttle response and acceleration that can be felt at slower speeds, perfect for passing slow moving vehicles without downshifting

POWER KIT

- The rider will feel up to a 25% increase in performance in the mid- to upper- RPM range
- Experience an adrenaline-pumping burst of speed while heading towards the red line



TORQUE



POWER



A. SCREAMIN' EAGLE® MILWAUKEE-EIGHT® STAGE II – TORQUE KIT (CHROME COVERS SHOWN)



B. SCREAMIN' EAGLE MILWAUKEE-EIGHT STAGE II – POWER KIT (GLOSS BLACK COVERS SHOWN)

A. SCREAMIN' EAGLE® MILWAUKEE-EIGHT® STAGE II – TORQUE KIT



This kit was developed for the budget minded rider that wants to experience crisp throttle response and acceleration they can feel at slower speeds. The 5% increase in torque can be felt immediately off the line and continues to build by up to a 14% increase @ 4500 RPM – the ideal power band for passing slow moving vehicles.

SE8-447 Cam

- Delivers enhanced torque and horsepower in the low to mid RPM range
- Produces passing power without a downshift or high revs
- Minimally invasive only requiring opening of the cam chest
- Retains Original Equipment Factory Warranty
- 50-State U.S. EPA compliant

Fit's '18-later Softail® and '17-later Touring models. Does not fit Trike models. Not intended for use on '18-later CVO™ Touring models. Requires separate purchase of Cam Drive Retention Kit P/N 25566-06. Installation may require Cam Spacer Kit P/N 25928-06. All models require ECM calibration with Screamin' Eagle® Pro Street Tuner for proper installation. See Dealer for details. **Pending Regulatory approval for '19-later models. Refer to the product information at www.H-D.com/shop for status. Screamin' Eagle performance upgrades for FLSB are 49-state U.S. EPA approved and is pending approval for use in California.**

92500047	Chrome Covers.	\$399.95
92500074	Gloss Black Covers.	\$429.95

B. SCREAMIN' EAGLE MILWAUKEE-EIGHT STAGE II – POWER KIT



This kit was developed for the budget minded rider that wants to experience that adrenaline-pumping burst of speed while heading toward the red line. The additional power starts to build @ 3000 RPM and continues to build by up to 24% at redline. Riding the bike aggressively will require downshifting to lower gears to keep the engine operating in the higher RPM range.

SE8-462 Cam

- Ideal for riders looking for excitement and are willing to ride in the upper RPM range
- Produces greater acceleration in the mid and upper RPM range
- Minimally invasive only requiring opening of the cam chest
- Retains Original Equipment Factory Warranty
- 50-State U.S. EPA compliant

Fit's '18-later Softail and '17-later Touring models. Does not fit Trike models. Requires separate purchase of Cam Drive Retention Kit P/N 25566-06. Installation may require Cam Spacer Kit P/N 25928-06. All models require ECM calibration with Screamin' Eagle Pro Street Tuner for proper installation. See Dealer for details. **Pending Regulatory approval for '19-later models. Refer to the product information at www.H-D.com/shop for status. Screamin' Eagle performance upgrades for FLSB are 49-state U.S. EPA approved and is pending approval for use in California.**

92500058	Chrome Covers.	\$399.95
92500075	Gloss Black Covers.	\$429.95

Street legal and/or street compliant statements refer to product meeting 50-State emissions and noise standards in the United States.

The street legal and/or street compliant statements may not apply to markets outside of the United States.

Notice: The prices appearing in this catalog are the manufacturer's suggested retail prices. Actual retail prices may vary.

SCREAMIN' EAGLE® 461

Milwaukee-Eight® Cams

Description	Part Number	Lift @ Valve Intake/Exhaust	Duration @ .050" Intake/Exhaust	Timing @ .050" Lift Open/Closed	TDC Lift @ Valve Intake/Exhaust
Stock	25400190	.350"/.374"	174°/199°	Intake: 7° ATDC/1° ABDC Exhaust: 33° BBDC/14° BTDC	.057"/.048"
CVO™	25400273	.432"/.445"	188°/212°	Intake: 11° ATDC/19° ABDC Exhaust: 47° BBDC/15° BTDC	.044"/.044"
SE8-447 TORQUE	25400199	.447"/.462"	197°/217°	Intake: 0° ATDC/17° ABDC Exhaust: 42° BBDC/5° BTDC	.080"/.064"
SE8-462 POWER	25400200	.462"/.463"	197°/235°	Intake: 7° ATDC/24° ABDC Exhaust: 53° BBDC/2° BTDC	.057"/.086"
SE8-498 POWER Included in Stage III Kit	25400202	.498"/.491"	209°/247°	Intake: 4° ATDC/33° ABDC Exhaust: 60° BBDC/7° BTDC	.065"/.103"
SE8-515 POWER Included in Stage IV Kit	25400201	Front Cylinder .515"/.513"	Front Cylinder 227°/249°	Front Cylinder Intake: 2° BTDC/45° ABDC Exhaust: 62° BBDC/7° ATDC	Front Cylinder .056"/.066"
		Rear Cylinder .516"/.515"	Rear Cylinder 219°/242°	Rear Cylinder Intake: 6° ATDC/45° ABDC Exhaust: 61.5° BBDC/.5° ATDC	Rear Cylinder .036"/.052"

Theoretical, based on rocker arm ratio of 1.65. Valve train components, operation temperature and tolerance stack-up will affect actual lifts.

C. SCREAMIN' EAGLE PERFORMANCE CAM SPECS

C. MILWAUKEE-EIGHT® PERFORMANCE CAMS

Screamin' Eagle performance upgrades for FLSB are 49-state U.S. EPA approved. Pending approval for use in California.

Screamin' Eagle® SE8-447 Cam – Torque

- Enhanced torque in the low to mid RPM band
- Ideal for a fully-loaded bike
- Increased horsepower in the mid RPM range
- Responds well to roll-on throttle application
- Crisp throttle response and acceleration at lower speeds
- Can be used with stock valve springs

Pending Regulatory approval for '19-later models. Refer to the product information at www.H-D.com/shop for status.

25400199 \$199.95

Screamin' Eagle SE8-462 Cam – Power

- Improved power in mid and upper RPM band
- Ideal for a fully-loaded bike
- Thrilling acceleration and crisp throttle response
- Ideal for rider who likes to downshift and twist the throttle
- Responds well to aggressive throttle application
- Can be used with stock valve springs

Pending Regulatory approval for '19-later models. Refer to the product information at www.H-D.com/shop for status.

25400200 \$199.95

Screamin' Eagle SE8-498 Cam – Power

Replacement cam for models equipped with Screamin' Eagle® Milwaukee-Eight® Stage III Kits.

- Improved acceleration on the straightaway
- Ideal for lighter bike with bigger displacement
- Exhilarating acceleration at high engine speeds.
- Responds well to a healthy twist of the throttle
- High-lift profile for complete filling of cylinders
- Requires Performance Valve Springs P/N 18100080

25400202 \$199.95

Screamin' Eagle SE8-515 Cam

Replacement cam for models equipped with Screamin' Eagle Milwaukee-Eight Stage IV Kits.

- Hard acceleration off the line
- Improved mid-range and high RPM horsepower
- Stump-pulling torque throughout the RPM band
- Significant increase in rear wheel torque and power
- High lift and long duration for complete cylinder filling
- Requires Performance Valve Springs P/N 18100080

25400201 \$199.95

Milwaukee-Eight® 107 Stock vs. 107 Stage II*

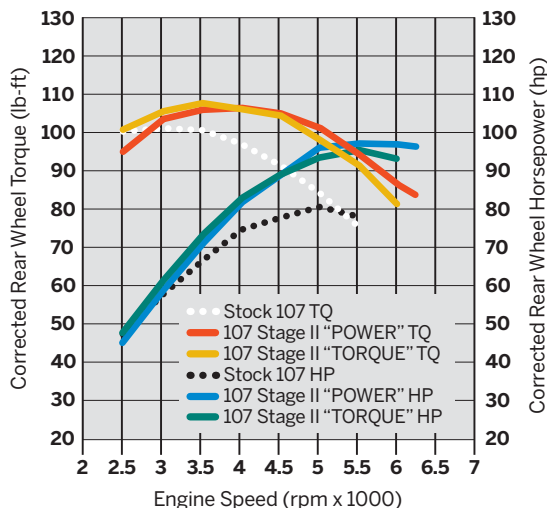

*FLHX 107 Stage II "POWER" with Ventilator A/C & Street Cannon Mufflers
*FLHX 107 Stage II "TORQUE" with Heavy Breather A/C & Street Cannon Mufflers

Milwaukee-Eight 114 Stock vs 114 Stage II**

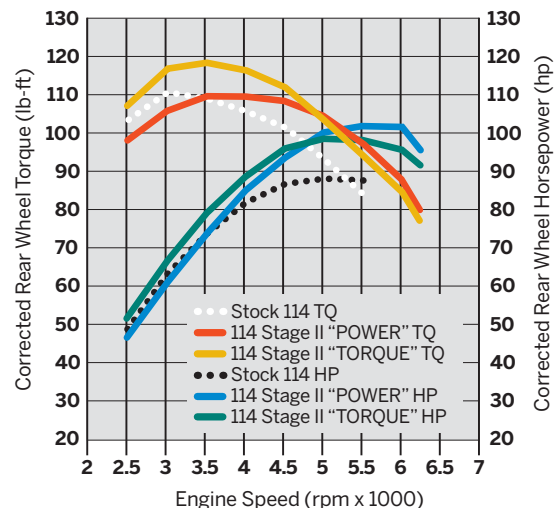

**FLHXSE 114 Stage II "POWER" with Ventilator A/C & Street Cannon Mufflers
**FLHXSE 114 Stage II "TORQUE" with Heavy Breather A/C & Street Cannon Mufflers

Street legal and/or street compliant statements refer to product meeting 50-State emissions and noise standards in the United States.

The street legal and/or street compliant statements may not apply to markets outside of the United States.

Notice: The prices appearing in this catalog are the manufacturer's suggested retail prices. Actual retail prices may vary.

462 SCREAMIN' EAGLE®

Milwaukee-Eight® Stage II Upgrade

A. SCREAMIN' EAGLE® PREMIUM TAPERED QUICK-INSTALL ADJUSTABLE PUSHRODS

These premium pushrods are tapered for enhanced clearance at the cylinder head, allowing the use of higher lift cams. The one-piece chrome moly tube adds rigidity and durability and the threaded adjustment feature provides easy cam installation without removing the cylinder heads or rocker boxes. To simplify adjustment, the tube features six flats, with one flat marked with a large dot for tracking the adjustment. The threaded rod features 4 flats to reduce wrench swing. Kit includes 4 pushrods and required pushrod tube covers.

Fits '18-later Softail® and '17-later Touring and Trike models.

17900073	With Black Covers.	\$249.95
17900058	With Chrome Covers.	\$199.95

B. SCREAMIN' EAGLE PERFORMANCE VALVE SPRING KIT

These performance beehive-shaped valve springs provide increased stiffness and strength in a compact design. Designed to support the installation of higher lift cams, these performance springs help maintain the stability of the valve train in high RPM conditions. Complete kit includes 8 springs, upper collars and keepers and lower collars with integral valve seals. Recommended for use with cam lifts greater than .470".

18100080 **\$269.95**
Fits '18-later Softail and '17-later Touring and Trike models.

NEW



A. SCREAMIN' EAGLE PREMIUM TAPERED QUICK-INSTALL ADJUSTABLE PUSHRODS – MILWAUKEE-EIGHT POWERTRAIN – BLACK COVERS



A. SCREAMIN' EAGLE PREMIUM TAPERED QUICK-INSTALL ADJUSTABLE PUSHRODS – MILWAUKEE-EIGHT POWERTRAIN – CHROME COVERS



B. SCREAMIN' EAGLE PERFORMANCE VALVE SPRING KIT – MILWAUKEE-EIGHT POWERTRAIN

Street legal and/or street compliant statements refer to product meeting 50-State emissions and noise standards in the United States.

The street legal and/or street compliant statements may not apply to markets outside of the United States.

Notice: The prices appearing in this catalog are the manufacturer's suggested retail prices. Actual retail prices may vary.

THE BASICS

- An increase in engine displacement allows the engine to swallow more air and fuel, a higher compression piston squeezes the air and fuel into a more volatile mixture and when combined, generates more power when ignited
- Displacement increases are accomplished with larger cylinders, matching pistons, and the proper cam upgrade

THE PERFORMANCE

- Riders will experience a performance increase throughout the entire RPM range, with up to a 35% increase in the mid- to upper- RPM range
- Produces instant passing power without downshifting
- Delivers excellent stoplight to freeway speed and on-ramp acceleration

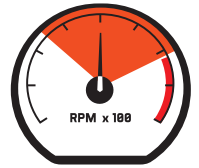

When installed by an authorized Harley-Davidson® Dealer within 60-days of the vehicle purchase, compliant kits do not impact the vehicle's limited warranty.

C. SCREAMIN' EAGLE® MILWAUKEE-EIGHT® ENGINE STAGE III KIT

This kit was developed for the rider looking for a solid seat of the pants increase you can feel – every time you roll on the throttle. The increase in displacement and the bump in compression deliver a significant increase in torque and power over stock while restoring the sensation of riding solo when taking that long trip with a passenger and luggage. The Stage III 107 to 114 upgrade delivers up to 39% more power, and the 114 to 117 upgrade increases power by up to 24% when compared to the Original Equipment engine configurations. The increased compression and cam upgrade will also deliver 17% improvement over a stock CVO117 configuration.

- Delivers increased throttle response throughout the entire RPM range
- Produces flexible roll-on passing power without a required downshift
- Delivers excellent stop-light to freeway speed on-ramp acceleration
- Retains Original Equipment Factory Warranty
- 50-State U.S. EPA compliant

- Kits include the following Screamin' Eagle® components:
- Screamin' Eagle 4.075" Bolt-On Cylinders
 - Forged 11:1 High Compression Aluminum Coated Pistons
 - High performance Piston Rings
 - SE8-498 Cam
 - Screamin' Eagle Performance Valve Springs
 - Screamin' Eagle High Performance Tappets
 - Multi-layer coated Head Gaskets
 - Cylinder Base and Cam Cover Gaskets
 - Screamin' Eagle Cam Bearing Upgrade
 - High Capacity Clutch Springs (1200N)
 - Most necessary gaskets and seals

Pending Regulatory approval for '19-later models. Refer to the product information at www.H-D.com/shop for status. Screamin' Eagle performance upgrades for FLSB are 49-state U.S. EPA approved and is pending approval for use in California.



Stage III – 107CI to 114CI

Fits '18-later Softail® and '17-later Touring models equipped with 107CI Milwaukee-Eight® engine. Does not fit Trike models. Requires separate purchase of Cam Drive Retention Kit P/N 25566-06. Installation may require Cam Spacer Kit P/N 25928-06. All models require ECM calibration with Screamin' Eagle Pro Street Tuner for proper installation.

92500056	Black Highlighted.	\$1,699.95
92500070	Black Non-Highlighted	\$1,699.95

Stage III – 114CI to 117CI

Fits '18-later Softail and '17-later Touring models equipped with 114CI Milwaukee-Eight engine. Does not fit Trike models. Requires separate purchase of Cam Drive Retention Kit P/N 25566-06. Installation may require Cam Spacer Kit P/N 25928-06. All models require ECM calibration with Screamin' Eagle Pro Street Tuner for proper installation.

92500072	Black Highlighted.	\$1,699.95
92500071	Black Non-Highlighted.	\$1,699.95

Stage III – 114CI to 117CI or 117CI to 117CI

Fit's '18-later Softail and '17-later CVO™ Touring models equipped with 114CI or 117CI Milwaukee-Eight engine. Requires separate purchase of Cam Drive Retention Kit P/N 25566-06. Installation may require Cam Spacer Kit P/N 25928-06. All models require ECM calibration with Screamin' Eagle Pro Street Tuner for proper installation.

92500057	Black Granite.	\$1,699.95
-----------------	----------------	-------------------

Street legal and/or street compliant statements refer to product meeting 50-State emissions and noise standards in the United States.

The street legal and/or street compliant statements may not apply to markets outside of the United States.

Notice: The prices appearing in this catalog are the manufacturer's suggested retail prices. Actual retail prices may vary.

464 SCREAMIN' EAGLE®

Milwaukee-Eight® Stage IV Upgrade

STAGE IV

THE BASICS

- Highest level performance upgrade available to provide a maximum increase in displacement, compression and flow
- Higher-flowing CNC ported cylinder heads and larger bore throttle body increase the velocity and feed large volumes of air and fuel into the engine, which maximizes power on a larger displacement engine
- Combines ported cylinder heads and larger throttle body in combination with cylinders, matching pistons and proper cam

A. SCREAMIN' EAGLE® MILWAUKEE-EIGHT® ENGINE STAGE IV KIT

This Stage IV Kit was developed to deliver maximum horsepower from the Milwaukee-Eight® engine – all the way to the redline. The system-matched combination of larger displacement cylinders, free flowing CNC-Ported cylinder heads and a cam with the highest available valve lift are the starting point to building the perfect engine for the performance junkie. The addition of the large 64mm bore throttle body and high-flow injectors provides great acceleration from first gear through sixth and exceptional response at the twist of the throttle. Designed for a high level of flexibility, this package is ideal for riders who want stump pulling torque throughout the rpm range and also crave plenty of arm-pulling acceleration when you whack the throttle. The Stage IV 107 to 114 upgrade delivers up to 52% more power, and the 114 to 117 upgrade increases power by up to 40% when compared to the Original Equipment engine configurations.

- Delivers increased response throughout the entire RPM range
- Provides thrilling acceleration when twisting the throttle
- Maintains flat torque curve from cruising RPM to redline
- Can be installed without removing the engine from the chassis
- Retains Original Equipment Factory Warranty
- 50-State U.S. EPA compliant
- Pending Regulatory approval for '19-later models. Refer to the product information at www.H-D.com/shop for status. Screamin' Eagle performance upgrades for FLSB are 49-state U.S. EPA approved and is pending approval for use in California.

Kits includes:

- Screamin' Eagle® CNC Ported Cylinder Heads with Performance Valve Springs
- Screamin' Eagle 64mm Throttle Body
- Screamin' Eagle High Flow Injectors (5.5g/s)
- Screamin' Eagle 4.075" Bolt-On Cylinders
- Forged 11:1 High Compression Aluminum Coated Pistons
- High Performance Piston Rings
- SE8-515 Cam
- Screamin' Eagle Cam Bearing Upgrade
- Screamin' Eagle High Performance Tappets
- Multi-layer Coated Head Gaskets
- High Capacity Clutch Springs (1200N)
- High Capacity Clutch Disks (107CI to 114CI Kits only)
- Most necessary gaskets and seals

Stage IV – 107CI to 114CI – Air/Oil-Cooled

92500062 Black Highlighted. **\$2,699.95**
Fits '18-later Softail® and '17-later Touring models equipped with air/oil-cooled 107CI Milwaukee-Eight engine. Does not fit Trike models. Requires separate purchase of Cam Drive Retention Kit P/N 25566-06. Installation may require Cam Spacer Kit P/N 25928-06. All models require ECM calibration with Screamin' Eagle® Pro Street Tuner for proper installation.

Stage IV – 114CI to 117CI – Air/Oil-Cooled

92500073 Black Highlighted. **\$2,699.95**
Fits '18-later Softail® and '17-later Touring models equipped with air/oil-cooled 114CI Milwaukee-Eight engine. Does not fit Trike models. Requires separate purchase of Cam Drive Retention Kit P/N 25566-06. Installation may require Cam Spacer Kit P/N 25928-06. All models require ECM calibration with Screamin' Eagle Pro Street Tuner for proper installation.

THE PERFORMANCE

- The rider will feel exceptional acceleration, delivering significant gains and up to a 40% increase in the higher RPM range, when compared to the Original Equipment engine configurations.

When installed by an authorized Harley-Davidson® Dealer within 60-days of the vehicle purchase, compliant kits do not impact the vehicle's limited warranty.



Stage IV – 117CI to 117CI – Air/Oil-Cooled

92500076 CVO Black Granite. **\$2,699.95**
Fits '18-later CVO™ FLHXSE and FLTRXSE models equipped with air/oil cooled 117CI Milwaukee-Eight engine. Requires separate purchase of Cam Drive Retention Kit P/N 25566-06. Installation may require Cam Spacer Kit P/N 25928-06. All models require ECM calibration with Screamin' Eagle Pro Street Tuner for proper installation.

Stage IV – 107CI to 114CI – Twin-Cooled™

92500060 Black Highlighted. **\$2,699.95**
Fits '17-later Touring models equipped with Twin-Cooled 107CI Milwaukee-Eight engine. Does not fit Trike models. Requires separate purchase of Cam Drive Retention Kit P/N 25566-06. Installation may require Cam Spacer Kit P/N 25928-06. All models require ECM calibration with Screamin' Eagle Pro Street Tuner for proper installation.

Stage IV – 114CI to 117CI or 117CI to 117CI – Twin-Cooled

Fits '17-later CVO Touring models equipped with 114CI or 117CI Milwaukee-Eight engine. Requires separate purchase of Cam Drive Retention Kit P/N 25566-06. Installation may require Cam Spacer Kit P/N 25928-06. All models require ECM calibration with Screamin' Eagle Pro Street Tuner for proper installation.

92500088 Black Highlighted. **\$2,595.95**
92500064 CVO Black Granite. **\$2,699.95**

Street legal and/or street compliant statements refer to product meeting 50-State emissions and noise standards in the United States.

The street legal and/or street compliant statements may not apply to markets outside of the United States.

Notice: The prices appearing in this catalog are the manufacturer's suggested retail prices. Actual retail prices may vary.



NEW

SCREAMIN' EAGLE® 465

Milwaukee-Eight® Stage Inserts

B. SCREAMIN' EAGLE® STAGE INSERTS

Showcase your bike's performance enhancements with the Screamin' Eagle® Stage Inserts. The Stage Inserts are made to complement the Screamin' Eagle Timer Cover Base (sold separately).

Fits '18-later Softail® and '17-later Touring and Trike models equipped with Screamin' Eagle Timer Cover Base P/N 25600117.

1. 25600118	107 Stage I.	\$14.95
2. 25600119	107 Stage II.	\$14.95
3. 25600132	114 Stage I.	\$14.95
4. 25600120	114 Stage II.	\$14.95
5. 25600121	114 Stage III.	\$14.95
6. 25600122	114 Stage IV.	\$14.95
7. 25600123	117 Stage II.	\$14.95
8. 25600124	117 Stage III.	\$14.95
9. 25600125	117 Stage IV.	\$14.95

Shown with:

10. SCREAMIN' EAGLE TIMER COVER BASE

Showcase your bike's performance enhancements with the Screamin' Eagle Timer Cover Base. Start with this black Timer Cover and then select a Screamin' Eagle Stage Upgrade Insert that matches your engine size and Stage upgrades. (Inserts sold separately)

25600117 **\$29.95**

Fits '18-later Softail and '17-later Touring and Trike models. Requires separate purchase of Screamin' Eagle Stage Insert.

B. SCREAMIN' EAGLE STAGE INSERTS – 107 STAGE 1 (SHOWN ON SCREAMIN' EAGLE TIMER COVER BASE)



NEW

SCREAMIN' EAGLE

B. SCREAMIN' EAGLE STAGE INSERTS & TIMER COVER BASE

Street legal and/or street compliant statements refer to product meeting 50-State emissions and noise standards in the United States.

The street legal and/or street compliant statements may not apply to markets outside of the United States.

Notice: The prices appearing in this catalog are the manufacturer's suggested retail prices. Actual retail prices may vary.

466 SCREAMIN' EAGLE®

Twin Cam Stage Upgrades

TWIN CAM POWERTRAIN

Screamin' Eagle® Stage upgrades offer complete street-compliant performance configurations engineered to generate specific torque and horsepower gains. Eliminating all the guesswork and trial-and-error testing normally associated with engine modifications, Stage upgrades include everything you need to enhance your bike's performance.



STAGE I

INTAKE + EXHAUST + TUNING

The easiest and most cost effective step to improve your motorcycle's performance is to increase the air flow into and out of the engine. A high-flow air cleaner and system-matched slip-on mufflers provide horsepower and torque improvements you can feel throughout the RPM range, and serve as the core components for all performance upgrades. ECM calibration is required to tune the fuel flow and timing required to accommodate the improved air flow.

Stage I upgrade can be installed without engine disassembly. No special tools are required. Requires ECM tuning.

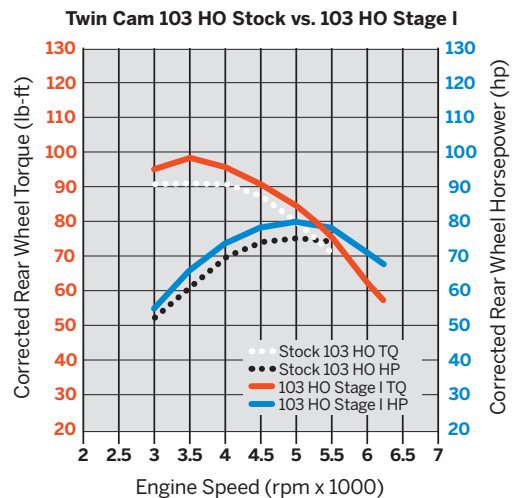

STAGE II

STAGE I + CAM UPGRADE

Adding performance cams to a Stage I equipped bike is the next step to improved performance. Cam choices allow you to tailor the engine's performance to your specific needs. A torque cam offers on-demand throttle response from low- to mid-RPM at cruising speed. A power cam targets high-rpm, wide-open throttle response that keeps pulling right up to redline. ECM calibration tuning is required to accommodate the increased valve timing, and performance valve springs may be required for high-lift cams.



Stage II upgrade requires minor engine disassembly to replace the cam. Adjustable pushrods allow cam installation without removing the rocker box. Special tools and ECM tuning are required.



STAGE III

STAGE I + CAMS, BIG BORE CYLINDERS & PISTONS

The next step on the performance journey is to build a bigger engine. An increase in engine displacement allows the engine to swallow more air and fuel, a higher compression piston squeezes the air/fuel into a more volatile mixture, and when combined, generates more power when ignited. A displacement and compression increase provides torque increases throughout the entire RPM range with a 15-25% improvement in the mid-range power. ECM calibration tuning is required to adjust fuel flow and timing to accommodate the increased displacement.



Stage III bolt-on upgrade requires removal of the engine's top-end and opening the cam chest. Engine remains in the chassis and no machining is required. Special tools and ECM tuning are required.



STAGE IV

STAGE I + CAMS, BIG BORE CYLINDERS, PISTONS, CYLINDER HEADS & THROTTLE BODY

To maximize the impact of the increased displacement gained with Stage III updates, the addition of free-flowing ported cylinder heads and a big bore throttle body top off the performance build. Designed to satisfy the high RPM, throttle twisting rider, the Stage IV update delivers 20-30% increase in power that keeps pulling right up to the redline, without sacrificing mid-range torque. ECM calibration tuning is required to add more fuel, and a higher-lift cam may be required to deliver maximum power.



Stage IV bolt-on upgrade requires removal of the engine's top-end and opening the cam chest. Engine remains in the chassis and no machining is required. Special tools and ECM tuning are required.



Street legal and/or street compliant statements refer to product meeting 50-State emissions and noise standards in the United States.

The street legal and/or street compliant statements may not apply to markets outside of the United States.

468 SCREAMIN' EAGLE®

Twin Cam Stage I Upgrade

A. SCREAMIN' EAGLE® HEAVY BREATHER ELITE PERFORMANCE AIR CLEANER KIT

Really open it up. This Heavy Breather Elite Air Cleaner features a forward-facing filter element that flows huge volumes of clean air. The low-profile cast elbow and the oval cross-section element combine to hug the engine to provide increased leg room. The intake tube mounts to a custom back plate that features integral breathers and covers the throttle body and electronics for a finished look. Available in your choice of chrome or gloss black finish, the Heavy Breather Elite kit features a washable and re-chargeable filter and features bright chrome end caps and trim with Screamin' Eagle script. Kit includes filter, intake tube, custom back plate, water-repellent rain sock and all mounting hardware. 50-State U.S. EPA compliant.

Fits '16-'17 FXDLS and Softail®, '11-'17 CVO™ Softail and '14-'16 Touring and Freewheeler® models. Does not fit models equipped with Twin-Cooled™ engine, fairing lower glove boxes or fairing lower speakers. Also fits '16-'17 FXDLS and Softail, '14-'17 CVO Softail and '14-'16 Touring models equipped with Screamin' Eagle® 58mm Throttle Body. All models require ECM calibration for proper installation. '17-later models require recalibration with Screamin' Eagle Pro Street Tuner (sold separately).

29400173	Chrome.	\$399.95
29400285	Full Gloss Black.	\$399.95

NOTE: The washable and rechargeable filter uses a special coating to help filter fine particles from the incoming air. With time, the oil in the filter will dissipate and the element will begin to turn gray. The original red color can be restored with an application of K&N® Air Filter Oil.



A. SCREAMIN' EAGLE HEAVY BREATHER ELITE PERFORMANCE AIR CLEANER KIT – CHROME



A. SCREAMIN' EAGLE HEAVY BREATHER ELITE PERFORMANCE AIR CLEANER KIT – FULL GLOSS BLACK



A. SCREAMIN' EAGLE HEAVY BREATHER ELITE PERFORMANCE AIR CLEANER KIT

Street legal and/or street compliant statements refer to product meeting 50-State emissions and noise standards in the United States.

The street legal and/or street compliant statements may not apply to markets outside of the United States.

Notice: The prices appearing in this catalog are the manufacturer's suggested retail prices. Actual retail prices may vary.

SCREAMIN' EAGLE® 469

Twin Cam Stage I Upgrade



B. SCREAMIN' EAGLE HEAVY BREATHER PERFORMANCE AIR CLEANER KIT – CHROME



B. SCREAMIN' EAGLE HEAVY BREATHER PERFORMANCE AIR CLEANER KIT – GLOSS BLACK



B. SCREAMIN' EAGLE HEAVY BREATHER AIR CLEANER KIT – COMPACT



B. SCREAMIN' EAGLE HEAVY BREATHER PERFORMANCE AIR CLEANER KIT – CHROME



B. SCREAMIN' EAGLE HEAVY BREATHER PERFORMANCE AIR CLEANER KIT – GLOSS BLACK

B. SCREAMIN' EAGLE® HEAVY BREATHER PERFORMANCE AIR CLEANER KIT

This high-flow forward-facing exposed element Air Cleaner Kit is sure to turn heads at the starting line. Featuring a polished elbow and exposed filter, this unique air cleaner system offers improved performance and airflow when compared to the stock or Screamin' Eagle® High-Flow Air Cleaner. The washable and rechargeable filter features a bright chrome end cap with a laser-engraved Screamin' Eagle logo. Intake tube and back plate are made from die-cast lightweight aluminum and are polished and chrome-plated or painted black for a brilliant finish. The back plate features integral breathers and sealed breather bolt plug. Kit includes a water-repellent rain sock and all mounting hardware. 50-State U.S. EPA compliant.

Fits '16-'17 Softail®, '11-'17 CVO™ Softail, '08-'16 Touring and '15-'16 Freewheeler® models. Also fits '16-'17 FXDLS and Softail, '14-'17 CVO Softail and '14-'16 Touring models equipped with Screamin' Eagle 58mm Throttle Body. Does not fit models equipped with fairing lower glove boxes or fairing lower speakers. Does not fit Twin-Cooled™ models. All models require ECM calibration for proper installation. '17 models require recalibration with Screamin' Eagle Pro Street Tuner (sold separately).

29253-08C	Chrome.	\$329.95
29006-09C	Gloss Black.	\$329.95

Fits '08-'16 Touring and '15-'16 Freewheeler models equipped with Fairing Lower Glove Boxes (except Twin-Cooled models or models equipped with fairing lower speakers). Also fits '16-'17 FXDLS and Softail, '14-'17 CVO Softail and '14-'16 Touring models equipped with Screamin' Eagle 58mm Throttle Body. All models require ECM calibration for proper installation. '17 models require recalibration with Screamin' Eagle Pro Street Tuner (sold separately).

28716-10A	Compact Design – Chrome.	\$329.95
------------------	--------------------------	-----------------

Fits '08-'17 Dyna® (except '16-'17 FXDLS) and '08-'15 Softail models (except '14-'15 FLSTNSE, '11-'12 FLSTSE and '13-'14 FXSBSE). All models require ECM calibration for proper installation. '17 models require recalibration with Screamin' Eagle Pro Street Tuner (sold separately).

29299-08A	Chrome.	\$329.95
29098-09A	Gloss Black.	\$329.95

NOTE: The washable and rechargeable filter uses a special coating to help filter fine particles from the incoming air. With time, the oil in the filter will dissipate and the element will begin to turn gray. The original red color can be restored with an application of K&N® Air Filter Oil.

SCREAMIN' EAGLE

Street legal and/or street compliant statements refer to product meeting 50-State emissions and noise standards in the United States.

The street legal and/or street compliant statements may not apply to markets outside of the United States.

Notice: The prices appearing in this catalog are the manufacturer's suggested retail prices. Actual retail prices may vary.

470 SCREAMIN' EAGLE®

Twin Cam Stage I Upgrade

A. SCREAMIN' EAGLE® HEAVY BREATHER FILTER COVER – TEARDROP

Dress up the Heavy Breather Air Cleaner with this radical cover. Manufactured from forged aluminum and precision CNC-machined and polished, these easy-to-install two-piece covers add a rich custom look. Cover is available in mirror-chrome or cut back gloss black finish to match your customizing direction. Kit includes water-repellent rain sock.

Fits models equipped with Screamin' Eagle® Heavy Breather Air Cleaner Kits (except Compact Heavy Breather P/N 28716-10A, Heavy Breather Elite P/N 29400173, 29400172 or 29400285, and Milwaukee-Eight® Heavy Breather P/N 29400263 or 29400264).

29400061A	Cut Back Gloss Black – Side Logo.	\$174.95
28739-10A	Cut Back Gloss Black – End Logo.	\$169.95
28740-10A	Chrome – End Logo.	\$174.95



A. SCREAMIN' EAGLE HEAVY BREATHER FILTER COVER – TEARDROP, CUT BACK GLOSS BLACK – SIDE LOGO

B. SCREAMIN' EAGLE HEAVY BREATHER DECORATIVE ENDCAP – WILLIE G SKULL

Add a sinister touch to your Heavy Breather Air Cleaner. Chrome-plated self-adhesive cover features a forward-facing Willie G Skull medallion.

28720-10 **\$34.95**

Fits models equipped with Screamin' Eagle Heavy Breather Air Cleaner Kits (except Compact Heavy Breather P/N 28716-10A, Heavy Breather Elite P/N 29400173, 29400172 or 29400285, and Milwaukee-Eight Heavy Breather P/N 29400263 or 29400264).



A. SCREAMIN' EAGLE HEAVY BREATHER FILTER COVER – TEARDROP, CHROME



A. SCREAMIN' EAGLE HEAVY BREATHER FILTER COVER – TEARDROP, CUT BACK GLOSS BLACK

C. SCREAMIN' EAGLE HEAVY BREATHER DECORATIVE MEDALLION

Add the finishing touch to your Heavy Breather Air Cleaner by installing this medallion. Featuring a bright chrome-plated die-cast base and contrasting black inlay with diamond cut Screamin' Eagle script. Easy-to-install.

29017-09 **\$21.95**

Fits models equipped with Screamin' Eagle Heavy Breather Air Cleaner Kits (except Compact Heavy Breather P/N 28716-10A, Heavy Breather Elite P/N 29400173, 29400172 or 29400285, and Milwaukee-Eight Heavy Breather P/N 29400263 or 29400264).



B. SCREAMIN' EAGLE HEAVY BREATHER DECORATIVE ENDCAP – WILLIE G SKULL



C. SCREAMIN' EAGLE HEAVY BREATHER DECORATIVE MEDALLION

D. THROTTLE BODY COVER

This cover dresses the area between the Twin Cam cylinders for a custom look. The formed cover hugs the contour and conceals the electronic control module throttle body for a clean appearance. Available in your choice of mirror chrome or gloss black finish. Easy-to-install kit includes gaskets.

Fits '14-'15 FLSTNSE, '11-'12 FLSTSE, '13-'14 FXSBSE, and '16-'17 FXDLS and Softail®, '08-'16 Touring and Trike models equipped with Screamin' Eagle Heavy Breather or Burst Air Cleaner Kit.

61300109	Chrome.	\$59.95
61300110	Gloss Black.	\$59.95



D. THROTTLE BODY COVERS

Street legal and/or street compliant statements refer to product meeting 50-State emissions and noise standards in the United States.

The street legal and/or street compliant statements may not apply to markets outside of the United States.

Notice: The prices appearing in this catalog are the manufacturer's suggested retail prices. Actual retail prices may vary.

SCREAMIN' EAGLE® 471

Twin Cam Stage I Upgrade



E. SCREAMIN' EAGLE VENTILATOR ELITE AIR CLEANER KIT – CHROME



E. SCREAMIN' EAGLE VENTILATOR ELITE AIR CLEANER KIT – GLOSS BLACK



E. SCREAMIN' EAGLE VENTILATOR ELITE AIR CLEANER KIT



F. SCREAMIN' EAGLE VENTILATOR PERFORMANCE AIR CLEANER KIT – CHROME



F. SCREAMIN' EAGLE VENTILATOR PERFORMANCE AIR CLEANER KIT – GLOSS BLACK

E. SCREAMIN' EAGLE® VENTILATOR ELITE AIR CLEANER KIT

This low-profile oval air cleaner features a 360° exposed filter element and a cast back plate designed to provide maximum air flow to the throttle body. This easy-to-install air cleaner produces significant performance gains, while the sleek center bar design cover with carbon fiber inserts add a luxurious touch. This complete kit includes low-profile air cleaner cover, high-flow filter element, back plate, diamond-cut Screamin' Eagle® medallion, protective rain sock and all required installation hardware. Street compliant when used with stock mufflers. 50-State U.S. EPA compliant.

Fits '16-'17 FXDLS and Softail® and '09-'16 Touring and Trike models. Also fits '11-'17 CVO™ Softail models. All EFI models require ECM calibration for proper installation. '17 models require recalibration with Screamin' Eagle Pro Street Tuner (sold separately).

29400217	Chrome.	\$299.95
29400218	Gloss Black.	\$299.95

Fits '16-'17 FXDLS and Softail, '14-'17 CVO Softail and '14-'16 Touring and Trike models equipped with Screamin' Eagle 58mm Throttle Body. All models require ECM calibration for proper installation. '17 models require recalibration with Screamin' Eagle Pro Street Tuner (sold separately).

29400219	Chrome.	\$299.95
29400230	Gloss Black.	\$299.95

Also available:

SCREAMIN' EAGLE VENTILATOR ELITE AIR CLEANER COVER

Add a luxurious finishing touch to your Ventilator Air Cleaner. Designed as a direct replacement for the Screamin' Eagle and CVO Ventilator Air Cleaners, this easy-to-install cover features a sleek center bar design surrounded with carbon fiber inserts. Kit includes low-profile cover, diamond-cut Screamin' Eagle medallion and chrome mounting hardware.

Fits '10-'17 Dyna®, '09-'16 Softail, '09-'16 Touring and Trike models equipped with Ventilator Air Cleaner Kits. Also fits Dyna High Output 103 and CVO models with Original Equipment Ventilator Air Cleaner.

61300516	Chrome.	\$109.95
61300517	Gloss Black.	\$109.95

F. SCREAMIN' EAGLE VENTILATOR PERFORMANCE AIR CLEANER KIT

Stylish low-profile exposed element air cleaner kit provides increased airflow to boost the power of your fuel-injected engine. The track-inspired exposed element adds a purposeful look to the bike and the included waterproof rain sock protects the filter during inclement weather. This easy-to-install kit includes low-profile air cleaner cover, high-flow filter element, back plate, Screamin' Eagle badge, protective rain sock and all required installation hardware. 50-State U.S. EPA compliant.

Fits '10-'17 Dyna (except '16-'17 FXDLS), and '10-'15 Softail models (except '14-'15 FLSTNSE, '11-'12 FLSTSE and '13-'14 FXSBSE). All models require ECM calibration for proper installation. '17 models require recalibration with Screamin' Eagle Pro Street Tuner (sold separately).

28721-10	Chrome.	\$249.95
28722-10	Gloss Black.	\$249.95

Street legal and/or street compliant statements refer to product meeting 50-State emissions and noise standards in the United States.

The street legal and/or street compliant statements may not apply to markets outside of the United States.

Notice: The prices appearing in this catalog are the manufacturer's suggested retail prices. Actual retail prices may vary.

472 SCREAMIN' EAGLE®

Twin Cam Stage I Upgrade

A. SCREAMIN' EAGLE® EXTREME BILLET VENTILATOR AIR CLEANER KIT

The proven, track-inspired exposed element Ventilator Air Cleaner with a unique look. This low-profile oval air cleaner features a 360° exposed filter element for maximum air flow and a stylish machined billet aluminum cover for style. Available in your choice of chrome or cut back gloss black finish, the two-piece billet cover surrounds the filter and features a full color Screamin' Eagle® medallion. The cast back plate ensures smooth air flow to the throttle body and the included rain sock protects the filter and engine from drawing in moisture during inclement weather. This easy-to-install kit includes billet air cleaner cover, high-flow filter element, back plate, protective rain sock and all required installation hardware. 50-State U.S. EPA compliant.

Fits '16-'17 FXDLS and Softail® and '09-'16 Touring and Trike models. Also fits '11-'17 CVO™ Softail models. All models require ECM calibration for proper installation. '17 models require recalibration with Screamin' Eagle Pro Street Tuner (sold separately).

29400163	Chrome.	\$449.95
29400164	Cut Back Gloss Black.	\$449.95

Fits '16-'17 FXDLS and Softail, '14-'17 CVO Softail and '14-'16 Touring and Trike models equipped with Screamin' Eagle 58mm Throttle Body. All models require ECM calibration for proper installation. '17 models require recalibration with Screamin' Eagle Pro Street Tuner (sold separately).

29400223	Chrome.	\$449.95
29400224	Cut Back Gloss Black.	\$449.95

Fits '10-'17 Dyna® (except '16-'17 FXDLS), and '10-'15 Softail models (except '14-'15 FLSTNSE, '11-'12 FLSTSE and '13-'14 FXSBSE). All models require ECM calibration for proper installation. '17 models require recalibration with Screamin' Eagle Pro Street Tuner (sold separately).

29400167	Chrome.	\$449.95
29400168	Cut Back Gloss Black.	\$449.95

NOTE: The washable and rechargeable filter uses a special coating to help filter fine particles from the incoming air. With time, the oil in the filter will dissipate and the element will begin to turn gray. The original red color can be restored with an application of K&N® Air Filter Oil.



A. SCREAMIN' EAGLE EXTREME BILLET VENTILATOR AIR CLEANER KIT – CHROME



A. SCREAMIN' EAGLE EXTREME BILLET VENTILATOR AIR CLEANER KIT – CUT BACK GLOSS BLACK



A. SCREAMIN' EAGLE EXTREME BILLET VENTILATOR AIR CLEANER KIT – CHROME



A. EXTREME BILLET VENTILATOR AIR CLEANER KIT (SHOWN WITH RAIN SOCK)

Street legal and/or street compliant statements refer to product meeting 50-State emissions and noise standards in the United States.

The street legal and/or street compliant statements may not apply to markets outside of the United States.

Notice: The prices appearing in this catalog are the manufacturer's suggested retail prices. Actual retail prices may vary.

SCREAMIN' EAGLE® 473

Twin Cam Stage I Upgrade



B. EXTREME BILLET AIR CLEANER KIT – AGITATOR, CHROME



B. EXTREME BILLET AIR CLEANER KIT – AGITATOR, CUT BACK GLOSS BLACK



B. EXTREME BILLET AIR CLEANER KIT – CHISEL, CHROME



B. EXTREME BILLET AIR CLEANER KIT – CHISEL, CUT BACK GLOSS BLACK



B. EXTREME BILLET AIR CLEANER KIT



B. EXTREME BILLET AIR CLEANER KIT (SHOWN WITH RAIN SOCK)

B. SCREAMIN' EAGLE® EXTREME BILLET AIR CLEANER KIT

The bold styling of this intake system looks just as impressive as the long patch of burnout rubber you just laid down. The forged billet aluminum cover tops off a cast back plate with integral breather for a smooth transition to the throttle body. The race-inspired air cleaner is engineered to flow high volumes of air and the washable pleated element provides the ideal combination of efficiency and engine protection. Available in your choice of style and finish, this easy-to-install kit includes all mounting hardware and rain sock. 50-State U.S. EPA compliant.

Fits '16-'17 FXDLS and Softail® and '08-'16 Touring and Trike models with Original Equipment 50mm Throttle Body. All models require ECM calibration for proper installation. '17 models require recalibration with Screamin' Eagle® Pro Street Tuner (sold separately).

29400064	Agitator – Chrome.	\$349.95
29400063	Agitator – Cut Back Gloss Black.	\$349.95
29400104	Chisel – Chrome.	\$349.95
29400103	Chisel – Cut Back Gloss Black.	\$349.95

Fits '16-'17 FXDLS and Softail, '14-'17 CVO™ Softail and '14-'16 Touring and Trike models equipped with Screamin' Eagle 58mm Throttle Body. All models require ECM calibration for proper installation. '17 models require recalibration with Screamin' Eagle Pro Street Tuner (sold separately).

29400221	Chisel – Chrome.	\$369.95
29400220	Chisel – Cut Back Gloss Black.	\$369.95

Fits '08-'17 Dyna® (except '16-'17 FXDLS), and '08-'15 Softail models (except '14-'15 FLSTNSE, '11-'12 FLSTSE and '13-'14 FXSBSE). All models require ECM calibration for proper installation. '17 models require recalibration with Screamin' Eagle Pro Street Tuner (sold separately).

29400116	Chisel – Cut Back Gloss Black.	\$349.95
29400117	Chisel – Chrome.	\$349.95

NOTE: The washable and rechargeable filter uses a special coating to help filter fine particles from the incoming air. With time, the oil in the filter will dissipate and the element will begin to turn gray. The original red color can be restored with an application of K&N® Air Filter Oil.

Street legal and/or street compliant statements refer to product meeting 50-State emissions and noise standards in the United States.

The street legal and/or street compliant statements may not apply to markets outside of the United States.

Notice: The prices appearing in this catalog are the manufacturer's suggested retail prices. Actual retail prices may vary.

474 SCREAMIN' EAGLE®

Twin Cam Stage I Upgrade

A. SCREAMIN' EAGLE® HIGH-FLOW AIR CLEANER – TWIN CAM

The High-Flow Air Cleaner Kit provides increased airflow to boost the power of your fuel-injected model. Kit features a one-piece cast back plate with integral breather and mounting brackets for simplified installation and a synthetic washable air cleaner element that does not require oiling. Available with a brilliant chrome or black back plate, this round air cleaner element can be dressed with most Original Equipment or accessory air cleaner covers. Or choose to flaunt your performance gains with the open element look, and finish it off with a Rain Sock Kit P/N 28728-10 and custom Air Cleaner Trim from one of the Harley-Davidson® decorative collections. This kit includes air cleaner, back plate, breather and all required hardware. 50-State U.S. EPA compliant.

Fits '16-'17 Softail® and '14-'16 Touring and Trike models (except CVO™ Touring) with Original Equipment 50mm Throttle Body. All models require ECM calibration for proper installation. '17 models require recalibration with Screamin' Eagle® Pro Street Tuner (sold separately).

29400234	Chrome.	\$184.95
29400233	Texture Black.	\$174.95

Fits '08-'15 Softail models (except CVO Softail). Also fits '08-'17 Dyna® models (except '16-'17 FXDLS) equipped with accessory Air Cleaner Cover. Also fits '04-'07 EFI Dyna, '01-'07 EFI Softail, and '02-'07 EFI Touring. FXS, FLS, FLSTSB and '13-'17 FXDB models require separate purchase of Gasket P/N 29591-99 and Screw P/N 29703-00. All models require ECM calibration for proper installation. '17 models require recalibration with Screamin' Eagle Pro Street Tuner (sold separately).

29400240	Chrome.	\$184.95
29400239	Texture Black.	\$174.95

Fits '08-'15 Dyna models with Original Equipment Teardrop Air Cleaner Cover. All models require ECM calibration for proper installation.

29400236	Chrome.	\$184.95
29400235	Texture Black.	\$174.95

Fits '08-'13 Touring and Trike models (except CVO Touring) with Original Equipment 50mm throttle body. All models require ECM calibration for proper installation.

29400238	Chrome.	\$184.95
29400237	Texture Black.	\$174.95

Fits '16-'17 FXDLS and Softail, '14-'17 CVO Softail, and '14-'16 Touring and Trike models equipped with Screamin' Eagle 58mm EFI Throttle Body. Requires separate purchase of an Accessory Air Cleaner Cover. All models require ECM calibration for proper installation. '17 models require recalibration with Screamin' Eagle Pro Street Tuner (sold separately).

29400222	Raw Aluminium.	\$174.95
-----------------	----------------	-----------------



A. HIGH-FLOW AIR CLEANER KIT – CHROME (29400234 SHOWN)



A. HIGH-FLOW AIR CLEANER KIT – BLACK (29400233 SHOWN)



A. HIGH-FLOW AIR CLEANER KIT – BLACK (29400239 SHOWN)



A. HIGH-FLOW AIR CLEANER KIT – CHROME (29400240 SHOWN)



A. HIGH-FLOW AIR CLEANER KIT – BLACK (29400235 SHOWN)



A. HIGH-FLOW AIR CLEANER KIT – CHROME (29400236 SHOWN)

Street legal and/or street compliant statements refer to product meeting 50-State emissions and noise standards in the United States.

The street legal and/or street compliant statements may not apply to markets outside of the United States.

Notice: The prices appearing in this catalog are the manufacturer's suggested retail prices. Actual retail prices may vary.

SCREAMIN' EAGLE® 475

Twin Cam Stage I Upgrade



B. SCREAMIN' EAGLE PERFORMANCE AIR CLEANER KIT – BURST COLLECTION



B. SCREAMIN' EAGLE® PERFORMANCE AIR CLEANER KIT – BURST COLLECTION

Performance and style combined. Designed to complement the Burst Collection, this radical low profile air cleaner features a tuxedo black surround that has been expertly machined to expose the satin aluminum finish below. The billet cover conceals a one-piece cast back plate with integral breather and mounting bracket that promotes smooth air flow into the throttle body. The exposed reverse cone cotton element provides high-volumes of air and the element is washable for maximum efficiency and protection. The complete kit includes Burst Collection trim, backing plate, air cleaner element and all required installation hardware. 50-State U.S. EPA compliant.

29000066 **\$374.95**

Fits '16-'17 Softail® and '08-'16 Touring and Trike models with Original Equipment 50mm throttle body. Also fits '16-'17 FXDLS and Softail, '14-'17 CVO™ Softail and '14-'16 Touring models equipped with Screamin' Eagle® 58mm Throttle Body. All models require ECM calibration for proper installation. '17 models require recalibration with Screamin' Eagle Pro Street Tuner (sold separately).

29400178 **\$374.95**

Fits '08-'17 Dyna® (except FXDLS), and '08-'15 Softail models (except '14-'15 FLSTNSE, '11-'12 FLSTSE and '13-'14 FXSBSE). All models require ECM calibration for proper installation. '17 models require recalibration with Screamin' Eagle Pro Street Tuner (sold separately).

C. SCREAMIN' EAGLE AIR CLEANER TRIM

Dress your air cleaner in the traditional H-D orange and black. Easy-to-install trim features Screamin' Eagle script set against a gloss black background.

61300299 **\$19.95**

Fits '16-'17 Softail (except FLSTFBS and FXSE) and '14-'16 Touring and Trike models with Original Equipment air cleaner cover. Does not fit CVO models.

29503-07 **\$14.95**

Fits '07 Dyna, '07-'15 Softail (except FLSTSB and FXS), '07-'13 Touring and Trike models with Original Equipment air cleaner cover.



C. SCREAMIN' EAGLE AIR CLEANER TRIM (61300299 SHOWN)



C. SCREAMIN' EAGLE AIR CLEANER TRIM (29503-07 SHOWN)

D. SCREAMIN' EAGLE AIR CLEANER RAIN SOCK

Add the open-element look to your Screamin' Eagle High-Flow style Air Cleaner. This easy-to-install kit allows you to replace the traditional Original Equipment air cleaner cover with custom inserts from one of the H-D® Decorative Collections. Kit includes a breathable mesh cover with classic Bar & Shield logo that stretches over the filter to maximize airflow while protecting the exposed element from the rain. Fits traditional cone-shaped air cleaner elements featured in many Screamin' Eagle Twin Cam Stage Kits.

28728-10 **\$25.95**

Fits Screamin' Eagle Round High-Flow Air Cleaner Kits.



D. SCREAMIN' EAGLE AIR CLEANER RAIN SOCK (SHOWN WITH #1 SKULL AIR CLEANER TRIM)



E. SCREAMIN' EAGLE AIR CLEANER BACK PLATE KITS

Finished in brilliant chrome or wrinkle black, these replacement back plates complement the finish of your engine. Cast back plate design features integral breather and mounting brackets for simplified installation.

Fits models equipped with Screamin' Eagle High-Flow Air Cleaner Kits. Installation may require separate purchase of (2) O-Ring P/N 11292, (2) Breather Tube P/N 29557-05 and (2) Breather Screw P/N 29465-99. See your Dealer for details.

Fits '99-'07 Dyna, '99-'15 Softail (except '11-later CVO) and '02-'07 Touring models.

29510-05 Chrome. **\$59.95**

29586-06 Wrinkle Black. **\$49.95**

Fits '08-'13 Touring and Trike models.

29624-08 Chrome. **\$59.95**

29319-08 Wrinkle Black. **\$49.95**

Fits '08-'15 Dyna models with Original Equipment Teardrop Air Cleaner Cover.

29170-08 Chrome. **\$59.95**

29119-08 Wrinkle Black. **\$49.95**

Street legal and/or street compliant statements refer to product meeting 50-State emissions and noise standards in the United States.

The street legal and/or street compliant statements may not apply to markets outside of the United States.



Multi-Fit

'08-'13 Touring

'08-'15 Dyna

E. SCREAMIN' EAGLE AIR CLEANER BACK PLATE KITS

Notice: The prices appearing in this catalog are the manufacturer's suggested retail prices. Actual retail prices may vary.

SCREAMIN' EAGLE

476 SCREAMIN' EAGLE®

Twin Cam Stage I Upgrade

A. SCREAMIN' EAGLE® STREET PERFORMANCE SLIP-ON MUFFLERS – DYNA® SHORTY DUAL

Factory engineers tuned these pipes to satisfy the most discriminating Harley enthusiast. Mufflers feature high-flowing internals to maximize performance and a rich, deep exhaust note that lets everyone know you're around. With the aggressive sound quality and performance comparable to Screamin' Eagle® II race-use mufflers, it's hard to believe they are street compliant. Available in your choice of rich chrome or heat-resistant jet black ceramic finish. Jet black mufflers include matching muffler shield with a deep embossed Screamin' Eagle logo along the flank. Chrome mufflers allow for the reuse of stock muffler shields or the separate purchase of Chrome "Screamin' Eagle" Script Muffler Shields. 50-State U.S. EPA compliant.

Fits '07-'17 FXDB, '07-'10 FXD, '07-'14 FXDC, '07-'13 FXDL and '07-'08 FXDWG models with Shorty Dual exhaust. Installation requires separate purchase of Muffler Clamps P/N 65296-95A (Qty 2). All models require ECM calibration for proper installation. '17 models require recalibration with Screamin' Eagle Pro Street Tuner (sold separately).

80678-08	Chrome.	\$474.95
80794-10A	Jet Black w/ Muffler Shields.	\$524.95

B. SCREAMIN' EAGLE STREET PERFORMANCE MUFFLERS – DYNA STAGGERED DUAL

Make your statement before they see you coming. The throaty Screamin' Eagle Street Performance sound sets the tone and the bold styling drives the note home. One-of-a-kind ballistic inlet shape flows back past the embossed Screamin' Eagle logo to the unique "Blunt Revolver" end treatment. Available in your choice of brilliant chrome or tough jet black ceramic finish, the mufflers feature complementing end caps with cut-out chambers that expose the finish below for a bold contrast. Complete the look with Jet Black Exhaust Shields (sold separately). 50-State U.S. EPA compliant.

Fits '08-'17 FXDF and '10-'17 FXDWG models. Installation requires separate purchase of Muffler Clamps P/N 65296-95A (Qty 2). All models require ECM calibration for proper installation. '17 models require recalibration with Screamin' Eagle Pro Street Tuner (sold separately).

80674-08A	Chrome w/ Black End Caps.	\$399.95
80601-09A	Jet Black w/ Chrome End Caps.	\$424.95



A. SCREAMIN' EAGLE STREET PERFORMANCE SLIP-ON SHORTY DUAL MUFFLERS – CHROME



A. SCREAMIN' EAGLE STREET PERFORMANCE SLIP-ON SHORTY DUAL MUFFLERS – JET BLACK WITH MUFFLER SHIELDS (SHOWN WITH JET BLACK EXHAUST SHIELD KIT)



B. SCREAMIN' EAGLE STREET PERFORMANCE STAGGERED DUAL MUFFLERS – CHROME WITH BLACK END CAPS



B. SCREAMIN' EAGLE STREET PERFORMANCE STAGGERED DUAL MUFFLERS – JET BLACK WITH CHROME END CAPS (SHOWN WITH JET BLACK EXHAUST SHIELD KIT)

Street legal and/or street compliant statements refer to product meeting 50-State emissions and noise standards in the United States.

The street legal and/or street compliant statements may not apply to markets outside of the United States.

Notice: The prices appearing in this catalog are the manufacturer's suggested retail prices. Actual retail prices may vary.

SCREAMIN' EAGLE® 477

Twin Cam Stage I Upgrade



C. SCREAMIN' EAGLE NIGHTSTICK 2-INTO-1 SLIP-ON MUFFLERS – FLD MODELS



C. SCREAMIN' EAGLE NIGHTSTICK 2-INTO-1 SLIP-ON MUFFLERS – FXDL MODELS (SHOWN WITH JET BLACK EXHAUST SHIELD KIT)



D. JET BLACK EXHAUST SHIELD KIT



E. JET BLACK EXHAUST SHIELD KIT – DYNA STAGGERED DUAL



F. JET BLACK EXHAUST SHIELD KIT

C. SCREAMIN' EAGLE® NIGHTSTICK 2-INTO-1 SLIP-ON MUFFLERS – DYNA®

Tuned by the factory for the ultimate combination of improved performance, rich tone and legal sound levels, these 50-state street compliant slip-on mufflers are the perfect match for your Dyna® Switchback™ or Low Rider® model. The high-flow design of the external diffusion discs produces plenty of low-end "guts" to get your bike away from the light and a fat torque curve that gets you quickly around slow-moving traffic. The flared opening, multiple stainless steel diffusion discs and domed end cap deliver an aggressive raspy sound. Available in mirror chrome and jet black finish, these long and lean pipes feature an embossed Screamin' Eagle logo. Easy-to-install. 50-State U.S. EPA compliant.

Fits '12-'16 FLD models. All models require ECM calibration for proper installation.

80872-12	Chrome.	\$274.95
64900137	Jet Black.	\$329.95

Fits '14-'17 FXDL models. Does not fit FXDLs. All models require ECM calibration for proper installation. '17 models require recalibration with Screamin' Eagle® Pro Street Tuner (sold separately).

64900243	Chrome.	\$324.95
64900242	Jet Black.	\$349.95

D. JET BLACK EXHAUST SHIELD KIT – DYNA SHORTY DUAL

Extend the custom look along the bike's entire profile. These formed steel exhaust shields are available in a unique jet black ceramic finish that complements jet black Screamin' Eagle® Street Performance Slip-On Mufflers. This exhaust shield kit has survived stringent Harley-Davidson testing for durability and corrosion resistance. Manufactured to Original Equipment standards for exact fit, the easy-to-install kit includes front and rear head pipe shields.

80821-10		\$159.95
Fits '06-'10 FXD, '06-'17 FXDB, '06-'14 FXDC, '06-'13 FXDL and '06-'08 FXDWG models with shorty dual exhaust.		

E. JET BLACK EXHAUST SHIELD KIT – DYNA STAGGERED DUAL

Add a custom touch to your ride. These formed steel exhaust shields are available in a tough jet black ceramic that looks just right when paired with jet black Screamin' Eagle Street Performance Slip-On Mufflers. The jet-black coating adds a sinister look to your bike's profile. The slotted "tommy gun" cutouts expose the head pipe for a raw, rebellious attitude. Manufactured to Original Equipment standards for exact fit, this easy-to-install kit includes front and rear head pipe shields.

65247-09		\$229.95
Fits '08-'17 FXDF and '10-'17 FXDWG models with forward controls.		

F. JET BLACK EXHAUST SHIELD KIT – DYNA 2-INTO-1

Extend the blacked-out look along the bike's entire profile. These formed steel exhaust shields feature a unique jet black ceramic coating that complements the jet black Screamin' Eagle Street Performance Slip-On Mufflers. The jet black coating maintains its uniform black finish and has survived stringent Harley-Davidson testing for durability and corrosion resistance. Manufactured to Original Equipment standards for exacting fit, the easy-to-install kit includes front and rear head pipe shields.

65400088		\$199.95
Fits '12-'16 FLD models.		
65400172		\$199.95
Fits '14-'17 FXDL models equipped with Nightstick Muffler P/N 64900242 or 64900243.		

Street legal and/or street compliant statements refer to product meeting 50-State emissions and noise standards in the United States.

The street legal and/or street compliant statements may not apply to markets outside of the United States.

Notice: The prices appearing in this catalog are the manufacturer's suggested retail prices. Actual retail prices may vary.

478 SCREAMIN' EAGLE®

Twin Cam Stage I Upgrade

A. SCREAMIN' EAGLE® STREET CANNON SLIP-ON MUFFLERS – SOFTAIL® SHOTGUN

These 3.25" street compliant high-flow mufflers have been specifically tuned to deliver an aggressive exhaust note and improved performance while preserving the peace with your neighbors. Available in your choice of rich chrome or heat resistant jet black ceramic finish. The Jet Black mufflers include Screamin' Eagle® muffler shields. Complete the look with your choice of 3.25" endcaps (sold separately). 50-State U.S. EPA compliant.

Fits '07-'17 FLS, FLSTN and FLSTSB models equipped with Shotgun exhaust. Does not fit FLSS. Installation requires separate purchase of 3.25" End Caps and Muffler Clamps P/N 65296-95A (Qty 2). All models require ECM calibration for proper installation. '17 models require recalibration with Screamin' Eagle Pro Street Tuner (sold separately).

64900335	Chrome.	\$474.95
64900334	Jet Black w/Muffler Shields.	\$524.95

Fits '07-'17 FLSTF, FLSTFB and FXS models equipped with Shotgun exhaust. Installation requires separate purchase of 3.25" End Caps and Muffler Clamps P/N 65296-95A (Qty 2). All models require ECM calibration for proper installation. '17 models require recalibration with Screamin' Eagle Pro Street Tuner (sold separately).

64900340	Chrome.	\$474.95
64900341	Jet Black w/Muffler Shields.	\$524.95

B. SCREAMIN' EAGLE STREET CANNON SLIP-ON MUFFLERS – SOFTAIL SHORTY DUAL

These 3.25" street compliant high-flow mufflers have been specifically tuned to deliver an aggressive exhaust note and improved performance while preserving the peace with your neighbors. Available in your choice of rich chrome or heat resistant jet black ceramic finish. The Jet Black mufflers include Screamin' Eagle muffler shields. Complete the look with your choice of 3.25" endcaps (sold separately). 50-State U.S. EPA compliant.

Fits '07-'17 FLSTC and FXSB models equipped with Staggered Shorty Dual exhaust. Installation requires separate purchase of 3.25" End Caps and Muffler Clamps P/N 65296-95A (Qty 2). All models require ECM calibration for proper installation. '17 models require recalibration with Screamin' Eagle Pro Street Tuner (sold separately).

64900342	Chrome.	\$474.95
64900343	Jet Black w/Muffler Shields.	\$524.95



A. SCREAMIN' EAGLE STREET CANNON SLIP-ON MUFFLERS – SOFTAIL SHOTGUN, CHROME (SHOWN WITH CHROME SLASH END CAPS)



A. SCREAMIN' EAGLE STREET CANNON SLIP-ON MUFFLERS – SOFTAIL SHOTGUN, JET BLACK (SHOWN WITH JET BLACK SLASH END CAPS AND EXHAUST SHIELDS)



B. SCREAMIN' EAGLE STREET CANNON SLIP-ON MUFFLERS – SOFTAIL SHORTY DUAL, CHROME (SHOWN WITH BILLET CHROME END CAPS)



B. SCREAMIN' EAGLE STREET CANNON SLIP-ON MUFFLERS – SOFTAIL SHORTY DUAL, JET BLACK (SHOWN WITH SATIN BLACK END CAPS AND JET BLACK EXHAUST SHIELDS)

NOTE: There is no warranty on exhaust pipes and mufflers with regard to any discoloration. Blueing is caused by tuning characteristics, cam timing, carburetor jetting, over-heating, etc. and is not caused by defective manufacturing.

Street legal and/or street compliant statements refer to product meeting 50-State emissions and noise standards in the United States.

The street legal and/or street compliant statements may not apply to markets outside of the United States.

Notice: The prices appearing in this catalog are the manufacturer's suggested retail prices. Actual retail prices may vary.

SCREAMIN' EAGLE® 479

Twin Cam Stage I Upgrade



C. MUFFLER END CAPS – 3.25"

C. MUFFLER END CAPS – 3.25"

These easy-to-install caps allow you to finish your 3.25" Screamin' Eagle® mufflers your way. Sold in pairs. Installation hardware included.

Fits '14-later XL and '07-'17 Softail® models equipped with Screamin' Eagle 3.25" Street Cannon Mufflers.

65100049	Billet Chrome Slash Cut.	\$119.95
65100048A	Satin Black Anodized.	\$119.95
65100044	Chrome – Slash Up/Down/Out.	\$99.95
65100063	Jet Black – Slash Up/Down/Out.	\$109.95

D. JET BLACK EXHAUST SHIELD KIT – SOFTAIL®

Extend the blacked-out look along the bike's entire profile. These formed steel exhaust shields feature a unique jet black ceramic coating that complements the jet black Screamin' Eagle Street Performance Slip-On Mufflers. The jet black coating maintains its uniform black finish and has survived stringent Harley-Davidson testing for durability and corrosion resistance. Manufactured to Original Equipment standards for exacting fit, the easy-to-install kit includes front and rear head pipe shields.

1. 80817-10A **\$199.95**

Fits '07-'17 FLSTF, FLSTFB and FLSTFBS, '11-'13 FXS and '07 FXSTD models equipped with shotgun exhaust.

2. 80829-10A **\$199.95**

Fits '07-'17 FLS, FLSS, FLSTN and FLSTSB models.

3. 80818-10 **\$159.95**

Fits '08-'11 FXCW and FXCWC, '13-'17 FXSB, '16-'17 FXSE and '13-'14 FXSBSE models equipped with shortly dual exhaust.



D. JET BLACK EXHAUST SHIELD KIT – SOFTAIL



D. JET BLACK EXHAUST SHIELD KIT – SOFTAIL

E. SCREAMIN' EAGLE® SLASH CUT MUFFLER SHIELDS – SATIN BLACK

Shaped to mirror the slash down profile of available muffler end caps, this set of rich satin black Muffler Shields is the perfect complement to your blacked-out exhaust system. The rear shield features a subtle laser-etched Screamin' Eagle script. Easy-to-install kit includes front and rear shields and black mounting hardware.

65400405 Satin Black. **\$129.95**

Fits '07-later XL, '07-'17 Dyna® (except '08-'17 FLD, FXDF, FXDL, FXDLS and '10-'17 FXDWG) and '07-'17 Softail® models equipped with Screamin' Eagle Street Performance mufflers.



D. JET BLACK EXHAUST SHIELD KIT – SOFTAIL



E. SCREAMIN' EAGLE SLASH CUT MUFFLER SHIELDS – SATIN BLACK

F. SCREAMIN' EAGLE SLASH CUT MUFFLER SHIELDS – CHROME

Styled to complement the ballistic inlet shape of the Screamin' Eagle Street Performance Slip-On Mufflers. The slash-cut rear shield features a laser-etched Screamin' Eagle signature script. Easy-to-install kit includes front and rear shields and mounting hardware.

65400464 Chrome. **\$69.95**

Fits '07-later XL, '07-'17 Dyna (except '08-'17 FLD, FXDF, FXDL, FXDLS and '10-'17 FXDWG) and '07-'17 Softail models equipped with Screamin' Eagle Street Performance Mufflers.



F. SCREAMIN' EAGLE SLASH CUT MUFFLER SHIELDS – CHROME



G. SCREAMIN' EAGLE MUFFLER SHIELDS

G. SCREAMIN' EAGLE MUFFLER SHIELDS

Styled to complement the ballistic inlet shape of the Screamin' Eagle Street Performance Slip-On Mufflers. The rear shield features a deep embossed Screamin' Eagle signature script. Available in chrome and jet black. Easy-to-install kit includes front and rear shields and mounting hardware.

Fits '07-later XL, '07-'17 Dyna (except '08-'17 FLD, FXDF, FXDL and '10-later FXDWG) and '07-'17 Softail models equipped with Screamin' Eagle Street Performance Mufflers.

64806-07A Chrome. **\$59.95**

65400078 Jet Black. **\$129.95**

NOTE: There is no warranty on exhaust pipes and mufflers with regard to any discoloration. Blueing is caused by tuning characteristics, cam timing, carburetor jetting, over-heating, etc. and is not caused by defective manufacturing.

Street legal and/or street compliant statements refer to product meeting 50-State emissions and noise standards in the United States.

The street legal and/or street compliant statements may not apply to markets outside of the United States.

Notice: The prices appearing in this catalog are the manufacturer's suggested retail prices. Actual retail prices may vary.

480 SCREAMIN' EAGLE®

Twin Cam Stage I Upgrade

A. SCREAMIN' EAGLE® STREET CANNON PERFORMANCE SLIP-ON MUFFLERS – 4.0"

Cue the orchestra. We tuned these mufflers to provide an exhaust note with some extra deep bass. You get the rumble you want and enhance that famous Harley sound, while preserving the peace with your neighbors. The tuned baffles work with the large internal volume to strike the perfect balance required to deliver performance that you can feel in your gut. The large 4.0" diameter Street Cannons provide free flow of exhaust gases with just the right amount of back pressure for a smooth-running ride. The die-cast Screamin' Eagle® medallion adds a rich touch to your bike's profile and a large selection of end cap designs are available (sold separately) to provide the perfect finishing touch. 50-State U.S. EPA compliant.

Fits '09-'16 Touring and '09-later Trike models (except CVO™ models and '10 FLHX and FLTRX models). Installation requires separate purchase of 4" end caps and Muffler Clamps P/N 65296-95A (Qty 2). All models require ECM calibration for proper installation. '17-later models require recalibration with Screamin' Eagle Pro Street Tuner (sold separately).

64900186B	Chrome.	\$424.95
64900187B	Jet Black.	\$474.95



A. SCREAMIN' EAGLE STREET CANNON PERFORMANCE MUFFLERS – CHROME
(SHOWN WITH BILLET TAPERED SLASH END CAPS)



A. SCREAMIN' EAGLE STREET CANNON PERFORMANCE MUFFLERS – JET BLACK
(SHOWN WITH BLUNT REVOLVER END CAPS)

Street legal and/or street compliant statements refer to product meeting 50-State emissions and noise standards in the United States.

The street legal and/or street compliant statements may not apply to markets outside of the United States.

Notice: The prices appearing in this catalog are the manufacturer's suggested retail prices. Actual retail prices may vary.

SCREAMIN' EAGLE® 481

Twin Cam Stage I Upgrade

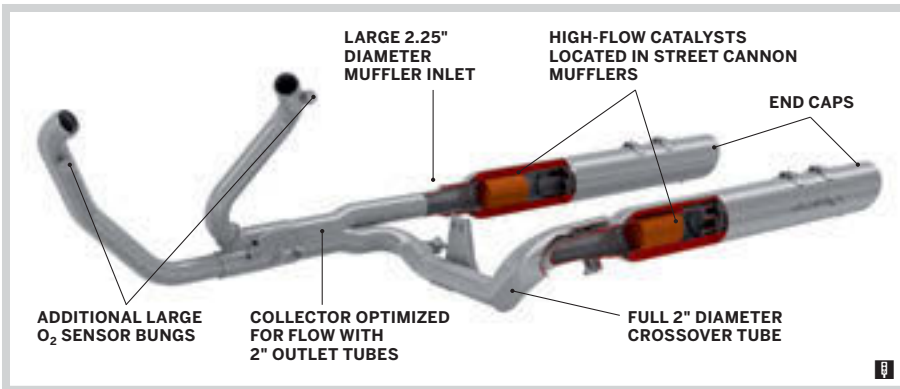

B. SCREAMIN' EAGLE HIGH-FLOW EXHAUST SYSTEM WITH STREET CANNON MUFFLERS

B. SCREAMIN' EAGLE® HIGH-FLOW EXHAUST SYSTEM WITH STREET CANNON MUFFLERS

The Screamin' Eagle® High-Flow Exhaust system provides bolt-on performance by reducing the catalyst restrictions and improving exhaust flow. This exhaust system is optimized for use on engines producing 80+ horsepower and works great with Screamin' Eagle Stage Kits. The kit replaces the stock head pipe and mufflers with large diameter, free-flowing head pipes and matching mufflers. The muffler inlet diameter has been increased to 2.25" to enhance exhaust gas scavenging and the catalysts have been relocated to the mufflers to enhance flow. The proof is in the horsepower and torque numbers. Dial the system to your motorcycle by using the Screamin' Eagle Pro Street Tuner to tune your ECM specifically to match your performance upgrades.

The large 4" diameter Street Cannon mufflers are tuned to provide a deep bass exhaust note and a healthy rumble at idle, and that famous Harley sound throughout the RPM range. 50-State U.S. EPA compliant.

Fits '10-'16 Touring models (except CVO™). Does not fit Trike models. Separate purchase of Screamin' Eagle 4" endcaps required. All models require ECM calibration for proper installation.

64800043	Chrome.	\$1,400.00
64800044	Jet Black.	\$1,500.00



B. SCREAMIN' EAGLE HIGH-FLOW EXHAUST SYSTEM WITH STREET CANNON MUFFLERS – CHROME (SHOWN WITH SHORT SLASH OUT END CAPS)



B. SCREAMIN' EAGLE HIGH-FLOW EXHAUST SYSTEM WITH STREET CANNON MUFFLERS – JET BLACK (SHOWN WITH SATIN BLACK END CAPS)

Twin Cam 103 Stage II High-Flow vs. 103 Stage II with Street Cannons*

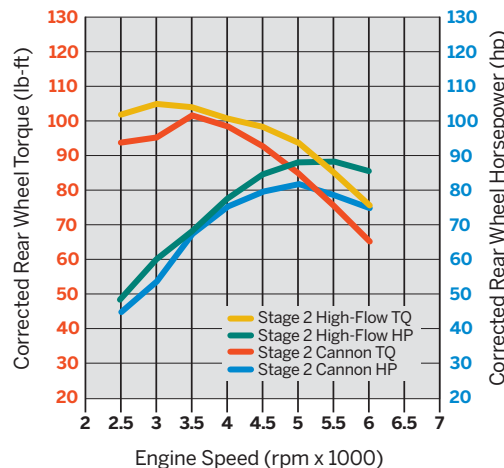

*With SE-585 Cams and Heavy Breather Elite Air Cleaner.



B. HIGH-FLOW EXHAUST – CHROME



B. HIGH-FLOW EXHAUST – JET BLACK

NOTE: There is no warranty on exhaust pipes and mufflers with regard to any discoloration. Blueing is caused by tuning characteristics, cam timing, carburetor jetting, over-heating, etc. and is not caused by defective manufacturing.

Street legal and/or street compliant statements refer to product meeting 50-State emissions and noise standards in the United States.

The street legal and/or street compliant statements may not apply to markets outside of the United States.

Notice: The prices appearing in this catalog are the manufacturer's suggested retail prices. Actual retail prices may vary.

482 SCREAMIN' EAGLE®

Twin Cam Stage I Upgrade

A. BURST COLLECTION 4" END CAPS

Sculpted machining sends reflections of light in all directions. Burst Collection Muffler End Caps feature a rich black anodized finish that is machined to expose the highlights of raw aluminum. The contrasting cut-back look makes a powerful visual statement and works great with both chrome and jet black mufflers.

65100054 **\$199.95**

Fits '09-'16 Touring and '09-later Trike models equipped with Screamin' Eagle® Street Cannon 4" End Cap Mufflers. Does not fit 4" CVO™ Touring mufflers.



A. BURST COLLECTION 4" END CAPS



B. SHORT SLASH UP/DOWN/OUT – 4" MUFFLER END CAPS

B. SHORT SLASH UP/DOWN/OUT 4" MUFFLER END CAPS

These End Cap Kits allow you to personalize your Screamin' Eagle Street Performance Touring Mufflers. The Short Slash Up/Down/Out End Caps are 2" shorter than our traditional Slash Cut End Caps, and keep the mufflers tucked in close to the saddlebag or Trike model rear valance for a clean custom look. Sold in pairs, the kit includes all required mounting hardware.

65100062 **\$89.95**

Fits '09-'16 Touring and '09-later Trike models equipped with Screamin' Eagle Street Cannon 4" End Cap Mufflers. Does not fit 4" CVO Touring mufflers.

C. MUFFLER END CAPS – 4"

These End Cap Kits allow you to personalize your Screamin' Eagle Street Performance Touring Mufflers. Available in your choice of styles, these easy-to-install caps are dressed with the same finish as the mufflers and exhaust shields for a consistent look front to back. Sold in pairs, the kit includes all required mounting hardware.

Fits '09-'16 Touring and '09-later Trike models equipped with Screamin' Eagle Street Cannon 4" End Cap Mufflers. Does not fit 4" CVO Touring mufflers.

65100016	Revolver.	\$99.95
65100015	Piston.	\$99.95
65100019	Slash Up/Down/Out.	\$99.95
65100018	Billet Tapered Slash.	\$149.95
65100017	Fishtail.	\$149.95
65100028	Satin Black Anodized.	\$149.95
80611-09	Blunt Revolver.	\$129.95



C. MUFFLER END CAPS – 4"

D. MUFFLER BRACKET COVER KIT

Stamped-steel cover conceals the Original Equipment exhaust brackets. Contoured for a custom fit, these easy-to-install covers add a distinctive finishing touch. Available in mirror-chrome or black finish to match your customizing style (sold in pairs).

Fits '97-'13 Touring models. Fits Screamin' Eagle Street Performance Touring 4" Mufflers (except P/N 64900093 and 64900091). Does not fit with Fishtail 4.0" Muffler End Cap P/N 65100017. Does not fit with Screamin' Eagle 3.5" Mufflers.

80716-08	Chrome.	\$59.95
80812-10	Black.	\$59.95



D. MUFFLER BRACKET COVER KIT – CHROME



D. MUFFLER BRACKET COVER KIT – BLACK

Street legal and/or street compliant statements refer to product meeting 50-State emissions and noise standards in the United States.

The street legal and/or street compliant statements may not apply to markets outside of the United States.

Notice: The prices appearing in this catalog are the manufacturer's suggested retail prices. Actual retail prices may vary.

SCREAMIN' EAGLE® 483

Twin Cam Stage I Upgrade



E. SCREAMIN' EAGLE FATSHOTZ SLIP-ON MUFFLERS

E. SCREAMIN' EAGLE® FATSHOTZ SLIP-ON MUFFLERS



Provide a performance and style boost to your 2-into-2 exhaust-equipped Touring motorcycle. Designed for easy installation on the Original Equipment header pipes and muffler hangers, these mirror chrome flared mufflers are tuned to maximize airflow while keeping the rich exhaust note within the legal limits. 50-State U.S. EPA compliant.

80847-10 **\$449.95**

Fits '10-'16 Touring and '09-'16 Trike models (except CVO™ and '10 FLHX and FLTRX models). Installation requires separate purchase of Muffler Clamps P/N 65296-95A (Qty. 2). All models require ECM calibration for proper installation. '17-later models require recalibration with Screamin' Eagle® Pro Street Tuner (sold separately).

F. LASER EXHAUST SHIELD KIT

Show-winning style. This kit replaces the factory exhaust shields with a unique and attention-getting design. The shields feature laser cut openings that are filled with tightly-woven mesh that delivers a modern high performance look. Available in chrome or jet black ceramic, the finish is a perfect match for Original Equipment or Screamin' Eagle® mufflers. The easy-to-install kits include front and rear header shield and collector shield.

Fits '09-'16 Touring and Trike models (except '10 FLHX and FLTRX).

65400064 Chrome with Chrome Screens. **\$299.95**

65400117 Jet Black with Stainless Steel Screens. **\$349.95**

G. JET BLACK EXHAUST SHIELD KIT – TOURING

Available for 2-into-1 and 2-into-2 exhaust systems, these formed steel exhaust shields feature a unique jet black ceramic coating that complements the jet black Screamin' Eagle Street Cannon Slip-On Mufflers. The jet black coating maintains its uniform black finish and has survived stringent Harley-Davidson testing for durability and corrosion resistance. Manufactured to Original Equipment standards for exacting fit, the easy-to-install kit includes front and rear head pipe shields.

64981-09 **\$249.95**

Fits '09-'16 Touring and Trike models (except '10 FLHX and FLTRX).



F. LASER EXHAUST SHIELD KIT – CHROME WITH CHROME SCREENS



F. LASER EXHAUST SHIELD KITS



G. JET BLACK EXHAUST SHIELD KIT – TOURING

SCREAMIN' EAGLE

Street legal and/or street compliant statements refer to product meeting 50-State emissions and noise standards in the United States.

The street legal and/or street compliant statements may not apply to markets outside of the United States.

Notice: The prices appearing in this catalog are the manufacturer's suggested retail prices. Actual retail prices may vary.

TWIN CAM STAGE II UPGRADE

Camshafts are a fundamental ingredient in the performance recipe, because they control the timing and duration of all major engine events. They are the primary means by which you can tune your engine's horsepower and torque output. Every cam has unique lift and overlap performance characteristics, which means you need to select cams based on exactly the kind of power you're looking for.



A. SCREAMIN' EAGLE® TWIN CAM PERFORMANCE CAMS



Kits include front and rear cams. Splined rear cam is included for exceptional load handling capability. Gaskets and bearings not included. Cam Installation Kit P/N 17045-99C (sold separately) includes all required gaskets, bearings and seals for proper installation. Dealer installation is recommended and special tools are required for proper installation.

SE-255 CAM KIT

The ultimate in torque cams, this cam offers substantial increase in low end torque for engines up to 110 cubic inches with compression ratios up to 10 to 1. The low end torque increases are great for heavy bikes or for the person who routinely shifts below 4500 RPM and wants the power available to pass without downshifting. The cam still makes peak power above 5000 RPM so people with lighter bikes will enjoy the torque increases without feeling like the bike runs out of air at higher engine speeds. 50-State U.S. EPA compliant.

25638-07 **\$349.95**

For use on '09-'13 Dyna®, Softail®, and '09-'13 Touring and Trike models with 103CI and 110CI engines. All models require ECM calibration for proper installation. Labor cost not included. See Dealer for details.

SE-259E CAM KIT

Developed specifically for big displacement Twin Cam engines, this cam has a modern lobe design that allows for higher valve lifts for a given duration. A high-lift version of the SE-211 camshaft, this cam works great with 103 cubic inch and larger engines with free-flowing intake and exhaust. It can be used with stock heads (updated with race springs) and high-compression pistons for even more torque than a SE-211 cam or can be coupled with any of the performance heads to realize the full power potential. 50-State U.S. EPA compliant.

25482-10 **\$349.95**

For use on '11-'15 103CI and 110CI Touring and Trike models. Installation requires separate purchase of Performance Valve Spring Kit P/N 18013-03A. All models require ECM calibration for proper installation. Labor cost not included. See Dealer for details.

SE-585 CAM KIT

This cam is a great match for riders of heavy Touring bikes looking for big torque at the low end. Just a quick downshift to fourth gear results in an effortless pass of that slow moving tractor-trailer ahead of you. This cam provides an early hit of torque at the low end of the RPM spectrum. A unique combination of lift, cam lobe duration and an enhanced cam profile ramp provides a performance boost you can feel. The cam's QRD (Quiet Ramp Design) delivers high torque throughout the RPM range while reducing valve train noise. 50-State U.S. EPA compliant.

25400117 **\$349.95**

For use on '14-'16 Touring models with the use of a 58mm Throttle Body. Also fits '14-'16 CVO™ Touring models with or without the use of a 58mm Throttle Body. Does not fit Trike models. Installation requires separate purchase of Performance Valve Spring Kit P/N 18013-03A. All models require ECM calibration for proper installation. Labor cost not included. See Dealer for details.

NOTE: Separate purchase of Cam Drive Retention Kit P/N 25566-06 and Cam Spacer Kit P/N 25928-06 may be required. These kits contain five different spacers to achieve proper sprocket alignment. Individual spacers can be purchased separately.

Street legal and/or street compliant statements refer to product meeting 50-State emissions and noise standards in the United States.

The street legal and/or street compliant statements may not apply to markets outside of the United States.

Notice: The prices appearing in this catalog are the manufacturer's suggested retail prices. Actual retail prices may vary.

Twin Cam 103CI Stock vs. 103CI Stage II with SE-255 Cam

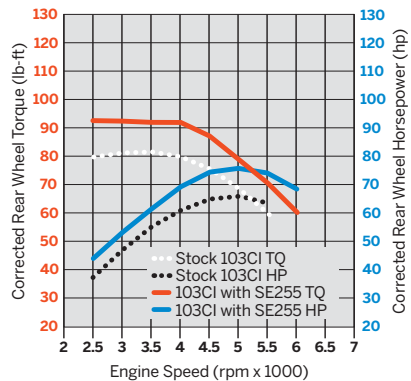

Twin Cam 103CI Stock vs. 103CI Stage II with SE-259E Cam

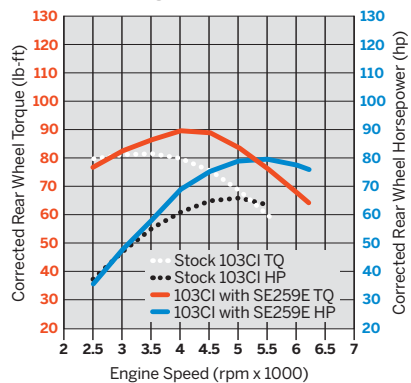

Twin Cam HO103CI Stock vs. 103CI Stage II with SE-585 Cam

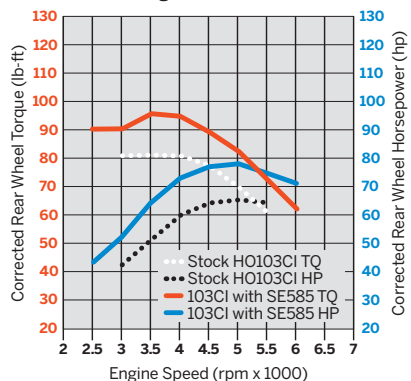

SCREAMIN' EAGLE® 485

Twin Cam Stage II Upgrade



B. SCREAMIN' EAGLE PREMIUM TAPERED QUICK-INSTALL ADJUSTABLE PUSHRODS – CHROME COVERS



B. SCREAMIN' EAGLE PREMIUM TAPERED QUICK-INSTALL ADJUSTABLE PUSHRODS – GLOSS BLACK COVERS

B. SCREAMIN' EAGLE® PREMIUM TAPERED QUICK-INSTALL ADJUSTABLE PUSHRODS

These premium pushrods are tapered for enhanced clearance at the cylinder head, allowing the use of higher lift cams. The one-piece chrome moly tube adds rigidity and durability and the threaded adjustment feature provides easy cam installation without removing the cylinder heads or rocker boxes. To simplify adjustment, the tube features six flats, with one flat marked with a large dot for tracking the adjustment. The threaded rod features 4 flats to reduce wrench swing. Each pushrod features the Screamin' Eagle logo and is marked for "Intake" or "Exhaust." Kit includes 4 pushrods and required pushrod tubes.

Fits '99-'17 Twin Cam-equipped models.

17900032	With Gloss Black Covers.	\$199.95
18404-08	With Chrome Covers.	\$184.95

C. SCREAMIN' EAGLE HIGH-CAPACITY TAPPETS

Screamin' Eagle® Tappets feature large high capacity needles in the roller bearing assembly to improve reliability when operating with high lift cams, high pressure valve springs and in high RPM applications. The 25% larger needle bearings increase the dynamic load rating by approximately 20% when compared to the Original Equipment Twin Cam tappets. The unique design delivers superior tappet life in performance applications. Set of 4.

18572-13 **\$249.95**

Fits '17-later Milwaukee-Eight® Engine equipped models, '00-later XL and XR models and '99-'17 Twin Cam-equipped models.

D. SCREAMIN' EAGLE PERFORMANCE VALVE SPRING KIT*

This performance beehive-shaped Valve Spring Kit will permit the Sportster® engine to rev to 7000 RPM. The unique ovate wire yields increased performance from a compact spring design. The installed spring pressure is increased to 208 lbs and allows a maximum lift of .590". Complete kit includes springs, upper collars and keepers and lower collars with integral valve seals.

18013-03A **\$149.95**

Fits '04-later XL, XR and '05-'17 Twin Cam-equipped models. Does not fit FXDLS, FLSS, FLSTFBFS or Screamin' Eagle Performance Heads with .3125" diameter valves.



C. SCREAMIN' EAGLE HIGH-CAPACITY TAPPETS



D. SCREAMIN' EAGLE PERFORMANCE VALVE SPRING KIT

E. PUSHROD COVER KIT – GLOSS BLACK

Complete the Dark Custom look. These covers replace existing chrome covers to give your bike a blacked-out appearance down to the smallest detail. Pushrod covers are finished in gloss black and the kit includes four bottom cover tubes and the four upper clips. Installation retains the Original Equipment chrome short center tube to create a high-contrast accent. Cover Kit can be installed on engines already equipped with Adjustable Pushrods or can be installed by removing rocker box covers, rocker arms and non-adjustable pushrods. Consult your dealer or service manual for installation.

17900033 Covers Only. **\$69.95**

Fits '99-'17 Twin Cam-equipped models. Requires prior installation of Adjustable Pushrods or removal of rocker box covers, rocker arms and fixed-length pushrods.

F. PUSHROD TUBE COLLARS – GLOSS BLACK

Manufactured from Original Equipment components for perfect fit and function, these Pushrod Collars complete your Twin Cam engine's conversion to the total blacked-out look. Covers replace the chrome-finished factory covers, and fit with stock or Screamin' Eagle Quick-Install Pushrods.

17900076 **\$29.95**

Fits '84-'00 Evolution® 1340 and '99-'17 Twin Cam-equipped models. Installation requires use of Adjustable Pushrods or removal of rocker box covers, rocker arms and fixed-length pushrods.



E. PUSHROD COVER KIT – GLOSS BLACK



F. PUSHROD TUBE COLLARS – GLOSS BLACK

***CAUTION:** Proper valve spring to rocker cover clearance must always be verified during installation of Screamin' Eagle Valve Spring Kits. Failure to have adequate clearance may result in engine damage.

Street legal and/or street compliant statements refer to product meeting 50-State emissions and noise standards in the United States.

The street legal and/or street compliant statements may not apply to markets outside of the United States.

Notice: The prices appearing in this catalog are the manufacturer's suggested retail prices. Actual retail prices may vary.

SCREAMIN' EAGLE

486 SCREAMIN' EAGLE®

Twin Cam Stage II Upgrade

A. SCREAMIN' EAGLE® BILLET CAM SUPPORT PLATE WITH HIGH-VOLUME OIL PUMP

A great upgrade for any performance motor. The Billet Cam Support Plate is manufactured from billet aluminum with pressed-in bronze bushings and is pre-assembled with the crankshaft bushing and oil pressure relief valve. Aluminum is specified at 6061 billet plate, heat-treated to T6 specifications with a surface-hardened anodized finish to provide superior strength, rigidity and durability. CNC-precision machining ensures precise dimensions and constant material thickness across the plate, enabling perfect alignment of cams and chains. Cam bushings are made from 660 bronze materials to provide enhanced wear resistance and to stand up to increased loads from the high lift cams common in large displacement motors. The improved Screamin' Eagle® high-flow oil pump provides higher pressure when the oil is hot to keep pressure drops to a minimum and increases the oil supply by 16% and the scavenging by 29% over the '06-'17 Original Equipment oil pump.

25282-11 **\$439.95**

Fits '06-'17 Dyna® and '07-'17 Softail®, and '07-'16 Touring and Trike models. Installation requires separate purchase of Cam Service Kit P/N 17045-99D and Drive Gear Retention Kit P/N 25566-06.



A. SCREAMIN' EAGLE BILLET CAM SUPPORT PLATE WITH HIGH-VOLUME OIL PUMP

B. SCREAMIN' EAGLE HYDRAULIC CAM CHAIN TENSIONER AND HIGH-FLOW OIL PUMP UPGRADE KIT

This kit updates the cam chain tensioner of your Twin Cam 88® engine to the latest design, as featured on the Twin Cam 96™ engine. The billet cam support plate has been designed to allow the installation of the Twin Cam 96 hydraulic cam chain tensioner to Twin Cam 88-equipped models. These Hydraulic Cam Chain Tensioners will significantly outlast the spring loaded tensioners and are an ideal addition to an engine modified for improved performance. In addition, '02-'06 models utilize a Twin Cam 96 single row front roller chain and sprocket (included in kit). '99-'01 models use Original Equipment front silent chain and sprocket to retain the cam position sensor function. The kit includes an improved Screamin' Eagle High-Flow Oil Pump that provides increased oil pressure at high-operating temperatures. This kit increases the oil supply by 23% and scavenging by 50% when compared to the '99-'05 Original Equipment oil pump and reduces operating temperature of bearings to improve bearing life.

25284-11 **\$509.95**

Fits '99-'05 Dyna, '00-'06 Softail and '99-'06 Touring models. Installation requires separate purchase of Spacer Kit P/N 25285-08, Cam Service Kit P/N 17045-99D and Drive Gear Retention Kit P/N 25566-06.



B. SCREAMIN' EAGLE HYDRAULIC CAM CHAIN TENSIONER AND HIGH-FLOW OIL PUMP UPGRADE KIT

C. SCREAMIN' EAGLE HIGH-PERFORMANCE INNER CAM BEARINGS

High-performance Inner Cam Bearings are a smart upgrade when installing high-lift cams in a race bike. These bearings provide increased load capacity and extend the engine life in extreme racing conditions. Kit includes two bearings required to complete one Twin Cam engine.

24017-10 **\$19.95**

Fits '99-'05 Dyna, '00-'06 Softail and '99-'06 Touring models.

24018-10 **\$19.95**

Fits '06-'17 Dyna, '07-'17 Softail and '07-'16 Touring and Trike models.



New Pump Rotor

Original Pump Rotor

HIGH VOLUME OIL PUMP COMPARISON



C. SCREAMIN' EAGLE HIGH-PERFORMANCE INNER CAM BEARINGS

Street legal and/or street compliant statements refer to product meeting 50-State emissions and noise standards in the United States.

The street legal and/or street compliant statements may not apply to markets outside of the United States.

Notice: The prices appearing in this catalog are the manufacturer's suggested retail prices. Actual retail prices may vary.

STAGE III & IV UPGRADES

Screamin' Eagle® Stage Kits offer complete street-compliant performance configurations engineered to help you generate specific torque and horsepower gains. Eliminating all the guesswork and trial-and-error testing normally associated with engine modifications, Stage Kits include everything you need to enhance your bike's performance, including big-bore cylinders, high-compression pistons, performance cams and high-flow air cleaners.



BOLT-ON
TWIN-CAM 110
BIG BORE
STAGE KITS



HIGH-STRENGTH
CYLINDER LINERS
ARE MACHINED
TO SLIP INTO
THE STOCK CASE
OPENING

FEATURES

BOLT-ON BIG BORE CYLINDERS

In the past, the only way to increase the bore of your 103 or 110 cubic inch Twin Cam V-Twin motor was to tear down the motor and re-bore the engine cases to fit larger bore cylinder spigots. It was a labor-intensive and expensive process. The Screamin' Eagle team has engineered a 4" Big Bore Cylinder and Piston package that increase the internal bore from 3-7/8" to 4", without increasing the outside diameter of the cylinder spigot. The cylinder slips into the existing case bore without modification.

Street legal and/or street compliant statements refer to product meeting 50-State emissions and noise standards in the United States.

The street legal and/or street compliant statements may not apply to markets outside of the United States.



CAST ALUMINUM
CYLINDER

CAST-IN-PLACE
HIGH STRENGTH
STEEL LINER

STEEL LINER FEATURES
TENSILE STRENGTH OF
120,000 PSI – 3 TIMES
STRONGER THAN CAST
IRON SLEEVES

MACHINED SPIGOT

488 SCREAMIN' EAGLE®

Twin Cam Stage III Upgrade

STAGE III

SCREAMIN' EAGLE® TWIN CAM HIGH-COMPRESSION KIT WITH CAMS – 103CI TO 103CI

Give your Touring bike the kick it needs to pass a road hogging RV on a long uphill climb. This street compliant Stage III "in-a-box" kit includes the system-matched components you need to build a performance Twin Cam engine with torque and horsepower characteristics you can use – every day. Designed for use with stock cylinder heads, this kit produces big torque gains at lower RPM while maintaining your factory warranty. This street-performance engine has the potential to produce 88 HP and 100 lb-ft of torque with the stock cylinder heads. 50-State U.S. EPA compliant.

Kit includes:

- Forged 10.5:1 High Compression Pistons and Rings
- SE-585 Cams
- High Performance Valve Springs
- Perfect-Fit Pushrods
- Top End Gasket Kit
- Heavy Duty Clutch Spring

92500028 **\$969.95**

Fits '14-'16 Touring models. Does not fit Trike or models with Twin-Cooled™ engines. Requires separate purchase of outer Primary Cover Gasket. Installation requires separate purchase of Cam Drive Retention Kit P/N 25566-06. May require Cam Spacer Kit P/N 25928-06. All models require ECM calibration for proper installation.

NOTICE: Installation of automatic or manual compression releases on large displacement engines is highly recommended.

When installed by an authorized Harley-Davidson® Dealer within 60-days of the vehicle purchase, compliant kits do not impact the vehicle's limited warranty.

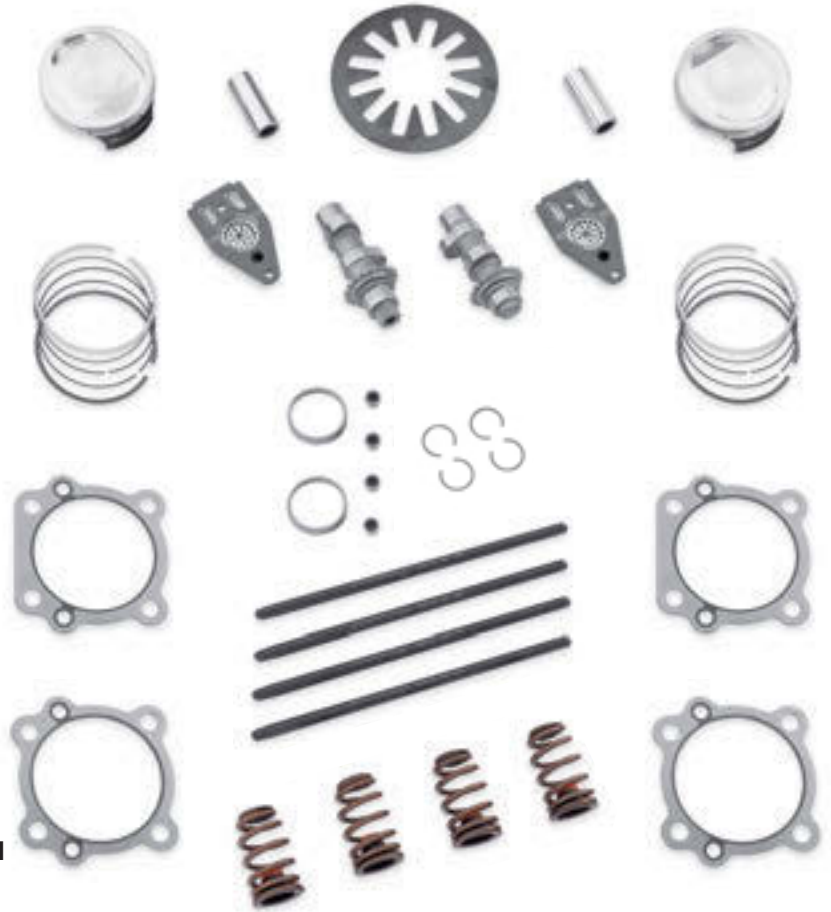

Twin Cam 103HO Stock vs. 103CI High Compression Kits with Cams & Street Cannon Mufflers

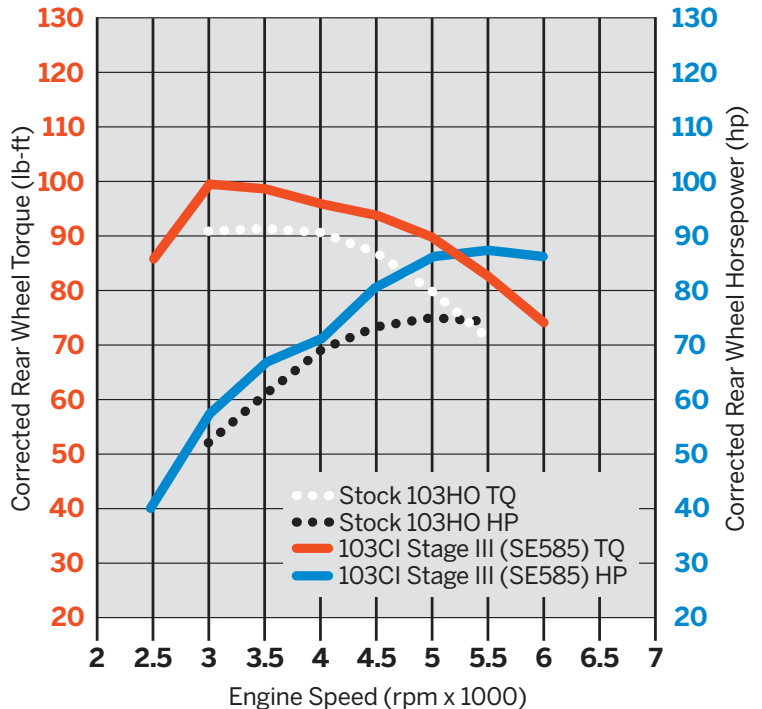

Street legal and/or street compliant statements refer to product meeting 50-State emissions and noise standards in the United States.

The street legal and/or street compliant statements may not apply to markets outside of the United States.

Notice: The prices appearing in this catalog are the manufacturer's suggested retail prices. Actual retail prices may vary.

STAGE III

SCREAMIN' EAGLE® 489

Twin Cam Stage III Upgrade

SCREAMIN' EAGLE® TWIN CAM STAGE III KIT – 103CI TO 110CI

Build a fast, reliable 110 cubic inch Twin Cam hauler without having to remove the motor from the chassis. This Stage III Street Performance Kit combines system-matched Screamin' Eagle® big bore cylinders, high compression pistons and performance cams and valve train components with the Original Equipment cylinder heads for a cost-effective boost in torque and performance. The exclusive bolt-on 4.0" cylinders are engineered with high strength slim-wall spigots that slip into the factory crank case without any additional machining. The 4" flat top pistons team with the stock cylinder heads to produce a performance-enhancing 10.2:1 compression ratio (10.4:1 on Twin-Cooled™ models), and the high-lift SE-585 cam produces a boost in torque throughout the RPM range. 50-State U.S. EPA compliant.

- Kit includes:
- Screamin' Eagle 4.0" Bolt-On Cylinders
- Forged 10.2:1 Compression Pistons and Rings
- SE-585 Cams
- High Performance Valve Springs
- Perfect-Fit Pushrods
- Screamin' Eagle High-Capacity Roller Tappets
- Top End and Cam Cover Gaskets
- Heavy Duty Clutch Spring

92500035 Black Highlighted. **\$1,849.95**

Fits '16-'17 Softail® and '14-'16 Touring models. Does not fit Trike models, FLSS, FLSTFBS, CVO™ 110 models or models with engine cases that have been machined to accept large-bore cylinders. Requires separate purchase of Cam Drive Retention Kit P/N 25566-06. Cam Spacer Kit P/N 25928-06 is recommended. Twin-Cooled models require separate purchase of model-specific head gaskets. All models require recalibration with Screamin' Eagle Pro Street Tuner (sold separately).

When installed by an authorized Harley-Davidson® Dealer within 60-days of the vehicle purchase, compliant kits do not impact the vehicle's limited warranty.



Twin Cam 103HO Stock vs. 103 to 110CI Stage III with SE CVO Mufflers

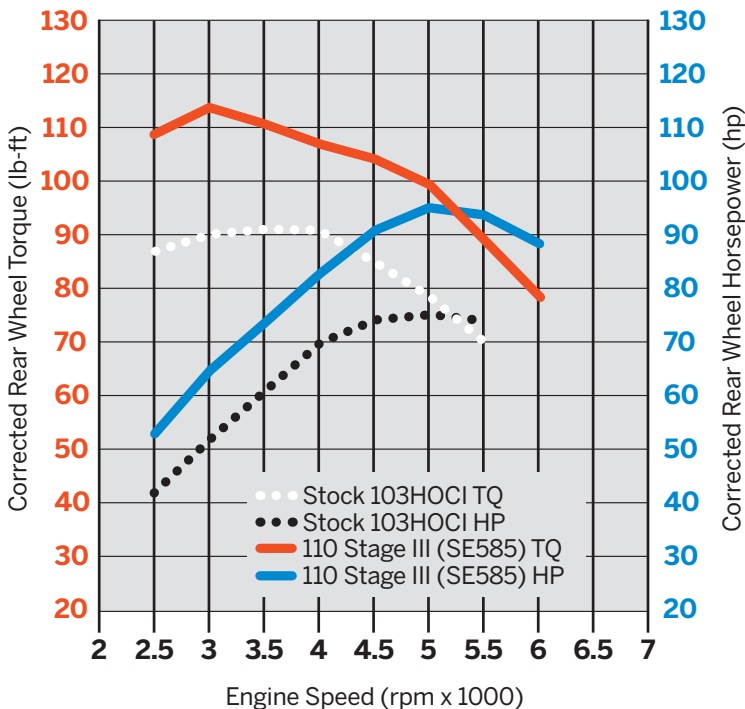

Street legal and/or street compliant statements refer to product meeting 50-State emissions and noise standards in the United States.

The street legal and/or street compliant statements may not apply to markets outside of the United States.

Notice: The prices appearing in this catalog are the manufacturer's suggested retail prices. Actual retail prices may vary.

490 SCREAMIN' EAGLE®

Twin Cam Stage III Upgrade

STAGE III

SCREAMIN' EAGLE® TWIN CAM CONVERSION KIT WITH CAMS – 96CI TO 103CI

The Stage II Big Bore Kit provides the parts you need to increase the horsepower of your EFI-equipped model. The kit increases the displacement of your Twin Cam-equipped model from 96 cubic inches (1584cc) to 103 cubic inches (1690cc). 50-State U.S. EPA compliant. California kits are street compliant on California pollution controlled vehicles when used with Original Equipment mufflers.

Kit includes:

- Big Bore Cylinders
- Big Bore Flat Top Pistons and Rings
- SE-255 Cams
- High-Flow Air Cleaner Kit with One-Piece Back Plate
- Top End Gasket Kit
- Heavy Duty Clutch Spring

27543-08 Black Highlighted. **\$949.95**

Fits '10-'11 Softail® models equipped with a Twin Cam 96™ engine. Also fits '08-'09 California Softail models. Installation requires separate purchase of Primary Cover Gasket. Cam Drive Retention Kit P/N 25566-06. Cam Spacer Kit P/N 25928-06 is recommended. All models require ECM calibration for proper installation. 

27557-08 Black Highlighted. **\$949.95**

Fits '10-'11 Touring models equipped with Twin Cam 96 engine. Also fits '08-'09 California Touring models. '10 FLHX and FLTRX models require separate purchase of 2-into-2 Head Pipe and mufflers. Installation requires separate purchase of Primary Cover Gasket. Cam Drive Retention Kit P/N 25566-06. Cam Spacer Kit P/N 25928-06 is recommended. All models require ECM calibration for proper installation. 

27564-09A Black Highlighted. **\$949.95**

Fits 49-state '09 Touring models. Kit includes catalyst head pipe. Does not fit Trike models. Not street compliant in California. Installation requires separate purchase of Primary Cover Gasket. Cam Drive Retention Kit P/N 25566-06. Cam Spacer Kit P/N 25928-06 is recommended. All models require ECM calibration for proper installation. 



NOTICE: Installation of automatic or manual compression releases on large displacement engines is highly recommended.

NOTICE: Installation of a California performance kit onto a 49-state model motorcycle or a 49-state performance kit onto a California model motorcycle will void manufacturers warranty, as it will not result in a street compliant configuration.

When installed by an authorized Harley-Davidson® Dealer within 60-days of the vehicle purchase, compliant kits do not impact the vehicle's limited warranty.

Twin Cam 96 Stock vs. 96 to 103CI Conversion with Street Use Exhaust

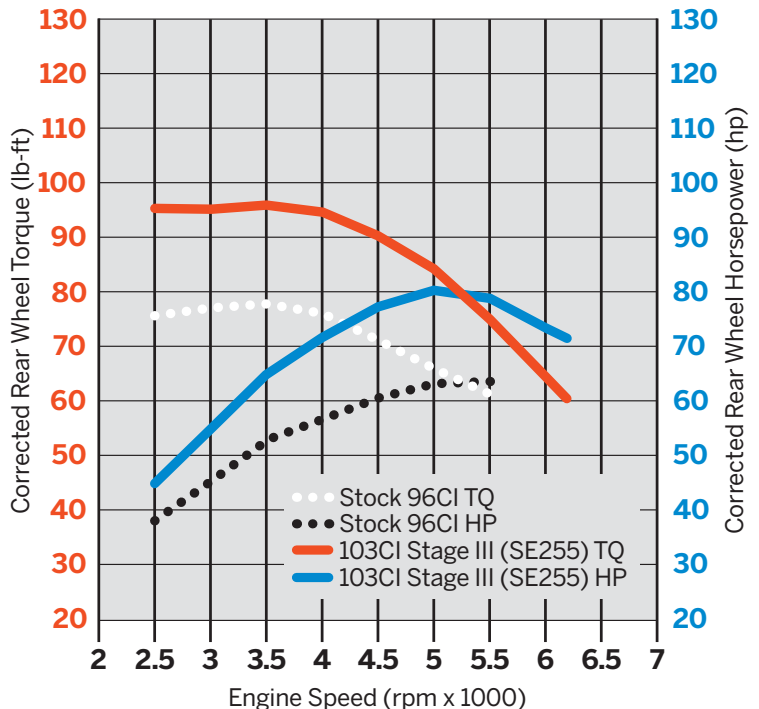

Street legal and/or street compliant statements refer to product meeting 50-State emissions and noise standards in the United States.

The street legal and/or street compliant statements may not apply to markets outside of the United States.

Notice: The prices appearing in this catalog are the manufacturer's suggested retail prices. Actual retail prices may vary.

STAGE III

SCREAMIN' EAGLE® 491

Twin Cam Stage III Upgrade

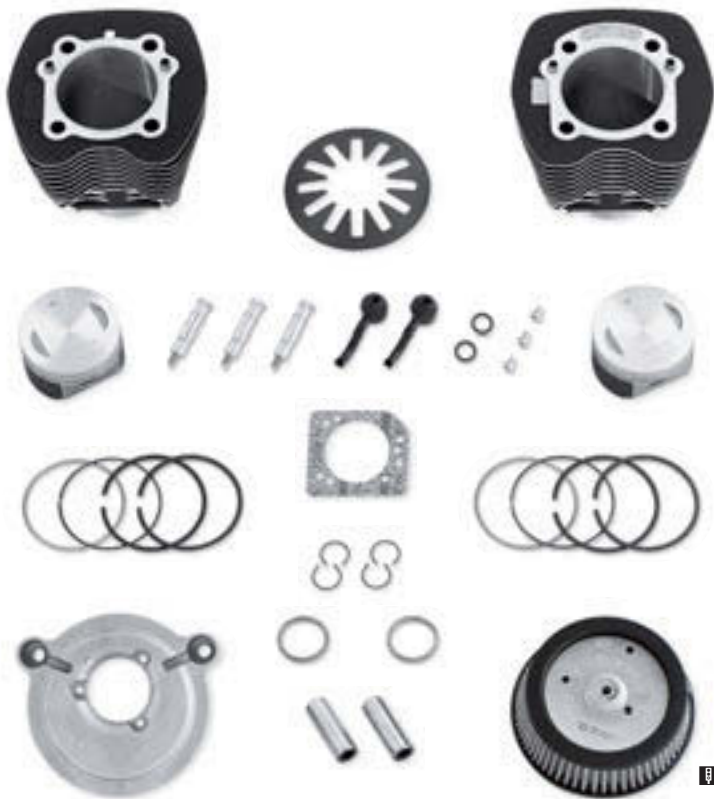

SCREAMIN' EAGLE® TWIN CAM CONVERSION KIT – 96CI TO 103CI

This Big Bore Kit lets you increase the displacement of your Twin Cam 96™ engine-equipped model from 96 cubic inches (1584cc) to 103 cubic inches (1690cc). A high-performance clutch spring is included to provide the additional clutch capacity required by the extra torque. 50-State U.S. EPA Compliant.

- Kit includes:
- Big Bore Cylinders
 - Big Bore Flat Top Pistons and Rings
 - High-Flow Air Cleaner with One-Piece Back Plate
 - Top End Gasket Kit
 - Heavy Duty Clutch Spring

29903-07A Black Highlighted. **\$699.95**

Fits all '07 Twin Cam and '08-'11 Softail® models equipped with a Twin Cam 96™ engine. Installation requires separate purchase of Primary Cover Gasket. Cam Drive Retention Kit P/N 25566-06. Cam Spacer Kit P/N 25928-06 is recommended. All models require ECM calibration for proper installation.

27539-08A Black Highlighted (not shown). **\$699.95**

Fits '08-'11 Touring models equipped with a Twin Cam 96 engine. Installation requires separate purchase of Primary Cover Gasket. Cam Drive Retention Kit P/N 25566-06. Cam Spacer Kit P/N 25928-06 is recommended. All models require ECM calibration for proper installation.

NOTICE: Installation of automatic or manual compression releases on large displacement engines is highly recommended.

When installed by an authorized Harley-Davidson® Dealer within 60-days of the vehicle purchase, compliant kits do not impact the vehicle's limited warranty.

Twin Cam 96 Stock vs. 96 to 103CI Conversion

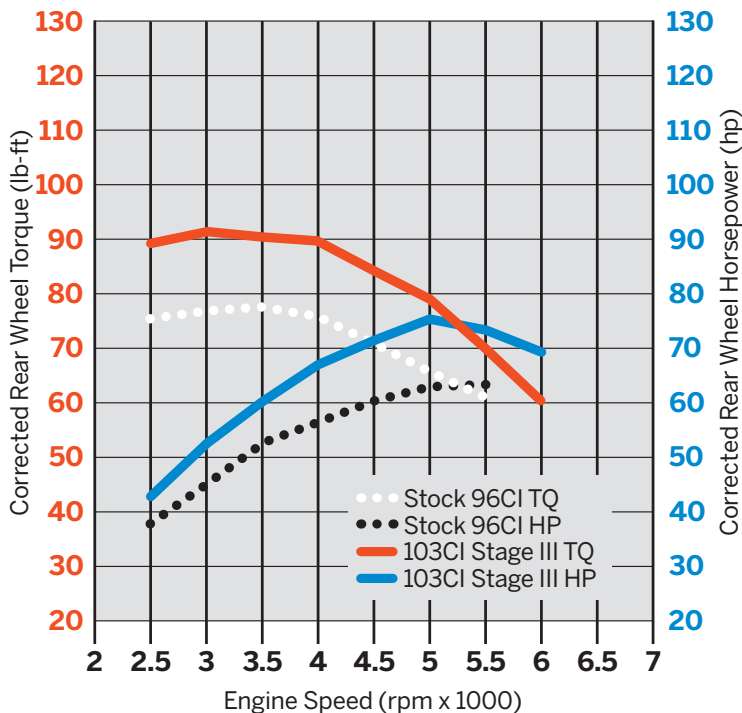

Street legal and/or street compliant statements refer to product meeting 50-State emissions and noise standards in the United States.

The street legal and/or street compliant statements may not apply to markets outside of the United States.

Notice: The prices appearing in this catalog are the manufacturer's suggested retail prices. Actual retail prices may vary.

492 SCREAMIN' EAGLE®

Twin Cam Stage IV Upgrade

STAGE IV

SCREAMIN' EAGLE® TWIN CAM TIRE SHREDDER KIT – 103CI TO 110CI

This comprehensive kit provides a complete package of matched components that allow you to build a high performance 110CI Twin Cam without voiding the factory warranty. The unique Screamin' Eagle® 4.0" big bore cylinders are engineered to slip into the engine cases without case machining or modification, so the engine stays in the chassis during the build. 50-State U.S. EPA compliant.

Kit includes:

- Screamin' Eagle 4.0" Bolt-On Cylinders
- Forged 10.2:1 High Compression Pistons and Rings
- Screamin' Eagle 58mm Throttle Body
- High Flow Fuel Injectors (5.3 g/s)
- Screamin' Eagle CNC-Ported Cylinder Heads
- SE-259E Cams
- Perfect-Fit Pushrods
- Screamin' Eagle High-Capacity Roller Tappets
- Top End and Cam Cover Gaskets
- Heavy Duty Clutch Spring

92500038

\$2,649.95

Fits '14-'16 Touring models. Does not fit Twin-Cooled™ models. Does not fit Trike models, CVO™ 110 models or models with engine cases that have been machined to accept large-bore cylinders. Requires separate purchase of accessory 58mm air cleaner and Cam Drive Retention Kit P/N 25566-06. Cam Spacer Kit P/N 25928-06 is recommended. All models require recalibration with Screamin' Eagle Pro Street Tuner (sold separately).

When installed by an authorized Harley-Davidson® Dealer within 60-days of the vehicle purchase, compliant kits do not impact the vehicle's limited warranty.



Twin Cam 103HO Stock vs. 103 to 110CI Tire Shredder Kit with Heavy Breather & Street Cannon Mufflers

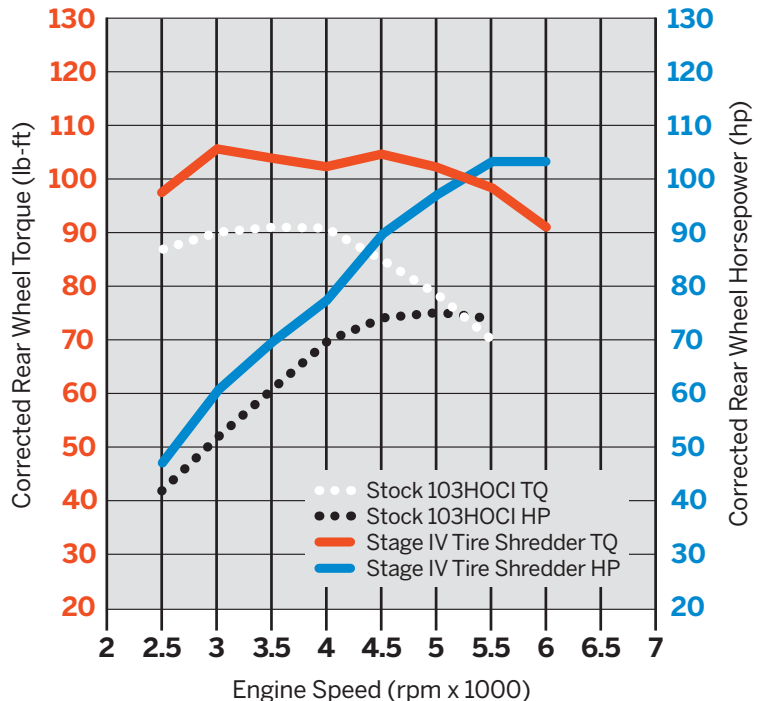

Street legal and/or street compliant statements refer to product meeting 50-State emissions and noise standards in the United States.

The street legal and/or street compliant statements may not apply to markets outside of the United States.

Notice: The prices appearing in this catalog are the manufacturer's suggested retail prices. Actual retail prices may vary.

STAGE IV

SCREAMIN' EAGLE® 493

Twin Cam Stage IV Upgrade

SCREAMIN' EAGLE® TWIN CAM CONVERSION KIT – 103CI TO 110CI

Bring your Twin Cam motorcycle up to the same 110 cubic inch displacement and power output as the CVO™ Screamin' Eagle® models without expensive machining or removing the engine from the chassis. This street compliant kit combines the proven SE-255 cams and cylinder heads of the CVO model with exclusive Screamin' Eagle bolt-on 4.0" cylinders and system-matched pistons to deliver high torque and reliable everyday performance. The automatic compression release-equipped cylinder heads and the flat top forged pistons combine to develop a 9.3:1 compression ratio for easy starting, and the Screamin' Eagle lifters ensure quiet reliable valve train operation. 50-State U.S. EPA compliant.

Kit includes:

- Screamin' Eagle 4.0" Bolt-On Cylinders
- Forged 9.3:1 Compression Pistons and Rings
- CVO 110 Cylinder Heads
- SE-255 Cams
- High-Capacity Roller Tappets
- Top End and Cam Cover Gaskets
- Heavy Duty Clutch Spring
- Cam Spacer Kit P/N 25928-06 is recommended

92500031 Black Highlighted. **\$2,299.95**

Fits '10-'16 Touring models (except '14-'16 models with Twin-Cooled™ engines). Does not fit Trike models, CVO 110 models, or models with engine cases that have been machined to accept large bore cylinders. Requires separate purchase of Screamin' Eagle high-flow air cleaner. '10 FLHX and FLTRX models require separate purchase of 2-into-2 Head Pipe Kit and Mufflers. '11-'16 Touring models require installation of CVO Mufflers P/N 64768-09A and 64769-09A or FatShotz Muffler Kit P/N 80847-10 (sold separately). '10-'11 Touring models require ACR Harness P/N 70623-08. Installation requires separate purchase of Primary Cover Gasket. Cam Drive Retention Kit P/N 25566-06. Cam Spacer Kit P/N 25928-06 is recommended. All models require ECM calibration for proper installation.

92500032 Black Highlighted. **\$2,395.95**

Fits '14-'16 FLHTCU, FLHTCUL, FLHTK, FLHTKL and FLTRU models with Twin-Cooled engines. Does not fit Trike models, CVO 110 models, or models with engine cases that have been machined to accept large bore cylinders. Requires separate purchase of Screamin' Eagle high-flow air cleaner. Installation requires separate purchase of Primary Cover Gasket. Cam Drive Retention Kit P/N 25566-06. Cam Spacer Kit P/N 25928-06 is recommended. All models require ECM calibration for proper installation.

92500033 Black Highlighted. **\$2,299.95**

Fits '11-'17 Dyna® FXD, FXDB and FXDC models equipped with Shorty Dual Exhaust. Installation requires separate purchase of Muffler P/N 64895-09 (Qty 2). Also fits 50-state '10-'17 FXDF and FXDWG models. FXDF and FXDWG models requires separate purchase of Mufflers P/N 65884-09 and 65886-09. All Dyna models require separate purchase of Screamin' Eagle high flow cleaner. '10-'11 Dyna models require ACR Harness P/N 70623-06. Does not fit models with engine cases that have been machined to accept large-bore cylinders. Also fits 50-state '11-'17 Softail® models (except FLS, FLSS, FLSTFBS, FLSTN, FLSTSB, CVO 110 models or models with engine cases that have been machined to accept large-bore cylinders.). Requires separate purchase of Screamin' Eagle high flow air cleaner. '11 Softail models require ACR Harness P/N 70623-11. Installation requires separate purchase of Primary Cover Gasket. Cam Drive Retention Kit P/N 25566-06. Cam Spacer Kit P/N 25928-06 is recommended. All models require ECM calibration for proper installation. '17 models require recalibration with Screamin' Eagle Pro Street Tuner (sold separately).

When installed by an authorized Harley-Davidson® Dealer within 60-days of the vehicle purchase, compliant kits do not impact the vehicle's limited warranty.

Street legal and/or street compliant statements refer to product meeting 50-State emissions and noise standards in the United States.

The street legal and/or street compliant statements may not apply to markets outside of the United States.

Notice: The prices appearing in this catalog are the manufacturer's suggested retail prices. Actual retail prices may vary.

SCREAMIN' EAGLE



Twin Cam 103HO Stock vs. 103 to 110CI Stage IV Conversion Kit

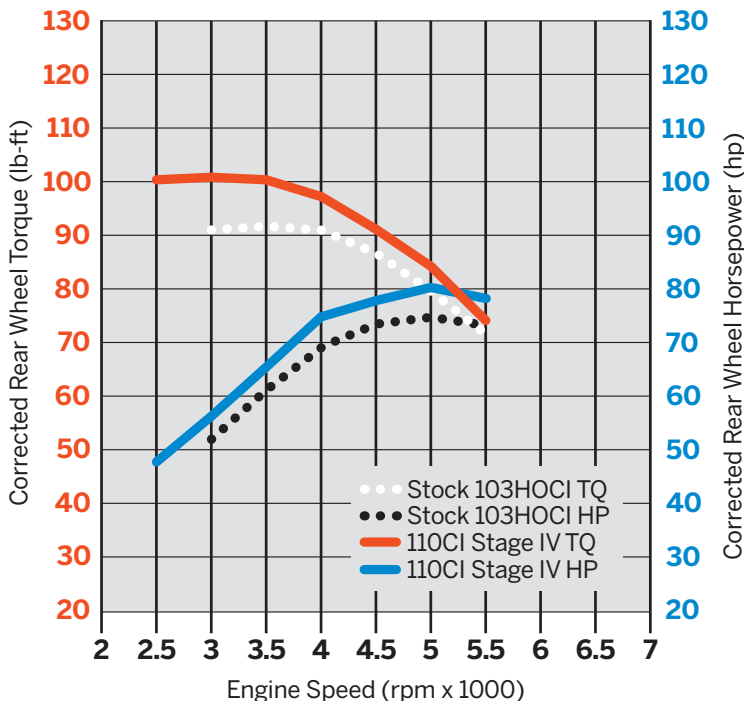

494 SCREAMIN' EAGLE®

Twin Cam Stage IV Upgrade

STAGE IV

SCREAMIN' EAGLE® TWIN CAM STAGE IV KIT – 103CI TO 103CI

This Street Performance kit provides the maximum horsepower output for a legal 103 Kit that will maintain the factory warranty. The Air Cooled Street Performance Kit Produces 96 hp and 105 lbs-ft of torque. The Twin-Cooled™ engine version is rated at 93 hp and 100 lbs-ft of torque. 50-State U.S. EPA compliant.

Kit includes:

- Forged 10.5:1 High Compression Pistons and Rings
- Screamin' Eagle® 58mm Throttle Body
- Screamin' Eagle CNC Ported Cylinder Heads
- SE-259E Cams
- Perfect-Fit Pushrods
- Top End Gasket Kit
- Heavy Duty Clutch Spring

92500011 Black Highlighted. **\$1,995.95**

Fits '16-'17 Softail® (except FLSS, FLSTFBS and FXSE) and '10-'16 Touring models (except '14-'16 models with Twin-Cooled engines) equipped with a Twin Cam 103™ engine. Fits 49-state '10-'11 Touring models equipped with a Twin Cam 96™ engine with separate purchase of Screamin' Eagle 3-7/8" Big Bore Cylinder Kit. '10 FLHX and FLTRX requires dual exhaust. Does not fit Trike models. Installation requires separate purchase of Primary Cover Gasket. Cam Drive Retention Kit P/N 25566-06. Cam Spacer Kit P/N 25928-06 is recommended. All models require ECM calibration for proper installation. '17 models require recalibration with Screamin' Eagle Pro Street Tuner (sold separately).

92500019 Black Highlighted. **\$1,995.95**

Fits '14-'16 FLHTCU, FLHTCUL, FLHTK and FLHTKL models with Twin-Cooled engines. Does not fit Trike models. Installation requires separate purchase of Primary Cover Gasket. Cam Drive Retention Kit P/N 25566-06. Cam Spacer Kit P/N 25928-06 is recommended. All models require ECM calibration for proper installation.



When installed by an authorized Harley-Davidson® Dealer within 60-days of the vehicle purchase, compliant kits do not impact the vehicle's limited warranty.

Air Cooled
Twin Cam 103HO Stock vs. 103CI Stage IV with Heavy Breather & Street Cannon Mufflers

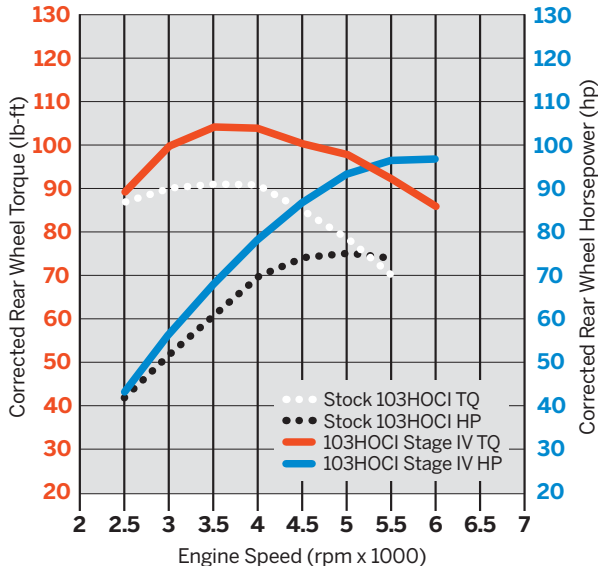

Twin-Cooled™
Twin Cam 103HO Stock vs. 103CI Stage IV with Heavy Breather & Street Cannon Mufflers

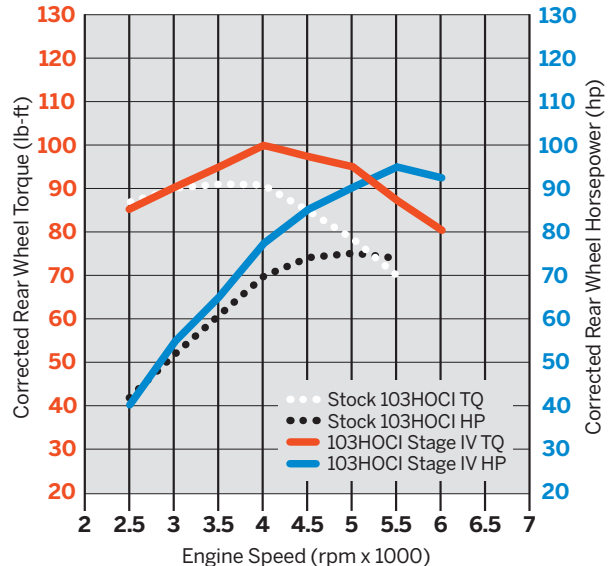

Street legal and/or street compliant statements refer to product meeting 50-State emissions and noise standards in the United States.

The street legal and/or street compliant statements may not apply to markets outside of the United States.

Notice: The prices appearing in this catalog are the manufacturer's suggested retail prices. Actual retail prices may vary.

STAGE IV

SCREAMIN' EAGLE® 495

Twin Cam Stage IV Upgrade

SCREAMIN' EAGLE® TWIN CAM BOLT-ON 110CI TO 117CI KIT

Turn your Original Equipment 110 cubic inch model into a fast, reliable 117 cubic inch Twin Cam hauler without having to remove the motor from the chassis. This Street Performance Kit combines system-matched Screamin' Eagle® big bore cylinders, forged pistons and performance cams and valve train components with the Original Equipment cylinder heads for a cost-effective boost in torque and performance. The exclusive bolt-on 4.125" cylinders are engineered with high strength slim-wall spigots that slip into the factory 110CI crank case without any additional machining. The 4.125" flat top pistons team with the stock cylinder heads to produce a performance-enhancing 9.9:1 compression ratio, and the high-lift SE-259E cam produces a boost in torque throughout the RPM range. 50-State U.S. EPA compliant.

Kit includes:

- Screamin' Eagle 4.125" Bolt-On Cylinders
- Forged 9.9:1 Compression Pistons and Rings
- Screamin' Eagle 58mm Throttle Body
- High Flow Fuel Injectors (5.3 g/s)
- SE-259E Cams
- Perfect-Fit Pushrods
- Screamin' Eagle High-Capacity Roller Tappets
- Screamin' Eagle Inner Cam Bearing Kit
- Top End and Cam Cover Gaskets

Fits '14-'17 CVO™ 110CI Softail® and '14-'16 CVO Touring models. Also fits '16-'17 110CI FLSS, FLSTFBS and FXDLS models. Requires purchase of accessory 58mm air cleaner and Cam Drive Retention Kit P/N 25566-06 (except models equipped with Screamin' Eagle Heavy Breather Elite Performance Air Cleaner Kits). Models equipped with Ventilator Air Cleaner require separate purchase of 58mm Air Cleaner Backplate P/N 29400038. All models require ECM calibration for proper installation. '16-'17 FXDLS and all '17 models require recalibration with Screamin' Eagle Pro Street Tuner (sold separately).

92500055	Granite Finish.	\$2,095.95
92500054	Black Finish.	\$2,095.95

When installed by an authorized Harley-Davidson® Dealer within 60-days of the vehicle purchase, compliant kits do not impact the vehicle's limited warranty.



Twin Cam CVO™ 110CI Stock vs 110 to 117CI Stage IV with Ventilator Air Cleaner & SE CVO Mufflers

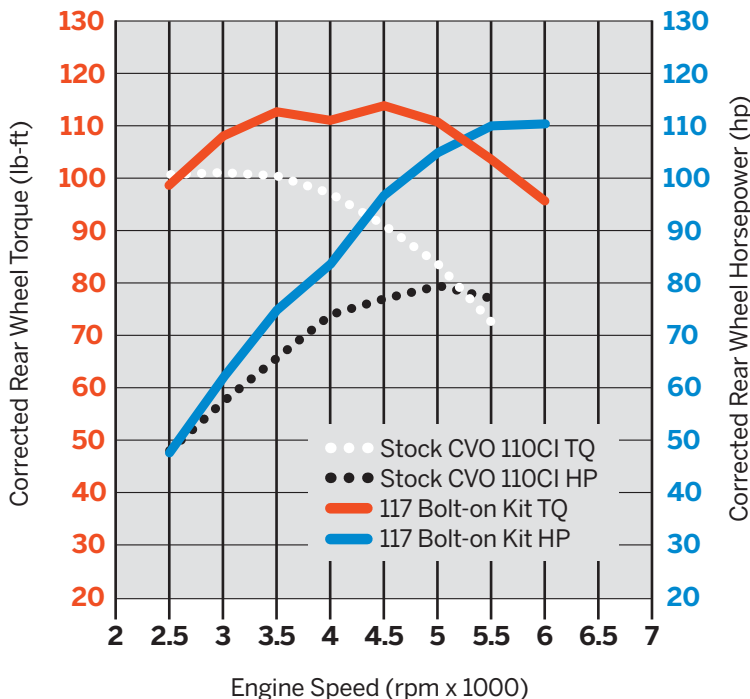

Street legal and/or street compliant statements refer to product meeting 50-State emissions and noise standards in the United States.

The street legal and/or street compliant statements may not apply to markets outside of the United States.

Notice: The prices appearing in this catalog are the manufacturer's suggested retail prices. Actual retail prices may vary.

SCREAMIN' EAGLE

496 SCREAMIN' EAGLE®

Sportster® Stage Upgrades

SPORTSTER® POWERTRAIN

Screamin' Eagle® Stage upgrades offer complete street-compliant performance configurations engineered to generate specific torque and horsepower gains. Eliminating all the guesswork and trial-and-error testing normally associated with engine modifications, Stage upgrades include everything you need to enhance your bike's performance.



STAGE I

INTAKE + EXHAUST + TUNING

The easiest and most cost effective step to improve your motorcycle's performance is to increase the air flow into and out of the engine. A high-flow air cleaner and system-matched slip-on mufflers provide horsepower and torque improvements you can feel throughout the RPM range, and serve as the core components for all performance upgrades. ECM calibration is required to tune the fuel flow and timing required to accommodate the improved air flow.

Stage I upgrade can be installed without engine disassembly. No special tools are required. Requires ECM tuning.



Street legal and/or street compliant statements refer to product meeting 50-State emissions and noise standards in the United States.

The street legal and/or street compliant statements may not apply to markets outside of the United States.

Sportster 1200 Stock vs. 1200 Stage I*

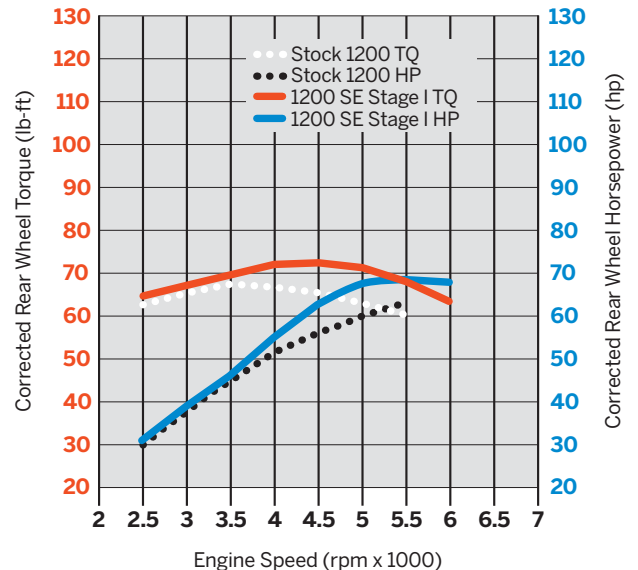

*14-later XL1200 Stage II with Heavy Breather A/C & Street Cannon Mufflers

STAGE II

STAGE I + CAM UPGRADE

Adding performance cams to a Stage I equipped bike is the next step to improved performance. Cam choices allow you to tailor the engine's performance to your specific needs. A torque cam offers on-demand throttle response from low- to mid-RPM at cruising speed. A power cam targets high-rpm, wide-open throttle response that keeps pulling right up to redline. ECM calibration tuning is required to accommodate the increased valve timing, and performance valve springs may be required for high-lift cams.

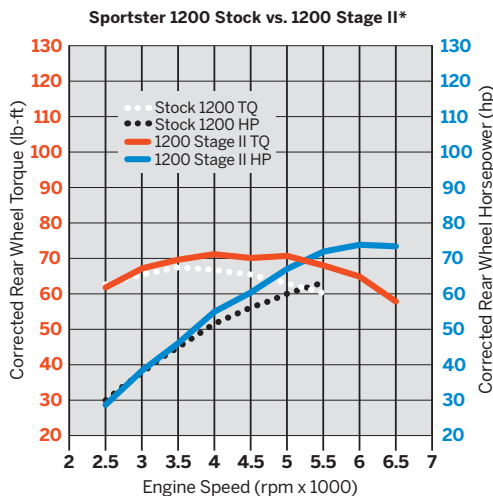

*14-later XL1200 Stage II with Heavy Breather A/C & Street Cannon Mufflers



Stage II upgrade requires minor engine disassembly to replace the cam. Special tools and ECM tuning are required.



STAGE IV

STAGE I + CAMS, PISTONS, CYLINDER HEADS & THROTTLE BODY

For maximum performance improvement, the addition of high-compression pistons, free-flowing ported cylinder heads and a big bore throttle body top off a performance build. The large diameter throttle body and port-matched intake manifold deliver huge volumes of fuel and air to the engine, the smooth passages and larger valves easily dump the mixture into the engine, and the high compression pistons squeeze the air/fuel into a more volatile vapor. When ignited, the result is a major power increase. Designed to satisfy the high RPM, throttle twisting rider, the Stage IV update delivers 20-30% increase in power that keeps pulling right up to the redline, without sacrificing mid-range torque. ECM calibration tuning is required to add more fuel, and a higher-lift cam may be required to deliver maximum power.

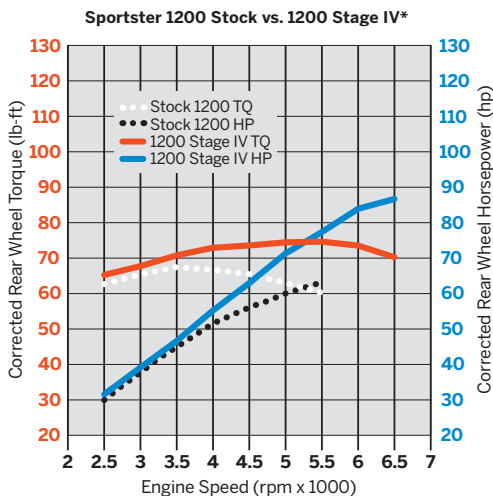

*1200 Stage IV with High-Flow A/C & Street Cannon Mufflers



Stage IV bolt-on upgrade requires removal of the engine's top-end and opening the cam chest. Engine remains in the chassis and no machining is required. Special tools and ECM tuning are required.



Street legal and/or street compliant statements refer to product meeting 50-State emissions and noise standards in the United States.

The street legal and/or street compliant statements may not apply to markets outside of the United States.

498 SCREAMIN' EAGLE®

Sportster® Stage I Upgrade

A. SCREAMIN' EAGLE® HEAVY BREATHER PERFORMANCE AIR CLEANER KIT

This high-flow forward-facing exposed element Air Cleaner Kit is sure to turn heads at the starting line. Featuring a polished elbow and exposed filter, this unique air cleaner system offers improved performance and airflow when compared to the stock or Screamin' Eagle® High-Flow Air Cleaner. The washable and rechargeable filter features a bright chrome end cap with a laser-engraved Screamin' Eagle logo. Intake tube and back plate are made from die-cast lightweight aluminum and are polished and chrome-plated or painted black for a brilliant finish. The back plate features integral breathers and sealed breather bolt plug. Kit includes a water-repellent rain sock and all mounting hardware. 50-State U.S. EPA compliant.

Fits '08-later XL models with Original Equipment Throttle Body. All models require ECM calibration for proper installation. '17-later models require recalibration with Screamin' Eagle Pro Street Tuner (sold separately).

29264-08A	Chrome.	\$329.95
29080-09A	Gloss Black.	\$329.95

Fits '14-later XL1200 model equipped with Screamin' Eagle High Flow 58mm Throttle Body. All models require ECM calibration for proper installation. '17-later models require recalibration with Screamin' Eagle Pro Street Tuner (sold separately).

29400228	Chrome.	\$349.95
29400227A	Gloss Black.	\$349.95

NOTE: The washable and rechargeable filter uses a special coating to help filter fine particles from the incoming air. With time, the oil in the filter will dissipate and the element will begin to turn gray. The original red color can be restored with an application of K&N® Air Filter Oil.

B. SCREAMIN' EAGLE HEAVY BREATHER FILTER COVER – TEARDROP

Dress up the Heavy Breather Air Cleaner with this radical cover. Manufactured from forged aluminum and precision CNC-machined and polished, these easy-to-install two-piece covers add a rich custom look. Cover is available in mirror-chrome or cut back gloss black finish to match your customizing direction. Kit includes water-repellent rain sock.

Fits models equipped with Screamin' Eagle Heavy Breather Air Cleaner Kits (except Compact Heavy Breather P/N 28716-10A, Heavy Breather Elite P/N 29400173, 29400172 or 29400285, and Milwaukee-Eight® Heavy Breather P/N 29400263 or 29400264).

29400061A	Cut Back Gloss Black – Side Logo.	\$174.95
28739-10A	Cut Back Gloss Black – End Logo.	\$169.95
28740-10A	Chrome – End Logo.	\$174.95



A. SCREAMIN' EAGLE HEAVY BREATHER PERFORMANCE AIR CLEANER KIT – CHROME



A. SCREAMIN' EAGLE HEAVY BREATHER PERFORMANCE AIR CLEANER KIT – GLOSS BLACK



B. SCREAMIN' EAGLE HEAVY BREATHER FILTER COVER – TEARDROP, CUT BACK GLOSS BLACK – SIDE LOGO



B. SCREAMIN' EAGLE HEAVY BREATHER FILTER COVER – TEARDROP, CHROME



B. SCREAMIN' EAGLE HEAVY BREATHER FILTER COVER – TEARDROP, CUT BACK GLOSS BLACK

Street legal and/or street compliant statements refer to product meeting 50-State emissions and noise standards in the United States.

The street legal and/or street compliant statements may not apply to markets outside of the United States.

Notice: The prices appearing in this catalog are the manufacturer's suggested retail prices. Actual retail prices may vary.



C. SCREAMIN' EAGLE PERFORMANCE AIR CLEANER KIT – RAIL COLLECTION

SCREAMIN' EAGLE® 499

Sportster® Stage I Upgrade

C. SCREAMIN' EAGLE® PERFORMANCE AIR CLEANER KIT – RAIL COLLECTION

The look is bold and the performance exhilarating. This race-inspired air cleaner is engineered to flow through the perimeter and the face of the air filter, providing high volumes of unrestricted airflow to the engine. The open-design face plate features a rich black finish with machined longitudinal strakes to expose the glowing aluminum below. Kit includes air cleaner trim, one-piece cast back plate, high-flow washable air filter element, rain sock and all required hardware. 50-State U.S. EPA compliant.

29400232A **\$299.95**

Fits '07-later XL models with Original Equipment throttle body. All models require ECM calibration for proper installation. '17-later models require recalibration with Screamin' Eagle® Pro Street Tuner (sold separately).

D. SCREAMIN' EAGLE EXTREME BILLET AIR CLEANER KIT

The bold styling of this intake system looks just as impressive as the long patch of burnout rubber you just laid down. The forged billet aluminum cover tops off a cast back plate with integral breather for a smooth transition to the throttle body. The race-inspired air cleaner is engineered to flow high volumes of air and the washable pleated element provides the ideal combination of efficiency and engine protection. Available in your choice of style and finish, this easy-to-install kit includes all mounting hardware and rain sock. 50-State U.S. EPA compliant.

Fits '07-later XL models with Original Equipment throttle body. All models require ECM calibration for proper installation. '17-later models require recalibration with Screamin' Eagle Pro Street Tuner (sold separately).

29400128 Chisel – Chrome. **\$349.95**

29400127 Chisel – Cut Back Gloss Black. **\$349.95**

NOTE: The washable and rechargeable filter uses a special coating to help filter fine particles from the incoming air. With time, the oil in the filter will dissipate and the element will begin to turn gray. The original red color can be restored with an application of K&N® Air Filter Oil.



D. EXTREME BILLET AIR CLEANER KIT – CHISEL, CHROME



D. EXTREME BILLET AIR CLEANER KIT – CHISEL, CUT BACK GLOSS BLACK

SCREAMIN' EAGLE

Street legal and/or street compliant statements refer to product meeting 50-State emissions and noise standards in the United States.

The street legal and/or street compliant statements may not apply to markets outside of the United States.

Notice: The prices appearing in this catalog are the manufacturer's suggested retail prices. Actual retail prices may vary.

500 SCREAMIN' EAGLE®

Sportster® Stage I Upgrade

A. SCREAMIN' EAGLE® OVAL HIGH-FLOW AIR CLEANER

The XL High-Flow Air Cleaner Kit provides increased airflow to boost the power of your fuel-injected Sportster® model. The complete kit features a composite air cleaner back plate, air cleaner cover adapter, a high-flow washable synthetic media filter element that does not require oiling and a breather system that routes gasses and excess oil directly into the intake. Kit also includes cover trim and all mounting hardware. Street compliant when used with stock mufflers. 50-State U.S. EPA compliant.

29782-07 **\$154.95**

Fits '07-later XL models with Original Equipment throttle body and oval air cleaner cover. All models require ECM calibration for proper installation. '17-later models require recalibration with Screamin' Eagle® Pro Street Tuner (sold separately).



A. SCREAMIN' EAGLE OVAL HIGH-FLOW AIR CLEANER

B. SCREAMIN' EAGLE ROUND HIGH-FLOW AIR CLEANER

The XL High-Flow Air Cleaner Kit provides increased airflow to boost the power of your fuel-injected Sportster model. Available with brilliant chrome or gloss black back plate, this Round Air Cleaner transforms the appearance of your Evolution power plant and allows you to replace the Original Equipment oval air cleaner cover with your choice of accessory round covers. Or choose to flaunt your performance gains with the open element look, finished with custom Air Cleaner Trim from one of the Harley-Davidson® decorative collections. Kit includes one-piece cast back plate, high-flow washable air filter element and all required hardware. Street compliant when used with stock mufflers. 50-State U.S. EPA compliant.

Fits '07-later XL models with Original Equipment throttle body and round air cleaner cover or round air cleaner Trim. Proper installation with round air cleaner cover requires separate purchase of Air Cleaner Filter Gasket P/N 25700127. All models require ECM calibration for proper installation. '17-later models require recalibration with Screamin' Eagle Pro Street Tuner (sold separately).

29000019A Chrome. **\$149.95**

29000009A Black. **\$149.95**



B. SCREAMIN' EAGLE ROUND HIGH-FLOW AIR CLEANER

C. SCREAMIN' EAGLE AIR CLEANER RAIN SOCK

Add the open-element look to your Screamin' Eagle High-Flow style Air Cleaner. This easy-to-install kit allows you to replace the traditional Original Equipment air cleaner cover with custom inserts from one of the H-D® Decorative Collections. Kit includes a breathable mesh cover with classic Bar & Shield logo that stretches over the filter to maximize airflow while protecting the exposed element from the rain. Fits traditional cone-shaped air cleaner elements featured in many Screamin' Eagle Twin Cam Stage Kits.

28728-10 **\$25.95**

Fits Screamin' Eagle Round High-Flow Air Cleaner Kits.



C. SCREAMIN' EAGLE AIR CLEANER RAIN SOCK (SHOWN WITH #1 SKULL AIR CLEANER TRIM)

Street legal and/or street compliant statements refer to product meeting 50-State emissions and noise standards in the United States.

The street legal and/or street compliant statements may not apply to markets outside of the United States.

Notice: The prices appearing in this catalog are the manufacturer's suggested retail prices. Actual retail prices may vary.

SCREAMIN' EAGLE® 501

Sportster® Stage I Upgrade



D. SCREAMIN' EAGLE STREET CANNON SLIP-ON MUFFLERS – SPORTSTER SHORTY DUAL, CHROME
(SHOWN WITH CHROME SLASH END CAPS AND BUCKSHOT EXHAUST SHIELDS)



D. SCREAMIN' EAGLE STREET CANNON SLIP-ON MUFFLERS – SPORTSTER SHORTY DUAL, JET BLACK
(SHOWN WITH JET BLACK SLASH END CAPS AND BUCKSHOT EXHAUST SHIELDS)



E. SCREAMIN' EAGLE STREET PERFORMANCE SLIP-ON SHORTY DUAL MUFFLERS – CHROME



E. SCREAMIN' EAGLE STREET PERFORMANCE SLIP-ON SHORTY DUAL MUFFLERS – JET BLACK
(SHOWN WITH JET BLACK BUCKSHOT EXHAUST SHIELDS)

D. SCREAMIN' EAGLE® STREET CANNON SLIP-ON MUFFLERS – SPORTSTER® SHORTY DUAL

These 3.25" street compliant high-flow mufflers have been specifically tuned to deliver an aggressive exhaust note and improved performance while preserving the peace with your neighbors. Available in your choice of rich chrome or heat resistant jet black ceramic finish. Complete the look with your choice of 3.25" endcaps and Screamin' Eagle® Muffler shields (sold separately).

Fits '14-later XL models. Installation requires separate purchase of 3.25" End Caps and Muffler Clamps P/N 65296-95A (Qty 2). All models require ECM calibration for proper installation. '17-later models require recalibration with Screamin' Eagle Pro Street Tuner (sold separately). 50-State U.S. EPA compliant.

64900208A	Chrome.	\$419.95
64900209A	Jet Black.	\$459.95

Fits '17-later XL1200 models. Designed for International markets that require ECE certified mufflers. Mufflers include matching slash down end caps. Installation requires separate purchase of Muffler Clamps P/N 65296-95A (Qty 2).

64900477	Chrome.	\$674.95
64900476	Jet Black.	\$794.95

E. SCREAMIN' EAGLE STREET PERFORMANCE SLIP-ON MUFFLERS – SPORTSTER SHORTY DUAL

Street compliant high-flow mufflers are factory tuned to deliver an aggressive exhaust note and improved performance comparable to Screamin' Eagle II mufflers. Available in your choice of rich chrome or heat-resistant jet black ceramic finish, these mufflers feature a deep embossed Screamin' Eagle logo along the flank. 50-State U.S. EPA compliant.

Fits '07-'13 XL models. Installation requires separate purchase of Muffler Clamps P/N 65296-95A (Qty 2).

80503-07	Chrome.	\$299.95
80726-09A	Jet Black.	\$399.95

NOTE: Due to increased diameter of these mufflers some realignment of head pipes is usually required. It is recommended to replace exhaust port gaskets, P/N 65324-83A (stock) or P/N 17048-98 (performance), to avoid tendency of head pipes to return to original position when re-tightened.

NOTE: There is no warranty on exhaust pipes and mufflers with regard to any discoloration. Blueing is caused by tuning characteristics, cam timing, carburetor jetting, over-heating, etc. and is not caused by defective manufacturing.

Street legal and/or street compliant statements refer to product meeting 50-State emissions and noise standards in the United States.

The street legal and/or street compliant statements may not apply to markets outside of the United States.

Notice: The prices appearing in this catalog are the manufacturer's suggested retail prices. Actual retail prices may vary.

502 SCREAMIN' EAGLE®

Sportster® Stage I Upgrade

A. BRONZE MUFFLER END CAPS – 3.25"

These easy-to-install end caps allow you to finish your 3.25" Screamin' Eagle® mufflers your way. The durable bronze tone ceramic coated finish is the ideal complement to black coated mufflers, and sets your ride apart from the crowd. Sold in pairs. Installation hardware included.

65100107 **\$129.95**
Fits '14-later XL and '07-'17 Softail® models equipped with Screamin' Eagle 3.25" Street Cannon Mufflers.



A. BRONZE MUFFLER END CAPS – 3.25"

B. MUFFLER END CAPS – 3.25"

These easy-to-install caps allow you to finish your 3.25" Screamin' Eagle mufflers your way. Sold in pairs. Installation hardware included.

Fits '14-later XL and '07-'17 Softail models equipped with Screamin' Eagle 3.25" Street Cannon Mufflers.

65100048A	Satin Black Anodized.	\$119.95
65100049	Billet Chrome Slash Cut.	\$119.95
65100044	Chrome – Slash Up/Down/Out.	\$99.95
65100063	Jet Black – Slash Up/Down/Out.	\$109.95



B. MUFFLER END CAPS – 3.25"
(SATIN BLACK ANODIZED SHOWN)

C. JET BLACK HEADER PIPES

Hide the blue. These Original Equipment-style Header Pipes have been finished with a unique jet black heat resistant coating and are a great accent to both chrome and black Buckshot exhaust shields. When exposed through the holes in the Buckshot shields, the black header pipe provides a sinister accent and hides the heat-tempered finish of the typical exhaust pipe. Easy-to-install using factory mounting hardware, the kit includes front and rear header pipe.

65600155 **\$199.95**
Fits '14-later XL models.



B. MUFFLER END CAPS – 3.25"

D. SCREAMIN' EAGLE® SLASH CUT MUFFLER SHIELDS – SATIN BLACK

Shaped to mirror the slash down profile of available muffer end caps, this set of rich satin black Muffer Shields is the perfect complement to your blacked-out exhaust system. The rear shield features a subtle laser-etched Screamin' Eagle script. Easy-to-install kit includes front and rear shields and black mounting hardware.

65400405 **\$129.95**
Fits '07-later XL, '07-'17 Dyna® (except '08-'17 FLD, FXDF, FXDL, FXDLS and '10-'17 FXDWG) and '07-'17 Softail® models equipped with Screamin' Eagle Street Performance mufflers.

E. SCREAMIN' EAGLE SLASH CUT MUFFLER SHIELDS – CHROME

Styled to complement the ballistic inlet shape of the Screamin' Eagle Street Performance Slip-On Mufflers. The slash-cut rear shield features a laser-etched Screamin' Eagle signature script. Easy-to-install kit includes front and rear shields and mounting hardware.

65400464 **\$69.95**
Fits '07-later XL, '07-'17 Dyna® (except '08-'17 FLD, FXDF, FXDL, FXDLS and '10-'17 FXDWG) and '07-'17 Softail models equipped with Screamin' Eagle Street Performance Mufflers.



C. JET BLACK HEADER PIPES



D. SCREAMIN' EAGLE SLASH CUT MUFFLER SHIELDS – SATIN BLACK



E. SCREAMIN' EAGLE SLASH CUT MUFFLER SHIELDS – CHROME

Street legal and/or street compliant statements refer to product meeting 50-State emissions and noise standards in the United States.

The street legal and/or street compliant statements may not apply to markets outside of the United States.

Notice: The prices appearing in this catalog are the manufacturer's suggested retail prices. Actual retail prices may vary.

SCREAMIN' EAGLE® 503

Sportster® Stage I Upgrade



F. SLOTTED EXHAUST SHIELD KIT – BRONZE



F. SLOTTED EXHAUST SHIELD KIT

Add a custom touch to your ride. These formed steel exhaust shields are available in tough heat-resistant satin black or bronze finishes that look just right when paired with black Screamin' Eagle® Street Cannon Slip-On Mufflers. The slotted cutouts are backed with textured stainless inserts to provide a raw, hand-crafted look. Manufactured to Original Equipment standards for exact fit, these easy-to-install kits include front and rear head pipe shields.

Fits '14-later XL models.

65400404 Bronze. **\$199.95**

65400422 Satin Black. **\$199.95**

G. BUCKSHOT EXHAUST SHIELD KIT

These custom shields feature a perforated "Buckshot" design that exposes the head pipe for a raw, rebellious look. Available in your choice of finishes, these exhaust shields are a perfect match for Original Equipment or Screamin' Eagle mufflers and provide a consistent look from front to back. Manufactured to Original Equipment standards for exacting fit, the easy-to-install kit includes front and rear head pipe shields.

Fits '14-later XL models.

65400137A Jet Black. **\$159.95**

65400143 Chrome. **\$159.95**

Fits '04-'13 XL models.

64924-09 Jet Black. **\$159.95**

H. SCREAMIN' EAGLE® MUFFLER SHIELDS

Styled to complement the ballistic inlet shape of the Screamin' Eagle Street Performance Slip-On Mufflers. The rear shield features a deep embossed Screamin' Eagle signature script. Available in chrome and jet black. Easy-to-install kit includes front and rear shields and mounting hardware.

Fits '07-later XL, '07-'17 Dyna® (except '08-'17 FLD, FXDF, FXDL and '10-later FXDWG) and '07-'17 Softail® models equipped with Screamin' Eagle Street Performance Mufflers.

64806-07A Chrome. **\$59.95**

65400078 Jet Black. **\$129.95**



F. SLOTTED EXHAUST SHIELD KIT – SATIN BLACK



G. BUCKSHOT EXHAUST SHIELD KIT – JET BLACK
(65400137A SHOWN)



G. BUCKSHOT EXHAUST SHIELD KIT – CHROME
(65400143 SHOWN)



G. BUCKSHOT EXHAUST SHIELD KIT – JET BLACK
(64924-09 SHOWN)



H. SCREAMIN' EAGLE MUFFLER SHIELDS

SCREAMIN' EAGLE

Street legal and/or street compliant statements refer to product meeting 50-State emissions and noise standards in the United States.

The street legal and/or street compliant statements may not apply to markets outside of the United States.

Notice: The prices appearing in this catalog are the manufacturer's suggested retail prices. Actual retail prices may vary.

504 SCREAMIN' EAGLE®

Sportster® Stage II Upgrade

A. SCREAMIN' EAGLE® PERFORMANCE II SE-585 CAM KIT- SPORTSTER®

The high-lift full throttle cam kit provides significant horsepower gains when coupled with high-flowing exhaust and intake components, and is a great fit for full-throttle horsepower junkies. 50-State U.S. EPA compliant.

25400125 **\$349.95**

Fits '14-later XL1200 models. Requires installation of Performance Cylinder Heads P/N 16500074 or 16500347, or upgrade of Original Equipment heads with Performance Valve Spring Kit P/N 18013-03A. All models require ECM calibration for proper installation. '17-later models require recalibration with Screamin' Eagle® Pro Street Tuner (sold separately). **Pending Regulatory approval for '19-later models. Refer to the product information at www.H-D.com/shop for status.**

B. SCREAMIN' EAGLE HIGH-CAPACITY TAPPETS

Screamin' Eagle Tappets feature large high capacity needles in the roller bearing assembly to improve reliability when operating with high lift cams, high pressure valve springs and in high RPM applications. The 25% larger needle bearings increase the dynamic load rating by approximately 20% when compared to the Original Equipment Twin Cam tappets. The unique design delivers superior tappet life in performance applications. Set of 4.

18572-13 **\$249.95**

Fits '17-later Milwaukee-Eight® Engine equipped models, '00-later XL and XR models and '99-'17 Twin Cam-equipped models.

C. SCREAMIN' EAGLE PERFORMANCE VALVE SPRING KIT

This performance beehive-shaped Valve Spring Kit will permit the Sportster® engine to rev to 7000 RPM. The unique ovate wire yields increased performance from a compact spring design. The installed spring pressure is increased to 208 lbs and allows a maximum lift of .590". Complete kit includes springs, upper collars and keepers and lower collars with integral valve seals.

18013-03A **\$149.95**

Fits '04-later XL, XR and '05-'17 Twin Cam-equipped models. Does not fit FXDLS, FLSS, FLSTFBS or Screamin' Eagle Performance Heads with .3125" diameter valves.

STAGE II



A. SCREAMIN' EAGLE PERFORMANCE II SE-585 CAM KIT- SPORTSTER

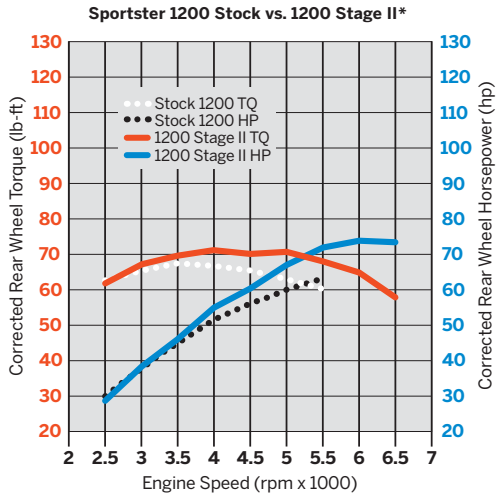

*'14-later XL1200 Stage II with Heavy Breather A/C & Street Cannon Mufflers

Street legal and/or street compliant statements refer to product meeting 50-State emissions and noise standards in the United States.

The street legal and/or street compliant statements may not apply to markets outside of the United States.

Notice: The prices appearing in this catalog are the manufacturer's suggested retail prices. Actual retail prices may vary.



B. SCREAMIN' EAGLE HIGH-CAPACITY TAPPETS



C. SCREAMIN' EAGLE PERFORMANCE VALVE SPRING KIT

STAGE IV

SCREAMIN' EAGLE® 505

Sportster® Stage IV Upgrade



SCREAMIN' EAGLE® SPORTSTER® CONVERSION KIT – 883CC TO 1200CC*

Make your Iron 883™ model roar. This complete conversion kit will alter the personality of your 883-equipped Sportster® model. Designed to bring your XL883 model up to XL1200 specifications. No case machining is required for installation. 50-State U.S. EPA compliant.

Kit includes:
 Sportster High-Flow Air Cleaner Kit
 XL1200 Cylinder Heads
 XL1200 Cylinders
 XL1200 Pistons and Rings
 Heavy Duty Clutch Spring
 Top End Gasket Kit

29784-07 Black Highlighted. **\$1,199.95**
 Fits 50-state '07-later XL883 models. All models require ECM calibration for proper installation. '17-later models require recalibration with Screamin' Eagle® Pro Street Tuner (sold separately).

30003-10 Black Non-Highlighted. **\$1,199.95**
 Fits 50-state '08-later XL883 models. All models require ECM calibration for proper installation. '17-later models require recalibration with Screamin' Eagle Pro Street Tuner (sold separately).

When installed by an authorized Harley-Davidson® Dealer within 60-days of the vehicle purchase, compliant kits do not impact the vehicle's limited warranty.

Sportster 883 Stock vs. 883 to 1200 Conversion*

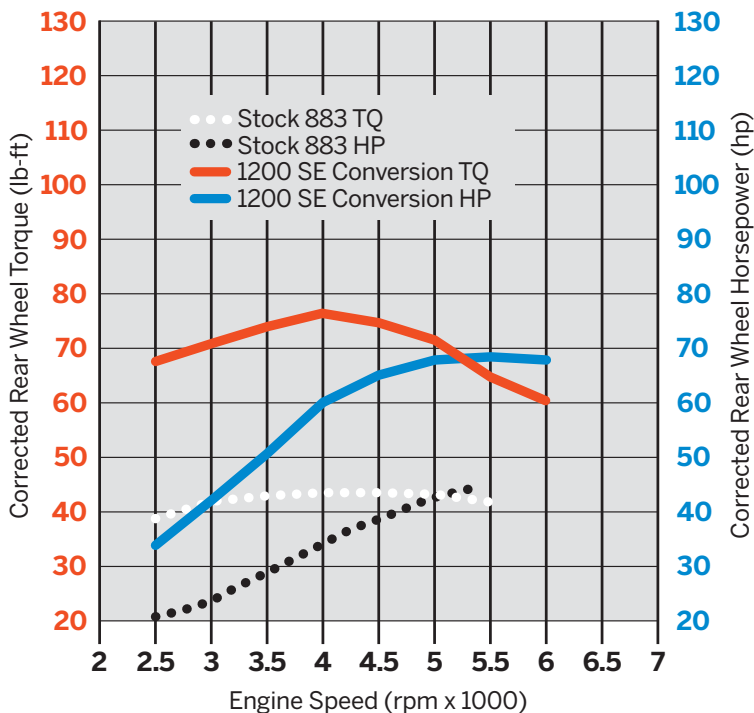

* 883 to 1200 Conversion with Street Cannon Mufflers

Street legal and/or street compliant statements refer to product meeting 50-State emissions and noise standards in the United States.

The street legal and/or street compliant statements may not apply to markets outside of the United States.

Notice: The prices appearing in this catalog are the manufacturer's suggested retail prices. Actual retail prices may vary.

506 SCREAMIN' EAGLE®

Sportster® Stage IV Upgrade

STAGE IV

SCREAMIN' EAGLE® SPORTSTER® STAGE IV KIT – 1200CC TO 1200CC

Maximize the horsepower and torque available for your street compliant Sportster® model. This complete engine package includes all the components you need to build a high-performance ride while still retaining the original factory warranty. Installation does not require removal of the powertrain from the chassis. 50-State U.S. EPA compliant.

Kit includes:

- CNC-Ported Cylinder Heads with Performance Valve Springs
- Screamin' Eagle® XL SE-585 Cams
- Forged Hi-Compression 10.5:1 Pistons and Rings
- 58mm Throttle Body and Intake Manifold
- Top End Gasket Kit

Fits '14-later XL1200 models. Requires separate purchase of 58mm compatible accessory air cleaner. All models require ECM calibration for proper installation. '17-later models require recalibration with Screamin' Eagle Pro Street Tuner (sold separately). **Pending Regulatory approval for '19-later models. Refer to the product information at www.H-D.com/shop for status.**

92500041	Black Highlighted Heads.	\$2,159.95
92500042	Black Non-Highlighted Heads.	\$2,159.95

When installed by an authorized Harley-Davidson® Dealer within 60-days of the vehicle purchase, compliant kits do not impact the vehicle's limited warranty.



Sportster 1200 Stock vs. 1200 Stage IV*

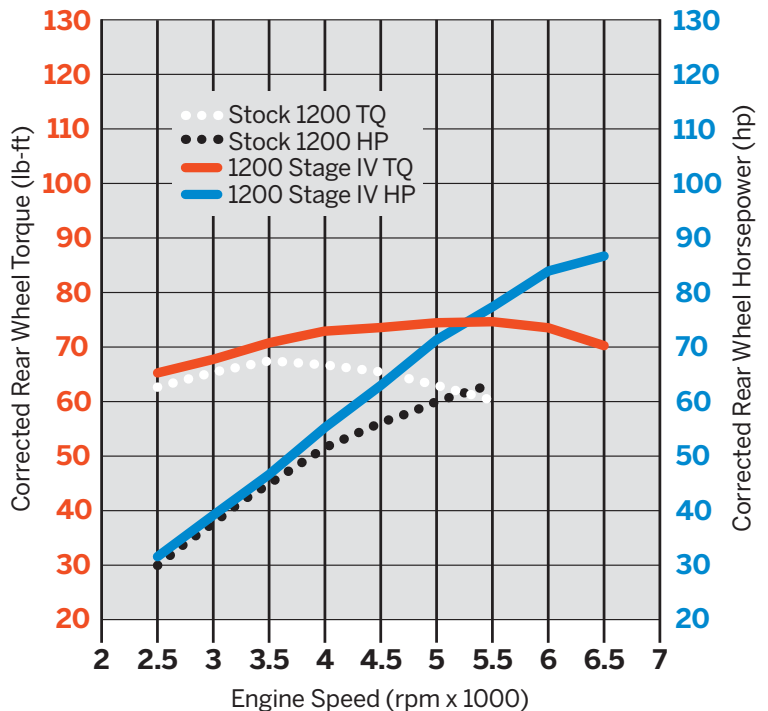

Street legal and/or street compliant statements refer to product meeting 50-State emissions and noise standards in the United States.

The street legal and/or street compliant statements may not apply to markets outside of the United States.

Notice: The prices appearing in this catalog are the manufacturer's suggested retail prices. Actual retail prices may vary.

*1200 Stage IV with 58MM Heavy Breather A/C & Street Cannon Mufflers

SCREAMIN' EAGLE® MULTI-FIT ACCESSORIES

When building a performance powertrain, don't overlook the small stuff. After all, good clean air and a powerful spark are essential for maximum power and engine life. Air cleaner covers and washable K&N® air filters are available to dress your bike in style while maximizing the flow of air to your engine. And Screamin' Eagle® premium spark plugs and plug wires will keep the fire burning.



508 SCREAMIN' EAGLE®

Air Filters

A. SCREAMIN' EAGLE® HIGH-FLO K&N® REPLACEMENT AIR FILTER ELEMENT

K&N® replacement air filters are engineered to improve airflow for increased horsepower and quicker acceleration. K&N filters provide excellent filtration, and because they are washable and reusable, you can clean the filter whenever conditions demand. Designed as direct replacements for specified fitments.

1. 29400020 High-Flow – Multi-fit. **\$59.95**
Fits '07-later XL, '99-'07 Dyna®, '00-'15 Softail® and '99-'07 Touring models equipped with High-Flow Air Cleaner Kits. Replacement for P/N 29442-99E.

1. 29400358 High-Flow – Multi-fit. **\$59.95**
Fits '18-later Softail and '17-later Touring and Trike models equipped with round High-Flow Air Cleaner P/N 29400355 or 29400356.

2. 29400021 High-Flow – Dyna. **\$59.95**
Fits '08-'17 Dyna models equipped with High-Flow Air Cleaner Kits. Replacement for P/N 29385-08.

3. 29400019 High-Flow – Touring. **\$59.95**
Fits '16-'17 Softail and '08-'16 Touring and Trike models equipped with High-Flow Air Cleaner Kits. Replacement for P/N 29244-08.

4. 29400247 High-Flow – Wedge Milwaukee-Eight® Engine. **\$69.95**
Fits '17-later Touring and Trike models equipped with Wedge High-Flow Air Cleaner Kit P/N 29400245 or 29400246.

5. 29400065 Extreme Billet. **\$59.95**
Fits '15-later XG, '16-'17 Softail, and '08-later Touring and Trike models equipped with Extreme Billet Agitator and Chisel Air Cleaner Kits.

5. 29400359 Extreme. **\$69.95**
Fits '18-later Softail and '17-later Touring and Trike models equipped with round High-Flow Air Cleaner P/N 29400357.

5. 29400118 Extreme Billet & Rail. **\$59.95**
Fits '07-later XL, '08-'17 Dyna and '08-'15 Softail and models equipped with Extreme Billet Chisel and Agitator or Rail Collection Air Cleaner Kits.

6. 29400109 Burst Collection. **\$59.95**
Fits '08-'17 Dyna and Softail models, '08-'16 Touring and Trike models equipped with Burst Collection Air Cleaner Kits.

7. 29400022A Ventilator – Multi-fit. **\$59.95**
Fits models equipped with Twin-Cam Ventilator and Extreme Billet Ventilator Performance Air Cleaner Kits. Replacement for P/N 29670-09.

8. 29400293 Ventilator – Milwaukee-Eight® Engine. **\$59.95**
Fits '18-later Softail, '17-later Touring and Trike models equipped with Ventilator Air Cleaner P/N 29400298 or 29400299.

9. 29424-05B Heavy Breather – Multi-fit, Chrome. **\$89.95**
Fits models equipped with Heavy Breather Kit P/N 29098-09, 29299-08, 29080-09 or 29264-08.

9. 29702-08B Heavy Breather – Touring, Chrome. **\$89.95**
Fits models equipped with Heavy Breather Kit P/N 29006-09B, 29253-08B, 29000065 or 29400105.

29400297 Heavy Breather – Touring, Black. **\$119.95**
Fits '16-'17 FXDLS and models equipped with Heavy Breather Kit P/N 29006-09B, 29253-08B, 29000065 or 29400105.

10. 28714-10 Heavy Breather – Compact, Chrome. **\$89.95**
Fits '08-'16 Touring and Trike models equipped with Compact Heavy Breather Kit P/N 28716-10A.

11. 29400141 Heavy Breather Elite, Chrome. **\$109.95**
Fits models equipped with Screamin' Eagle Heavy Breather Elite Performance Air Cleaner Kit P/N 29400172 and 29400173.

27300139 Heavy Breather Elite, Black. **\$119.95**
Replacement air filter for models equipped with Screamin' Eagle Heavy Breather Elite Performance Air Cleaner Kit P/N 29400285.

12. 29400276 Heavy Breather – Milwaukee-Eight Engine, Black. **\$109.95**
Fits '18-later Softail, '17-later Touring and Trike models equipped with Heavy Breather Air Cleaner P/N 29400263 or 29400264.

13. 29400275 Heavy Breather – Milwaukee-Eight Engine, Chrome. **\$109.95**
Fits '18-later Softail, '17-later Touring and Trike models equipped with Heavy Breather Air Cleaner P/N 29400263 or 29400264.



A. SCREAMIN' EAGLE HIGH-FLO K&N REPLACEMENT AIR FILTER ELEMENT



Also available in Black

Also available in Black

A. SCREAMIN' EAGLE HIGH-FLO K&N REPLACEMENT AIR FILTER ELEMENT – HEAVY BREATHER



A. SCREAMIN' EAGLE HIGH-FLO K&N REPLACEMENT AIR FILTER ELEMENT – MILWAUKEE-EIGHT HEAVY BREATHER

Notice: The prices appearing in this catalog are the manufacturer's suggested retail prices. Actual retail prices may vary.

SCREAMIN' EAGLE® 509

Spark Plugs

B. SCREAMIN' EAGLE® PERFORMANCE SPARK PLUGS

Screamin' Eagle® Spark Plugs feature double platinum coating for superior erosion resistance and extended life. The "V" trimmed ground electrode reduces shrouding of the flame front to promote flame propagation, and the fine wire center electrode enhances startups and ignitability. Screamin' Eagle Plugs feature Ribbed Core Technology (RCT) that provides resistance to fouling, and are designed with Original Equipment-style noise suppression to prevent electrical interference with radios and CB communication equipment. Works great in racing applications where rich air/fuel conditions are required. Unique style with Screamin' Eagle logo. Sold in pairs.

Standard Compression Applications

Designed for modified engines including performance carburetors, high-flow air cleaners, camshafts, exhaust systems and ignition systems in conjunction with stock compression ratios.

31600106 Standard Compression Applications. **\$19.95**
Fits '99-later Twin Cam-equipped models, and '86-later Evolution® Sportster® 883, 1100 and 1200 models.

31600085 Standard Compression Applications. **\$19.95**
Fits '15-later XG models and '17-later Milwaukee-Eight® engine equipped models.

High Compression Applications

These plugs are designed for high performance applications involving modifications in high-flow air cleaners, camshafts, exhaust, performance heads, ignition components, higher compression ratios above Original Equipment configurations or engines specific for racing applications.

31600105 High Compression Applications. **\$19.95**
Fits '99-later Twin Cam-equipped models, '86-later XL and XR and Evolution 1340 models equipped with Screamin' Eagle Performance Cylinder Heads.

C. SCREAMIN' EAGLE 10MM PHAT SPARK PLUG WIRES – CUT TO LENGTH

Fat 10mm plug wires add dimension and style to your ride. Screamin' Eagle boot design and suppression core wires ensure solid connection and maximum voltage transfer between coil and plugs. Screamin' Eagle script printed along the wire to add style.

32095-98B Black. **\$29.95**
Multi-Fit – Cut to length. Fits '86-'03 XL models (except XL1200S), '91-'98 Dyna® models, '85-'99 Softail® models and '80-'84 Touring models.

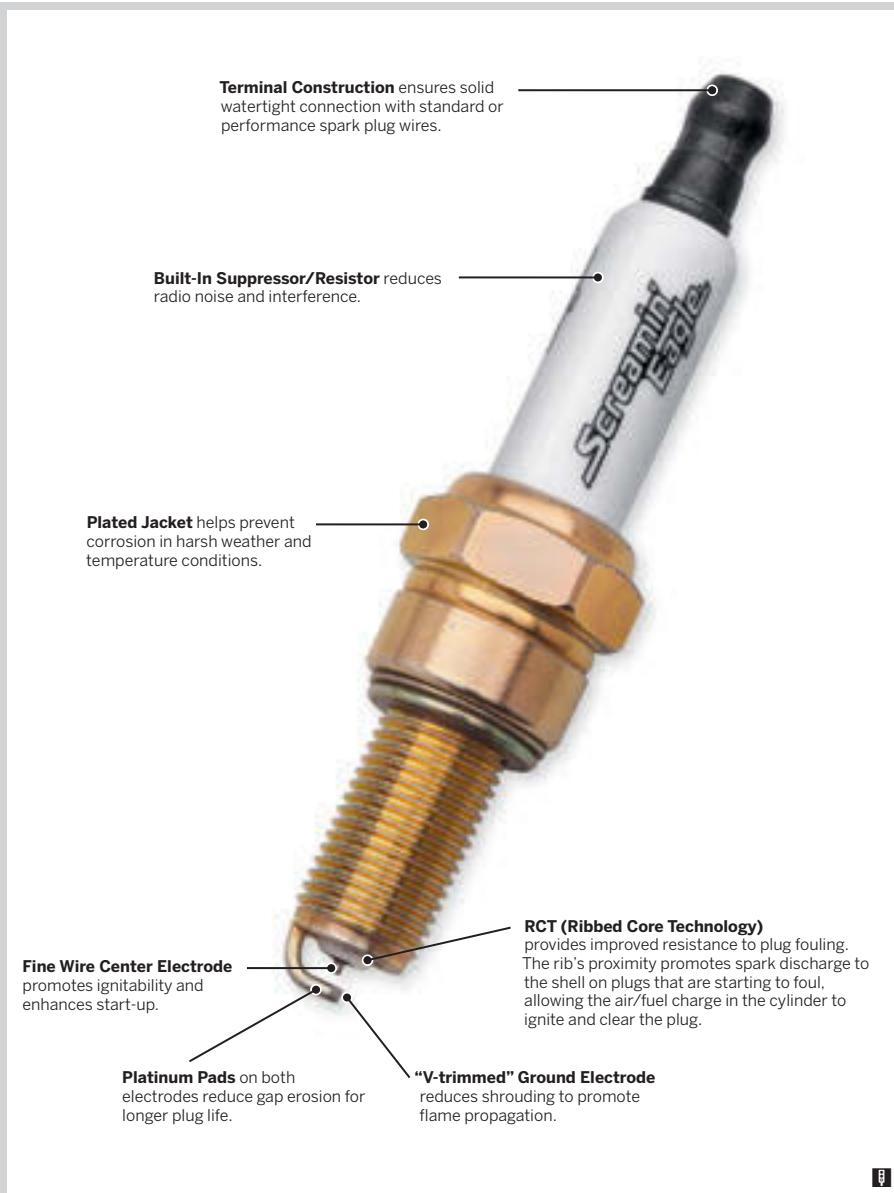

B. SCREAMIN' EAGLE PERFORMANCE SPARK PLUG



C. SCREAMIN' EAGLE 10MM PHAT SPARK PLUG WIRES – CUT TO LENGTH

Street legal and/or street compliant statements refer to product meeting 50-State emissions and noise standards in the United States.

The street legal and/or street compliant statements may not apply to markets outside of the United States.

Notice: The prices appearing in this catalog are the manufacturer's suggested retail prices. Actual retail prices may vary.

510 SCREAMIN' EAGLE®

Spark Plug Wires

A. SCREAMIN' EAGLE® 10MM PHAT SPARK PLUG WIRES

Fat 10mm plug wires add dimension and style to your ride. Screamin' Eagle® boot design and suppression core wires ensure solid connection and maximum voltage transfer between coil and plugs. Screamin' Eagle script printed along the wire to add style.

Fits '15-later XG models.

31600048A	Black.	\$29.95
31600051A	Orange.	\$29.95
31600054A	Red.	\$29.95

Fits '07-later XL models.

31901-08A	Black.	\$29.95
31902-08A	Orange.	\$29.95

Fits '04-'06 XL models.

31958-04B	Black.	\$29.95
31956-04B	Orange.	\$29.95

Fits '86-'03 XL models (except XL1200S).

32092-98B	Black.	\$29.95
31963-89B	Orange.	\$29.95

Fits '99-'17 Dyna® models.

31930-99C	Black.	\$29.95
31944-99C	Orange.	\$29.95
31937-99C	Red.	\$29.95

Fits '91-'98 Dyna, '85-'99 Softail® and '80-'84 Touring models.

32093-98B	Black.	\$29.95
31964-89C	Orange.	\$29.95

Fits '18-later Softail models.

31600111	Black.	\$54.95
31600113	Orange.	\$54.95
31600112	Red.	\$54.95

Fits '00-'17 Softail models (except FXCW, FXCWC, FXS and '13-'16 FXSB models).

31907-08A	Black.	\$29.95
32360-00C	Orange.	\$29.95
32359-00C	Red.	\$29.95

Fits '08-'16 FXCW, FXCWC, FXS and FXSB models.

31965-08A	Black.	\$29.95
31967-08A	Red.	\$29.95

Fits '17-later Touring and Trike models.

31600108	Black.	\$54.95
31600110	Orange.	\$54.95
31600109	Red.	\$54.95

Fits '09-'16 Touring and Trike models.

32303-08A	Black.	\$29.95
32325-08A	Orange.	\$29.95
32318-08A	Red.	\$29.95

Fits '99-'08 Touring models.

31932-99C	Black.	\$29.95
31946-99C	Orange.	\$29.95
31939-99C	Red.	\$29.95



A. SCREAMIN' EAGLE 10MM PHAT SPARK PLUG WIRES – RED



A. SCREAMIN' EAGLE 10MM PHAT SPARK PLUG WIRES – ORANGE

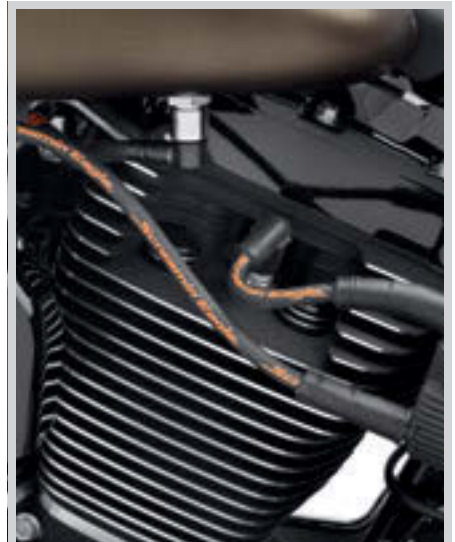

A. SCREAMIN' EAGLE 10MM PHAT SPARK PLUG WIRES – BLACK



A. SCREAMIN' EAGLE 10MM PHAT SPARK PLUG WIRES

Street legal and/or street compliant statements refer to product meeting 50-State emissions and noise standards in the United States.

The street legal and/or street compliant statements may not apply to markets outside of the United States.

Notice: The prices appearing in this catalog are the manufacturer's suggested retail prices. Actual retail prices may vary.

SCREAMIN' EAGLE® CRATE ENGINE & DRIVE TRAIN COMPONENTS

Fresh from the factory, Harley-Davidson® Crate Engines are the ideal platform for building your high-performance ride. And once you've put your heart and soul into achieving just the type of horsepower and torque numbers you crave, we offer everything you need to get all that power to the pavement.

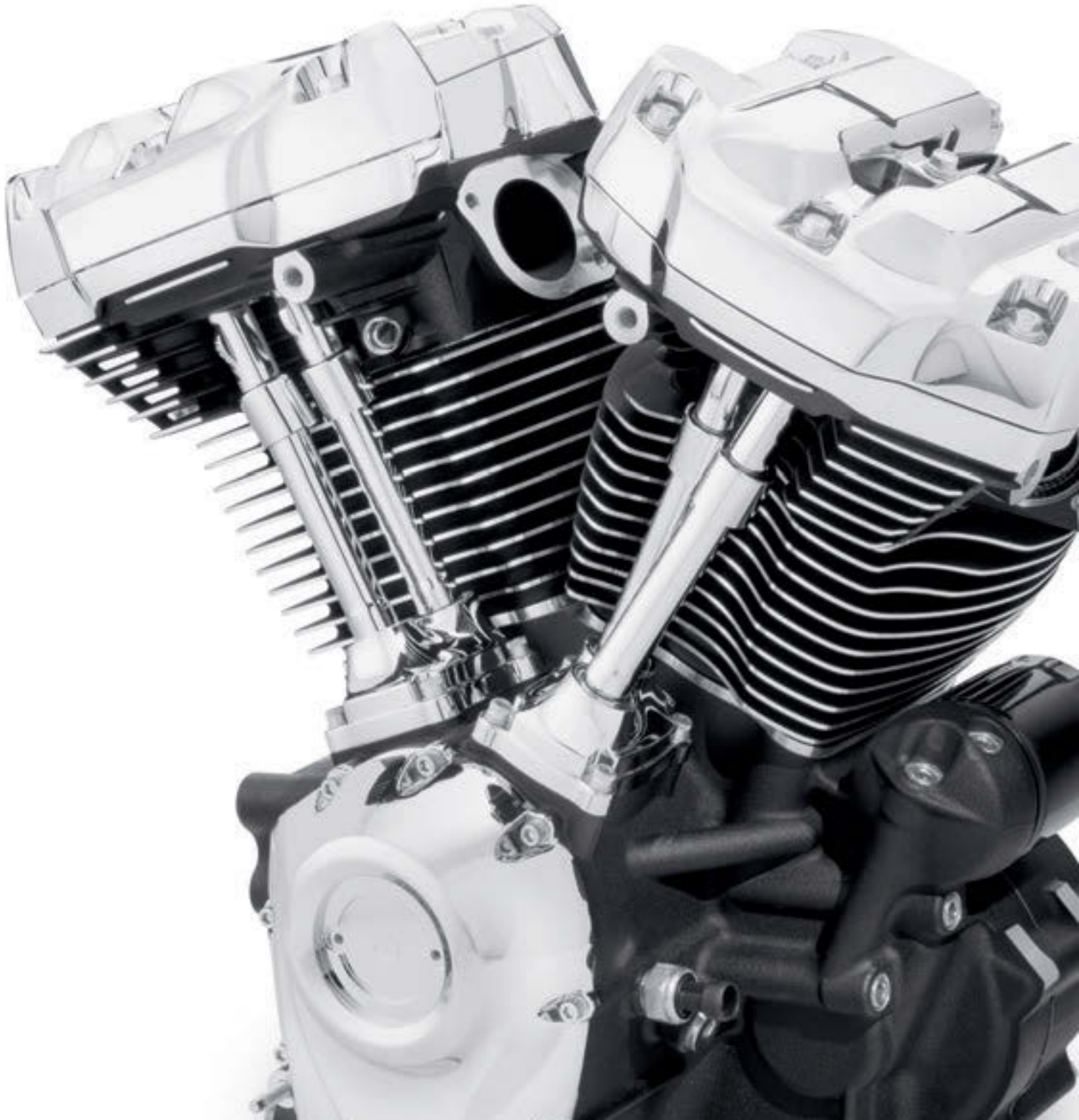

512 SCREAMIN' EAGLE®

Milwaukee-Eight® Engines

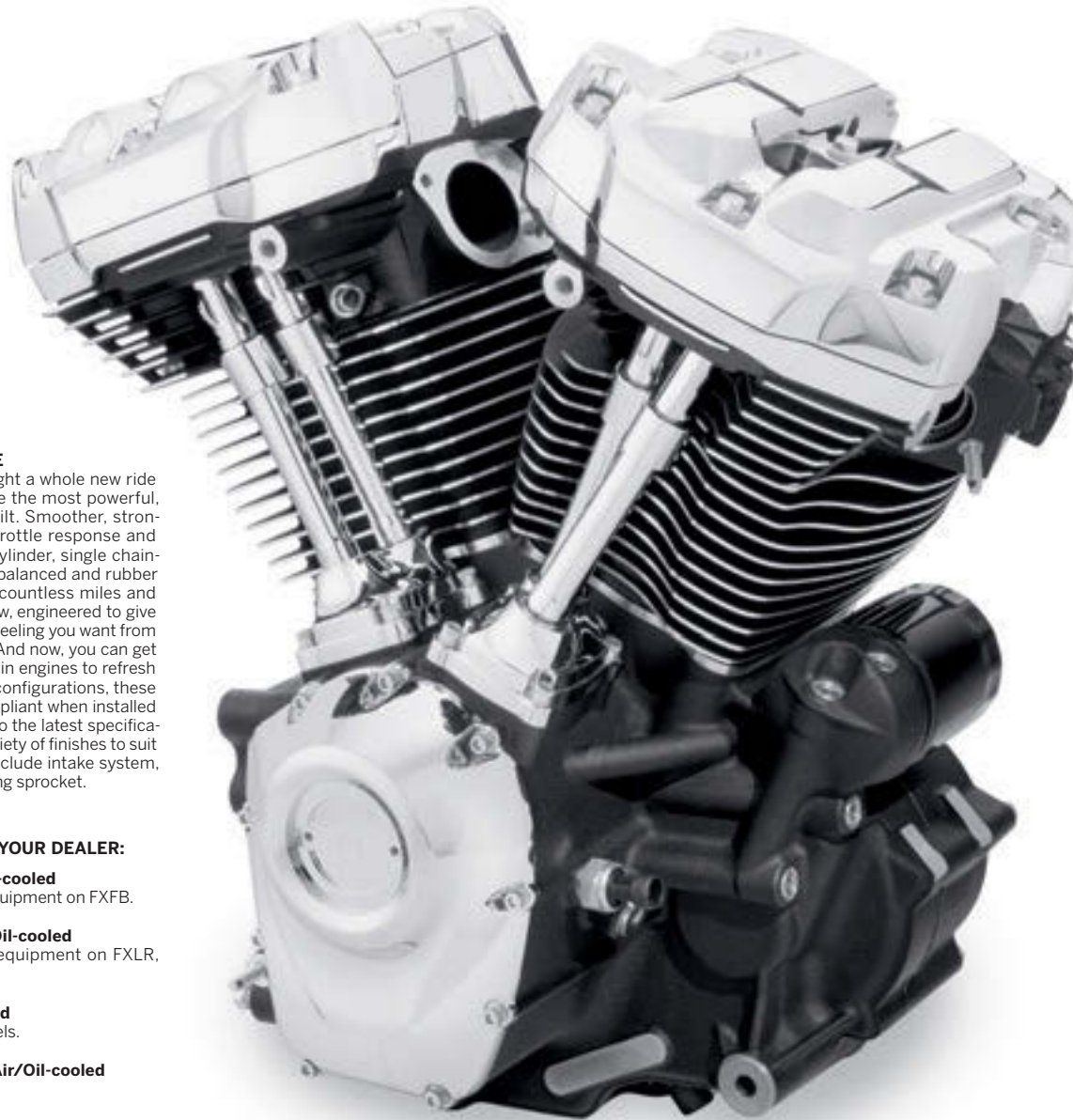

A. MILWAUKEE-EIGHT® CRATE ENGINE

The Milwaukee-Eight® engine has brought a whole new ride to the Harley-Davidson® family. They're the most powerful, coolest-running motors we've ever built. Smoother, stronger and more durable. With crisper throttle response and truer, cleaner sound. Four valves per cylinder, single chain-driven cam, dual spark plugs, counter-balanced and rubber mounted. Developed and proven over countless miles and millions of hours. Every single part is new, engineered to give you more performance and more of the feeling you want from an engine. Today, it's a whole new ride. And now, you can get the most technologically advanced V-Twin engines to refresh your ride. Available in 107CI and 114CI configurations, these Milwaukee-Eight engines are street compliant when installed in the models specified. Manufactured to the latest specifications, these engines are available in a variety of finishes to suit your customizing direction. Does not include intake system, timer cover, stator, rotor, or compensating sprocket.

See your Dealer for details.

CRATE ENGINES AVAILABLE FROM YOUR DEALER:

107 Black with Black Covers – Air/Oil-cooled

Fits '18-later Softail® models. Original equipment on FXFB.

107 Black with Chrome covers – Air/Oil-cooled

Fits '18-later Softail models. Original equipment on FXLR, FXBR, and FLDE.

107 Black and Chrome – Air/Oil-cooled

Fits '17-later Touring Air/Oil-cooled models.

107 Black with Gloss Black Covers – Air/Oil-cooled

Fits '17-later Touring models.

107 Black and Chrome – Twin-Cooled™

Fits '17-later Touring Twin-Cooled™ models.

114 Black with Black Covers – Air/Oil-cooled

Fits '18-later Softail models. Original equipment on FXFBS.

114 Black with Chrome Covers – Air/Oil-cooled

Fits '17-later Touring models. Original equipment on '18 FLRT.

114 Black with Chrome Covers – Air/Oil-cooled

Fits '18-later Softail models. Original equipment on FXBRS.

114 Black with Gloss Black Covers – Air/Oil-cooled

Fits '17-later Touring models.

114 Black with Chrome Cover – Twin-Cooled

Fits '17-later Touring Twin-Cooled models. Original equipment on '19 FLHTK.

A. MILWAUKEE-EIGHT CRATE ENGINES

NOTE: Replacement engines must be re-fitted with emission control devices and systems, appropriate for the vehicle model and model year in order to ensure emissions compliance. Failure to do so constitutes tampering under US EPA guidelines and can lead to substantial fines and penalties.

Legal for use on public roads only when installed in the specified models. Not legal for use on public roads when installed in models other than the ones specified and not eligible for the P&A 24-month warranty when installed in models other than the ones specified. Please see the Parts and Accessories warranty statement and your dealer for more information.

Street legal and/or street compliant statements refer to product meeting 50-State emissions and noise standards in the United States.

The street legal and/or street compliant statements may not apply to markets outside of the United States.

SCREAMIN' EAGLE® 513

Twin Cam SE120ST Crate Motor



B. SCREAMIN' EAGLE® SE120ST STREET PERFORMANCE CRATE MOTOR

This street-tuned 120 cubic inch Screamin' Eagle® Crate Motor takes your bagger from mild to wild. This engine is designed for bolt-in installation in the Original Equipment-style chassis of your Touring bike. No special fabrication or engine mount relocation is required. The crankcase, cylinders and heads are painted black, and feature machined aluminum highlights and chrome covers for a stunning "show-and-go" look. Equipped with the ultimate large bore Screamin' Eagle 58mm Throttle Body (18% larger than stock), this engine is capable of producing 106 horsepower and 117 lb-ft of torque at the rear wheel. Engine features One-Year Manufacturers warranty. For best performance results, we recommend combining this engine with your choice of Screamin' Eagle 58mm High-Flow Air Cleaner and the Screamin' Eagle High Flow Exhaust System P/N 64800022.

This engine is 50-State U.S. EPA compliant when used with Original Equipment mufflers or the Screamin' Eagle Street Performance Exhaust System P/N 64800022. All models require ECM calibration (priced separately). U.S. delivered engines include Manufacturers Statement of Origin (MSO).

Developed and tested in Milwaukee, this motor features the finest Screamin' Eagle components:

- 4.060 big-bore cylinders.
- 4-5/8" stroke SE Pro stroker flywheel and rod assembly.
- 10.5:1 high-compression nickel-plated forged pistons with Teflon® coated skirt.
- Titanium SST piston rings.
- SE-259E high-lift cams.
- Perfect-Fit pushrods.
- SE high-performance lifters.
- CNC-ported MVA heads with automatic compression release.
- Screamin' Eagle Pro High-Flow 58mm EFI Throttle Body, high flow injectors and manifold clamps.
- Machined lower rocker boxes for valve spring collar clearance.
- Factory-machined engine cases.
- Unique piston oilers for stroker clearance.
- Screamin' Eagle inner crankcase full complement cam needle bearings.
- SE Lefty high-performance crankcase output bearing and nitride bearing race.
- SE Performance spark plugs.
- 120ST cam cover and cylinder head medallions.

19221-15 \$5,995.00

Fits 50-state '10-'16 Touring models. Does not fit Twin-Cooled™ models. Does not fit Trike. '10 Touring models require Screamin' Eagle Big Twin Compensator Kit P/N 40100061. All models require ECM calibration for proper installation. '10-'13 Touring models can be programmed by Dealer (sold separately). '14-'16 Touring models can be calibrated using the Screamin' Eagle Pro Street Tuner (sold separately).

Twin Cam 103HO Stock vs. SE120ST Crate Motor with Stock Exhaust

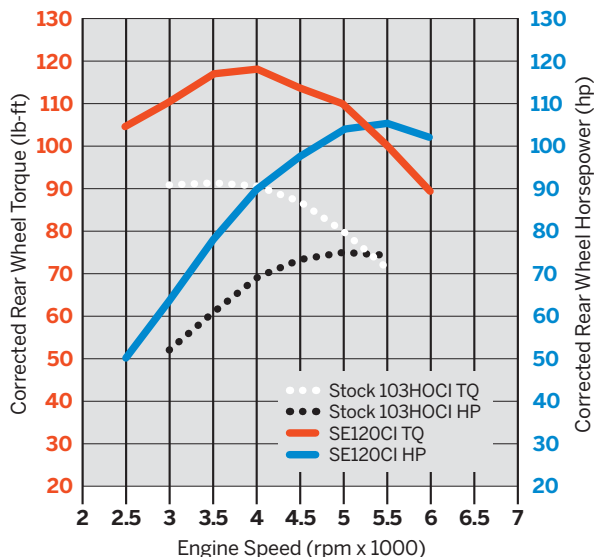

Street legal and/or street compliant statements refer to product meeting 50-State emissions and noise standards in the United States.

The street legal and/or street compliant statements may not apply to markets outside of the United States.

Notice: The prices appearing in this catalog are the manufacturer's suggested retail prices. Actual retail prices may vary.

514 SCREAMIN' EAGLE®

Clutch & Drivetrain

A. SCREAMIN' EAGLE® HIGH CAPACITY CLUTCH KIT – MILWAUKEE-EIGHT® ENGINE

The Screamin' Eagle® High Capacity Clutch Kit increases the drivetrain's ability to reliably support high torque applications without significantly increasing lever effort. Designed to fit in the stock clutch basket, this kit provides smooth shifting, progressive engagement, and works with the factory Assist and Slip clutch system to keep clutch lever effort similar to the stock levels. Kit contains 10 fiber clutch plates and 10 contact plates – one more than Original Equipment – and 3-1200 Newton clutch springs. This combination provides 11% more clutch surface area for greater power handling capability.

37000287 **\$219.95**
Fits '18-later Softail® and '17-later Touring models.

B. SCREAMIN' EAGLE HIGH CAPACITY CLUTCH PLATE KIT – MILWAUKEE-EIGHT ENGINE

Replacement clutch plates for the Screamin' Eagle High Capacity Clutch Kit P/N 37000287. Kit includes 10 fiber friction plates and 10 contact plates.

37000258 **\$199.95**
Fits '18-later Softail and '17-later Touring models.

C. MILWAUKEE-EIGHT ENGINE CLUTCH SPRINGS – 1275N

High tension springs are engineered to add additional clutch capacity in high torque and high horsepower applications. Kit includes 3-1275 Newton (N) coil springs, and is designed to complement the Screamin' Eagle High Capacity Clutch Plate Kit P/N 37000258. When combined with the High Capacity Clutch Plate Kit, torque capacity is increased to the maximum level available. Installation will increase capacity and lever effort. Springs can be installed without removing the outer primary cover.

37000286 **\$24.95**
Fit's '18-later Softail and '17-later Touring models.

D. MILWAUKEE-EIGHT ENGINE CLUTCH SPRINGS – 1200N

Replacement clutch springs for the Screamin' Eagle High Capacity Clutch Kit P/N 37000287. Kit includes 3-1200 Newton (N) coiled clutch springs. Installation of these springs with Original Equipment clutch plates will increase clutch capacity and lever effort. Springs can be installed without removing the outer primary cover. Included in Milwaukee-Eight® Stage III and IV Kits.

37000288 **\$24.95**
Fit's '18-later Softail and '17-later Touring models.



A. SCREAMIN' EAGLE HIGH CAPACITY CLUTCH KIT – MILWAUKEE-EIGHT ENGINE

Configuration	Max Crankshaft Torque (ft. lbs.)	% Increase in Torque Capacity Over Milwaukee-Eight® 107 OE Clutch	Approximately Lever Effort (lb)
Milwaukee-Eight 107CI Original Equipment (9-Disk/1100N Spring)	125	—	14.6
9 Disk/1200N Spring	134	7.2%	16
9 Disk/1275 Spring	143	14.4%	17
Milwaukee-Eight 114CI Original Equipment (10 Disk/1100N Spring) (P/N 37000287)	139	11.2%	14.6
Screamin' Eagle High Capacity Clutch Kit 10 Disk/1200N Spring	150	20%	16
10 Disk/1275N Spring	160	28%	17



B. SCREAMIN' EAGLE HIGH CAPACITY CLUTCH PLATE KIT – MILWAUKEE-EIGHT ENGINE



C. MILWAUKEE-EIGHT ENGINE CLUTCH SPRINGS – 1275N



D. MILWAUKEE-EIGHT ENGINE CLUTCH SPRINGS – 1200N

Street legal and/or street compliant statements refer to product meeting 50-State emissions and noise standards in the United States.

The street legal and/or street compliant statements may not apply to markets outside of the United States.

Notice: The prices appearing in this catalog are the manufacturer's suggested retail prices. Actual retail prices may vary.

SCREAMIN' EAGLE® 515

Clutch & Drivetrain



E. SCREAMIN' EAGLE BIG TWIN COMPENSATOR

E. SCREAMIN' EAGLE® BIG TWIN COMPENSATOR

This premium compensator has been engineered with heavier springs and increased travel to support the high torque output associated with high compression race and large displacement engines. Designed to outperform the Original Equipment compensator, this unit helps protect the engine and driveline components during harsh drag race launches. Compensator features improved oil passages, oil deflectors and a needle bearing thrust washer that improves the overall operation of these components.

42200064A \$299.95

Fits '12-'13 Dyna®, '12-'13 Softail® (except FXCW, FXCWC, FXSB, FXSBSE and '09 FXSTSSE), '11-'13 Touring and '09-'13 Trike models. Original Equipment on '14-'17 Dyna, Softail and '14-'16 Touring models. Requires separate purchase of Installation Adhesive Kit P/N 11100088.

40100061 \$409.95

Fits '06-'11 Dyna, '07-'11 Softail (except FXCW and FXCWC), '07-'10 Touring, and '07-'09 CVO™ (except '09 FXSTSSE) models. Does not fit Trike. Requires separate purchase of Installation Adhesive Kit P/N 11100088. Kit includes Rotor Assembly P/N 30041-08. Installation on '06 Dyna models require separate purchase of '07-style stator.

42200095A \$299.95

Fits '08-'12 FXCWC and '09 FXSTSSE models and '13-later FXSB models. If P/N 40274-08A has been installed previously, the rotor shell, P/N 30041-08A is not required.

F. SCREAMIN' EAGLE VARIABLE PRESSURE CLUTCH

Get more performance from the Original Equipment clutch. The Screamin' Eagle® Variable Pressure Clutch is designed to help put the added power from a Screamin' Eagle Stage Kit to the pavement. This bolt-on kit harnesses the centrifugal force of spinning weights to increase the clutch capacity as engine speed increases. The mechanism applies increasing pressure to the stock clutch pressure plate as RPM rises. The result: High torque-handling capabilities without increasing clutch lever effort at idle. The Variable Pressure Clutch also provides smoother clutch disengagement at lower speed. Kit fits behind most stock derby covers with no modifications. See installation manual for additional accessory derby cover fitment information.

To match the performance demands of your engine, team the Variable Pressure Clutch with your choice of clutch diaphragm springs. We recommend the higher capacity Screamin' Eagle Diaphragm Spring P/N 37951-98 for major performance upgrades.

	Lever Effort	Torque Capacity
Original Equipment Spring	Same as stock	120 ft-lbs
SE Spring P/N 37951-98	35% greater than stock	153 ft-lbs

37000121A \$299.95

Fits '99-'17 Evolution® 1340 and Twin Cam-equipped models. Will not fit '16-later Touring and Trike models, '15-later FLHTCUL or FLHTKL models or '07-later Touring or Trike models equipped with Narrow-Profile Outer Primary Cover P/N 25700385 or 25700438. Will not fit '13-later CVO models with hydraulic actuated clutch, '16-'17 FXDLS, FLSS and FLSTFBS, or '14-later Touring and Trike models equipped with Screamin' Eagle A&S Clutch Kit P/N 37000026. Derby Covers P/N 25001-03, 25441-04A, 25770-99, 25331-10, 25339-10, 25700250 and 25700062 require Spacer Kit P/N 37000123. Does not fit Derby Covers P/N 25347-02 or 25345-01.



F. SCREAMIN' EAGLE VARIABLE PRESSURE CLUTCH

Street legal and/or street compliant statements refer to product meeting 50-State emissions and noise standards in the United States.

The street legal and/or street compliant statements may not apply to markets outside of the United States.

Notice: The prices appearing in this catalog are the manufacturer's suggested retail prices. Actual retail prices may vary.

516 SCREAMIN' EAGLE®

Clutch & Drivetrain

A. SCREAMIN' EAGLE® TWIN CAM PERFORMANCE ASSIST AND SLIP (A&S) CLUTCH KIT

Developed for the high-thrust 1100ci engine featured as Original Equipment on '14-later CVO™ models, this A&S clutch provides significantly increased torque-handling capacity (135lb/ft). Clutch is designed to improve engagement grip and provides minor slippage during downshifting to reduce shock to the power train. Reduces hand lever pull effort by over 1 pound. Complete kit features improved clutch plates for enhanced wear resistance and is the perfect addition when installing a high-output Screamin' Eagle® Stage Kit.

37000026 **\$399.95**

Fits '14-'16 Touring and Trike models with hydraulic clutch actuator. Original Equipment on FXDLS, FLSS, FLSTBS and FXSE models.



A. SCREAMIN' EAGLE TWIN CAM PERFORMANCE ASSIST AND SLIP CLUTCH KIT

B. SCREAMIN' EAGLE PERFORMANCE CLUTCH FRICTION DISC KIT

Newly-developed friction material delivers longer life than Original Equipment friction discs. Kit includes new precision-machined flat steel plates. This Friction Disc Kit is a perfect match for the Screamin' Eagle Twin Cam Performance Race Clutch Hub Kit P/N 37976-08.

37980-10 **\$179.95**

Fits '99-'17 Twin Cam-equipped models and '98-'99 Evolution® 1340-equipped models. Will not fit '13-'16 CVO Touring models with hydraulic actuated clutch or, '15-'16 FLHTCUL and FLHTKL, '16-'17 FXDLS, FLSS, FLSTFBS, FXSE or '13-'16 CVO Touring models with hydraulic actuated clutch, '15-'16 FLHTCUL and FLHTKL or '14-'16 Touring and Trike models equipped with Screamin' Eagle A&S Clutch Kit P/N 37000026.



B. SCREAMIN' EAGLE PERFORMANCE CLUTCH FRICTION DISC KIT

C. HEAVY DUTY CLUTCH SPRING FOR STOCK CLUTCH

37951-98 **\$34.95**

Fits '99-'17 Twin Cam-equipped models and '98-'99 Evolution 1340-equipped models. Will not fit '16-'17 FXDLS, FLSS, FLSTFBS and FXSE or '13-'16 CVO Touring models with hydraulic actuated clutch, or '15-'16 FLHTCUL and FLHTKL, '14-'16 Touring and Trike models equipped with Screamin' Eagle A&S Clutch Kit P/N 37000026.



C. HEAVY DUTY CLUTCH SPRING FOR STOCK CLUTCH

D. SCREAMIN' EAGLE PERFORMANCE CLUTCH KIT

Performance Clutch Kit converts the 8-plate clutch to a 9-plate design. The surface area is increased by 13% and the spring rate is increased by 10% for a combination that can handle over 115 ft-lbs of torque at the crank, a 23% increase over the stock-rated capacity. Kit includes Kevlar® fiber-based friction discs and performance clutch spring.

38002-04 **\$199.95**

Fits '91-later XL and '94-'97 Evolution 1340-equipped models.



D. SCREAMIN' EAGLE PERFORMANCE CLUTCH KIT

E. SCREAMIN' EAGLE PERFORMANCE SLIPPER CLUTCH FOR VRSC™ MODELS

This clutch offers reduced lever effort and improved performance. The unique "slip and assist" ramp system opens the two halves of the clutch hub slightly during high loads to the drivetrain, allowing a moderate slip that reduces shock to the drivetrain during rapid downshifting. The resulting reduction in wheel hop allows maximum contact between the tire and the road in wet or slippery conditions. Clutch lever effort is also reduced by 20% in 1130cc and 30% on 1250cc applications.

37938-08KA **\$239.95**

Fits '02-'07 VRSC™ models.



E. SCREAMIN' EAGLE PERFORMANCE SLIPPER CLUTCH FOR VRSC MODELS

Street legal and/or street compliant statements refer to product meeting 50-State emissions and noise standards in the United States.

The street legal and/or street compliant statements may not apply to markets outside of the United States.

Notice: The prices appearing in this catalog are the manufacturer's suggested retail prices. Actual retail prices may vary.

SCREAMIN' EAGLE® 517

6-Speed Transmission

F. SCREAMIN' EAGLE® 6-SPEED TRANSMISSION AND GEAR SET

Designed from the ground up, the Screamin' Eagle® transmission incorporates many of the best Original Equipment features, like a late-style shifting mechanism and a newly designed "shift ring" system to make this the smoothest shifting Harley-Davidson® transmission available. The "shift ring" system is similar to the system used in the VRSC™ transmission and it slides on the shafts to mate into the gears. This eliminates sliding heavy gears to accomplish the shift and results in smooth, precise and light effort shifting. Sixth gear is a true overdrive, at a .89:1 ratio and the first five gears mimic today's proven 5-speed ratios. The overdrive feature allows you to run a lower engine RPM in sixth gear, at any given road speed. Lower RPM can result in lower vibration, longer engine life and smoother cruising. The Screamin' Eagle 6-Speed Transmission is available as a complete transmission or as a replacement gear set and can be matched with hydraulic or cable-operated clutch controls.

Screamin' Eagle 6-Speed Transmissions feature forged chrome "trap door," forged shifter forks and forged and precisely ground gears. No speedometer or exhaust mount modifications are required. Complete transmissions are ready to install into the chassis and the 6-Speed Gear Set Kits are designed to replace the stock gear set without removing the transmission. Gear Set Kits require slight modification (template included) to the Original Equipment transmission case and include all necessary installation hardware.

COMPLETE TRANSMISSION

33045-03A Black and Chrome. **\$2,799.95**
Fits '00-'06 Softail® models. Requires separate purchase of appropriate Side Cover Release Kit.

33137-04 Black and Chrome. **\$2,799.95**
Fits '02-'06 Touring models. Requires separate purchase of appropriate Side Cover Release Kit.

GEAR SET

33100-03A **\$2,099.95**
Fits '91-'94 and '96-'00 Dyna® and '90-'99 Softail models. Requires separate purchase of appropriate Side Cover Release Kit.

33101-03A **\$2,099.95**
Fits '90-'00 Touring models. Requires separate purchase of appropriate Side Cover Release Kit.

33102-03A **\$2,099.95**
Fits '00-'06 Softail and '01-'06 Touring models. Requires separate purchase of appropriate Side Cover Release Kit.

33103-03A **\$2,099.95**
Fits '01-'05 Dyna models. Requires separate purchase of appropriate Side Cover Release Kit.

Shown with:

SCREAMIN' EAGLE TRANSMISSION SIDE COVER FOR 6-SPEED TRANSMISSION

Includes unique side cover and clutch components required for installing a Screamin' Eagle 6-Speed Transmission.

38753-04A Hydraulic Clutch. **\$299.95**
Fits '99-'05 Dyna, '00-'06 Softail and '99-'06 Touring models equipped with Screamin' Eagle 6-Speed Transmission and Hydraulic Clutch. NOTE: If installing a Hydraulic Clutch on a previously installed Screamin' Eagle 6-Speed, separate purchase of the Clutch Release Cover Gasket P/N 35148-03 is required.

38752-04 Cable Clutch. **\$199.95**
Fits '91-'05 Dyna and '90-'06 Softail and Touring models equipped with Screamin' Eagle 6-Speed Transmission and cable-actuated clutch.

Street legal and/or street compliant statements refer to product meeting 50-State emissions and noise standards in the United States.

The street legal and/or street compliant statements may not apply to markets outside of the United States.

Notice: The prices appearing in this catalog are the manufacturer's suggested retail prices. Actual retail prices may vary.



The Screamin' Eagle 6-Speed Transmission has been tested and validated using the same rigorous procedures that Original Equipment transmissions are subjected to and is backed by a 12 or 24-month (depending on model year) unlimited mileage warranty when installed at the time of a new bike purchase.

F. SCREAMIN' EAGLE 6-SPEED TRANSMISSION AND GEAR SET (SHOWN WITH SCREAMIN' EAGLE TRANSMISSION SIDE COVER FOR 6-SPEED TRANSMISSION)

SHORT & LONGBLOCK PROGRAM

When it comes time to repower your motorcycle, the first step should be your local Harley® dealer. They can set you up with a replacement short block or long block engine that is manufactured from 100% new Original Equipment parts and subjected to the same rigorous testing as all Harley engines. Plus, all long block engines feature a one-year factory warranty and your original VIN stamped on the case.



SCREAMIN' EAGLE® 519

Shortblock Program

A. SHORTBLOCK ASSEMBLY

The perfect starting point for building the engine of your dreams. Engine shortblocks are manufactured and assembled on Harley-Davidson's main engine assembly line for exceptional quality and reliability. Shortblock cases, flywheels, bearings and rods are preassembled and ready for your custom build. Kit includes current spec Original Equipment cam plate, oil pump, cam drive components and the gaskets, seals and most of the hardware required to complete the engine and install it (not all components shown). You select your cylinders, heads, cams, covers and other top-end components. Choose one of the Screamin' Eagle® Stage kits to incorporate reliable performance and pick from our decorative engine covers to customize the look. Shortblock Assemblies are stamped with a new VIN number and include MSO (Manufacturers Statement of Origin). The MSO is for Domestic only. Kits ship directly from the factory within 3-5 days. Assembly comes stamped with a new VIN on Twin-Cam Kits.

Twin Cam Engine

16200070 Black 96CI/103CI. **\$2,100.00**
Fits '07-'17 Dyna® (except FXDLS), and '07-'16 Touring and Trike models (except CVO™).

16200071 Black 96CI/103CI. **\$2,370.00**
Fits '07-'17 Softail® models (except FLSS, FLSTFBS and CVO).

Milwaukee-Eight® Engine (not shown)

See your Dealer for details.



A. TWIN CAM SHORTBLOCK ASSEMBLY – DYNA AND TOURING



A. TWIN CAM SHORTBLOCK ASSEMBLY – SOFTAIL

NOTE: Replacement engines must be re-fitted with emission control devices and systems, appropriate for the vehicle model and model year in order to ensure emissions compliance. Failure to do so constitutes tampering under US EPA guidelines and can lead to substantial fines and penalties.

Legal for use on public roads only when installed in the specified models. Not legal for use on public roads when installed in models other than the ones specified and not eligible for the P&A 24-month warranty when installed in models other than the ones specified. Please see the Parts and Accessories warranty statement and your dealer for more information.

Street legal and/or street compliant statements refer to product meeting 50-State emissions and noise standards in the United States.

The street legal and/or street compliant statements may not apply to markets outside of the United States.

Notice: The prices appearing in this catalog are the manufacturer's suggested retail prices. Actual retail prices may vary.

HARLEY-DAVIDSON® LONGBLOCK PROGRAM

Your engine is the heart and soul of your Harley-Davidson® motorcycle. When the miles start to add up, a Harley-Davidson LongBlock can put the rumble back in your ride simply, quickly, and affordably.

WHY SHOULD I CONSIDER A LONGBLOCK? Unlike an engine rebuild from the repair shop down the street, the Harley-Davidson® LongBlock is manufactured from 100% new Original Equipment components, and is built to the latest factory specifications. Engine includes upgraded Screamin' Eagle® lefty crankcase bearing, Screamin' Eagle cam bearings and Screamin' Eagle performance tappets to handle higher stress loads and performance upgrades. In addition, '99-'06 LongBlocks are upgraded with late-model hydraulic cam tensioners, high-volume oil pump and billet cam plate. '07-'16 103CI and 110CI engines feature factory-installed Automatic Compression Releases.

WHAT DOES THE H-D® LONGBLOCK INCLUDE? The crankcase is pre-assembled with flywheels, connecting rods, bearings, seals, cylinders, pistons, rings, heads, valves, valve springs, tappets and pushrod covers. Also included and ready for Dealer installation are top end rocker arm supports, rocker arms and shafts, pushrods, and breathers. The LongBlock also includes cam support plate, cam plate bearings, cam and timing chain drive, hydraulic tensioners and all required gaskets and new hardware.

ARE UPGRADES AVAILABLE?* You can choose silver or black-highlighted engines to match your styling direction. Bikes originally equipped with Twin Cam 88® engines can upgrade to 95 or 103CI displacement, and Twin Cam 96™-equipped models can be repowered with 103 or 110CI engines, based on specific model fitment. Upgrades require model-specific ECM recalibration (sold separately). Only available in North America.

WHAT ELSE DO I NEED? LongBlock is sold without cam shafts, lower rocker boxes, upper rocker box covers, or cam cover. You have the option to re-install your current cams and covers, or select from a wide assortment of performance and custom engine cover options.

FAST AND EASY: Just take your Harley® motorcycle to your authorized dealership. They will remove the engine from the frame, ship the left crankcase half to Harley-Davidson, and in a short time, you will have a new LongBlock back, ready for the dealer to reinstall in your bike. Your engine retains its original Vehicle Identification Number (VIN) for easy title exchange and registration.

**Displacement upgrades are available for vehicles previously equipped with street compliant big bore kits only.*

Also available:

ENGINE COVER KITS

Finish your LongBlock engine installation in style. Kit includes 2 upper and lower rocker box covers and matching cam cover.

Fits '01-'17 Dyna®, '01-'17 Softail® and '01-'16 Touring (except '01 EFI Touring) and '09-'16 Trike models.

92500025	Chrome.	\$399.95
92500026	Gloss Black.	\$299.95
92500027	Wrinkle Black.	\$299.95



Available to fit:

'00-'06 Softail models.

16200087	Twin Cam 88® – Black.	\$4,475.00
16200088	Twin Cam 88 – Silver.	\$4,475.00

'01-'06 EFI Softail models.

16200093	Twin Cam 95 – Black.*	\$4,575.00
16200094	Twin Cam 95 – Silver.*	\$4,575.00

'05-'06 EFI Softail models.

16200097	Twin Cam 103™ – Black.*	\$5,000.00
16200098	Twin Cam 103 – Silver.*	\$5,000.00

'07-'11 Softail models.

16200101	Twin Cam 96™ – Black.	\$4,575.00
16200102	Twin Cam 96 – Silver.	\$4,575.00

'07-'17 Softail models.

16200104	Twin Cam 103 – Black.*	\$5,000.00
16200108	Twin Cam 110™ – Black.*	\$5,100.00
16200109	Twin Cam 110 – Granite.*	\$5,100.00

'99-'05 Dyna and '99-'06 Touring models.

16200085	Twin Cam 88 – Black.	\$3,850.00
16200086	Twin Cam 88 – Silver.	\$3,850.00

'04-'05 EFI Dyna and '99-'06 EFI Touring models.

16200091	Twin Cam 95 – Black.*	\$3,950.00
16200092	Twin Cam 95 – Silver.*	\$3,950.00

'03-'06 EFI Touring models.

16200095	Twin Cam 103 – Black.*	\$4,575.00
16200096	Twin Cam 103 – Silver.*	\$4,575.00

'06-'17 Dyna and '07-'11 Touring models.

16200099	Twin Cam 96 – Black.	\$4,050.00
16200100	Twin Cam 96 – Silver.	\$4,050.00

'07-'17 Dyna and '07-'16 Touring models (Includes ACR - Auto Compression Release).

16200103	Twin Cam 103 – Black.*	\$4,575.00
16200105	Twin Cam 110 – Black.*	\$4,700.00
16200106	Twin Cam 110 – Granite.*	\$4,700.00

'14-'16 Twin-Cooled™ Touring models.

16200162	Twin Cam 103 – Black.*	\$4,295.68
16200163	Twin Cam 110 – Black.*	\$4,500.48
16200164	Twin Cam 110 – Granite.*	\$4,500.48

Notice: The prices appearing in this catalog are the manufacturer's suggested retail prices. Actual retail prices may vary.



LONGBLOCK – '99-'06 MODELS (DYNA®/TOURING SHOWN)

High-Volume Oil Pump

Cam Chain

Cam Cover Gasket

Valve Cover Gaskets

Timing Chain & Gears

Billet Cam Support Plate

Rocker Arm Shafts

Rocker Arm Supports

Rocker Arms

Breathers

Cam Bearings

Pushrods

Bearing Support

Hydraulic Tensioners



LONGBLOCK – '07-'16 MODELS (DYNA/TOURING SHOWN)

High-Volume Oil Pump

Cam Chain

Cam Cover Gasket

Valve Cover Gaskets

Timing Chain & Gears

Cam Support Plate

Rocker Arm Shafts

Rocker Arm Supports

Rocker Arms

Breathers

Pushrods

Hydraulic Tensioners

ENGINE TRIM COLLECTIONS

Make It Your Own. Build a bike that fits your sense of style. To give your bike a clean and seamless appearance, select components from one of the Harley-Davidson® collections. You'll be one step closer to the look you've been dreaming about.

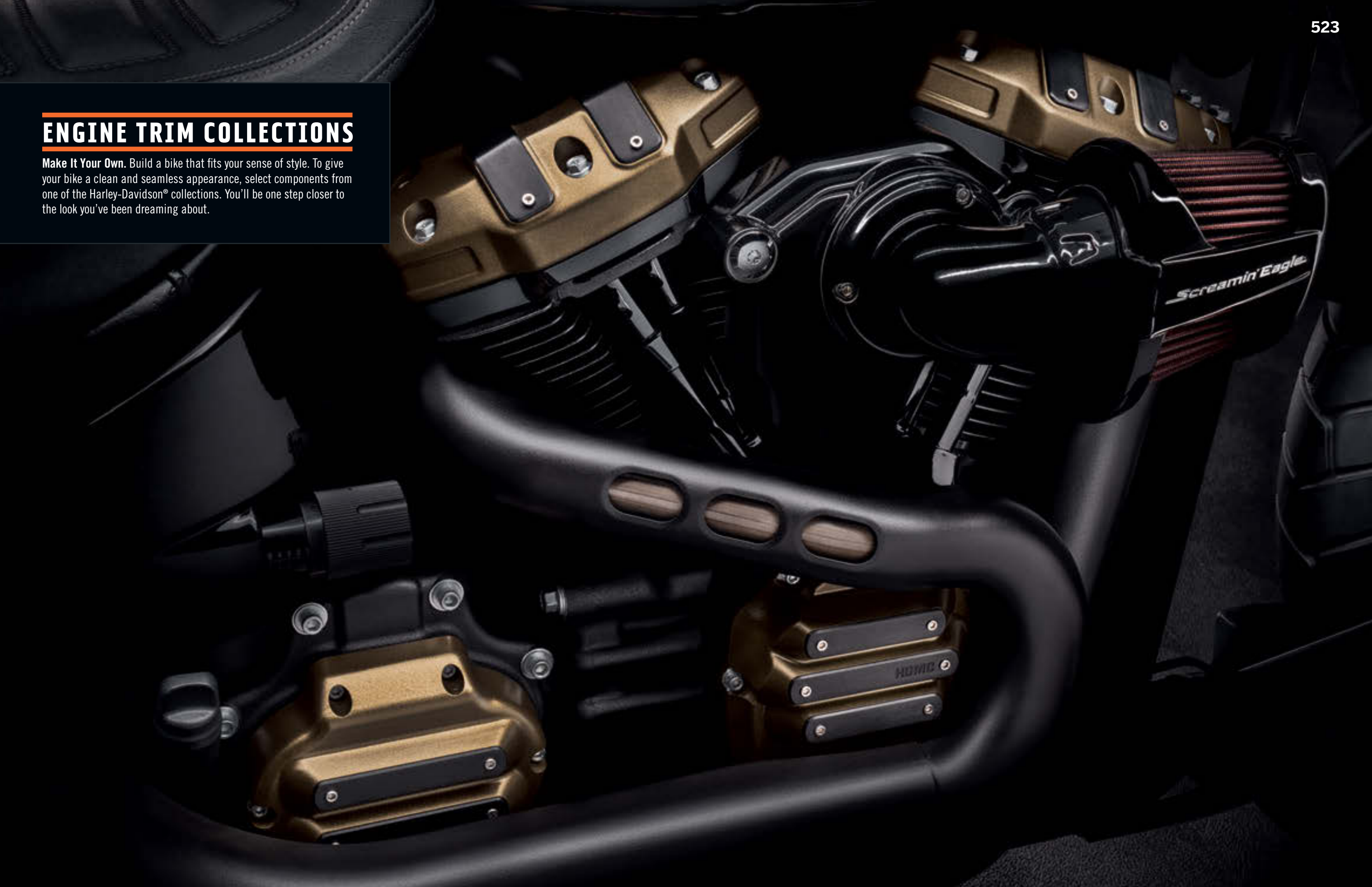

HARLEY-DAVIDSON® COLLECTIONS



DOMINION™ COLLECTION
Gloss Black Anodized
SEE PAGE 528



DOMINION COLLECTION
Bronze Powder Coated
SEE PAGE 529



DEFIANCE COLLECTION
Black
SEE PAGE 533



DEFIANCE COLLECTION
Black Machined
SEE PAGE 534



DEFIANCE COLLECTION
Chrome
SEE PAGE 535



KAHUNA™ COLLECTION
Gloss Black
SEE PAGE 536



KAHUNA COLLECTION
Chrome
SEE PAGE 537



BRASS COLLECTION
SEE PAGE 538



AIRFLOW COLLECTION
SEE PAGE 539

HARLEY-DAVIDSON® COLLECTIONS



**DARK CUSTOM™
COLLECTION**
SEE PAGE 540



**NUMBER ONE SKULL
COLLECTION**
SEE PAGE 541



**WILLIE G. SKULL
COLLECTION**
SEE PAGE 542



WILLIE G. SKULL COLLECTION
Black
SEE PAGE 543



**LIVE TO RIDE
COLLECTION**
SEE PAGE 544



**HARLEY-DAVIDSON®
MOTOR CO. COLLECTION**
SEE PAGE 545



**BURST
COLLECTION**
SEE PAGE 552



**EDGE CUT
COLLECTION**
SEE PAGE 592



**DIAMOND BLACK
COLLECTION**
SEE PAGE 600

DOMINION™ COLLECTION

The premium, leading-edge Dominion™ collection was created to take your bike to a new level of customization. This robust, but simple system is offered in gloss black anodized or bronze powder coated base components and features interchangeable accent pieces to kick your bike into high gear.



STEP 1 | SELECT DOMINION™ ENGINE COMPONENTS (GLOSS BLACK ANODIZED OR BRONZE POWDER COATED)

GLOSS BLACK ANODIZED - with Machined Aluminum Highlights

BRONZE POWDER COATED - with Machined Aluminum Highlights



STEP 2 | SELECT DOMINION FOOT CONTROLS (GLOSS BLACK ANODIZED OR BRONZE POWDER COATED)

GLOSS BLACK ANODIZED - with Brushed Black Inserts

BRONZE POWDER COATED - with Bronze Powder Coated Inserts

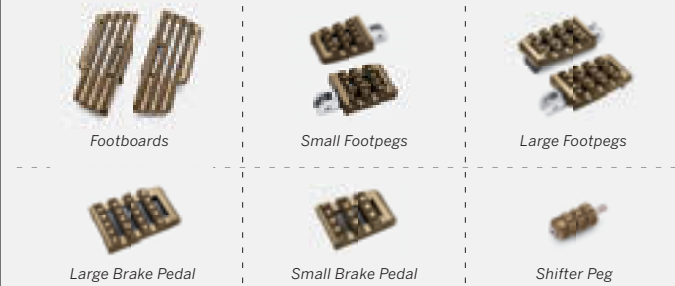
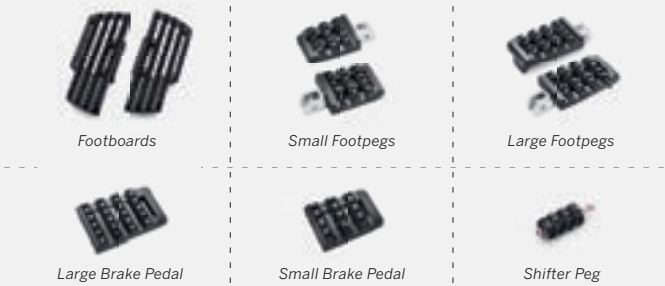

STEP 3 | SELECT DOMINION ACCENT COLOR (Brushed Black, Bronze Powder Coated, Brushed Orange Anodized, Brushed Black HDMC, Brushed Aluminum)

ENGINE COMPONENT INSERTS - Mix and Match

FOOT CONTROL INSERTS - Mix and Match



STEP 4 | SELECT ADDITIONAL DOMINION PRODUCTS TO COMPLETE THE LOOK

HAND GRIPS

MIRRORS

FUEL CAP

AXLE, FORK NUT, STEERING STEM COVERS



528 ENGINE TRIM

Milwaukee-Eight® Collections

A. DOMINION™ COLLECTION ENGINE TRIM – GLOSS BLACK

Express your bold, renegade attitude. This complete collection of engine covers lets you set your own styling direction. Crafted from aluminum, the Dominion™ Collection features a gloss black anodized finish with machined, raw aluminum surfaces. These surfaces can be left exposed or, they come ready to be filled with interchangeable brushed black, bronze powder-coated or brushed orange anodized inserts (sold separately) that allow you to create your own look. Socket head cap screws are included for added style.

25700722 Cam Cover. **\$249.95**
Fits '18-later Softail® and '17-later Touring and Trike models.

34800047 Transmission Side Cover. **\$199.95**
Fits '18-later Softail models (except FLDE, FLHC and FLHCS).

25700779 Upper Rocker Covers. **\$299.95**
Fits '18-later Softail and '17-later Touring and Trike models. Includes 2 covers.

25700768 Derby Cover. **\$159.95**
Fits '16-later Touring and Trike and '15-later FLHTCUL and FLHTKL models. Also fits '07-later Touring and Trike models equipped with Narrow-Profile Outer Primary Cover P/N 25700385 or 25700438.

25700965 Derby Cover. **\$159.95**
Fits '18-later FLSB and '19-later Softail models. Also fits '18 Softail models equipped with Narrow Profile Primary Cover P/Ns 25700900, 25700913, 25700937, 25700941, 25701039, 25701040 and 25701043.

25700825 Derby Cover. **\$159.95**
Fits '06-'17 Dyna®, '07-'18 Softail (except FLSB) and '07-'15 Touring and Trike (except FLHTCUL and FLHTKL and '07-'15 Touring and Trike models equipped with Narrow-Profile Outer Primary Cover P/N 25700385 or 25700438).

NEW



A. DOMINION COLLECTION ENGINE TRIM – GLOSS BLACK

NEW



A. DOMINION COLLECTION ENGINE TRIM – GLOSS BLACK

Notice: The prices appearing in this catalog are the manufacturer's suggested retail prices. Actual retail prices may vary.



NEW

ENGINE TRIM 529

Milwaukee-Eight® Collections

B. DOMINION™ COLLECTION ENGINE TRIM – BRONZE

Express your bold, renegade attitude. This complete collection of engine covers lets you set your own styling direction. Crafted from aluminum, the Dominion™ Collection features a bronze powder-coated finish with machined, raw aluminum surfaces. These surfaces can be left exposed or, they come ready to be filled with interchangeable brushed black, bronze powder-coated or brushed orange anodized inserts (sold separately) that allow you to create your own look. Socket head cap screws are included for added style.

25700777 Cam Cover. **\$249.95**

Fits '18-later Softail® and '17-later Touring and Trike models.

34800048 Transmission Side Cover. **\$199.95**

Fits '18-later Softail models (except FLDE, FLHC and FLHCS).

25700780 Upper Rocker Covers. **\$299.95**

Fits '18-later Softail and '17-later Touring and Trike models.

Includes 2 covers.

25700822 Derby Cover. **\$159.95**

Fits '16-later Touring and Trike and '15-later FLHTCUL and FLHTKL models. Also fits '07-later Touring and Trike models equipped with Narrow-Profile Outer Primary Cover P/N 25700385 or 25700438.

25700966 Derby Cover. **\$159.95**

Fits '18-later FLSB and '19-later Softail models. Also fits '18 Softail models equipped with Narrow Profile Primary Cover P/Ns 25700900, 25700913, 25700937, 25700941, 25701039, 25701040 and 25701043.

25700826 Derby Cover. **\$159.95**

Fits '06-'17 Dyna®, '07-'18 Softail (except FLSE) and '07-'15 Touring and Trike (except FLHTCUL and FLHTKL and '07-'15 Touring and Trike models equipped with Narrow-Profile Outer Primary Cover P/N 25700385 or 25700438).

B. DOMINION COLLECTION ENGINE TRIM – BRONZE



NEW

Model Family Fitment:

- V-ROD
- SPORTSTER
- DYNA
- SOFTAIL
- TOURING

B. DOMINION COLLECTION ENGINE TRIM – BRONZE

Notice: The prices appearing in this catalog are the manufacturer's suggested retail prices. Actual retail prices may vary.

530 ENGINE TRIM

Milwaukee-Eight® Engine

A. DOMINION™ COLLECTION INSERTS – LARGE

Make your bike a true custom of one. The Large Dominion™ Inserts allow you to customize and personalize Dominion Collection accessories, so your bike is truly one of a kind.

Fits '06-'17 Dyna®, '18-later Softail® and '17-later Touring and Trike models equipped with Dominion Derby, Cam, or Transmission Side Covers. Sold Individually.

61400598	Brushed Black.	\$19.95
61400602	Bronze.	\$19.95
61400606	Brushed Orange.	\$19.95
61400609	Brushed Black, HDMC.	\$24.95

B. DOMINION COLLECTION INSERTS – SMALL

Make your bike a true custom of one. The Small Dominion Inserts allow you to customize and personalize Dominion Collection accessories, so your bike is truly one of a kind.

Fits '06-'17 Dyna, '18-later Softail and '17-later Touring and Trike models equipped with Dominion Derby or Cam covers. Sold Individually.

61400599	Brushed Black.	\$19.95
61400603	Bronze.	\$19.95
61400607	Brushed Orange.	\$19.95

C. DOMINION COLLECTION INSERTS – ROCKER BOX

Make your bike a true custom of one. The Dominion Upper Rocker Box Inserts allow you to customize the top of your bike's engine case, making it a one-of-a-kind.

Fits '18-later Softail and '17-later Touring and Trike models equipped with Dominion Upper Rocker Box covers. Includes 4 inserts.

25700791	Brushed Black.	\$49.95
25700792	Bronze.	\$49.95
25700793	Brushed Orange.	\$49.95



A. DOMINION COLLECTION INSERTS – LARGE (BLACK HDMC SHOWN – MIDDLE INSERT)



A. DOMINION COLLECTION INSERTS – LARGE



B. DOMINION COLLECTION INSERTS – SMALL (ORANGE SHOWN – TOP AND BOTTOM)



B. DOMINION COLLECTION INSERTS – SMALL



C. DOMINION COLLECTION INSERTS – ROCKER BOX (BRONZE SHOWN)



C. DOMINION COLLECTION INSERTS – ROCKER BOX

Notice: The prices appearing in this catalog are the manufacturer's suggested retail prices. Actual retail prices may vary.



NEW

**D. DOMINION COLLECTION PRIMARY COVER – BLACK
(SHOWN WITH BRUSHED ORANGE INSERT)**



NEW

**D. DOMINION COLLECTION PRIMARY COVER – BRONZE
(SHOWN WITH BRUSHED BLACK INSERT)**



NEW

E. DOMINION COLLECTION OIL FILL INSERTS – OUTER PRIMARY COVER

ENGINE TRIM 531

Milwaukee-Eight® Engine

D. DOMINION™ OUTER PRIMARY COVER

Add visual interest and style to the primary side of your ride. Crafted from forged aluminum, the Dominion Collection™ Outer Primary Covers feature a gloss black anodized or bronze powder-coated finish. Match or complement other Dominion Collection Accessories when you cover the oil fill cavity with a Dominion Oil Fill Insert (required and sold separately). The Oil Fill Inserts are available in brushed aluminum, brushed black, bronze powder-coated or brushed orange anodized finishes to complement your styling direction.

Fits '18-later Softail® (except FXBB and FXLR). Requires separate purchase of Oil Fill Insert Kit P/Ns 25700804, 25700805, 25700806 or 25700807.

25700795	Gloss Black.	\$499.95
25700796	Bronze.	\$499.95

Fits '18-later FXBB and FXLR. Requires separate purchase of Oil Fill Insert Kit P/Ns 25700804, 25700805, 25700806 or 25700807.

25700851	Gloss Black.	\$499.95
25700850	Bronze.	\$499.95

E. DOMINION COLLECTION OIL FILL INSERT – OUTER PRIMARY

Required when installing a Dominion Collection Outer Primary Cover, these interchangeable brushed black, bronze powder-coated, brushed orange anodized, or aluminum inserts allow you to customize the Primary Cover to match your styling direction.

Fits '18-later Softail models equipped with Dominion Outer Primary Cover. Includes gasket and screws.

25700805	Brushed Black.	\$39.95
25700806	Bronze.	\$39.95
25700807	Brushed Orange.	\$39.95
25700804	Brushed Aluminum.	\$39.95

Model Family Fitment:

- V-ROD
- SPORTSTER
- DYNA
- SOFTAIL
- TOURING

Notice: The prices appearing in this catalog are the manufacturer's suggested retail prices. Actual retail prices may vary.

532 ENGINE TRIM

Milwaukee-Eight® Collections

A. GLOSS BLACK ENGINE COVER KIT – MILWAUKEE-EIGHT® POWERTRAIN

Upgrade your black and chrome Milwaukee-Eight® motor to the sinister look of gloss black. Manufactured from Original Equipment components, these richly finished engine covers start your bike on its journey to the dark side. Critical gasket surfaces are masked to provide a good sealing surface with the engine. The six-piece kit includes the primary cover, cam cover, upper rocker box covers, transmission side cover and transmission top cover. Rocker box lower housings, derby cover and timer cover are available separately.

Kit includes:

- Primary Cover
- Cam Cover
- Upper Rocker Box Covers (2)
- Transmission Side Cover with Insert
- Transmission Top Cover

92500059 Six Piece Engine Cover Kit. **\$699.95**
Fits '17-later Touring and Trike models.

B. MILWAUKEE-EIGHT ENGINE COVERS – GLOSS BLACK

These engine covers are the perfect start in converting your powertrain to an elegant tuxedo black look. Manufactured from Original Equipment components to ensure a perfect fit, these covers are coated with temperature-resistant paint to ensure a long-lasting finish, and critical surfaces are masked to provide good gasket seal. Complete the look with matching primary covers, rocker housings, rocker covers, cam covers and transmission covers (sold separately).

25700491 Primary Cover. **\$269.95**
Fits '17-later Touring and Trike models.

25700750 Primary Cover. **\$269.95**
Fits '18 Softail® models (except FLSB, FXBB and FXLR).

25700913 Primary Cover. **\$269.95**
Fits '18-later Softail models (except FXBB and FXLR). '18 models (except FLSB) require separate purchase of Softail Narrow Derby Cover and required gaskets.

25700467 Cam Cover. **\$144.95**
Fits '18-later Softail and '17-later Touring and Trike models.

25700520 Rocker Box Cover – Upper. **\$120.95**
Fits '18-later Softail and '17-later Touring and Trike models (2 required).

25700521 Rocker Box Cover – Lower. **\$119.95**
Fits '18-later Softail and '17-later Touring and Trike models (2 required).

25800055 Transmission Side Cover. **\$79.95**
Fits '17-later Touring and Trike models.

25800098 Transmission Side Cover **\$79.95**
Fits '18-later Softail models

34800031 Transmission Top Cover. **\$79.95**
Fits '18-later Softail and '17-later Touring and Trike models. '18-later Softail models require separate purchase of gasket P/N 25700453.

25700477 Derby Cover. **\$44.95**
Fits '16-later Touring and Trike, and '15-later FLHTCUL and FLHTKL models. Also fits '07-later Touring and Trike models equipped with Narrow-Profile Outer Primary Cover P/N 25700385 or 25700438.

25700971 Derby Cover. **\$54.95**
Fits '18-later FLSB and '19-later Softail models. Also fits '18 Softail models equipped with Narrow Profile Primary Cover P/Ns 25700900, 25700913, 25700937, 25700941, 25701039, 25701040 and 25701043.

25600098 Timer Cover. **\$25.95**
Fits '17-later Milwaukee-Eight engine-equipped models.

NOTE: Removing and installing engine covers may require purchase of new gaskets. See dealer for information.



A. GLOSS BLACK ENGINE COVER KIT – MILWAUKEE-EIGHT POWERTRAIN



B. MILWAUKEE-EIGHT ENGINE COVERS – GLOSS BLACK

Notice: The prices appearing in this catalog are the manufacturer's suggested retail prices. Actual retail prices may vary.

ENGINE TRIM 533

Milwaukee-Eight® Collections



C./D. DEFIANCE ENGINE TRIM – BLACK
(SHOWN WITH DEFIANCE VENTILATOR AIR CLEANER TRIM)



C. DEFIANCE COLLECTION – BLACK

Show your complete disregard for the rules. Defined by sweeping curves, this complete assortment of engine covers feature a rich tuxedo black finish that is the perfect complement to your sinister ride. The design incorporates deep longitudinal lines, and is finished with a contemporary H-D logo. Complete the look with gloss black primary, lower rocker boxes and transmission top covers (sold separately).

25700710 Cam Cover. **\$254.95**

Fits '18-later Softail® (except FLDE, FLHC and FLHCS) and '17-later Touring and Trike models. Does not fit FXDRS models equipped with Screamin' Eagle® Exhaust. Installation requires separate purchase of model-specific cam cover gasket.

25700712 Upper Rocker Covers. **\$369.95**

Fits '18-later Softail and '17-later Touring and Trike models. Installation requires separate purchase of model-specific rocker cover gaskets. Sold in pairs.

25800087 Transmission Side Cover. **\$159.95**

Fits '17-later Touring and Trike models.

25700572 Derby Cover. **\$159.95**

Fits '16-later Touring and Trike and '15-later FLTHCUL and FLHTKL models. Also fits '07-later Touring and Trike models equipped with Narrow-Profile Outer Primary Cover P/N 25700385 or 25700438.

25700963 Derby Cover. **\$159.95**

Fits '18-later FLSB and '19-later Softail models. Also fits '18 Softail models equipped with Narrow Profile Primary Cover P/Ns 25700900, 25700913, 25700937, 25700941, 25701039, 25701040 and 25701043.

25700705 Derby Cover. **\$159.95**

Fits '06-'17 Dyna®, '07-'18 Softail (except FLSB), '07-'15 Touring, and Trike (except '15 FLHTCUL and FLHTKL and '07-later Touring and Trike models equipped with Narrow-Profile Outer Primary Cover P/N 25700385 or 25700438). Does not fit with passenger footboards in the "medium" or "low" position when flipped up.

NOTE: Removing and installing engine covers may require purchase of new gaskets. See dealer for information.

D. DEFIANCE COLLECTION VENTILATOR AIR CLEANER TRIM – BLACK ANODIZED

This forged and machined Defiance Air Cleaner Trim kit adds a premium touch to the Milwaukee-Eight® Ventilator Air Cleaner. The billet-style band with deep longitudinal lines and H-D logo wraps the center section of the Ventilator Air Cleaner face plate for a contemporary look. Kit includes trim band and mounting hardware. Protective Rain Sock P/N 29400177 or 29762-09 is available separately.

61300769 Black Anodized. **\$134.95**

Fits '18-later Softail and '17-later Touring and Trike models equipped with Ventilator Air Cleaner P/N 29400298 or 29400299. Also fits '18-later Softail models with 114CI engines and '17-later CVO™ touring models with Original Equipment Ventilator Air Cleaner with separate purchase of Air Filter P/N 29400293.



C. DEFIANCE ENGINE TRIM – BLACK

Model Family Fitment:

- V-ROD
- SPORTSTER
- DYNA
- SOFTAIL
- TOURING

Notice: The prices appearing in this catalog are the manufacturer's suggested retail prices. Actual retail prices may vary.

534 ENGINE TRIM

Milwaukee-Eight® Collections

DEFIANCE COLLECTION ENGINE TRIM

The Milwaukee-Eight® engine is the centerpiece of the modern Harley-Davidson® motorcycle, so treat it to a unique contemporary look. These Defiance Collection engine covers incorporate a unique forward-thrusting design that blends a retro art-deco streamliner look with a modern contemporary twist. Designed side-by-side with the Original Equipment components, these exquisitely engineered cast and billet parts are machined to fit the bike perfectly. Available in your choice of chrome, gloss black or machine cut black finishes; you can select the look that defines your sense of style.

A. DEFIANCE COLLECTION – BLACK MACHINE CUT

Anything but traditional, this complete collection of engine covers refuses to conform to everyday norms. The sweeping aero curves define the look, and the rich contrasting finishes set the tone. The machine-cut Defiance Collection features deep grooves milled into the black anodized surface that exposes the shimmering aluminum below. Complete the look with gloss black primary, lower rocker boxes and transmission top covers (sold separately).

25700602 Cam Cover. **\$279.95**
Fits '18-later Softail® (except FLDE, FLHC and FLHCS) and '17-later Touring and Trike models. Does not fit FXDRS models equipped with Screamin' Eagle® Exhaust. Installation requires separate purchase of model-specific cam cover gasket.

25700604 Upper Rocker Covers. **\$399.95**
Fits '18-later Softail and '17-later Touring and Trike models. Installation requires separate purchase of model-specific rocker cover gaskets. Sold in pairs.

25800065 Transmission Side Cover. **\$174.95**
Fits '17-later Touring and Trike models.

25700573 Derby Cover. **\$174.95**
Fits '16-later Touring and Trike and '15-later FLTHCUL and FLHTKL models. Also fits '07-later Touring and Trike models equipped with Narrow-Profile Outer Primary Cover P/N 25700385 or 25700438.

25700964 Derby Cover. **\$174.95**
Fits '18-later FL5B and '19-later Softail models. Also fits '18 Softail models equipped with Narrow Profile Primary Cover P/Ns 25700900, 25700913, 25700937, 25700941, 25701039, 25701040 and 25701043.

25700704 Derby Cover. **\$174.95**
Fits '06-'17 Dyna®, '07-'18 Softail (except FL5B), '07-'15 Touring, and Trike (except '15 FLTHCUL and FLHTKL and '07-later Touring and Trike models equipped with Narrow-Profile Outer Primary Cover P/N 25700385 or 25700438). Does not fit with passenger footboards in the "medium" or "low" position when flipped up.

NOTE: Removing and installing engine covers may require purchase of new gaskets. See dealer for information.

B. DEFIANCE COLLECTION VENTILATOR AIR CLEANER TRIM – BLACK ANODIZED MACHINE CUT

This forged and machined Defiance Air Cleaner Trim kit adds a premium touch to the Milwaukee-Eight Ventilator Air Cleaner. The billet-style band with deep longitudinal lines and H-D logo wraps the center section of the Ventilator Air Cleaner face plate for a contemporary look. Kit includes trim band and mounting hardware. Protective Rain Sock P/N 29400177 or 29762-09 is available separately.

61300770 **\$149.95**
Fits '18-later Softail and '17-later Touring and Trike models equipped with Ventilator Air Cleaner P/N 29400298 or 29400299. Also fits '18-later Softail models with 114CI engines and '17-later CVO™ touring models with Original Equipment Ventilator Air Cleaner with separate purchase of Air Filter P/N 29400293.



A./B. DEFIANCE ENGINE TRIM – BLACK MACHINE CUT
(SHOWN WITH DEFIANCE VENTILATOR AIR CLEANER TRIM)



A. DEFIANCE ENGINE TRIM – BLACK MACHINE CUT

Notice: The prices appearing in this catalog are the manufacturer's suggested retail prices. Actual retail prices may vary.

ENGINE TRIM 535

Milwaukee-Eight® Collections



C./D. DEFIANCE ENGINE TRIM – CHROME
(SHOWN WITH DEFIANCE VENTILATOR AIR CLEANER TRIM)

C. DEFIANCE COLLECTION – CHROME

Dare to be bold. Dressed in luxurious chrome, this complete collection of engine covers raises the customization bar. Defined by sweeping curves and accented with deep longitudinal lines and a contemporary H-D logo, the Chrome Defiance Collection design imparts a feeling of forward motion to the bike's profile. Add the complete collection, or start with one component and build your custom ride.

25700661 Cam Cover. **\$254.95**

Fits '18-later Softail® (except FLDE, FLHC and FLHCS) and '17-later Touring and Trike models. Does not fit FXDRS models equipped with Screamin' Eagle® Exhaust. Installation requires separate purchase of model-specific cam cover gasket.

25700663 Upper Rocker Covers. **\$369.95**

Fits '18-later Softail and '17-later Touring and Trike models. Installation requires separate purchase of model-specific rocker cover gaskets. Sold in pairs.

25800063 Transmission Side Cover **\$159.95**

Fits '17-later Touring and Trike models.

25700571 Derby Cover. **\$159.95**

Fits '16-later Touring and Trike and '15-later FLTHCUL and FLHTKL models. Also fits '07-later Touring and Trike models equipped with Narrow-Profile Outer Primary Cover P/N 25700385 or 25700438.

25700962 Derby Cover. **\$159.95**

Fits '18-later FLSE and '19-later Softail models. Also fits '18 Softail models equipped with Narrow Profile Primary Cover P/Ns 25700900, 25700913, 25700937, 25700941, 25701039, 25701040 and 25701043.

25700703 Derby Cover. **\$159.95**

Fits '06-'17 Dyna®, '07-'18 Softail (except FLSE), '07-'15 Touring, and Trike (except '15 FLHTCUL and FLHTKL and '07-later Touring and Trike models equipped with Narrow-Profile Outer Primary Cover P/N 25700385 or 25700438). Does not fit with passenger footboards in the "medium" or "low" position when flipped up.

NOTE: Removing and installing engine covers may require purchase of new gaskets. See dealer for information.

D. DEFIANCE COLLECTION VENTILATOR AIR CLEANER TRIM – CHROME

This forged and machined Defiance Air Cleaner Trim kit adds a premium touch to the Milwaukee-Eight® Ventilator Air Cleaner. The billet-style band with deep longitudinal lines and H-D logo wraps the center section of the Ventilator Air Cleaner face plate for a contemporary look. Kit includes trim band and mounting hardware. Protective Rain Sock P/N 29400177 or 29762-09 is available separately.

61300768 **\$134.95**

Fits '18-later Softail and '17-later Touring and Trike models equipped with Ventilator Air Cleaner P/N 29400298 or 29400299. Also fits '18-later Softail models with 114CI engines and '17-later CVO™ touring models with Original Equipment Ventilator Air Cleaner with separate purchase of Air Filter P/N 29400293.



D. DEFIANCE ENGINE TRIM – CHROME

Model Family Fitment:

- V-ROD
- SPORTSTER
- DYNA
- SOFTAIL
- TOURING

Notice: The prices appearing in this catalog are the manufacturer's suggested retail prices. Actual retail prices may vary.

536 ENGINE TRIM

Derby, Timer & Air Cleaner Covers

A. KAHUNA™ COLLECTION ENGINE COVERS – GLOSS BLACK

Understated but powerful, The Kahuna™ Collection's rich, gloss black surface is interrupted by a powerful raised bridge that draws the eye from leading to trailing edge. A red Bar & Shield logo adds the finishing touch.

1. 25700887 Derby Cover. **\$99.95**

Fits '16-later Touring and Trike and '15-later FLHTCUL and FLHTKL models. Also fits '07-later Touring and Trike models equipped with Narrow-Profile Outer Primary Cover P/N 25700385 or 25700438.

2. 25700988 Derby Cover. **\$99.95**

Fits '06-'17 Dyna®, '07-'18 Softail® (except FLSB) and '07-'15 Touring and Trike (except FLHTCUL and FLHTKL and '07-'15 Touring and Trike models equipped with Narrow-Profile Outer Primary Cover P/N 25700385 or 25700438).

3. 25600109 Timer Cover. **\$34.95**

Fits '17-later Milwaukee-Eight® engine-equipped models.

4. 25600108 Timer Cover. **\$34.95**

Fits '99-'17 Twin Cam-equipped models.

5. 61300928 Air Cleaner Trim **\$54.95**

Fits '17-later Touring and Trike models with Original Equipment air cleaner cover. Does not fit CVO™ models.

6. 61300929 Air Cleaner Trim. **\$54.95**

Fits '16-'17 Softail (except FLSTFBS) and '14-'16 Touring and Trike models with Original Equipment Air Cleaner Cover. Does not fit CVO models.



A. KAHUNA COLLECTION DERBY COVER – GLOSS BLACK



A. KAHUNA COLLECTION – GLOSS BLACK

Notice: The prices appearing in this catalog are the manufacturer's suggested retail prices. Actual retail prices may vary.



B. KAHUNA COLLECTION DERBY COVER – CHROME

ENGINE TRIM 537

Derby, Timer & Air Cleaner Covers

B. KAHUNA™ COLLECTION ENGINE COVERS – CHROME

Understated but powerful, The Kahuna™ Collection's smooth, glass-like chrome surface is interrupted by a powerful raised bridge that draws the eye from leading to trailing edge. A red Bar & Shield logo adds the finishing touch.

1. 25700987 Derby Cover. **\$99.95**
Fits '16-later Touring and Trike and '15-later FLHTCUL and FLHTKL models. Also fits '07-later Touring and Trike models equipped with Narrow-Profile Outer Primary Cover P/N 25700385 or 25700438.

2. 25700888 Derby Cover. **\$99.95**
Fits '06-'17 Dyna®, '07-'18 Softail® (except FL5B) and '07-'15 Touring and Trike (except FLHTCUL and FLHTKL and '07-'15 Touring and Trike models equipped with Narrow-Profile Outer Primary Cover P/N 25700385 or 25700438).

3. 25600115 Timer Cover. **\$34.95**
Fits '17-later Milwaukee-Eight® engine-equipped models.

4. 25600114 Timer Cover. **\$34.95**
Fits '99-'17 Twin Cam-equipped models.

5. 61300991 Air Cleaner Trim. **\$54.95**
Fits '17-later Touring and Trike models with Original Equipment air cleaner cover. Does not fit CVO™ models.

6. 61301022 Air Cleaner Trim. **\$54.95**
Fits '16-'17 Softail (except FLSTFBS) and '14-'16 Touring and Trike models with Original Equipment Air Cleaner Cover. Does not fit CVO models.



B. KAHUNA COLLECTION – CHROME

Model Family Fitment:

- V-ROD
- SPORTSTER
- DYNA
- SOFTAIL
- TOURING

Notice: The prices appearing in this catalog are the manufacturer's suggested retail prices. Actual retail prices may vary.

538 ENGINE TRIM

Derby, Timer & Air Cleaner Covers

A. BRASS COLLECTION

The authentic alternative to the typical chrome-covered or blacked-out look, the Harley-Davidson® Brass Collection delivers a warm, hand-crafted look to your custom ride. These minimalistic living finish components make a garage-built styling statement and are the ideal addition to your stripped-down bobber or café motorcycle. Artistically manufactured from solid brass, these components feature a natural antique finish that will age and patina when exposed to the elements. Unlike bright polished and plated brass trim, these heritage-finished components are subtle additions to your ride and don't compete for attention with the rest of the bike. Brass Collection components are factory treated with wax to slow the aging process, and are shipped with cleaning and care instructions.

1. 25700515 Derby Cover. **\$179.95**
Fits '06-'17 Dyna®, '07-'18 Softail® (except FL5B), and '07-'15 Touring, and Trike (except FLHTCUL and FLHTKL and '07-'15 Touring and Trike models equipped with Narrow-Profile Outer Primary Cover P/N 25700385 or 25700438). Does not fit with passenger footboards in the "medium" or "low" position when flipped up.

1. 25700967 Derby Cover. **\$174.95**
Fits '18-later FL5B and '19-later Softail models. Also fits '18 Softail models equipped with Narrow Profile Primary Cover P/Ns 25700900, 25700913, 25700937, 25700941, 25701039, 25701040 and 25701043.

2. 25700517 Derby Cover. **\$179.95**
Fits '04-later XL and XR models.

3. 25600081 Timer Cover. **\$69.95**
Fits '18-later Softail and '17-later Touring and Trike models equipped with Milwaukee-Eight® engines.

4. 25600057 Timer Cover. **\$69.95**
Fits '99-'17 Twin Cam-equipped models.

5. 25600059 Timer Cover. **\$69.95**
Fits '04-later XL, XR and earlier models with horizontal holes on timer cover.

6. 61400339 Air Cleaner Trim. **\$119.95**
Fits Evolution® 1340 models, '99-'08 Dyna, '00-'15 Softail (except FLS, FLSS, FLST5B, and FXS) and '99-'13 Touring and Trike models equipped with oval-shaped Original Equipment air cleaner cover. Also fits models equipped with Screamin' Eagle® Round High-Flow Air Cleaner Kits with separate purchase of Rain Sock Kit P/N 28728-10 or Air Cleaner Trim Installation Kit P/N 12400158.



A. BRASS COLLECTION – DERBY COVER



A. BRASS COLLECTION

Notice: The prices appearing in this catalog are the manufacturer's suggested retail prices. Actual retail prices may vary.

ENGINE TRIM 539

Derby, Timer & Air Cleaner Covers



B. AIRFLOW COLLECTION – DERBY COVER

B. AIRFLOW COLLECTION

Shaped to cheat the wind. The polished and mirror-chromed Airflow Collection features a raised bridge with 3 laminar grooves that float over the recessed panels. The layered surfaces capture light and shadows, and frame the subtle black-filled Harley-Davidson signature. This complete collection sets the stage for your one-of-a-kind custom ride. Includes chrome-plated mounting hardware.

1. 25700505 Derby Cover. **\$79.95**

Fits '16-later Touring and Trike, and '15-later FLHTCUL and FLHTKL models. Also fits '07-later Touring and Trike models equipped with Narrow-Profile Outer Primary Cover P/N 25700385 or 25700438.

1. 25700969 Derby Cover. **\$79.95**

Fits '18-later FLSB and '19-later Softail® models. Also fits '18 Softail models equipped with Narrow Profile Primary Cover P/Ns 25700900, 25700913, 25700937, 25700941, 25701039, 25701040 and 25701043.

2. 25700504 Derby Cover. **\$79.95**

Fits '99-'17 Dyna®, '00-'18 Softail (except FLSB) and '99-'15 Touring and Trike models (except FLHTCUL, FLHTKL and '07-'15 Touring and Trike models equipped with Narrow-Profile Outer Primary Cover P/N 25700385 or 25700438).

Installation on '06-later Dyna, '07-'18 Softail and '07-'15 Touring and Trike models require separate purchase of Gasket P/N 25416-99C.

3. 25700506 Derby Cover. **\$79.95**

Fits '04-later XL models.

4. 25600099 Timer Cover. **\$29.95**

Fits '17-later Milwaukee-Eight® engine-equipped models.

5. 25600046 Timer Cover. **\$29.95**

Fits '99-'17 Twin Cam models.

6. 25600047 Timer Cover. **\$29.95**

Fits '04-later XL models.

7. 61400323 Air Cleaner Trim. **\$59.95**

Fits Evolution® 1340 models, '99-'08 Dyna, '00-'15 Softail (except FLS, FLSS, FLSTSB and FXS) and '99-'13 Touring and Trike models equipped with oval-shaped Original Equipment air cleaner cover. Also fits models equipped with Screamin' Eagle® Round High-Flow Air Cleaner Kits with separate purchase of Rain Sock Kit P/N 28728-10 or Air Cleaner Trim Installation Kit P/N 12400158.

8. 61300542 Air Cleaner Trim. **\$59.95**

Fits '16-'17 Softail (except FLSTFBS and FXSE) and '14-'16 Touring and Trike models with Original Equipment Air Cleaner Cover. Does not fit CVO™ models.



B. AIRFLOW COLLECTION

Model Family Fitment:

- V-ROD
- SPORTSTER
- DYNA
- SOFTAIL
- TOURING

Notice: The prices appearing in this catalog are the manufacturer's suggested retail prices. Actual retail prices may vary.

540 ENGINE TRIM

Derby, Timer & Air Cleaner Covers

A. DARK CUSTOM™ LOGO COLLECTION

The famous Harley-Davidson #1 logo with a sinister twist. Machined from billet aluminum, these covers feature domed surfaces that are polished and black anodized to a rich satin sheen, and then re-machined to expose the raw aluminum. The resulting high-contrast design complements both polished and painted engine finishes.

1. 25700434 Derby Cover – Billet. **\$149.95**
Fits '16-later Touring and Trike, and '15-later FLHTCUL and FLHTKL models. Also fits '07-later Touring and Trike models equipped with Narrow-Profile Outer Primary Cover P/N 25700385 or 25700438.

1. 25700960 Derby Cover. **\$144.95**
Fits '18-later FLSB and '19-later Softail® models. Also fits '18 Softail models equipped with Narrow Profile Primary Cover P/Ns 25700900, 25700913, 25700937, 25700941, 25701039, 25701040 and 25701043.

1. 25562-09 Derby Cover – Billet. **\$149.95**
Fits '99-'00 Evolution® 1340, '99-'17 Dyna®, '99-'18 Softail (except FLSB) and '99-'15 Touring and Trike models (except FLHTCUL, FLHTKL or '07-'15 Touring or Trike models with Narrow-Profile Outer Primary Cover P/N 25700385 or 25700438).

2. 25563-09 Derby Cover – Billet. **\$149.95**
Fits '04-later XL models.

3. 25600064 Timer Cover – Billet. **\$64.95**
Fits '17-later Milwaukee-Eight® engine-equipped models.

4. 32414-09 Timer Cover – Billet. **\$64.95**
Fits '99-'17 Twin Cam-equipped models.

5. 32415-09 Timer Cover – Billet. **\$64.95**
Fits '04-later XL, XR and earlier models with horizontal holes on timer cover.

6. 61300655 Air Cleaner Trim – Billet. **\$69.95**
Fits '17-later Touring and Trike models with Original Equipment air cleaner cover. Does not fit CVO™ models.

7. 61300057 Air Cleaner Trim – Billet. **\$114.95**
Fits Evolution® 1340 models, '99-'08 Dyna, '00-'15 Softail (except FLS, FLSS, FLSTSB and FXS) and '99-'13 Touring and Trike models with Original Equipment air cleaner cover. Also fits models equipped with Screamin' Eagle® Round High-Flow Air Cleaner Kits with separate purchase of Rain Sock Kit P/N 28728-10 or Air Cleaner Trim Installation Kit P/N 12400158.

8. 61300224 Air Cleaner Trim – Billet. **\$69.95**
Fits '16-'17 Softail (except FLSTFBS and FXSE) and '14-'16 Touring and Trike models with Original Equipment air cleaner cover. Does not fit CVO models.

9. 61300055 Air Cleaner Trim – Billet. **\$114.95**
Fits '04-later XL models with Original Equipment oval air cleaner cover.



A. DARK CUSTOM LOGO COLLECTION DERBY COVER

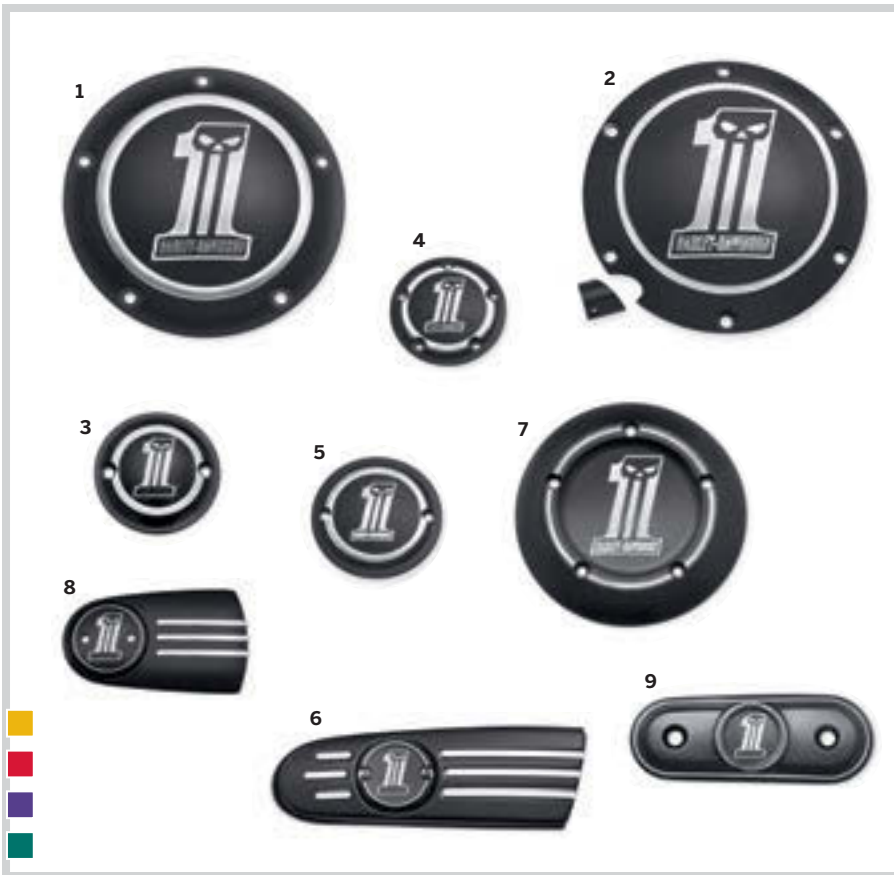

A. DARK CUSTOM LOGO COLLECTION

Notice: The prices appearing in this catalog are the manufacturer's suggested retail prices. Actual retail prices may vary.

ENGINE TRIM 541

Derby, Timer & Air Cleaner Covers



B. NUMBER ONE SKULL COLLECTION DERBY COVER

B. NUMBER ONE SKULL COLLECTION

The sinister Harley-Davidson #1 Skull logo dresses for a night on the town. This complete die-cast aluminum collection has been polished and chrome-plated to a brilliant shine, then finished with a contrasting black-filled Dark Custom Skull logo. The black-filled race track stripe and recessed hardware pockets provide added depth and dimension. Includes chrome-plated mounting hardware.

- | | | |
|--|-----------------------|-----------------|
| 1. 25700435 | Derby Cover – Billet. | \$139.95 |
| Fits '16-later Touring and Trike, and '15-later FLHTCUL and FLHTKL models. Also fits '07-later Touring and Trike models equipped with Narrow-Profile Outer Primary Cover P/N 25700385 or 25700438. | | |
| 1. 25331-10 | Derby Cover. | \$74.95 |
| Fits '99-'00 Evolution® 1340, '99-'17 Dyna®, '99-'18 Softail® (except FLSB) and '99-'15 Touring and Trike models (except FLHTCUL, FLHTKL or '07-'15 Touring or Trike models with Narrow-Profile Outer Primary Cover P/N 25700385 or 25700438). | | |
| 2. 25333-10 | Derby Cover. | \$74.95 |
| Fits '04-later XL models. | | |
| 3. 25600065 | Timer Cover. | \$28.95 |
| Fits '17-later Milwaukee-Eight® engine-equipped models. | | |
| 4. 32519-10 | Timer Cover. | \$28.95 |
| Fits '99-'17 Twin Cam-equipped models. | | |
| 5. 32520-10 | Timer Cover. | \$28.95 |
| Fits '04-later XL, XR and earlier models with horizontal holes on timer cover. | | |
| 6. 61300657 | Air Cleaner Trim. | \$54.95 |
| Fits '17-later Touring and Trike models with Original Equipment air cleaner cover. Does not fit CVO™ models. | | |
| 7. 27956-10 | Air Cleaner Trim. | \$49.95 |
| Fits Evolution® 1340 models, '99-'08 Dyna, '00-'15 Softail (except FLS, FLSS, FLSTSB and FXS) and '99-'13 Touring and Trike models with Original Equipment air cleaner cover. Also fits models equipped with Screamin' Eagle® Round High-Flow Air Cleaner Kits with separate purchase of Rain Sock Kit P/N 28728-10 or Air Cleaner Trim Installation Kit P/N 12400158. | | |
| 8. 61300218 | Air Cleaner Trim. | \$49.95 |
| Fits '16-'17 Softail (except FLSTFBS and FXSE) and '14-'16 Touring and Trike models with Original Equipment air cleaner cover. Does not fit CVO models. | | |
| 9. 60826-11 | Transmission Trim. | \$25.95 |
| Fits '11-'16 models equipped with 103CI Twin Cam engine option. | | |



B. NUMBER ONE SKULL COLLECTION

Model Family Fitment:

- | | | |
|--|--|---|
| V-ROD | SPORTSTER | DYNA |
| SOFTAIL | TOURING | |

Notice: The prices appearing in this catalog are the manufacturer's suggested retail prices. Actual retail prices may vary.

542 ENGINE TRIM

Derby, Timer & Air Cleaner Covers

A. WILLIE G SKULL COLLECTION

Add a little attitude to your ride. Styled to complement Harley-Davidson® Skull accessory items, the menacing raised skull with black-filled eyes leaps from a field of chrome. The surrounding Harley-Davidson Motorcycles script is the perfect finishing touch. This complete collection of engine covers dresses your bike for a true custom look.

1. 25700469 Derby Cover. **\$69.95**
Fits '16-later Touring and Trike, and '15-later FLHTCUL and FLHTKL models. Also fits '07-later Touring and Trike models equipped with Narrow-Profile Outer Primary Cover P/N 25700385 or 25700438.

1. 25700958 Derby Cover. **\$69.95**
Fits '18-later FLSB and '19-later Softail® models. Also fits '18 Softail models equipped with Narrow Profile Primary Cover P/Ns 25700900, 25700913, 25700937, 25700941, 25701039, 25701040 and 25701043.

1. 25441-04A Derby Cover. **\$64.95**
Fits '99-'00 Evolution® 1340, '99-'17 Dyna®, '99-'18 Softail (except FLSB) and '99-'15 Touring and Trike models (except FLHTCUL, FLHTKL or '07-'15 Touring or Trike models with Narrow-Profile Outer Primary Cover P/N 25700385 or 25700438).

2. 25440-04A Derby Cover. **\$64.95**
Fits '04-later XL and XR models. Includes chrome-plated stainless steel mounting hardware.

3. 25600066 Timer Cover. **\$28.95**
Fits '17-later Milwaukee-Eight® engine-equipped models.

4. 32975-04A Timer Cover. **\$28.95**
Fits '99-'17 Twin Cam-equipped models. Includes chrome-plated stainless steel mounting hardware.

5. 32972-04A Timer Cover. **\$28.95**
Fits '04-later XL, XR and earlier models with horizontal holes on timer cover. Includes chrome-plated stainless steel mounting hardware.

6. 61300654 Air Cleaner Trim. **\$54.95**
Fits '17-later Touring and Trike models with Original Equipment air cleaner cover. Does not fit CVO™ models.

7. 29417-04 Air Cleaner Trim. **\$49.95**
Fits Evolution 1340 models, '99-'08 Dyna, '00-'15 Softail (except FLS, FLSS, FLSTSB and FXS) and '99-'13 Touring and Trike models with Original Equipment air cleaner cover. Also fits models equipped with Screamin' Eagle® Round High-Flow Air Cleaner Kits with separate purchase of Rain Sock Kit P/N 28728-10 or Air Cleaner Trim Installation Kit P/N 12400158.

8. 61300217 Air Cleaner Trim. **\$49.95**
Fits '16-'17 Softail (except FLSTFBS and FXSE) and '14-'16 Touring and Trike models with Original Equipment air cleaner cover. Does not fit CVO™ models.

9. 29416-04 Air Cleaner Trim. **\$44.95**
Fits '04-later XL models with Original Equipment oval air cleaner cover.



A. WILLIE G SKULL COLLECTION DERBY COVER – CHROME



A. WILLIE G SKULL COLLECTION – CHROME

Notice: The prices appearing in this catalog are the manufacturer's suggested retail prices. Actual retail prices may vary.



NEW

B. WILLIE G SKULL COLLECTION DERBY COVER – BLACK

ENGINE TRIM 543

Derby, Timer & Air Cleaner Covers

B. WILLIE G SKULL COLLECTION ENGINE TRIM – BLACK

Penned at the hand of Willie G, the famous Skull Collection makes a shift to the dark side. Completely drenched in black, the raised skull and surrounding Harley-Davidson Motorcycle script adds a subtle ominous touch to your ride. The finish easily coexists alongside gloss black or wrinkle black surfaces. The complete collection of components includes matching black hardware.

- 1. 25700740** Derby Cover. **\$69.95**
Fits '16-later Touring and Trike and '15-later FLHTCUL and FLHTKL models. Also fits '07-later Touring and Trike models equipped with Narrow-Profile Outer Primary Cover P/N 25700385 or 25700438.

- 1. 25700976** Derby Cover. **\$59.95**
Fits '18-later FLSB and '19-later Softail® models. Also fits '18 Softail models equipped with Narrow Profile Primary Cover P/Ns 25700900, 25700913, 25700937, 25700941, 25701039, 25701040 and 25701043.

- 1. 25700742** Derby Cover. **\$59.95**
Fits '99-'17 Dyna®, '00-'18 Softail (except FLSB) and '99-'15 Touring and Trike models (except '15 FLHTCUL and FLHTKL and '07-'15 Touring and Trike models equipped with Narrow-Profile Outer Primary Cover P/N 25700385 or 25700438). Installation on '06-'17 Dyna and '07-later Softail, and '07-'15 Touring and Trike models requires separate purchase of Gasket P/N 25416-99C.

- 2. 25700744** Derby Cover. **\$64.95**
Fits '04-later XL and XR models.

- 3. 25600085** Timer Cover. **\$28.95**
Fits '17-later Milwaukee-Eight® engine-equipped models.

- 4. 25600087** Timer Cover. **\$28.95**
Fits '99-'17 Twin Cam models.

- 5. 25600089** Timer Cover. **\$28.95**
Fits '04-later XL, XR and earlier models with horizontal holes on timer cover.

- 6. 29400345** Air Cleaner Trim. **\$49.95**
Fits '17-later Touring and Trike models with Original Equipment wedge shaped air cleaner cover.

- 7. 29400366** Air Cleaner Trim. **\$49.95**
Fits Evolution® 1340 models, '99-'08 Dyna, '00-'15 Softail (except FLS, FLSS, FLSTSB, and FXS) and '99-'13 Touring and Trike models equipped with oval-shaped Original Equipment air cleaner cover. Also fits models equipped with Screamin' Eagle® Round High-Flow Air Cleaner Kits with separate purchase of Rain Sock Kit P/N 28728-10 or Air Cleaner Trim Installation Kit P/N 12400158.

- 8. 29400339** Air Cleaner Trim. **\$28.95**
Fits '16-'17 Softail (except FLSTFBS and FXSE) and '14-'16 Touring and Trike models with Original Equipment air cleaner cover. Does not fit CVO™ models.

- 9. 29400341** Air Cleaner Trim. **\$43.95**
Fits '04-later XL models (except XL1200V) equipped with Original Equipment oval air cleaner cover.



NEW

B. WILLIE G SKULL COLLECTION – BLACK

Model Family Fitment:

- V-ROD
- SPORTSTER
- DYNA
- SOFTAIL
- TOURING

Notice: The prices appearing in this catalog are the manufacturer's suggested retail prices. Actual retail prices may vary.

544 ENGINE TRIM

Derby, Timer & Air Cleaner Covers

A. HARLEY-DAVIDSON® LIVE TO RIDE COLLECTION – GOLD

Live To Ride, Ride to Live. It has become the motto of the Harley-Davidson nation, accompanying riders over millions of miles of travel. This collection is a tribute to that way of life.

1. 25700472 Derby Cover. **\$74.95**
Fits '16-later Touring and Trike, and '15-later FLHTCUL and FLHTKL models. Also fits '07-later Touring and Trike models equipped with Narrow-Profile Outer Primary Cover P/N 25700385 or 25700438.

2. 25700961 Derby Cover. **\$74.95**
Fits '18-later FLSB and '19-later Softail® models. Also fits '18 Softail models equipped with Narrow Profile Primary Cover P/Ns 25700900, 25700913, 25700937, 25700941, 25701039, 25701040 and 25701043.

1. 25340-99A Derby Cover. **\$69.95**
Fits '99-'00 Evolution® 1340, '99-'17 Dyna®, '99-'18 Softail (except FLSB) and '99-'15 Touring and Trike models (except FLHTCUL, FLHTKL or '07-'15 Touring or Trike models with Narrow-Profile Outer Primary Cover P/N 25700385 or 25700438).

2. 25127-04A Derby Cover. **\$69.95**
Fits '04-later XL and XR models. Includes chrome-plated stainless steel mounting hardware.

3. 25600067 Timer Cover. **\$37.95**
Fits '17-later Milwaukee-Eight® engine-equipped models.

4. 32689-99A Timer Cover. **\$36.95**
Fits '99-'17 Twin Cam-equipped models. Includes chrome-plated stainless steel mounting hardware.

5. 32585-90T Timer Cover. **\$37.95**
Fits models with vertical mounting holes.

32581-90TB Timer Cover. (not shown) **\$37.95**
Fits '04-later XL, XR and earlier models with horizontal holes on timer cover. Includes chrome-plated stainless steel mounting hardware.

6. 61300656 Air Cleaner Trim. **\$59.95**
Fits '17-later Touring and Trike models with Original Equipment air cleaner cover. Does not fit CVO™ models.

7. 29328-99 Air Cleaner Trim. **\$49.95**
Fits Evolution 1340 models, '99-'08 Dyna, '00-'15 Softail (except FLS, FLSTSB and FXS) and '99-'13 Touring and Trike models with Original Equipment air cleaner cover. Also fits models equipped with Screamin' Eagle® Round High-Flow Air Cleaner Kits with separate purchase of Rain Sock Kit P/N 28728-10 or Air Cleaner Trim Installation Kit P/N 12400158.

8. 61400455 Air Cleaner Trim – Center Bolt. **\$59.95**
Fits '18-later FLDE, FLHC, FLHCS, FLSL, and FXLR models with Original Equipment center bolt air cleaner cover.

9. 61300220 Air Cleaner Trim. **\$59.95**
Fits '16-'17 Softail (except FLSTFBS and FXSE) and '14-'16 Touring and Trike models with Original Equipment air cleaner cover. Does not fit CVO models.

10. 29823-04 Air Cleaner Trim. **\$44.95**
Fits '04-later XL models with Original Equipment oval air cleaner.

11. 61400025 Transmission End Cover Trim. **\$31.95**
Fits '11-'16 Touring and Trike models equipped with 103CI Twin Cam engine option.



A. HARLEY-DAVIDSON LIVE TO RIDE DERBY COVER – GOLD

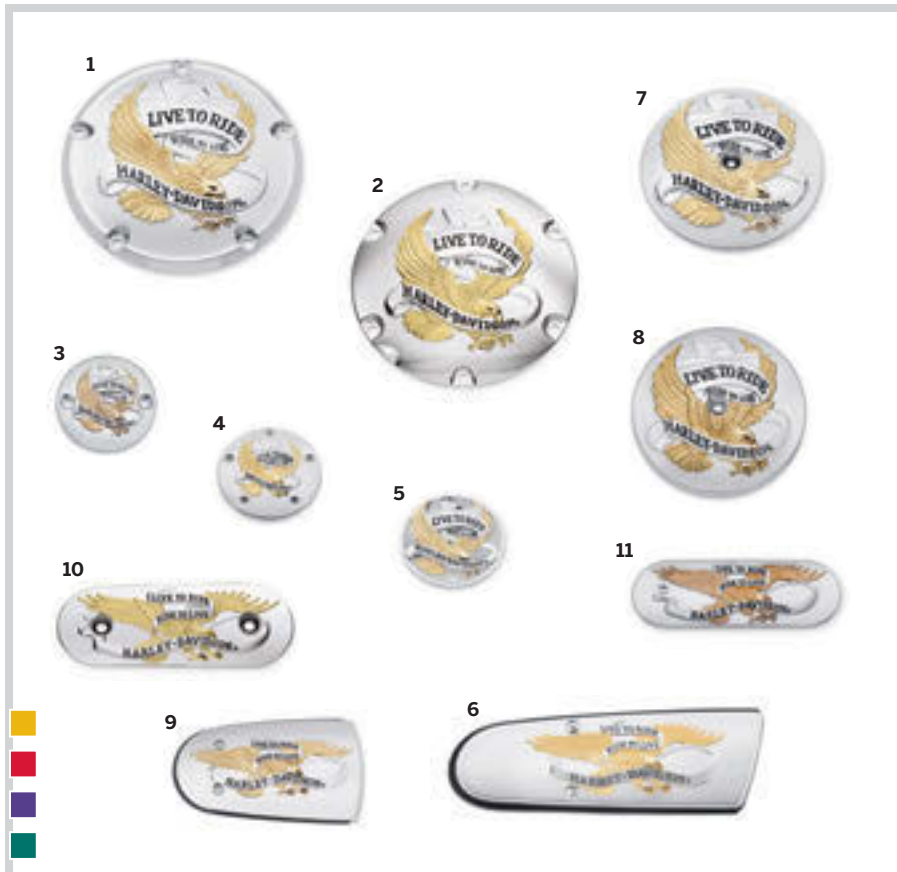

A. HARLEY-DAVIDSON LIVE TO RIDE COLLECTION – GOLD

Notice: The prices appearing in this catalog are the manufacturer's suggested retail prices. Actual retail prices may vary.

ENGINE TRIM 545

Derby, Timer & Air Cleaner Covers

B. HARLEY-DAVIDSON® MOTOR CO. COLLECTION

This collection personifies Harley style. It had better, because we put our name on it – The Harley-Davidson® Motor Co. Collection.

1. 25700476 Derby Cover. **\$54.95**
Fits '16-later Touring and Trike, and '15-later FLHTCUL and FLHTKL models. Also fits '07-later Touring and Trike models equipped with Narrow-Profile Outer Primary Cover P/N 25700385 or 25700438.

1. 25700959 Derby Cover. **\$54.95**
Fits '18-later FLSB and '19-later Softail® models. Also fits '18-later Softail models equipped with Narrow Profile Primary Cover P/Ns 25700900, 25700913, 25700937, 25700941, 25701039, 25701040 and 25701043.

1. 25338-99A Derby Cover. **\$49.95**
Fits '99-'00 Evolution® 1340, '99-'17 Dyna®, '99-'18 Softail (except FLSB) and '99-'15 Touring and Trike models (except FLHTCUL, FLHTKL or '07-'15 Touring or Trike models with Narrow-Profile Outer Primary Cover P/N 25700385 or 25700438).

2. 25130-04A Derby Cover. **\$49.95**
Fits '04-later XL and XR models. Includes chrome-plated stainless steel mounting hardware.

3. 25600068 Timer Cover. **\$28.95**
Fits '17-later Milwaukee-Eight® engine-equipped models.

4. 32047-99A Timer Cover. **\$28.95**
Fits '99-'17 Twin Cam-equipped models. Includes chrome-plated stainless steel mounting hardware.

5. 32668-98A Timer Cover. **\$25.95**
Fits '04-later XL, XR and earlier models with horizontal holes on timer cover. Includes chrome-plated stainless steel mounting hardware.

6. 61300658 Air Cleaner Trim. **\$54.95**
Fits '17-later Touring and Trike models with Original Equipment air cleaner cover. Does not fit CVO™ models.

7. 61300254 Air Cleaner Trim. **\$49.95**
Fits '16-'17 Softail (except FLSTFBS and FXSE) and '14-'16 Touring and Trike models with Original Equipment air cleaner cover. Does not fit CVO models.

8. 61300792 Air Cleaner Trim – Center Bolt. **\$49.95**
Fits '18-later FLDE, FLHC, FLHCS, FLSL, and FXLR models with Original Equipment center bolt air cleaner cover.



B. HARLEY-DAVIDSON MOTOR CO. COLLECTION DERBY COVER



B. HARLEY-DAVIDSON MOTOR CO. COLLECTION

Model Family Fitment:

- V-ROD
- SPORTSTER
- DYNA
- SOFTAIL
- TOURING

Notice: The prices appearing in this catalog are the manufacturer's suggested retail prices. Actual retail prices may vary.

546 ENGINE TRIM

Derby, Timer & Air Cleaner Covers

A. CLASSIC CHROME COVERS

From the design philosophy of less is more, we bring you this collection of basic chrome accessories, which provides a clean, custom look that is guaranteed to turn heads.

1. 25700388 Derby Cover. **\$64.95**
Fits '16-later Touring and Trike, and '15-later FLHTCUL and FLHTKL models. Also fits '07-later Touring and Trike models equipped with Narrow-Profile Outer Primary Cover P/N 25700385 or 25700438.

1. 60668-99 Derby Cover. (not shown) **\$64.95**
Fits '99-'05 Dyna® and '99-'06 Softail® and Touring models.

1. 60766-06 Derby Cover. (not shown) **\$64.95**
Fits '06-'17 Dyna and '07-'18 Softail (except FLSB), '07-'15 Touring and Trike models (except FLHTCUL, FLHTKL or '07-'15 Touring or Trike models equipped with Narrow-Profile Outer Primary Cover P/N 25700385 or 25700438). Does not fit with passenger footboards in the "medium" or "low" position when flipped up.

2. 34760-04 Derby Cover. **\$69.95**
Fits '04-later XL models.

3. 32584-88TA Timer Cover. **\$25.95**
Fits '04-later XL, XR and earlier models with horizontal holes on timer cover. Includes chrome-plated stainless steel mounting hardware.

4. 32679-99A Timer Cover. **\$25.95**
Fits Twin Cam-equipped models. Includes chrome-plated stainless steel mounting hardware.

5. 25600097 Timer Cover. **\$25.95**
Fits '17-later Milwaukee-Eight® engine-equipped models.

34761-04A Chain Inspection Cover. (not shown) **\$24.95**
Fits '04-later XL models.

6. 60529-90A Chain Inspection Cover. **\$89.95**
Fits '91-'05 Dyna models (except FXDWG).

7. 60572-86 Chain Inspection Cover. **\$49.95**
Fits '93-'05 FXDWG and '86-'06 FLST, FXST and FXSTS models.

8. 60670-85A Chain Inspection Cover. **\$54.95**
Fits '85-'06 Touring models.



A. CLASSIC CHROME COVERS

B. BLACK FIN COLLECTION

Finish the sinister black look of your motorcycle with the Black Fin Collection from Harley-Davidson. The raised horizontal lines on these die-cast covers echo the traditional cylinder fin look, and the wrinkle black finish is a perfect match for the blacked-out primary, cam cover and Finned Headbolt Bridge Kit.

1. 25454-01 Derby Cover. **\$43.95**
Fits '99-'00 Evolution® 1340, '99-'17 Dyna, '99-'18 Softail (except FLSB) and '99-'15 Touring and Trike models (except FLHTCUL, FLHTKL or '07-'15 Touring or Trike models with Narrow-Profile Outer Primary Cover P/N 25700385 or 25700438).

2. 25600142 Timer Cover. **\$25.95**
Fits '17-later Milwaukee-Eight engine-equipped models.

3. 32677-01 Timer Cover. **\$25.95**
Fits '99-'17 Twin Cam-equipped models.



B. BLACK FIN COLLECTION

C. BLACK DERBY COVERS

Available in your choice of wrinkle black or gloss black finish, these simple Derby Covers add a finishing touch to your blacked-out engine.

Fits '06-'17 Dyna and '07-'18 Softail (except FLSB), and '07-'15 Touring and Trike models (except FLHTCUL, FLHTKL or '07-'15 Touring or Trike models equipped with Narrow-Profile Outer Primary P/N 25700385 or 25700438). Does not fit with passenger footboards in the "medium" or "low" position when flipped up.

60713-07 Wrinkle Black. **\$44.95**

25700020 Gloss Black. **\$39.95**

Fits '16-later Touring and Trike, and '15-later FLHTCUL and FLHTKL models. Also fits '07-later Touring and Trike models equipped with Narrow-Profile Outer Primary Cover P/N 25700385 or 25700438.

25700477 Gloss Black. **\$44.95**

Fits '99-'05 Dyna and '99-'06 Softail and Touring models.

60713-99 Wrinkle Black. **\$44.95**

Fits '04-later XL models.

34790-05 Wrinkle Black. **\$39.95**



C. BLACK DERBY COVERS

Notice: The prices appearing in this catalog are the manufacturer's suggested retail prices. Actual retail prices may vary.

ENGINE TRIM 547

Engine Covers –Milwaukee-Eight®

NEW



D. NARROW-PROFILE PRIMARY COVERS – FORWARD CONTROLS

D. NARROW-PROFILE PRIMARY COVERS – FORWARD CONTROLS

Shaped to slim the bike's left side profile, this Narrow-Profile Primary Cover provides short-limbed riders a straight leg path to the pavement. Original Equipment on '19-later Softail® models.

Fits '18-later Softail models (except FXBB and FXLR). '18 models (except FLSB) require separate purchase of Softail Narrow Derby Cover and required gaskets.

1. 25700900	Chrome.	\$269.95
2. 25700913	Gloss Black.	\$269.95
3. 25701039	Polished.	\$249.95
4. 25701040	Satin Chrome.	\$269.95
5. 25701043	Wrinkle Black.	\$269.95

Also available:

Fits '18-later FXBB and FXLR models. '18 models require separate purchase of Softail Narrow Derby Cover and required gaskets.

25700937	Chrome.	\$269.95
25700941	Wrinkle Black.	\$269.95

E. OE STYLE NARROW-PROFILE DERBY COVERS – '19-LATER SOFTAIL®

Fits '18-later FLSB and '19-later Softail models. Also fits '18 Softail models equipped with Narrow Profile Primary Cover P/Ns 25700900, 25700913, 25700937, 25700941, 25701039, 25701040 and 25701043.

1. 25700934	Polished.	\$49.95
2. 25700973	Chrome.	\$54.95
3. 25700970	Black Denim.	\$54.95
4. 25700971	Gloss Black.	\$54.95
5. 25700972	Wrinkle Black.	\$54.95
6. 25700968	Black Fin.	\$43.95

More derby covers for Narrow-Profile Primary Covers can be found on pages 536-544 in the collections pages.

NEW



E. OE STYLE NARROW-PROFILE DERBY COVERS – '19-LATER SOFTAIL

Model Family Fitment:

 V-ROD	 SPORTSTER	 DYNA
 SOFTAIL	 TOURING	

Notice: The prices appearing in this catalog are the manufacturer's suggested retail prices. Actual retail prices may vary.

548 ENGINE TRIM

Engine Covers – Milwaukee-Eight®

A. INNER PRIMARY COVER TRIM

Get the look of a custom inner primary cover without tearing apart the drive train. Designed to wrap the top surface of the wrinkle-painted inner primary cover, this die-cast shell provides a beefy finished look to the engine cases. Easy to install, the cover is secured with the outer primary hardware, and held in place at multiple points for quiet operation. Available in your choice of brilliant chrome or gloss black finish, the complete kit includes matching mounting hardware.

Fits '17-later Touring and Trike models.

25700631 Chrome. **\$159.95**

25700654 Gloss Black. **\$159.95**



A. INNER PRIMARY COVER TRIM – CHROME

B. INNER PRIMARY COVER – CHROME

Chrome is king. Visually widen the look of the primary cover without adding width or bulk. This chrome-plated Inner Primary completes the look of the powertrain and adds a custom touch that sets your bike apart from the others. Manufactured from Original Equipment components for exacting fit, the visual surfaces of this cover have been polished and plated to the highest Harley-Davidson standards. Installation requires separate purchase of model-specific Primary Cover Gaskets.

36500131 **\$349.95**

Fits '17-later Touring and Trike models.



A. INNER PRIMARY COVER TRIM – GLOSS BLACK

C. CYLINDER BASE COVER – CHROME

Add a finished chrome look to the left side of your Milwaukee-Eight® engine. Shaped to cover the connection of the engine to the primary cover, this trim piece is formed to seamlessly fill the area from the top of the primary to the bottom of the cylinder fins. This easy-to-install kit includes all necessary mounting hardware.

25700632 **\$74.95**

Fits '17-later Touring and Trike models.

D. STARTER MOTOR END COVER

It's the details that make the complete custom bike. This starter end cover dresses the end of the starter motor for a clean look. Available in mirror chrome or rich gloss black to match your customizing style.

Fits '17-later Touring and Trike models. Does not fit models equipped with CoolFlow™ Fan P/N 26800120, 26800121 or 26800128.

31400088 Chrome. **\$79.95**

31400090 Gloss Black. **\$79.95**



B. INNER PRIMARY COVER – CHROME



C. CYLINDER BASE COVER – CHROME



D. STARTER MOTOR END COVER – CHROME



D. STARTER MOTOR END COVER – GLOSS BLACK

Notice: The prices appearing in this catalog are the manufacturer's suggested retail prices. Actual retail prices may vary.



NEW

**E. PUSHROD COVER KIT – GLOSS BLACK
(SHOWN WITH TAPPET COVERS – GLOSS BLACK)**



NEW

E. PUSHROD COVER KIT – GLOSS BLACK



NEW

F. TAPPET COVERS – GLOSS BLACK



G. FRONT ENGINE MOUNT STABILIZER LINK



ENGINE TRIM 549

Engine Covers – Milwaukee-Eight®

E. PUSHROD COVER KIT – GLOSS BLACK

Complete the sinister look. These covers replace existing chrome covers to give your bike a blacked-out appearance down to the smallest detail. Pushrod covers are finished in gloss black and the kit includes the four bottom cover tubes, four upper clips and four center collars. Cover Kit can be installed on engines already equipped with Adjustable Pushrods or can be installed by removing rocker box covers, rocker arms and non-adjustable pushrods. Consult your dealer or service manual for installation.

17900081 **\$99.95**

Fits '17-later Milwaukee-Eight® engine-equipped models. Requires prior installation of Adjustable Pushrods or removal of rocker box covers, rocker arms and fixed-length pushrods.

F. TAPPET COVERS – GLOSS BLACK

Complete your Twin Cam engine's conversion to a total blacked-out look. These gloss black tappet blocks replace the stock bright-finished components for a sinister appearance, and are manufactured from Original Equipment components for perfect fit and function. Gasket surface has been masked to insure good oil seal. Kit comes complete with a front and rear cylinder lifter covers and two base gaskets.

25700890 **\$79.95**

Fit's '17-later Milwaukee-Eight engine-equipped models. Sold in pairs.

G. FRONT ENGINE MOUNT STABILIZER LINK

Add a custom style to the front end with this brilliant chrome-plated Engine Mount Stabilizer Link. This custom heim joint assembly complements the chrome Billet Front Engine Mount Bracket P/N 16205-10. Kit includes chrome mounting hardware.

Fits '09-later Touring and Trike models.

16213-10 Chrome. **\$54.95**

16400055 Black. **\$39.95**

H. FINNED SPARK PLUG COVERS

Complete the finned look from the base of the cylinder all the way to the rocker box. These aluminum Finned Spark Plug Covers fill the spark plug pockets and complete the horizontal fin look across the top of the left-hand side of the engine. Firmly held in place by spring clips, these easy to install finned covers slip into position and do not require removal of the spark plugs for installation. Sold in pairs.

Fits '17-later Milwaukee-Eight engines.

25800061 Black. **\$59.95**

25800062 Black Granite. **\$59.95**



H. FINNED SPARK PLUG COVERS



Model Family Fitment:

- V-ROD
- SPORTSTER
- DYNA
- SOFTAIL
- TOURING

Notice: The prices appearing in this catalog are the manufacturer's suggested retail prices. Actual retail prices may vary.

550 ENGINE TRIM

Engine Covers – Twin Cam

A. TWIN CAM ENGINE COVERS – GLOSS BLACK

These engine covers are the perfect start in converting your powertrain to an elegant tuxedo black look. Manufactured from Original Equipment components to ensure a perfect fit, these covers are masked and coated with temperature-resistant paint to ensure a long-lasting finish. Complete the look with matching primary covers, rocker housings, rocker covers, cam covers and transmission covers (sold separately).

25700021A Primary Cover. **\$269.95**
Fits '06-'17 Dyna® models with mid-controls.

60876-11A Primary Cover. **\$269.95**
Fits '07-'17 Softail® models. Also fits '06-'17 FLD and Dyna models equipped with factory forward controls. Will not fit with Accessory Forward Controls.

60886-11A Primary Cover. **\$269.95**
Fits '07-'15 Touring and Trike models (except FLHTCUL and FLHTKL).

25700438 Narrow Primary Cover. **\$269.95**
Fits '07-'16 Touring and Trike models. Installation requires separate purchase of narrow derby cover, derby cover gasket and primary gasket. Chrome is Original Equipment on '15-'16 FLHTCUL and FLHTKL and '16 Touring and Trike models.

17707-11 Rocker Box Cover. **\$74.95**
Fits '99-'16 Dyna, '00-'17 Softail, and '99-'16 Touring and Trike models (2 required).

17709-11 Rocker Box Lower Housing. **\$74.95**
Fits '99-'17 Dyna, '00-'17 Softail, and '99-'16 Touring and Trike models (2 required).

37198-11 Cam Cover. **\$139.95**
Fits '01-'17 Dyna, Softail and '01-'16 Touring and Trike models (except '01 EFI Touring).

37193-11 Transmission Side Cover. **\$74.95**
Fits '06-'17 Dyna, and '07-'17 Softail (except FLSS, FLSTFB, FXCW, FXCWC, FXSB and FXSE), and '07-'16 Touring and Trike models. Does not fit models equipped with a hydraulic clutch.

25700180 Transmission Side Cover. **\$89.95**
Fits '13-'16 Touring and Trike models equipped with hydraulic clutch.

37195-11 Transmission Top Cover. **\$74.95**
Fits '06-'17 Dyna and '07-later Softail and '07-'16 Touring and Trike models.

25700020 Derby Cover. **\$39.95**
Fits '06-'17 Dyna and '07-'18 Softail (except FLSS) and '07-'15 Touring and Trike models (except FLHTCUL, FLHTKL or '07-'15 Touring or Trike models equipped with Narrow-Profile Outer Primary Cover P/N 25700385 or 25700438).

25700477 Derby Cover. **\$44.95**
Fits '16-later Touring and Trike, and '15-later FLHTCUL and FLHTKL models. Also fits '07-later Touring and Trike models equipped with Narrow-Profile Outer Primary Cover P/N 25700385 or 25700438.

25600074 Timer Cover. **\$25.95**
Fits '99-'17 Twin Cam-equipped models.

NOTE: Removing and installing engine covers may require purchase of new gaskets. See dealer for information.



A. TWIN CAM ENGINE COVERS – GLOSS BLACK



A. TWIN CAM ENGINE COVERS – GLOSS BLACK

Notice: The prices appearing in this catalog are the manufacturer's suggested retail prices. Actual retail prices may vary.

ENGINE TRIM 551

Engine Covers – Twin Cam



B. TWIN CAM ENGINE COVERS – CHROME

B. TWIN CAM ENGINE COVERS – CHROME

Dress the engine of your Twin Cam-equipped model in chrome. These chrome-plated components are manufactured to Original Equipment specifications for exact fit and finish.

Outer Primary Covers

60764-06A **\$349.95**
Fits '06-'17 Dyna® models with mid-controls.

60782-06A **\$349.95**
Fits '06-'17 Dyna models with forward controls and '07-'17 Softail® models.

60553-07A **\$349.95**
Fits '07-'15 Touring and Trike models (except FLHTKL and FLHTCUL).

25700385 Narrow-Profile. **\$349.95**
Fits '07-'16 Touring and Trike models. Installation requires separate purchase of narrow derby cover, derby cover gasket and primary gasket. Chrome is Original Equipment on '15-'16 FLHTCUL and FLHTKL and '16 Touring and Trike models.

60543-99B **\$359.95**
Fits '99-'05 Dyna and '99-'06 Softail models.

60665-99B **\$359.95**
Fits '99-'06 Touring models. Fits '94-'98 Touring models when used with Clutch Cover P/N 60668-99 and Gasket P/N 25416-99C.

Cam Covers

25369-01B **\$174.95**
Fits '01-'17 Dyna, Softail, and '01-'16 Touring and Trike models. (except '01 EFI Touring).

25247-99 **\$174.95**
Fits '99-'00 Dyna '00 Softail, '99-'00 Touring and '01 EFI Touring models.

Transmission Side Covers

37116-06 **\$134.95**
Fits '06-'17 Dyna, and '07-'17 Softail (except FLSS, FLSTFBS, FXCW, FXCWC, FXSB and FXSE), and '07-'16 Touring and Trike models. Does not fit models equipped with a hydraulic clutch.

37105-99 **\$229.95**
Fits '99-'05 Dyna, '00-'06 Softail and '99-'06 Touring models.

Transmission Top Covers

34469-06B **\$174.95**
Fits '06-'17 Dyna, '07-'17 Softail and '07-'16 Touring and Trike models.

34469-01 Fits '01-'05 Dyna models. **\$174.95**

34469-99B Fits '99-'00 Dyna models. **\$239.95**

34541-00 **\$239.95**
Fits '00-'06 Softail and '01-'06 Touring models.

Rocker and Tappet Covers

Fits '99-'17 Dyna, '00-'17 Softail and '99-'16 Touring and Trike models.

17572-99 Rocker Cover. **\$114.95**

17573-99A Lower Rocker Housing. **\$114.95**

17964-99 Tappet Cover, Front. **\$39.95**

17966-99 Tappet Cover, Rear. **\$39.95**



B. TWIN CAM ENGINE COVERS – CHROME

Model Family Fitment:

- V-ROD
- SPORTSTER
- DYNA
- SOFTAIL
- TOURING

Notice: The prices appearing in this catalog are the manufacturer's suggested retail prices. Actual retail prices may vary.

552 ENGINE TRIM

Engine Covers – Twin Cam

A. BURST COLLECTION ENGINE COVERS

The Twin Cam engine is the focal point of your motorcycle, so dress it with pride. Burst Collection Engine Covers set the stage for a complete custom look. We start with beautifully polished cast or billet parts that are engineered to fit the bike perfectly. Then we apply a rich tuxedo black anodized finish and meticulously machine away the surface to expose the satin aluminum below. Start with a couple of components, or go all the way. The components replace the Original Equipment covers for superior fit. Complete the look with gloss black primary and transmission top covers (sold separately). Kits include chrome hardware.

25700249 Cam Cover. **\$219.95**
Fits '01-'17 Dyna®, Softail® and '01-'16 Touring and Trike models (except '01 EFI Touring).

25700251 Rocker Box Covers. **\$279.95**
Fits '99-'16 Touring and Trike models. Sold in pairs.

34800012 Transmission Side Cover. **\$219.95**
Fits '08-'09 FXDF, '10-'17 Dyna (except FXDLS), and '07-'17 Softail (except FLSS, FLSTFBS, FXCW, FXCWC, FXSB and FXSE) and '07-'16 Touring models. Does not fit models equipped with a hydraulic clutch.

34800026 Transmission Side Cover. **\$199.95**
Fits '16-'17 FXDLS and FXSE and '13-'16 Touring and Trike models equipped with hydraulic clutch.

25700250 Derby Cover. **\$159.95**
Fits '99-'00 Evolution® 1340, '99-'17 Dyna, '99-'18 Softail (except FLSS) and '99-'15 Touring and Trike models (except FLHTCUL, FLHTKL or '07-'15 Touring or Trike models with Narrow-Profile Outer Primary Cover P/N 25700385 or 25700438).

25700446 Derby Cover. **\$159.95**
Fits '16-later Touring and Trike, and '15-later FLHTCUL and FLHTKL models. Also fits '07-later Touring and Trike models equipped with Narrow-Profile Outer Primary Cover P/N 25700385 or 25700438.

NOTE: Removing and installing engine covers may require purchase of new gaskets. See dealer for information.

Shown with:

SCREAMIN' EAGLE® PERFORMANCE AIR CLEANER KIT – BURST COLLECTION*

Performance and style combined. Designed to complement the Burst Collection, this radical low profile air cleaner features a tuxedo black surround that has been expertly machined to expose the satin aluminum finish below. The billet cover conceals a one-piece cast back plate with integral breather and mounting bracket that promotes smooth air flow into the throttle body. The exposed reverse cone cotton element provides high-volumes of air and the element is washable for maximum efficiency and protection. The complete kit includes Burst Collection trim, backing plate, air cleaner element and all required installation hardware. 50-State U.S. EPA Compliant.

29000066 **\$374.95**
Fits '16-'17 Softail and '08-'16 Touring and Trike models with Original Equipment 50mm throttle body. Also fits '16-'17 FXDLS and Softail, '14-'17 CVO™ Softail and '14-'16 Touring models equipped with Screamin' Eagle® 58mm Throttle Body. All EFI models require ECM calibration for proper installation. '17-later models require recalibration with Screamin' Eagle Pro Street Tuner (sold separately).

29400178 **\$374.95**
Fits '08-'17 Dyna (except FXDLS), and '08-'15 Softail models (except '14-'15 FLSTNSE, '11-'12 FLSTSE and '13-'14 FXSBSE). All EFI models require ECM calibration for proper installation. '17-later models require recalibration with Screamin' Eagle Pro Street Tuner (sold separately).



GO LIGHT These Screamin' Eagle products are 50-state street compliant for sale and use on all vehicles, including those that are pollution-controlled. Complies with the requirements of 40 CFR Part 86, subparts E and F. Street legal and/or street compliant statements refer to product meeting 50-State emissions and noise standards in the United States.

Notice: The prices appearing in this catalog are the manufacturer's suggested retail prices. Actual retail prices may vary.



A. BURST COLLECTION ENGINE COVERS



A. BURST COLLECTION ENGINE COVERS

ENGINE TRIM 553

Engine Covers – Twin Cam



B. TWIN CAM ENGINE COVERS – WRINKLE BLACK

B. TWIN CAM ENGINE COVERS – WRINKLE BLACK

These black powder-coated engine covers are the perfect start in converting your powertrain to a striking wrinkle black look. Manufactured from Original Equipment components, these covers are masked and painted on the factory production paint line to ensure a matching wrinkle black or texture black finish and a perfect fit. Complete the blacked-out look with matching primary covers, rocker housings, rocker covers, cam covers and transmission covers (sold separately).

60758-06A Primary Cover. **\$269.95**
Fits '06-'17 Dyna® models with mid-controls.

60717-07A Primary Cover. **\$269.95**
Fits '07-'17 Softail® models. Also fits '06-'17 FLD and Dyna models equipped with factory forward controls.

60706-09A Primary Cover. **\$269.95**
Fits '07-'15 Touring and Trike models (except FLHTCUL or FLHTKL).

60715-99B Primary Cover. **\$269.95**
Fits '99-'05 Dyna and '99-'06 Softail models.

17620-99 Rocker Box Cover. **\$74.95**
Fits '99-'17 Dyna, '00-'17 Softail and '99-'16 Touring and Trike models (2 required).

17618-99A Rocker Box Lower Housing. **\$74.95**
Fits '99-'17 Dyna, '00-'17 Softail and '99-'16 Touring and Trike models (2 required).

25364-01B Cam Cover. **\$139.95**
Fits '01-'17 Dyna, Softail and '01-'16 Touring and Trike models (except '01 EFI Touring).

37135-06 Transmission Side Cover. **\$74.95**
Fits '06-'17 Dyna, '07-'17 Softail (except FLSS, FLSTFB, FXCW, FXCWC, FXSB and FXSE), and '07-'16 Touring and Trike models. Does not fit models equipped with a hydraulic clutch.

37189-99 Transmission Side Cover. **\$129.95**
Fits '99-'05 Dyna, '00-'06 Softail and '99-'06 Touring models.

34521-06B Transmission Top Cover. **\$74.95**
Fits '06-'17 Dyna and '07-'17 Softail, '07-'16 Touring and Trike models.

60713-07 Derby Cover. **\$44.95**
Fits '06-'17 Dyna and '07-'18 Softail (except FLSB), and '07-'15 Touring and Trike models (except FLHTCUL, FLHTKL or '07-'15 Touring or Trike models equipped with Narrow-Profile Outer Primary Cover P/N 25700385 or 25700438).

60713-99 Derby Cover. **\$44.95**
Fits '99-'05 Dyna and '99-'06 Softail and Touring models.

NOTE: Removing and installing engine covers may require purchase of new gaskets. See dealer for information.



B. TWIN CAM ENGINE COVERS – WRINKLE BLACK

Model Family Fitment:

- V-ROD
- SPORTSTER
- DYNA
- SOFTAIL
- TOURING

Notice: The prices appearing in this catalog are the manufacturer's suggested retail prices. Actual retail prices may vary.

554 ENGINE TRIM

Engine Covers – Twin Cam

A. INNER PRIMARY COVER – CHROME

Because all components in this cover are exactly like the Original Equipment part, you can be sure this cover will match your outer cover, right down to the high-quality chrome-plating. It completes the look of your powertrain without the hassle of troublesome exchange programs. This cover includes all bearings, dowel pins and seals already installed, to ensure Harley-Davidson quality. Requires separate purchase of model-specific Primary Cover Gasket and O-Ring.

60815-08A **\$329.95**

Fits '08-'17 FXCW, FXCWC, FXSB, FXSBSE, FXSE and '09 FXSTSE models.

60739-07 **\$399.95**

Fits '07-'16 Touring and Trike models.



A. INNER PRIMARY COVER – CHROME
(TOURING SHOWN)

B. EVOLUTION® 1340 ENGINE COVERS – CHROME

Inspection Covers – with Shifter Hole

60529-90A **\$89.95**

Fits '91-'05 Dyna® models (except FXDWG).

Inspection Covers – without Shifter Hole

60572-86 **\$49.95**

Fits '93-'05 FXDWG and '86-'06 FLST, FXST and FXSTS models.

60670-85A Fits '85-'06 FLT models. **\$54.95**

Outer Rocker Cover

Sold as separate pieces. Order two per vehicle.

17528-92 **\$99.95**

Fits '92-'99 Evolution® 1340-equipped models.

Rocker Cover Spacer

Sold as separate pieces. Order two per vehicle.

17529-92 **\$79.95**

Fits '92-'99 Evolution 1340-equipped models.

Lower Rocker Cover

Sold as separate pieces. Order two per vehicle.

17530-92 **\$139.95**

Fits '92-'99 Evolution 1340-equipped models.



A. INNER PRIMARY COVER – CHROME

Model Family Fitment:

- V-ROD
- SPORTSTER
- DYNA
- SOFTAIL
- TOURING

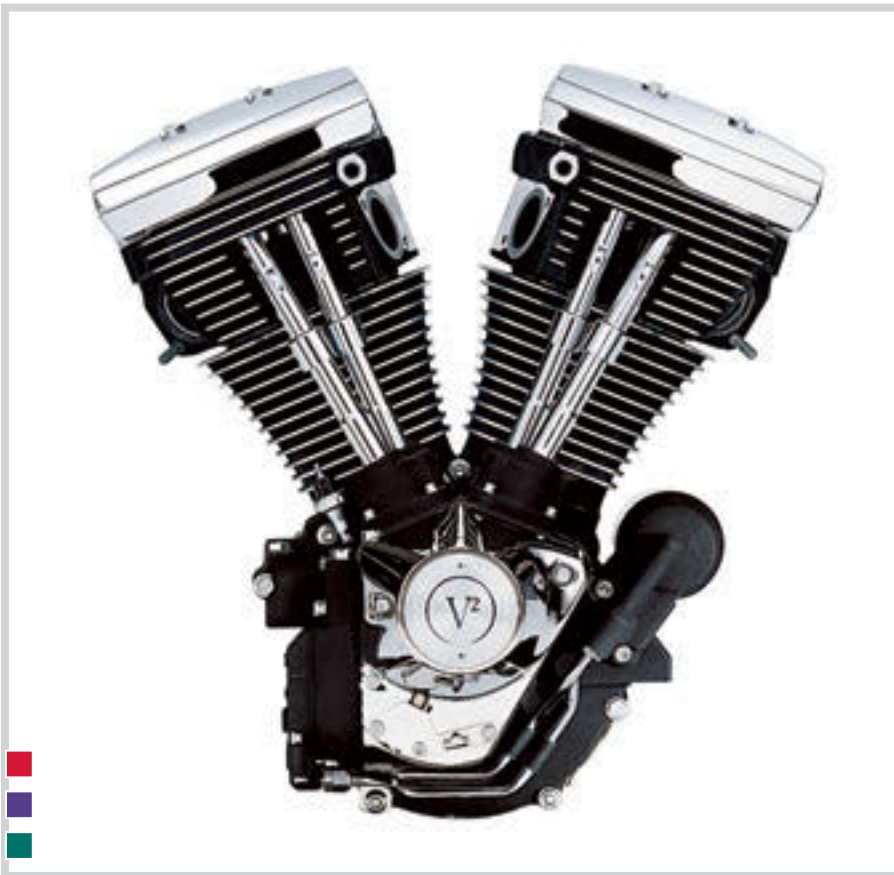

B. EVOLUTION 1340 ENGINE COVERS – CHROME

Notice: The prices appearing in this catalog are the manufacturer's suggested retail prices. Actual retail prices may vary.

ENGINE TRIM 555

Engine Covers – Twin Cam



**C. INNER PRIMARY COVER TRIM – CHROME
(TOURING AND TRIKE SHOWN)**

C. INNER PRIMARY COVER TRIM – CHROME

Get the look of a chrome inner primary cover without tearing apart the drive train. Designed to wrap the top surface of the painted inner primary cover, this mirror chrome die-cast shell provides a beefy finished look to the engine cases. Easy to install, the cover is secured with the outer primary hardware, and held in place at four points for quiet operation. Kit includes required mounting hardware. For a complete custom look, consider adding a Chrome Cylinder Base Cover and Classic Chrome Socket Head Screw Covers (sold separately).

60868-10 \$149.95

Fits '07-'17 Softail® models (except FLSTSC, FXCW, FXCWC, FXSB, FXSBSE and FXSE). Fits with Original Equipment shift linkage and Polished Shift Linkage P/N 33814-98A.

60885-10 \$149.95

Fits '09-'16 Touring and Trike models. Also fits with Chrome Starter Cover P/N 66477-10.



C. INNER PRIMARY COVER TRIM – CHROME



D. CYLINDER BASE COVER – SMOOTH

D. CYLINDER BASE COVER – SMOOTH

Add a finished chrome look to the left side of your Twin Cam engine. This easy-to-install kit includes all necessary mounting hardware.

32042-07 \$69.95

Fits '07-'17 Softail models (except FLSS and FLSTFBS). Will not fit CVO™ models and models equipped with 110 cubic inch engines.

32077-07 \$69.95

Fits '06-'17 Dyna® (except FXDLS) and '07-'16 Touring and Trike models. Will not fit CVO models and models equipped with 110 cubic inch engines.

E. TAPPET BLOCK ACCENT

Shaped to fill the gap between the tappet blocks, this unique cover adds a splash of chrome to the profile of your engine. The die-cast cover is polished and chrome-plated to a mirror finish. Easy to install.

61400002 \$79.95

Fits '99-'17 Twin Cam-equipped models. Does not fit with Lifter Block Covers P/N 18248-99, 18278-06 and 18262-00 or Billet Lifter Cover P/N 18088-02.



E. TAPPET BLOCK ACCENT



F. GASKET KIT FOR BLACK INNER PRIMARY

It's the details that count. This gasket kit eliminates the silver shadow line you see between the engine and primary. It's the perfect finishing touch any time the primary has been removed for engine service or during the installation of other accessories. Comprehensive kit contains all gaskets and hardware required to reinstall the primary.

25700337 \$61.95

Fits '06-'17 Dyna, '07-'17 Softail, and '07-'16 Touring and Trike models.



F. GASKET KIT FOR BLACK INNER PRIMARY



F. GASKET KIT FOR BLACK INNER PRIMARY

Notice: The prices appearing in this catalog are the manufacturer's suggested retail prices. Actual retail prices may vary.

556 ENGINE TRIM

Engine Covers – Twin Cam

A. ENGINE/TRANSMISSION INTERFACE COVER

Featuring a ribbed design for sharp surface contrasts, this chrome Engine/Transmission Interface Cover provides a custom option to conceal the space between the cam cover and the transmission. The cover stretches from the gearcase cover to the rear of the transmission, and frames the transmission side cover with a band of chrome for a complete custom look. Kit includes all necessary mounting hardware.

66543-08 **\$99.95**

Fits '07-'17 Softail® models (except FLSS, FLSTFBS, FLSTNSE, FLSTSC, FXCW, FXCWC, FXSB, FXSBSE and FXSE). Does not fit models equipped with hydraulic clutch.



A. ENGINE/TRANSMISSION INTERFACE COVER

B. STARTER COVER – CHROME

With the under-chassis exhaust crossover on the late model Touring bikes, the painted starter motor is now easily seen from both sides of the bike. This brilliantly chrome-plated cover conceals the starter motor and starter solenoid for a clean, custom look. Easy to install, this kit includes all required mounting hardware.

66477-10 **\$69.95**

Fits '09-'16 Touring and Trike models (except CVO™ and models with High Output Starter P/N 31621-06A or 31619-06A).



B. STARTER COVER – CHROME

C. HARLEY-DAVIDSON® GENUINE HIGH PERFORMANCE 1.4KW STARTER

This starter offers both great styling and increased performance, providing 15% greater torque than the stock replacement starter. Engineered and tested by Harley-Davidson from the ground up, this starter offers unparalleled reliability and durability. No special battery or battery cable requirements.

Fits '06-'17 Dyna® (except ABS equipped models) and '07-'17 Softail and '07-'16 Touring and Trike models.

31619-06A Black Finish. **\$429.95**

31621-06A Chrome Finish. **\$529.95**

Fits '99-'00 FXR, '94-'05 Dyna and '94-'06 Softail and Touring models.

31335-03A Black Finish. **\$429.95**

31559-99A Chrome Finish. **\$529.95**



C. HARLEY-DAVIDSON GENUINE HIGH PERFORMANCE 1.4KW STARTER – CHROME

C. HARLEY-DAVIDSON GENUINE HIGH PERFORMANCE 1.4KW STARTER – BLACK

D. STARTER SOLENOID COVER KIT – CHROME

Add chrome to an often overlooked area with this cover, featuring the same high-quality, bright finish used on most of our accessories.

31783-00 **\$21.95**

Fits '94-later models (except '02-'17 VRSC™, '15-later XG, '18-later Softail and '17-later Touring and Trike models).

E. OIL VENT LINE – CHROME

Add a final detail to your Touring model with this Chrome Oil Vent Line, constructed from steel tubing that's polished and chrome-plated for a brilliant finish. Kit includes polished and chrome-plated compression fittings, and installs easily for a custom look.

33111-02 **\$54.95**

Fits '02-'06 Touring models. Also fits '99-'06 Touring models equipped with Oil Filler Spout P/N 62470-02, 62453-02 or 62454-02A.



D. STARTER SOLENOID COVER KIT – CHROME

E. OIL VENT LINE – CHROME

Model Family Fitment:

- V-ROD
- SPORTSTER
- DYNA
- SOFTAIL
- TOURING

Notice: The prices appearing in this catalog are the manufacturer's suggested retail prices. Actual retail prices may vary.

ENGINE TRIM 557

Engine Covers – Twin Cam



F. BILLET FRONT ENGINE MOUNT BRACKET



F. FRONT ENGINE MOUNT COMPONENTS – CHROME

A must-have for any chrome connoisseur, this chrome-plated Front Engine Mount Bracket will set your custom apart from the rest. The chrome bracket is machined from premium 6061-T6 aluminum, and is a direct bolt-on replacement for the Original Equipment bracket. Can be used with the stock stabilizer link, or dressed up with the optional chrome Front Engine Mount Stabilizer Link P/N 16213-10. Kit includes chrome mounting hardware.

16205-10 Front Engine Mount Bracket. **\$129.95**
Fits '08-'16 Touring models.

Add a custom style to the front end with this brilliant chrome-plated Engine Mount Stabilizer Link. This custom heim joint assembly complements the chrome Billet Front Engine Mount Bracket P/N 16205-10. Kit includes chrome mounting hardware.

16213-10 Front Tie Link. **\$54.95**
Fits '09-later Touring and Trike models.

G. FRONT ENGINE MOUNT COMPONENTS – BLACK

Perfect for installation on a blacked-out engine, these black engine mount components replace the factory silver-finished parts and blend these functional items into the background. Manufactured from Original Equipment components for perfect fit and proven reliability.

16400056 Front Engine Mount Bracket. **\$39.95**
Fits '08-'16 Touring models.

16400055 Front Tie Link. **\$39.95**
Fits '09-later Touring models.



G. FRONT ENGINE MOUNT COMPONENTS – BLACK



H. PUSHROD COVER KIT – GLOSS BLACK

Complete the Dark Custom look. These covers replace existing chrome covers to give your bike a blacked-out appearance down to the smallest detail. Pushrod covers are finished in gloss black and the kit includes the four bottom cover tubes and the four upper clips. Installation retains the Original Equipment chrome short center tube to create a high-contrast accent. Cover Kit can be installed on engines already equipped with Adjustable Pushrods or can be installed by removing rocker box covers, rocker arms and non-adjustable pushrods. Consult your dealer or service manual for installation.

17900033 Covers Only. **\$69.95**
Fits '99-'17 Twin Cam-equipped models. Requires prior installation of Adjustable Pushrods or removal of rocker box covers, rocker arms and fixed-length pushrods.

I. PUSHROD TUBE COLLARS – GLOSS BLACK

Manufactured from Original Equipment components for perfect fit and function, these Pushrod Collars complete your Twin Cam engine's conversion to the total blacked-out look. Covers replace the chrome-finished factory covers, and fit with stock or Screamin' Eagle® Quick-Install Pushrods.

17900076 **\$29.95**
Fits '84-'00 Evolution® 1340 and '99-'17 Twin Cam-equipped models. Installation requires use of Adjustable Pushrods or removal of rocker box covers, rocker arms and fixed-length pushrods.

J. TAPPET COVERS – BLACK

Complete your Twin Cam engine's conversion to a total blacked-out look. These textured black tappet blocks replace the stock bright-finished components for a sinister appearance, and are manufactured from Original Equipment components for perfect fit and function.

25700653 **\$79.95**
Fits '99-'17 Twin Cam-equipped models. Sold in pairs.

K. STARTER MOTOR END COVER – GLOSS BLACK

It's the details that make the complete custom bike. This gloss black round starter end cover replaces the factory-installed chrome cover and is the ideal finishing touch for converting your powertrain to an elegant tuxedo black look. Manufactured from Original Equipment components to ensure a perfect fit, this cover is coated with temperature-resistant finish to ensure a long-lasting finish.

31400092 **\$24.95**
Fits '08-'16 Touring and Trike models.



H. PUSHROD COVER KIT – GLOSS BLACK



I. PUSHROD TUBE COLLARS – GLOSS BLACK



J. TAPPET COVERS – BLACK



K. STARTER MOTOR END COVER – GLOSS BLACK (SHOWN WITH SPEED CHECK TRANSMISSION DIPSTICK)

Notice: The prices appearing in this catalog are the manufacturer's suggested retail prices. Actual retail prices may vary.

558 ENGINE TRIM

Sportster® Engine & Transmission Trim

A. RAIL COLLECTION ENGINE COVERS

Tough broad shouldered attitude with an edge – that's what you get when you finish your ride with the Rail Collection. We start with factory engineered components to ensure perfect fit and function. Then we apply a rich durable gloss black finish to draw attention to the heart of the bike, and then add machined longitudinal strakes to provide visual length to the powertrain. The resulting look is masculine and aggressive – and it mixes well with either café or urban assault styles. Start with a couple of components, or go all the way.

1. Gearcase Cover

25700533 **\$279.95**
Fits '04-later XL models.

2. Transmission Sprocket Cover

34800032 **\$169.95**
Fits '04-later XL models. Does not fit models equipped with Rear Set Foot Controls P/N 50700040.

3. Rocker Box Lower Housing

25700600 **\$159.95**
Fits '04-later XL models. Sold in pairs.

4. Rocker Box Covers – Upper

25700531 **\$279.95**
Fits '04-later XL models. Sold in pairs.

5. Primary Cover

25700532 **\$259.95**
Fits '06-later XL models. Includes gloss black Chain Inspection Cover.

6. Timer Cover

25600060 **\$69.95**
Fits '04-later XL models. Includes chrome mounting hardware.

7. Derby Cover

25700541 **\$149.95**
Fits '04-later XL models. Includes chrome mounting hardware.

NOTE: Removing and installing engine covers may require purchase of new gaskets. See dealer for information.

Shown with:

SCREAMIN' EAGLE® PERFORMANCE AIR CLEANER KIT – RAIL COLLECTION

The look is bold and the performance exhilarating. This race-inspired air cleaner is engineered to flow through the perimeter and the face of the air filter, providing high volumes of unrestricted airflow to the engine. The open-design face plate features a rich black finish with machined longitudinal strakes to expose the glowing aluminum below. Kit includes air cleaner trim, one-piece cast back plate, high-flow washable air filter element, rain sock and all required hardware. 50-State U.S. EPA compliant.

29400232A **\$299.95**

Fits '07-later XL models with Original Equipment throttle body. All models require ECM Calibration for proper installation. '17-later models require recalibration with Screamin' Eagle® Pro Street Tuner (sold separately).



A. RAIL COLLECTION ENGINE COVERS



A. RAIL COLLECTION ENGINE COVERS



GO LIGHT These Screamin' Eagle products are 50-state street compliant for sale and use on all vehicles, including those that are pollution-controlled. Complies with the requirements of 40 CFR Part 86, subparts E and F. Street legal and/or street compliant statements refer to product meeting 50-State emissions and noise standards in the United States.

Notice: The prices appearing in this catalog are the manufacturer's suggested retail prices. Actual retail prices may vary.

ENGINE TRIM 559

Sportster® Engine & Transmission Trim

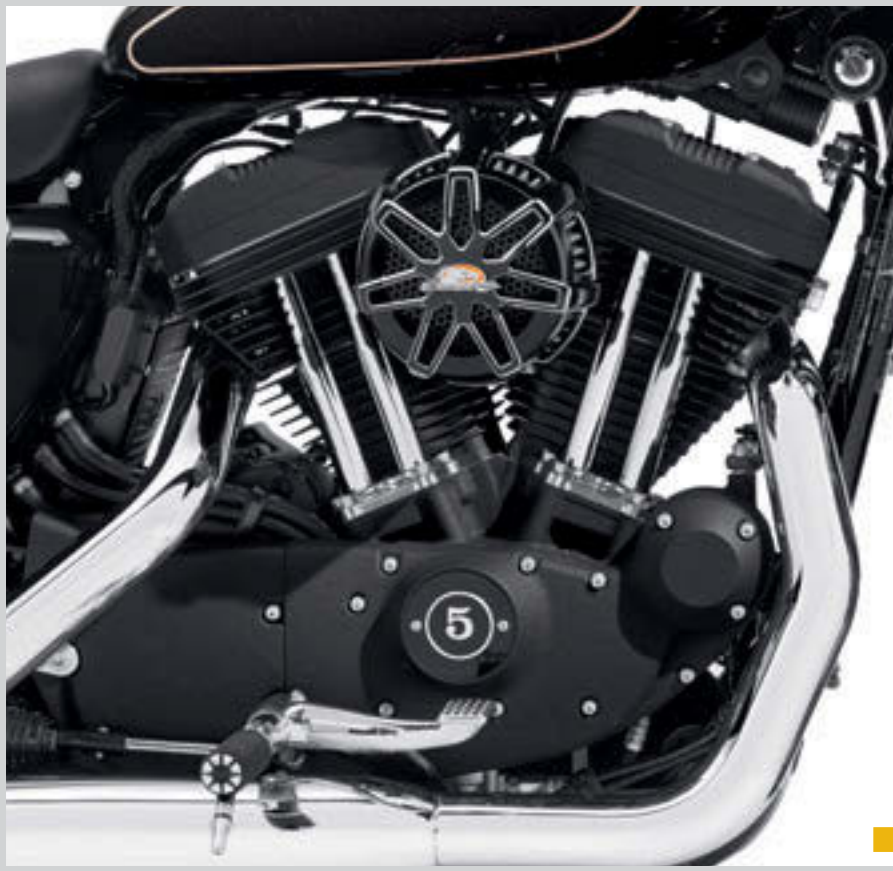

B. WRINKLE BLACK ENGINE COVERS

B. WRINKLE BLACK ENGINE COVERS

These black powder-coated engine covers are the perfect start in converting your powertrain to a striking wrinkle black look. Manufactured from Original Equipment components, these covers are masked and painted on the factory production paint line to ensure a matching wrinkle black or texture black finish and a perfect fit. Complete the blacked-out look with matching primary covers, rocker housings, rocker covers, cam covers and transmission covers (sold separately).

1. Gearcase Cover

25486-05 Fits '04-later XL models. **\$369.95**

2. Transmission Sprocket Cover

34943-05 Fits '04-later XL models. **\$81.95**

3. Rocker Box Lower Housing (each)

17645-07A Fits '07-later XL models. **\$99.95**

4. Rocker Box Cover (each)

17655-05 Fits '04-later XL models. **\$74.95**

5. Primary Cover

25307-06 Fits '06-later XL models. **\$269.95**

6. Primary Chain Inspection Cover

34794-05A Fits '04-later XL models. **\$19.95**

7. Derby Cover

34790-05 Fits '04-later XL models. **\$39.95**

NOTE: Removing and installing engine covers may require purchase of new gaskets. See dealer for information.

Shown with:

SCREAMIN' EAGLE® EXTREME BILLET AIR CLEANER KIT – CHISEL

The bold styling of this intake system looks just as impressive as the long patch of burnout rubber you just laid down. The forged billet aluminum cover tops off a cast back plate with integral breather for a smooth transition to the throttle body. The race-inspired air cleaner is engineered to flow high volumes of air and the washable pleated element provides the ideal combination of efficiency and engine protection. Available in your choice of style and finish, this easy-to-install kit includes all mounting hardware and rain sock. 50-State U.S. EPA compliant.

29400127 Cut Back Gloss Black. **\$349.95**

Fits '07-later XL models with Original Equipment throttle body. All EFI models require ECM calibration for proper installation. '17-later models require recalibration with Screamin' Eagle® Pro Street Tuner (sold separately). Labor cost not included. See Dealer for details.



B. WRINKLE BLACK ENGINE COVERS



GO LIGHT These Screamin' Eagle products are 50-state street compliant for sale and use on all vehicles, including those that are pollution-controlled. Complies with the requirements of 40 CFR Part 86, subparts E and F. Street legal and/or street compliant statements refer to product meeting 50-State emissions and noise standards in the United States.

Model Family Fitment:

- V-ROD
- SPORTSTER
- DYNA
- SOFTAIL
- TOURING

Notice: The prices appearing in this catalog are the manufacturer's suggested retail prices. Actual retail prices may vary.

560 ENGINE TRIM

Sportster® Engine & Transmission Trim

A. CHROME ENGINE COVERS

Dress the engine of your Sportster® model in chrome. These polished and chrome-plated components are manufactured to Original Equipment specifications for exact fit and finish.

1. Primary Cover

25460-06 Fits '06-later XL models. **\$349.95**

25460-04 Fits '04-'05 XL models. **\$349.95**

25460-94 Fits '94-'03 XL models. **\$374.95**

2. Gearcase Cover

25213-04 Fits '04-later XL models. **\$439.95**

3. Transmission Sprocket Cover

34932-04 Fits '04-later XL models. **\$129.95**

4. Rocker Box Lower Housing (each)

17537-07A Fits '07-later XL models. **\$114.95**

17537-96C Fits '86-'06 XL models. **\$114.95**

5. Rocker Box Cover (each)

17551-04 Fits '04-later XL models. **\$98.95**

6. Primary Chain Inspection Cover

34761-04A Fits '04-later XL models. **\$24.95**

7. Derby Cover

34760-04 Fits '04-later XL models. **\$69.95**

Also available:

CHROME ENGINE KIT – SPORTSTER®

Upgrade your motor with brilliant chrome components. Kit includes chrome gear cover, transmission sprocket cover, primary chain inspection cover, derby cover, inner and outer rocker covers and all gaskets.

16295-07A **\$949.95**

Fits '07-later XL models. Stock on '07-later XL1200C, XL1200L, XL1200T, XL1200V and XL 50th Anniversary models.

Shown with:

SMOOTH AIR CLEANER COVER

Wrap your Screamin' Eagle® round air cleaner element in style. The mirror chrome low-profile Air Cleaner Cover shields the element and opens breathing space between the backing plate and the cover. Cut-away bottom design exposes the air cleaner element to maximize the airflow. Easy to install, the one-piece cover is the ideal complement to the Chrome Air Cleaner Back Plate P/N 29510-05.

29153-07 **\$49.95**

Fits '07-later XL models equipped with Screamin' Eagle Round High-Flow Air Cleaner Kits and '99-'17 Twin Cam models equipped with Screamin' Eagle Round High-Flow Air Cleaner Kits.



A. CHROME ENGINE COVERS



A. CHROME ENGINE COVERS

Notice: The prices appearing in this catalog are the manufacturer's suggested retail prices. Actual retail prices may vary.

ENGINE TRIM 561

Sportster® Engine Trim



NEW

B. PUSHROD COVER KIT – GLOSS BLACK



NEW

C. TAPPET COVERS – GLOSS BLACK

B. PUSHROD COVER KIT – GLOSS BLACK

These Pushrod Covers add to your bike's blacked-out look and are coated with durable, heat-resistant gloss black paint. The kit includes four bottom cover tubes and four upper clips. Pushrod Covers are great add-on when upgrading the top-end of your engine with Screamin' Eagle® performance cylinder heads.

17900083 **\$59.95**

Fits '04-later XL and XR models. Includes 4 Pushrod covers. Requires removal of cylinder heads for installation.

C. TAPPET COVERS – GLOSS BLACK

Complete your Sportster® engine's conversion to a total blacked-out look. These Tappet Covers replace the bright-finished stock covers and are manufactured from Original Equipment components with heat resistant gloss black paint for perfect fit and function.

17900084 **\$79.95**

Fits '04-later XL and XR models. Includes 2 covers and 2 gaskets. Requires removal of cylinder heads for installation.

D. FRONT ENGINE MOUNT BRACKET

A must-have for any chrome connoisseur; this chrome-plated Front Engine Mount Bracket will set your custom apart from the rest. The chrome bracket is machined from premium 6061-T6 aluminum and is a direct bolt-on replacement for the Original Equipment upper bracket. Can be used with the stock stabilizer link or dressed up with the optional chrome Front Engine Mount Stabilizer Link P/N 16400020. Kit includes chrome mounting hardware.

16400022 **\$129.95**

Fits '04-later XL models.

E. FRONT ENGINE MOUNT STABILIZER LINK

Add a custom style to the front end with this brilliant chrome-plated Engine Mount Stabilizer Link. This custom heim joint assembly is designed to link the engine to the engine mount bracket and can be used to replace the Original Equipment upper or lower front tie link. For a complete transformation, install two Stabilizer Links and the complementing chrome Billet Front Engine Mount Bracket P/N 16400022. Kit includes one stabilizer link and chrome mounting hardware.

16400020 **\$49.95**

Fits '04-later XL and '08-'13 XR models.

F. AIR CLEANER COVER – GLOSS BLACK

Add a dark look without changing the function of your Original Equipment air cleaner.

29084-04DH **\$94.95**

Fits '04-later XL models with Oval Air Cleaner.

G. REAR BRAKE RESERVOIR COVER – CHROME

Dress the remote brake fluid reservoir with a new chrome skin. Kit includes chrome top cover with Bar & Shield medallion, reservoir side cover, chrome hardware and a Torx® wrench for easy installation.

45424-08 **\$35.95**

Fits '07-'13 XL models.



D. FRONT ENGINE MOUNT BRACKET



E. FRONT ENGINE MOUNT STABILIZER LINK



F. AIR CLEANER COVER – GLOSS BLACK



G. REAR BRAKE RESERVOIR COVER – CHROME

Model Family Fitment:

■ V-ROD ■ SPORTSTER ■ DYNA
■ SOFTAIL ■ TOURING

Notice: The prices appearing in this catalog are the manufacturer's suggested retail prices. Actual retail prices may vary.

562 ENGINE TRIM

Air Cleaner Covers

A. DARK CUSTOM™ LOGO COLLECTION – AIR CLEANER TRIM

The famous Harley-Davidson #1 logo with a sinister twist. Styled to complement chrome or blacked-out motorcycles, this rich black air cleaner trim features a machined Dark Custom #1 logo at its center. Formed from aluminum, this self-adhesive buckshot-hole cover fits perfectly into the recessed face of the Original Equipment Softail® perimeter-bolt air cleaner cover.

61300892 **\$49.95**
Fits '18-later FLFB, FLSB, FXBB, FXBR and FXFB models with Original Equipment perimeter bolt air cleaner cover.

B. AIR CLEANER TRIM – BAR & SHIELD

Styled to complement polished or blacked-out engines, this rich black bullet-hole air cleaner trim features a simple etched Bar & Shield logo at its center. Easy to install, this self-adhesive formed aluminum trim fits perfectly into the recessed face of the Softail models Original Equipment perimeter bolt air cleaner cover.

61300891 **\$49.95**
Fits '18-later FLFB, FLSB, FXBB, FXBR and FXFB models with Original Equipment perimeter bolt air cleaner cover.

C. AIR CLEANER TRIM – BRUSHED ALUMINUM

Show off your Milwaukee-Eight® engine's displacement with pride. Available for 107 and 114 cubic inch engines, this brushed aluminum and black trim is the perfect complement to chrome or black engine finishes. This easy to install self-adhesive formed aluminum trim fits perfectly into the recessed face of the Softail models Original Equipment perimeter bolt air cleaner cover.

Fits '18-later FLFB, FLSB, FXBB, FXBR and FXFB models with Original Equipment perimeter bolt air cleaner cover.

61300788 107 Logo. **\$44.95**
61300787 114 Logo. **\$44.95**



A. DARK CUSTOM LOGO COLLECTION – AIR CLEANER TRIM



B. AIR CLEANER TRIM – BAR & SHIELD



C. AIR CLEANER TRIM – BRUSHED ALUMINUM

Notice: The prices appearing in this catalog are the manufacturer's suggested retail prices. Actual retail prices may vary.

ENGINE TRIM 563

Air Cleaner Covers



D. SCREAMIN' EAGLE VENTILATOR ELITE AIR CLEANER COVER – CHROME

D. SCREAMIN' EAGLE® VENTILATOR ELITE AIR CLEANER COVER

Add a luxurious finishing touch to your Ventilator Air Cleaner. Designed as a direct replacement for the Screamin' Eagle® and CVO™ Ventilator Air Cleaners, this easy to install cover features a sleek center bar design surrounded with carbon fiber inserts. Kit includes low-profile cover, diamond-cut Screamin' Eagle medallion and chrome mounting hardware.

Fits '10-'17 Dyna®, '09-'16 Softail®, '09-'16 Touring and Trike models equipped with Ventilator Air Cleaner Kits. Also fits Dyna HO103 and CVO™ models with Original Equipment Ventilator Air Cleaner.

61300516	Chrome.	\$109.95
61300517	Gloss Black.	\$109.95



D. SCREAMIN' EAGLE VENTILATOR ELITE AIR CLEANER COVER – GLOSS BLACK

E. MILWAUKEE-EIGHT® ENGINE AIR CLEANER COVER – GLOSS BLACK

Complete the blacked-out look. This Gloss Black Air Cleaner Cover adds a sinister touch without changing the signature profile of your Milwaukee-Eight® engine.

61300828 **\$69.95**

Fits '17-later Touring (except CVO) and Trike models with Original Equipment air cleaner or Screamin' Eagle Wedge High-Flow Air Cleaner.

F. AIR CLEANER COVER – GLOSS BLACK

Complete the blacked-out look. Original Equipment on the FLSS model, this Gloss Black Air Cleaner Cover adds a sinister touch without changing the signature profile of your late model Twin Cam motor.

61300536 **\$69.95**

Fits '16-'17 Softail (except FLSTFBS) and '14-'16 Touring and Trike models (except CVO) with Original Equipment Air Cleaner or models equipped with Screamin' Eagle Round High-Flow Air Cleaner P/N 29400233 or 29400234.



E. MILWAUKEE-EIGHT ENGINE AIR CLEANER COVER – GLOSS BLACK



F. AIR CLEANER COVER – GLOSS BLACK

Model Family Fitment:

V-ROD	SPORTSTER	DYNA
SOFTAIL	TOURING	

Notice: The prices appearing in this catalog are the manufacturer's suggested retail prices. Actual retail prices may vary.

564 ENGINE TRIM

Air Cleaner Covers

A. NOSTALGIC BAR & SHIELD LOGO AIR CLEANER COVER

Get a polished look with an extra dose of heritage with the Nostalgic Collection – chrome-plated air cleaner covers featuring an original-style Bar & Shield logo and a stamped “Made in U.S.A.” An easy-to-install trip down memory lane, each cover is hand-polished and chrome-plated to a brilliant finish. Available in oval and round configurations, the air cleaner kit includes polished stainless steel mounting hardware.

29765-01 Oval Twin Cam. **\$79.95**
Fits '04-'07 EFI Dyna®, '01-'16 Softail® (except carbureted California and '08-later FLS, FLSS, FLSTFBS, FLSTSB and FXS) and '02-'13 later Touring and Trike models (except carbureted California). If installed with Screamin' Eagle® High-Flow Air Cleaner Kits, requires the separate purchase of Gasket P/N 29591-99.

29138-91A Round. **\$79.95**
Fits '90-'99 carbureted (CV) Evolution® 1340-equipped models. Also fits '07-later XL and '99-'17 Twin Cam models equipped with Screamin' Eagle High-Flow Air Cleaners (round filter) when installed with Gasket Kit P/N 29591-99 (sold separately).



A. NOSTALGIC BAR & SHIELD LOGO AIR CLEANER COVER – OVAL TWIN CAM

B. SMOOTH AIR CLEANER COVER

Wrap your Screamin' Eagle round air cleaner element in style. The mirror chrome low-profile Air Cleaner Cover shields the element and opens breathing space between the backing plate and the cover. Cut-away bottom design exposes the air cleaner element to maximize the airflow. Easy to install, the one-piece cover is the ideal complement to the Chrome Air Cleaner Back Plate P/N 29510-05.

29153-07 **\$49.95**
Fits '07-later XL models equipped with Screamin' Eagle Round Filter Air Cleaner Kits and '99-'17 Twin Cam models equipped with Screamin' Eagle Round High-Flow Air Cleaner Kits.

C. BOBBER-STYLE ROUND AIR CLEANER COVER

Low-profile round air cleaner cover adds an attractive nostalgic look to any bike's profile. This cover can be accented with your choice of stylish air cleaner trim collections (sold separately) for a personalized look. The cover features a cut-away bottom design that exposes the filter element to maximize the airflow when installed with a Screamin' Eagle High-Flow Air Cleaner Kit.

Fits '12-'16 XL1200V and '11-'15 FLS and FXS models with Original Equipment round air cleaner. Also fits models equipped with Screamin' Eagle Round High-Flow Air Cleaner Kits.

61300120 Chrome. **\$54.95**
61300128 Gloss Black. **\$54.95**



A. NOSTALGIC BAR & SHIELD LOGO AIR CLEANER COVER – ROUND



B. SMOOTH AIR CLEANER COVER



C. BOBBER-STYLE ROUND AIR CLEANER COVER – CHROME



C. BOBBER-STYLE ROUND AIR CLEANER COVER – GLOSS BLACK

Model Family Fitment:

- V-ROD
- SPORTSTER
- DYNA
- SOFTAIL
- TOURING

Notice: The prices appearing in this catalog are the manufacturer's suggested retail prices. Actual retail prices may vary.

ENGINE TRIM 565

Oil Temp & Level



D. OIL LEVEL AND TEMPERATURE DIPSTICK – CHROME (DYNA SHOWN)

D. OIL LEVEL AND TEMPERATURE DIPSTICK – BLACK (DYNA SHOWN)



D. OIL LEVEL AND TEMPERATURE DIPSTICK – CHROME (SPORTSTER SHOWN)

D. OIL LEVEL AND TEMPERATURE DIPSTICK – BLACK (SOFTAIL SHOWN)



E. OIL DIPSTICK WITH TEMPERATURE GAUGE (SOFTAIL SHOWN)

E. OIL DIPSTICK WITH TEMPERATURE GAUGE ('04-LATER SPORTSTER SHOWN)

D. OIL LEVEL AND TEMPERATURE DIPSTICK WITH LIGHTED LCD READOUT

New and improved capacitive level sensing technology provides the highest degree of accuracy and durability. Now available in chrome and black, these dipsticks allow you to check your oil level and oil temperature with the push of a button. Add function and style by replacing your stock dipstick with this hard working version. No more grabbing a rag to pull your hot dipstick. No more oil drips on your pipes and on the garage floor. Simply push the button and this dipstick lights up with a brilliant backlight. Oil level is indicated by a four-segment readout – it even reminds you to check your oil when it is hot. Designed to be waterproof, the LCD (liquid crystal display) readout operates on a long-lasting, replaceable lithium coin-type battery (CR2032 3V, P/N 91800066). Display features a low battery indicator and press-and-hold feature to toggle between Fahrenheit and Celsius.

Fits '04-later XL and XR models.

62700009	Chrome.	\$149.95
62700011	Gloss Black.	\$149.95

Fits '06-'17 Dyna® models (except FLD).

62974-09A	Chrome.	\$149.95
63065-09A	Gloss Black.	\$149.95

Fits '00-'17 Softail® models (except FXCW, FXCWC, FXSB, FXSBSE, FXSE and '09 FXSTSSE).

62955-09A	Chrome.	\$149.95
63055-09A	Gloss Black.	\$149.95

Fits '08-'17 FXCW, FXCWC, FXSB, FXSBSE, FXSE and '09 FXSTSSE models.

63002-09A	Chrome.	\$149.95
------------------	---------	-----------------

Fits '17-later Touring models.

62700180	Chrome.	\$149.95
62700194	Gloss Black.	\$149.95

Fits '07-'16 Touring models (except models equipped with a Sidecar). Will not fit Touring models equipped with Engine/Transmission Interface Cover P/N 66532-07.

63004-09A	Chrome.	\$149.95
63030-09A	Gloss Black.	\$149.95

Fits '02-'06 Touring models (except models equipped with a Sidecar). Also fits '99-'01 Touring models equipped with Chrome Oil Filler Spout P/N 62470-02, 62453-02 or 62454-02A.

62946-09A	Chrome.	\$149.95
63131-09A	Gloss Black.	\$149.95

Fits '09-'16 Trike models. Also fits '09-'16 Touring models equipped with a sidecar.

62700005A	Chrome.	\$149.95
------------------	---------	-----------------

Also available:

LCD DIPSTICK BATTERY AND SEAL KIT

Kit includes CR2032 3V Lithium Replacement Battery and waterproof seal kit.

91800066	\$8.95
-----------------	---------------

E. OIL DIPSTICK WITH TEMPERATURE GAUGE

Replace your Original Equipment oil dipstick with this custom-styled version featuring an easy-to-see mechanical temperature readout with Harley-Davidson logo. A chrome-plated cap completes the styling and provides an easy grip for removal.

62896-00B	\$39.95
------------------	----------------

Fits '00-'17 Softail models (except FXCW, FXCWC, FXSB, FXSBSE, FXSE and '09 FXSTSSE).

62668-87TA	Fits '84-'99 Softail models.	\$39.95
-------------------	------------------------------	----------------

63023-05	Fits '04-later XL and XR models.	\$59.95
-----------------	----------------------------------	----------------

62667-87TA	Fits '82-'03 XL models.	\$39.95
-------------------	-------------------------	----------------

566 ENGINE TRIM

Oil Level Dipsticks & Fuel Lines

A. CHROME OIL DIPSTICK

Easy-to-install chrome-plated oil dipstick adds a finishing touch and shows your attention to detail.

62693-07A	Fits '07-later Touring models.	\$64.80
62858-99	Fits '99-'06 Touring models.	\$39.95
62692-07	Fits '06-'17 Dyna® models.	\$54.95

B. SPEED-CHECK TRANSMISSION DIPSTICK

This decorative and functional dipstick is hand-operated, eliminating the need for a wrench. It has a Bar & Shield logo and is easy to install.

37103-08	\$29.95
Fits '06-'17 Dyna (except models with ABS), '07-'17 Softail®, and '07-'16 Touring and Trike models. Will not fit Touring models equipped with Engine/Transmission Interface Cover P/N 66532-07.	

37123-98A	\$29.95
Fits '87-'99 Evolution® 1340-equipped models, '99-'05 Dyna, '00-'06 Softail and '99-'06 Touring. (Does not fit with Oil Pump Cover P/N 66394-93 and 66088-96, Interface Cover P/N 66508-00, or models equipped with hydraulic clutch.)	

C. SPEED CHECK TRANSMISSION DIPSTICK – GLOSS BLACK

This decorative and functional dipstick is hand-operated, eliminating the need for a wrench. Finished in an elegant gloss-black to complete the Dark Custom transition.

62700192	\$29.95
Fits '06-'17 Dyna (except models with ABS), '07-'17 Softail, and '07-'16 Touring and Trike models. Will not fit Touring models equipped with Engine/Transmission Interface Cover P/N 66532-07.	

D. FUEL TANK FITTING COVER

This classic chrome styled two piece die-cast cover conceals the EFI fuel line fitting below the tank. Easy to install, the kit includes chrome-plated hardware and hex key wrench.

62809-06	\$31.95
Fits '04-'07 fuel injected Dyna, '02-'17 fuel injected Softail and '03-'16 fuel injected Touring and Trike models.	

E. BRAIDED STAINLESS STEEL EFI FUEL LINE

Add a finishing touch to the fuel-injected Dyna with this Braided Stainless Steel Fuel Line. Complete replacement line includes pre-installed fuel tank and EFI module connectors.

63020-04	\$39.95
Fits '04-'05 EFI Dyna models.	

F. BRAIDED STAINLESS STEEL FUEL CROSSOVER LINE

A beautifully Braided Line accented with highly polished chrome fittings for your front fuel tank crossover. Innovative fittings are designed to eliminate unsightly hose clamps.

63698-02	Fits '97-'07 Touring models.	\$37.95
63692-00A	Fits '00-'17 Softail models (except FXCW, FXCWC and FXSTD).	\$37.95

G. ENRICHENER/CHOKE KNOB COVER

A subtle chrome touch that can make all the difference, this cover features the Bar & Shield logo and can be installed in minutes.

29431-97	Fits '86-'06 carbureted models.	\$29.95
-----------------	---------------------------------	----------------

H. CV CARBURETOR TOP COVER – BAR & SHIELD

Die-cast and chrome-plated cover with chrome-plated mounting hardware.

27040-88T	\$24.95
Fits '88-'06 XL, '90-'00 Evolution 1340 and '99-'06 Twin Cam-equipped models with CV carburetors. Works with Screamin' Eagle® 44mm CV Carburetor Kit P/N 27934-99. (Does not fit fuel injected models.)	



A. OIL DIPSTICK – '06-LATER DYNA



B. SPEED-CHECK TRANSMISSION DIPSTICK – (37103-08 SHOWN)



C. SPEED CHECK TRANSMISSION DIPSTICK



D. FUEL TANK FITTING COVER



E. BRAIDED STAINLESS STEEL EFI FUEL LINE



F. BRAIDED STAINLESS STEEL FUEL CROSSOVER LINE



G. ENRICHENER/CHOKE KNOB COVER



H. CV CARBURETOR TOP COVER – BAR & SHIELD

Notice: The prices appearing in this catalog are the manufacturer's suggested retail prices. Actual retail prices may vary.

ENGINE TRIM 567

Cylinder Head Covers



I. FINNED HEADBOLT BRIDGE – BLACK HIGHLIGHTED



I. FINNED HEADBOLT BRIDGE – CVO GRANITE HIGHLIGHTED



I. FINNED HEADBOLT BRIDGE – SOLID BLACK



J. HEADBOLT BRIDGE – CHROME



K. SPARK PLUG COVERS (32745-99 SHOWN)



L. HEADBOLT COVERS – BRASS COLLECTION

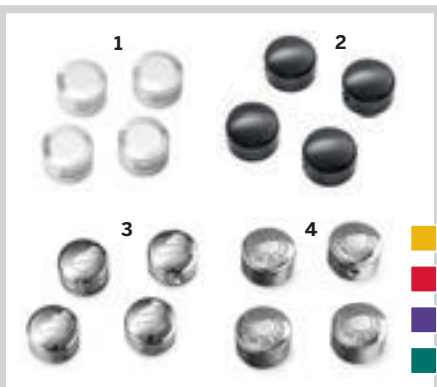

M. HEADBOLT COVERS



N. CLASSIC CHROME ROCKER BOX BOLT COVERS

I. FINNED HEADBOLT BRIDGE

This exclusive aluminum Finned Headbolt Bridge covers both headbolts and the spark plug, filling out your cylinder fins all the way to the rocker box. Featuring an engraved Bar & Shield emblem, the bridge is easy to install with unique headbolt mounts. All necessary mounting hardware included. Sold in pairs.

43859-00 Black Highlighted. **\$64.95**
Fits '99-'17 Twin Cam-equipped models with electronic fuel injection and '00-later FXSTD models.

61400148 CVO™ Granite Highlighted. **\$64.95**
Fits '99-'17 Twin Cam-equipped models with electronic fuel injection and '00-later FXSTD models.

61400176 Solid Black. **\$54.95**
Fits '04-later XL models.

J. HEADBOLT BRIDGE – CHROME

This exclusive Headbolt Bridge covers both the headbolts and spark plug with a splash of chrome and an engraved Bar & Shield emblem. Easy to install with unique headbolt mounts. Kit includes all necessary mounting hardware. Sold in pairs.

43858-00 **\$64.95**
Fits '99-'17 Twin Cam-equipped models. (Will not fit with Screamin' Eagle® heads or 110CI or 117CI engines.)
Sold in pairs.

44432-04 **\$64.95**
Fits '04-later XL and XR models.

K. SPARK PLUG COVER KITS

Quickly slips over spark plug for a secure fit.

32747-99 Classic Chrome. **\$24.95**
Fits '99-'17 Twin Cam-equipped models.

32745-99 H-D Motor Co. Logo. **\$24.95**
Fits '99-'17 Twin Cam-equipped models.

L. HEADBOLT COVERS – BRASS COLLECTION

Precision-machined of solid brass, these easy-to-install covers hide the Original Equipment head bolts for a clean custom touch. These heritage-inspired Headbolt Covers feature a natural antique finish that will age and patina when exposed to the elements. Kits include 4 covers, set screws and a wrench for easy installation.

61400335 **\$54.95**
Fits '86-later XL, '08-'13 XR, '85-'99 Evolution® 1340 and '99-'17 Twin Cam models.

M. HEADBOLT COVERS

Precision-machined of high-quality aluminum and manufactured in the U.S.A. Hand-polished and chrome-plated. Available in a variety of styles to match your customizing direction, these kits include 4 easy-to-install headbolt covers, set screws and an Allen® wrench for easy installation.

Fits '86-later XL, '08-'13 XR, '85-'99 Evolution 1340 and '99-'17 Twin Cam models.

1. 43822-01 Chrome. **\$43.95**

2. 43896-99 Gloss Black. **\$43.95**

3. 43911-95 Chrome Bar & Shield Logo. **\$39.95**

4. 43884-96 Chrome H-D Motor Co. Logo. **\$39.95**

N. CLASSIC CHROME ROCKER BOX BOLT COVERS

Matching the styling of our classic chrome headbolt covers, these chrome-plated Rocker Box Bolt Covers add chrome to your engine. Easy to install, the covers are held in place by a spring steel clip. Sold in packages of four.

43868-99 **\$26.95**
Fits '99-'17 Twin Cam-equipped models.

Model Family Fitment:

- V-ROD
- SPORTSTER
- DYNA
- SOFTAIL
- TOURING

Notice: The prices appearing in this catalog are the manufacturer's suggested retail prices. Actual retail prices may vary.

568 ENGINE TRIM

Hardware Covers

A. CLASSIC COVERS KIT

Customize your bike down to the last detail. These hardware Cover Kits include the chrome-plated ABS caps and plugs in the sizes and styles required to dress the viewable hardware on the motorcycle. Classic Covers are available as complete Bike Kits with the covers for both engine and chassis hardware, or as engine-only kits to dress the Twin Cam or XL engine. The kits are easy to install, with no tools required.

94923-09 Bike Kit. **\$269.95**
Fits '09-'17 Softail® models (except FLS, FLSS, FLSTSB, FXCW, FXCWC and FXSE).

94924-09 Bike Kit. **\$269.95**
Fits '09-'13 Touring and Trike models.

94943-07 Engine Kit. **\$149.95**
Fits Twin Cam-equipped models.



A. CLASSIC COVERS KIT

Typical Classic Covers Kit Contents

Intended Fastener	Part Number	Bike Kit	Bike Kit	Engine Kit
		'09-'17 Softail	'09-'16 Touring	Twin Cam models
		94923-09	94924-09	94943-07
1/4" socket head cap screw	94903-07	50	55	50
5/16" socket head cap screw	94904-07	11	8	7
5/16" socket head cap screw (plug)	94905-07	4	—	—
3/8" socket head cap screw	94906-07	6	3	3
5/16" special hex screw (angled cap)	94907-07	8	8	8
5/16" T40 Torx® button head screw	94908-07	5	10	—
3/8" T45 Torx button head screw	94909-07	5	—	—
1/4" 12-point screw	94910-07	—	—	—
10mm 12-point screw	94911-07	5	4	—
1/2" flanged hex bolt	94912-07	1	2	—
3/8" T45 Torx button head screw	94913-07	10	2	—
7/16" hex bolt	94914-07	5	—	—
3/8" hex bolt (9/16" hex)	94915-07	1	—	3
3/8" deep hex bolt (9/16" hex)	94916-07	—	—	—
1/4" hex bolt (7/16" hex)	94917-07	—	14	—
5/16" hex bolt (1/2" hex)	94918-07	4	10	8
1/2" hex bolt	94919-07	4	—	—
1/2" deep hex bolt	94920-07	1	—	—
7/16" hex bolt	94941-07	—	—	—
5/16" T40 Torx button head screw	94942-07	4	—	—

Notice: The prices appearing in this catalog are the manufacturer's suggested retail prices. Actual retail prices may vary.

ENGINE TRIM 569

Hardware Covers



B. CHROME SOCKET HEAD SCREW COVER KIT



B. CHROME SOCKET HEAD SCREW COVER KIT

Finish the show-winning look with these easy-to-install hardware covers. These machined brass and chrome-plated covers are corrosion resistant, and the internal spring steel retention clip resists vibration and thermal cycling to securely hold the covers in place.

94830-02		\$39.95
Fits 1/4" socket head screws with hex drive (pkg. of 10).		
94832-02		\$20.95
Fits 5/16" socket head screws with hex drive (pkg. of 4).		
94834-02		\$20.95
Fits 3/8" socket head screws with hex drive (pkg. of 4).		

C. CHROME ALLEN® HOLE PLUGS

94130-93T	1/4" (pkg. of 10).	\$7.95
94131-93T	5/16" (pkg. of 10).	\$7.95
94132-93T	3/8" (pkg. of 10).	\$7.95

D. CHROME H-D® MOTOR CO. LOGO ALLEN HOLE PLUGS

94527-95	1/4" (pkg. of 10).	\$9.95
94529-95	5/16" (pkg. of 10).	\$9.95
94531-95	3/8" (pkg. of 10).	\$9.95

E. CHROME HEX BOLT COVERS

Place over a variety of exposed bolts for a cleaner, detailed look. Compression clips for a secure fit. Sold in packages of 6 covers with retaining clips.

43881-96	Fits 1/2" hex bolts.	\$15.95
-----------------	----------------------	----------------

F. CHROME AIR CLEANER SCREW

Complete the chrome on your stock air cleaner cover with this chrome-plated stainless steel screw, which easily replaces the polished stock air cleaner screw.

29600-00	Fits stock Twin Cam engines (except CVO™ models).	\$5.95
29703-00	Fits stock Evolution® 1340 engines.	\$5.95

G. CHROME TIMER COVER SCREW KITS

Dress up accessory timer covers by replacing the stock zinc plate screws with brilliant chrome.

32690-99A	Fits Twin Cam 5-hole timer covers. Kit contains five chrome-plated button head Torx® screws.	\$13.95
94208-04	Fits '04-later XL, '18-later Softail® and '17-later Touring models.	\$6.95

H. CHROME DERBY COVER SCREW KIT

Dress up accessory derby covers by replacing the stock zinc-plated screws with brilliant chrome.

25913-99	Fits '99-later Dyna®, Softail, Touring and Trike models. Kit contains five chrome-plated button head Torx screws and five stainless steel washers.	\$15.95
94630-98	Fits Evolution 1340 models. Kit includes three button head Torx screws and oil seals.	\$13.95
94631-98	Fits '94-'03 XL models.	\$7.95
94207-04	Fits '04-later XL models.	\$15.95



C. CHROME ALLEN HOLE PLUGS



D. CHROME H-D MOTOR CO. LOGO ALLEN HOLE PLUGS



E. CHROME HEX BOLT COVERS



F. CHROME AIR CLEANER SCREW



G. CHROME TIMER COVER SCREW KIT – TWIN CAM SHOWN



H. CHROME DERBY COVER SCREW KIT – TWIN CAM SHOWN

Model Family Fitment:

 V-ROD	 SPORTSTER	 DYNA
 SOFTAIL	 TOURING	

Notice: The prices appearing in this catalog are the manufacturer's suggested retail prices. Actual retail prices may vary.

570 ENGINE TRIM

Chrome Hardware Kits

A. CHROME HARDWARE KIT – PRIMARY COVER

Kit includes the hardware required to replace the visible set of zinc-plated fasteners on the outer primary cover. Inspection and derby cover hardware included. Lock patch included where required.

94281-04 Fits '04-later XL models. **\$69.95**

94053-03A **\$69.95**

Fits '99-'05 Dyna® and '00-'06 Softail® models.

94052-03A Fits '99-'06 Touring models. **\$69.95**

B. CHROME HARDWARE KIT – GEARCASE/FRONT SPROCKET COVER

Kit includes the hardware required to replace the visible set of zinc-plated fasteners on the gearcase and front sprocket cover. Lock patch included where required.

94280-04 Fits '04-later XL models. **\$49.95**

C. CHROME HARDWARE KIT – TRANSMISSION

Kit includes the hardware required to replace the visible set of zinc-plated fasteners on the transmission top cover, bearing housing assembly and clutch release cover. Lock patch included where required.

94056-03 Fits '99-'05 Dyna models. **\$59.95**

94055-03 Fits '00-'06 Softail models. **\$59.95**

94054-03 Fits '99-'06 Touring models. **\$59.95**

34856-06A **\$59.95**

Fits '06-'17 Dyna and '07-'17 Softail and Touring models.

D. CHROME HARDWARE KIT – ROCKER BOX

Kit includes the hardware required to replace the visible set of zinc-plated fasteners on rocker box covers. Lock patch included where required.

94291-04A Fits '04-later XL models. **\$36.95**

94059-03 **\$36.95**

Fits '99-'17 Dyna, '00-'17 Softail, and '99-'16 Touring and Trike models.

E. CHROME HARDWARE KIT – CAM COVER

Kit includes the hardware required to replace the visible set of zinc-plated fasteners on the cam cover. Cam position sensor cover hardware included. Lock patch included where required.

94058-03 **\$34.95**

Fits '99-'17 Dyna, '00-'17 Softail, and '99-'16 Touring and Trike models.

F. CHROME HARDWARE KIT – LIFTER/TAPPET BLOCK

Kit includes the hardware required to replace the visible set of zinc-plated fasteners on lifter block covers. Lock patch included where required.

94068-03 **\$22.95**

Fits '99-'17 Dyna, '00-'17 Softail, and '99-'16 Touring and Trike models.



A. CHROME HARDWARE KIT – PRIMARY COVER (TOURING SHOWN)



B. CHROME HARDWARE KIT – GEARCASE/FRONT SPROCKET COVER



C. CHROME HARDWARE KIT – TRANSMISSION (SOFTAIL SHOWN)



D. CHROME HARDWARE KIT – ROCKER BOX (BIG TWIN SHOWN)

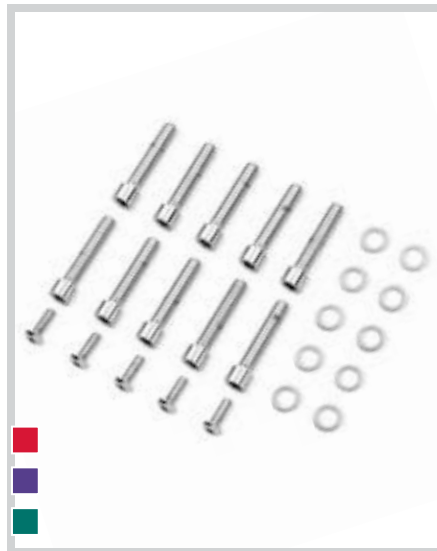

E. CHROME HARDWARE KIT – CAM COVER



F. CHROME HARDWARE KIT – LIFTER/TAPPET BLOCK (BIG TWIN SHOWN)

Model Family Fitment:

V-ROD
 SPORTSTER
 DYNA

 SOFTAIL
 TOURING

Notice: The prices appearing in this catalog are the manufacturer's suggested retail prices. Actual retail prices may vary.

ENGINE TRIM 571

Docking Hardware Covers



G. REAR DOCKING HARDWARE COVER KIT – CHROME



G. REAR DOCKING HARDWARE COVER KIT – BLACK

G. REAR DOCKING HARDWARE COVER KIT

Disguise the rear docking hardware with these easy-to-install covers. The caps slide over the exposed docking points, and are held in place by a strong magnetic pull. The caps are easy to remove when you wish to reinstall detachable accessories. Covers are available with brilliant chrome or durable gloss black finish to match your bike's attitude. Sold in pairs.

Fits many accessory docking hardware kits. Refer to the fitment matrix below or the Parts & Accessories section of www.harley-davidson.com for details.

48218-10	Short Chrome (pair).	\$34.95
48220-10	Large Chrome (pair).	\$34.95
48035-09	Small Chrome (pair).	\$34.95
48221-10	Short Black (pair).	\$34.95
48223-10	Large Black (pair).	\$34.95
48225-10	Small Black (pair).	\$34.95



Docking Kit Part Number	Fitment	Large Chrome: 48220-10 Black: 48223-10	Small Chrome: 48035-09 Black: 48225-10	Short Chrome: 48218-10 Black: 48221-10
XL Models				
53529-04	Fits '04-later XL (some black) models.	—	1	1
53528-95B	Fits '94-'03 XL (without bags) models.	1	1	—
53532-02	Fits '02-'03 XL (with bags) models.	1	—	—
90465-98A	Fits '94-'01 XL (with bags) models.	1	—	—
Dyna® Models				
53961-06	Fits '06-'17 Dyna® (FXD/L) models.	—	1	1
53964-06B	Fits '08-'17 FXDF, '09-'10 FXDFSE and '06-'08 FXDWG models.	—	1	1
54097-10	Fits '10-'17 FXDWG (black) models.	—	1	1
53797-09	Fits '09-'17 FXDB (black) models.	—	1	1
53858-01	Fits '96-'01 FXDWG (except FXDWG2) models.	1	—	—
Softail® Models				
53932-03A	Fits '03-'17 Softail® (without bags) models.	1	1	—
Touring Models				
52300131	Fits '14-later Touring (4pt) chrome models.	—	2	—
52300353	Fits '14-later Touring (4pt) chrome models	—	2	—
52300354	Fits '14-later Touring (4pt) black models	—	2	—
54205-09	Fits '09-'13 Touring (4pt) chrome models.	—	2	—
54246-09	Fits '09-'13 Touring (4pt) black models.	—	2	—
54030-09	Fits '09-'13 Touring (2pt) chrome models.	—	1	—
54249-09	Fits '09-'13 Touring (2pt) black models.	—	1	—
53803-06	Fits '97-'08 Touring (front) models.	—	1	—
53804-06	Fits '94-'08 Touring (rear) models.	1	1	—
53988-07	Fits '07-'08 FLHRSE3/4 models.	—	1	1

Notice: The prices appearing in this catalog are the manufacturer's suggested retail prices. Actual retail prices may vary.

572 ENGINE TRIM

Chrome Hardware

A. CHROME DOME HEX NUTS

Update the custom look with Chrome Dome hardware. These uniquely styled hex nuts bring a new look to the traditional acorn shape, and feature a low-profile design and a smooth chrome finish.

8067	7/16" – 20 thread (pkg. of 10).	\$1.95
8066	7/16" – 14 thread (pkg. of 10).	\$1.95
8065	3/8" – 24 thread (pkg. of 10).	\$1.95
8064	3/8" – 16 thread (pkg. of 10).	\$1.95
8063	5/16" – 24 thread (pkg. of 10).	\$1.95
8062	5/16" – 18 thread (pkg. of 10).	\$1.95
8061	1/4" – 28 thread (pkg. of 10).	\$1.95
8060	1/4" – 20 thread (pkg. of 10).	\$1.95
8071	10 – 24 thread (pkg. of 10).	\$1.95
8072	10 – 32 thread (pkg. of 10).	\$1.95
8073	1/2" – 13 thread (pkg. of 5).	\$2.95
8074	1/2" – 20 thread (pkg. of 5).	\$2.95



A. CHROME DOME HEX NUTS



A. CHROME DOME HEX NUTS

B. WINDSHIELD ACORN NUT KIT

Kit contains 10 chrome-plated low crown 12-24 acorn nuts.

94111-95 **\$9.95**

Fits Compact, King-Size, Convertible and Road King® windshields (pkg. of 10).



B. WINDSHIELD ACORN NUT KIT



C. CHROME ACORN NUT KITS

C. CHROME ACORN NUT KITS

94115-93T	10 – 24 thread (pkg. of 5).	\$5.95
94116-93T	10 – 32 thread (pkg. of 5).	\$5.95
94117-93T	1/4" – 20 thread (pkg. of 5).	\$5.95
94118-93T	1/4" – 28 thread (pkg. of 5).	\$5.95
94119-93T	5/16" – 18 thread (pkg. of 4).	\$5.95
94120-93T	5/16" – 24 thread (pkg. of 4).	\$5.95
94121-93T	3/8" – 16 thread (pkg. of 3).	\$5.95
94122-93T	3/8" – 24 thread (pkg. of 3).	\$5.95
94123-93T	7/16" – 14 thread (pkg. of 2).	\$5.95
94124-93T	7/16" – 20 thread (pkg. of 2).	\$5.95
94125-93T	1/2" – 13 thread (pkg. of 1).	\$5.95
94126-93T	1/2" – 20 thread (pkg. of 1).	\$5.95
94127-93T	5/8" – 18 thread (pkg. of 1).	\$5.95

D. CHROME TORX® BUTTON HEAD SCREWS

Available in 1/4-inch, 5/16-inch and 3/8-inch coarse thread, up to 2-1/4 inches long. Grade 8. See your Dealer for more information.

E. CHROME HEX SOCKET BUTTON HEAD SCREWS

Available in 8-32, 10-24, 10-32, 1/4-inch, 5/16-inch and 3/8-inch, up to 1 inch long. See your Dealer for more information.

F. CHROME TORX SOCKET HEAD SCREWS

Available in 1/4-inch, 5/16-inch and 3/8-inch coarse thread, up to 2-1/4 inches long. Grade 8. See your Dealer for more information.

G. CHROME SOCKET HEAD SCREWS

Available in 1/4-inch, 5/16-inch and 3/8-inch coarse and fine thread, up to 3 inches long. See your Dealer for more information.

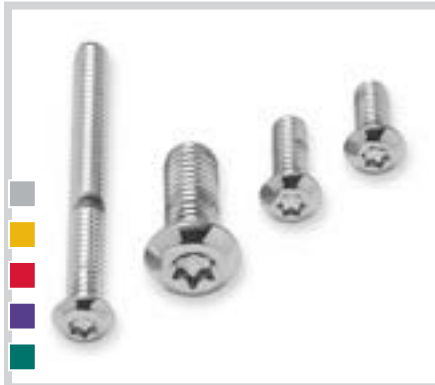

D. CHROME TORX BUTTON HEAD SCREWS



E. CHROME HEX SOCKET BUTTON HEAD SCREWS



F. CHROME TORX SOCKET HEAD SCREWS



G. CHROME SOCKET HEAD SCREWS

Notice: The prices appearing in this catalog are the manufacturer's suggested retail prices. Actual retail prices may vary.

ENGINE TRIM 573

Chrome Hardware



H. CHROME SMOOTH SOCKET HEAD SCREWS



I. CHROME HEX HEAD SCREWS



J. CHROME 12-POINT SCREWS



K. CHROME FLAT-HEAD SCREWS



L. CHROME LOCK NUTS WITH NYLON INSERTS



M. CHROME HEX NUTS



N. CHROME FLAT WASHERS



O. CHROME LOCK WASHERS

H. CHROME SMOOTH SOCKET HEAD SCREWS

Available in 1/4-inch, 5/16-inch and 3/8-inch coarse and fine thread, up to 3 inches long. See your Dealer for more information.

I. CHROME HEX HEAD SCREWS

Available in 1/4-inch, 5/16-inch and 3/8-inch coarse and fine thread, up to 3 inches long. See your Dealer for more information.

J. CHROME 12-POINT SCREWS

Available in 1/4-inch, 5/16-inch and 3/8-inch coarse thread, up to 2-1/4 inches long. Grade 8. See your Dealer for more information.

K. CHROME FLAT-HEAD SCREWS

When the details matter, even your screws are chromed. These Grade 8 Hex Drive screws are available in 17 different sizes. See your Dealer for more information.

L. CHROME LOCK NUTS WITH NYLON INSERTS

Available in 10-24, 1/4-inch, 5/16-inch, 3/8-inch, 7/16-inch and 5/8-inch sizes, coarse and fine thread. See your Dealer for more information.

M. CHROME HEX NUTS

Available in 1/4-inch, 5/16-inch and 3/8-inch sizes, coarse and fine thread. See your Dealer for more information.

N. CHROME FLAT WASHERS

Available in 1/4-inch, 5/16-inch and 3/8-inch sizes. See your Dealer for more information.

O. CHROME LOCK WASHERS

Available in 1/4-inch, 5/16-inch and 3/8-inch sizes. See your Dealer for more information.

Model Family Fitment:

- V-ROD
- SPORTSTER
- DYNA
- SOFTAIL
- TOURING

Notice: The prices appearing in this catalog are the manufacturer's suggested retail prices. Actual retail prices may vary.

CONTROLS

The most visual contact point you have with your motorcycle is where your hands and feet meet the controls. Choose a handlebar suitable for your physical needs. Then select grips, hand controls, footpegs and mirrors to underscore the style of your ride.



TOUCH POINTS

From a rider's perspective, the controls are one of the most visual parts of the bike. They are the first thing you touch when you drop into the saddle, and what you see every mile you ride. That makes your controls a prime candidate for special treatment. Styled to put an integrated look just a few wrench turns away, installing one of our hand and foot control collections is a solid first step to an all-out custom journey.



HAND & FOOT CONTROL COLLECTIONS



DOMINION™
Gloss Black Anodized
SEE PAGE 580



DOMINION
Bronze Powder Coated
SEE PAGE 581



KAHUNA™
Gloss Black
SEE PAGE 584



KAHUNA
Chrome
SEE PAGE 585



DEFIANCE
Black Machined
SEE PAGES 586-587



DEFIANCE
Black
SEE PAGES 588-589



DEFIANCE
Chrome
SEE PAGES 590-591



EDGE CUT
SEE PAGES 592-593



BRASS
SEE PAGES 594-595



WILLIE G. SKULL
SEE PAGES 596-597



AIRFLOW
Chrome
SEE PAGE 598



AIRFLOW
Gloss Black
SEE PAGE 599



DIAMOND BLACK
SEE PAGE 600



BURST
SEE PAGE 601



CHROME & RUBBER
SEE PAGE 602



NOSTALGIC
SEE PAGE 603



STREAMLINER
SEE PAGE 604



CRESTED
SEE PAGE 605



GET A GRIP
Chrome
SEE PAGE 608



GET A GRIP
Black
SEE PAGE 608

DOMINION™ COLLECTION

The premium, leading-edge Dominion™ collection was created to take your bike to a new level of customization. This robust, but simple system is offered in gloss black anodized or bronze powder coated base components and features interchangeable accent pieces to kick your bike into high gear.



2019 Fat Bob® customized with H-D® Genuine Motor Parts & Accessories







STEP 1 | SELECT DOMINION™ ENGINE COMPONENTS (GLOSS BLACK ANODIZED OR BRONZE POWDER COATED)

GLOSS BLACK ANODIZED - with Machined Aluminum Highlights

 Upper Rocker Box Covers	 Primary Cover* <i>*shown with Brushed Aluminum HDMC Insert</i>	
 Cam Cover	 Transmission Side Cover	 Derby Cover

BRONZE POWDER COATED - with Machined Aluminum Highlights







 Upper Rocker Box Covers	 Primary Cover* <i>*shown with Brushed Aluminum HDMC Insert</i>	
 Cam Cover	 Transmission Side Cover	 Derby Cover

STEP 2 | SELECT DOMINION FOOT CONTROLS (GLOSS BLACK ANODIZED OR BRONZE POWDER COATED)

GLOSS BLACK ANODIZED - with Brushed Black Inserts

 Footboards	 Small Footpegs	 Large Footpegs
 Large Brake Pedal	 Small Brake Pedal	 Shifter Peg

BRONZE POWDER COATED - with Bronze Powder Coated Inserts













 Footboards	 Small Footpegs	 Large Footpegs
 Large Brake Pedal	 Small Brake Pedal	 Shifter Peg

STEP 3 | SELECT DOMINION ACCENT COLOR (Brushed Black, Bronze Powder Coated, Brushed Orange Anodized, Brushed Black HDMC, Brushed Aluminum)

ENGINE COMPONENT INSERTS - Mix and Match

FOOT CONTROL INSERTS - Mix and Match

STEP 4 | SELECT ADDITIONAL DOMINION PRODUCTS TO COMPLETE THE LOOK

HAND GRIPS

	
---	---

MIRRORS

	
---	---

FUEL CAP

	
---	--

AXLE, FORK NUT, STEERING STEM COVERS

	
---	---

580 CONTROLS

Hand & Foot Controls Collection

DOMINION™ COLLECTION – BLACK

Express your bold, renegade attitude. The Dominion™ Collection Rider and Passenger Controls let you set your own styling direction. Crafted from aluminum, these hand and foot controls feature a rugged machined surface and the foot controls allow for interchangeable inserts in brushed black, bronze powder-coated, brushed aluminum or brushed orange anodized inserts (sold separately) that allow you to create your own unique look.

A. DOMINION COLLECTION HAND GRIPS – BLACK

56100233 \$89.95

Fits '15-later XG models (except XG750A).

56100232 \$129.95

Fits '02-'17 VRSC™, '96-later XL, '08-'13 XR, '91-'17 Dyna® (except FXDLS), '96-'15 Softail® (except FLSTNSE, FXSBSE and '11-'12 FLSTSE) and '96-'07 Touring models.

56100231 \$129.95

Fits '16-'17 FXDLS and '16-later Softail models; '11-'12 FLSTSE, '14-'15 FLSTNSE, '13-'14 FXSBSE, '16-'17 FXSE and '08-later Touring (except '18-later FLTRXSE) and Trike models.

B. DOMINION COLLECTION RIDER FOOTBOARD KIT – BLACK

50500869 Rider. \$399.95

Fits '18-later FL Softail models equipped with rider footboards.

C. DOMINION COLLECTION BRAKE PEDAL PADS – BLACK

50600267 Small. \$49.95

Fits '18-later FL SB, FXBR and FXBRS models. Also fits '18-later Softail models equipped with Billet Style Rear Brake Lever for Forward Controls P/N 41600218, 41600219 and 41600220.

50600266 Large. \$64.95

Fits '18-later FL Softail models equipped with rider footboards.

D. DOMINION COLLECTION FOOTPEGS – BLACK

50500947 With Removable Wear Peg. \$149.95

Fits models with H-D® male mount-style footpeg supports (except rider position on '17-later XG750A, '07-'10 XL883L, '07-later XL883N, XL1200N, XL1200V and XL1200X, '11-later XL1200C and XL1200T, '18-later XL1200NS and XL1200XS, '08-'13 XR and '08-'17 FXCW, FXCWC, FXS, FXSB, FXSE and FXSBSE models and the rider and passenger position on '18-later Softail models).

50500870 Rider. \$149.95

Fits rider position on '18-later FXFB, FXFBS and '19-later FXDRS models.

50500871 Rider. \$149.95

Fits rider position on '18-later FLSB, FXBB, FXBR, FXBRS and FXLR models.

50501558 Passenger. \$149.95

Fits models in passenger and highway peg positions. Does not fit the rider and passenger position for '18-later Softail models.

50500992 Passenger. \$149.95

Fits passenger position on '18-later Softail models.

E. DOMINION COLLECTION SHIFTER PEG – BLACK

33600180 \$39.95

Fits all models (except '06-'17 VRSC models with forward controls and '08-'13 XR models).



A. DOMINION HAND GRIPS – BLACK



B. DOMINION RIDER FOOTBOARD – BLACK



C. DOMINION BRAKE PEDAL PADS – BLACK

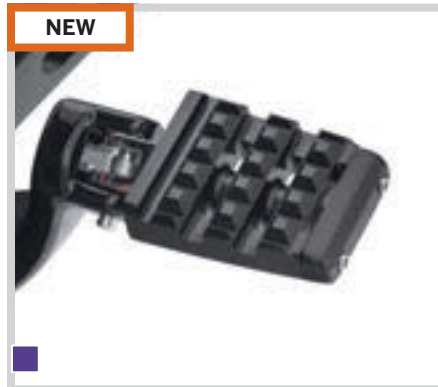

D. DOMINION FOOTPEGS – BLACK
(50500870 SHOWN)



D. DOMINION FOOTPEGS – BLACK



D. DOMINION FOOTPEGS – BLACK



E. DOMINION SHIFTER PEG – BLACK

Notice: The prices appearing in this catalog are the manufacturer's suggested retail prices. Actual retail prices may vary.

CONTROLS 581

Hand & Foot Controls Collection

CONTROLS



F. DOMINION HAND GRIPS – BRONZE

DOMINION™ COLLECTION – BRONZE

Express your bold, renegade attitude. The Dominion™ Collection Rider and Passenger Controls let you set your own styling direction. Crafted from aluminum, these hand and foot controls feature a rugged machined surface and the foot controls allow for interchangeable inserts in brushed black, bronze powder-coated, brushed aluminum or brushed orange anodized inserts (sold separately) that allow you to create your own unique look.

F. DOMINION COLLECTION HAND GRIPS – BRONZE

56100236 **\$89.95**

Fits '15-later XG models (except XG750A).

56100235 **\$129.95**

Fits '02-'17 VRSC™, '96-later XL, '08-'13 XR, '91-'17 Dyna® (except FXDLS), '96-'15 Softail® (except FLSTNSE, FXSBSE and '11-'12 FLSTSE) and '96-'07 Touring models.

56100234 **\$129.95**

Fits '16-'17 FXDLS and '16-later Softail models, '11-'12 FLSTSE, '14-'15 FLSTNSE, '13-'14 FXSBSE, '16-'17 FXSE and '08-later Touring (except '18-later FLTRXSE) and Trike models.

G. DOMINION COLLECTION RIDER FOOTBOARD KIT – BRONZE

50500872 Rider. **\$399.95**

Fits '18-later FL Softail models equipped with rider footboards.

H. DOMINION COLLECTION BRAKE PEDAL PADS – BRONZE

50600269 Small. **\$49.95**

Fits '18-later FL SB, FXBR and FXBRS models. Also fits '18-later Softail models equipped with Billet Style Rear Brake Lever for Forward Controls P/N 41600218, 41600219 and 41600220.

50600268 Large. **\$64.95**

Fits '18-later FL Softail models equipped with rider footboards.

I. DOMINION COLLECTION FOOTPEGS – BRONZE

50500949 With Removable Wear Peg. **\$149.95**

Fits models with H-D® male mount-style footpeg supports (except rider position on '17-later XG750A, '07-'10 XL883L, '07-later XL883N, XL1200N, XL1200V and XL1200X, '11-later XL1200C and XL1200T, '18-later XL1200NS and XL1200XS, '08-'13 XR and '08-'17 FXCW, FXCWC, FXS, FXSB, FXSE and FXSBSE models and the rider and passenger position on '18-later Softail models).

50500873 Rider. **\$149.95**

Fits rider position on '18-later FXFB, FXFBS and '19-later FXDRS models.

50500874 Rider. **\$149.95**

Fits rider position on '18-later FL SB, FXBB, FXBR, FXBRS and FXLR models.

50501559 Passenger. **\$149.95**

Fits models in passenger and highway peg positions. Does not fit the rider and passenger position for '18-later Softail models.

50500993 Passenger. **\$149.95**

Fits passenger position on '18-later Softail models.

J. DOMINION COLLECTION SHIFTER PEG – BRONZE

33600214 **\$39.95**

Fits all models (except '06-'17 VRSC models with forward controls and '08-'13 XR models).



G. DOMINION RIDER FOOTBOARD – BRONZE



H. DOMINION BRAKE PEDAL PADS – BRONZE



I. DOMINION FOOTPEGS – BRONZE
(50500873 SHOWN)



I. DOMINION FOOTPEGS – BRONZE



I. DOMINION FOOTPEGS – BRONZE



J. DOMINION SHIFTER PEG – BRONZE

Model Family Fitment:

- V-ROD
- SPORTSTER
- DYNA
- SOFTAIL
- TOURING

Notice: The prices appearing in this catalog are the manufacturer's suggested retail prices. Actual retail prices may vary.

582 CONTROLS

Hand & Foot Controls Collection

DOMINION™ COLLECTION FOOT CONTROL INSERTS
 Make your bike a true custom of one. The Dominion™ Inserts allow you to customize and personalize Dominion Collection accessories, so your bike is truly one of a kind.

A. DOMINION COLLECTION RIDER FOOTBOARD TRIM PIECE

Fits Dominion Rider Footboard Kits P/N 50500869 and 50500872. Sold in sets of 2.

50500928	Brushed Black.	\$39.95
50500929	Bronze.	\$39.95
50500930	Brushed Orange.	\$39.95
50500931	Brushed Aluminum.	\$39.95

B. DOMINION COLLECTION FOOTPEG TRIM PIECE

Fits Dominion Footpegs. Sold in sets of 2.

50500937	Brushed Black.	\$29.95
50500938	Bronze.	\$29.95
50500939	Brushed Orange.	\$29.95
50500940	Brushed Aluminum.	\$24.95

C. DOMINION COLLECTION SHIFTER PEG TRIM PIECE

Fits Dominion Shifter Pegs P/N 33600180 and 33600214.

33600215	Brushed Black.	\$14.95
33600216	Bronze.	\$14.95
33600217	Brushed Orange.	\$14.95
33600218	Brushed Aluminum.	\$14.95

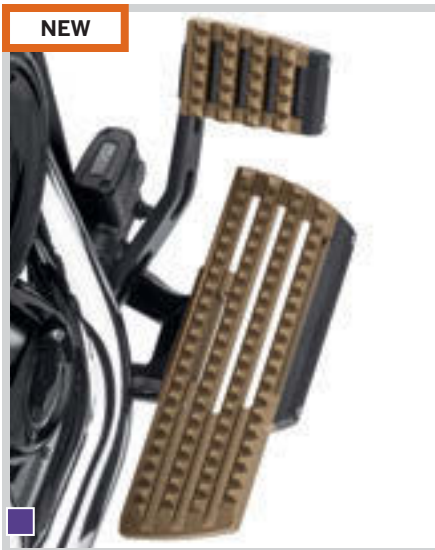

A. DOMINION RIDER FOOTBOARD TRIM PIECE – BLACK (SHOWN WITH LARGE BRAKE PEDAL & TRIM)



A. DOMINION RIDER FOOTBOARD TRIM PIECE

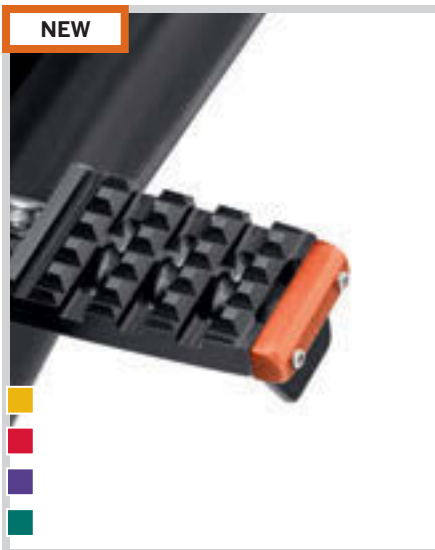

B. DOMINION FOOTPEG TRIM (ORANGE SHOWN)



B. DOMINION FOOTPEG TRIM



C. DOMINION SHIFTER PEG TRIM – ALUMINUM ON BLACK



C. DOMINION SHIFTER PEG TRIM

Notice: The prices appearing in this catalog are the manufacturer's suggested retail prices. Actual retail prices may vary.

CONTROLS 583

Hand & Foot Controls Collection

CONTROLS

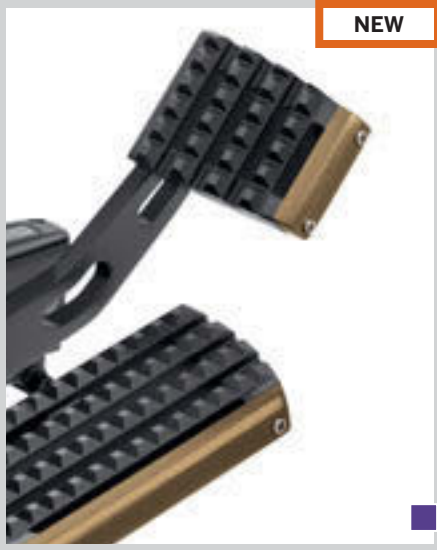

NEW

D. DOMINION LARGE BRAKE PEDAL TRIM – BRONZE
(SHOWN WITH RIDER FOOTBOARD & TRIM)



NEW

D. DOMINION LARGE BRAKE PEDAL TRIM

D. DOMINION™ COLLECTION TRIM PIECE – LARGE BRAKE PEDAL

Fits Dominion™ Large Brake Pedal Pads P/Ns 50600266 and 50600268.

50600290	Brushed Black.	\$29.95
50600291	Bronze	\$29.95
50600292	Brushed Orange.	\$29.95
50600293	Brushed Aluminum.	\$29.95

E. DOMINION COLLECTION TRIM PIECE – SMALL BRAKE PEDAL

Fits Dominion Small Brake Pedal Pads P/Ns 50600267 and 50600269.

50600294	Brushed Black.	\$24.95
50600295	Bronze.	\$24.95
50600296	Brushed Orange.	\$24.95
50600297	Brushed Aluminum.	\$24.95



NEW

E. DOMINION SMALL BRAKE PEDAL TRIM – BLACK
(SHOWN ON BRONZE BRAKE PEDAL PAD)



NEW

E. DOMINION SMALL BRAKE PEDAL TRIM



NEW

DOMINION COLLECTION TRIM – ALUMINUM ON BRONZE

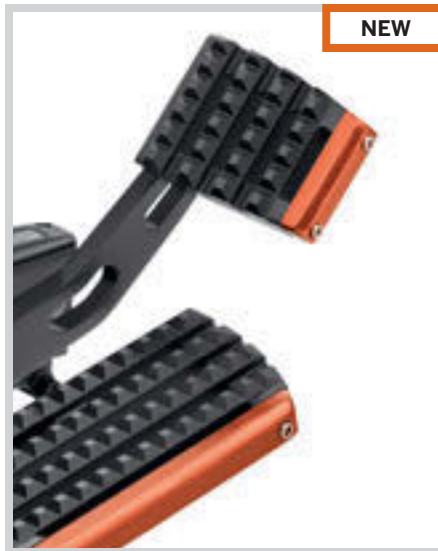

NEW

DOMINION COLLECTION TRIM – ORANGE ON BLACK

Model Family Fitment:

- V-ROD
- SPORTSTER
- DYNA
- SOFTAIL
- TOURING

Notice: The prices appearing in this catalog are the manufacturer's suggested retail prices. Actual retail prices may vary.

584 CONTROLS

Hand & Foot Controls Collection

KAHUNA™ COLLECTION HAND AND FOOT CONTROLS – GLOSS BLACK

Understated but powerful, The Kahuna™ Collection Controls feature a gloss black surfaces surrounded by rich, black rubber that provides grip and traction where needed. These gloss black controls are styled to complement other Kahuna Collection Accessories and the Hand Grips and Rider Footboards also feature a rich red Bar & Shield logo.

A. KAHUNA COLLECTION HAND GRIPS – GLOSS BLACK

56100332 **\$139.95**
Fits '16-'17 FXDLS and '16-later Softail® models, '11-'12 FLSTSE, '14-'15 FLSTNSE, '13-'14 FXSBSE, '16-'17 FXSE and '08-later Touring (except '18-later FLTRXSE) and Trike models.



A. KAHUNA HAND GRIPS – GLOSS BLACK

B. KAHUNA COLLECTION FOOTPEGS – GLOSS BLACK

50501225 **\$139.95**
Fits rider position: '02-'17 VRSC™ models with forward controls (except VRSCDX and VRSCF), '15-later XG models (except XG750A), '06-earlier XL, '07-'10 XL883, XL883C, XL883R, XL1200C and XL1200R, '07-'11 XL1200L, '91-'17 Dyna® (except FLD), and '84-'17 Softail models with forward controls (except FXCW, FXCWC, FXS, FXSB or FXBSE). Fits passenger position: All models with H-D® male-mount passenger peg mounts (except '06-earlier VRSC, '03-earlier XL, '05-earlier Dyna and Softail models equipped with Shotgun exhaust). '84-'17 Softail models require separate purchase of Support Kit P/N 50454-09. Does not fit passenger position on '18-later Softail models. Fits highway peg position: All models with frame-mount or engine guard-mount highway pegs (except Whiskers Adjustable Highway Bar P/N 50855-09 and 50865-09).



B. KAHUNA FOOTPEGS – GLOSS BLACK

C. KAHUNA COLLECTION SHIFTER PEG – GLOSS BLACK

33600257 **\$39.95**
Fits all models (except '06-'17 VRSC models with forward controls and '08-'13 XR models).



B. KAHUNA FOOTPEG AND SHIFTER PEG – GLOSS BLACK

D. KAHUNA COLLECTION BRAKE PEDAL PAD – GLOSS BLACK

50600341 Large. **\$59.95**
Fits '12-'16 FLD, '86-'17 FL Softail and '80-later Touring and Trike models.



D. KAHUNA SHIFTER PEG – GLOSS BLACK

E. KAHUNA COLLECTION FOOTBOARD KITS – GLOSS BLACK

50501227 Rider. **\$349.95**
Fits '12-'16 FLD, '86-'17 FL Softail (except FLS, FLSS, FLSTFB, FLSTFBS and FXSE), '86-later Touring and '08-later Trike models.

50501228 Passenger. **\$349.95**
Fits '06-'17 Dyna, '00-'17 Softail and '86-later Touring models equipped with passenger footboard supports. Does not fit Trike models.



D. KAHUNA BRAKE PEDAL PAD – GLOSS BLACK



D. KAHUNA RIDER FOOTBOARDS KIT – GLOSS BLACK
(SHOWN WITH LARGE BRAKE PEDAL PAD)



E. KAHUNA PASSENGER FOOTBOARD KIT – GLOSS BLACK

Notice: The prices appearing in this catalog are the manufacturer's suggested retail prices. Actual retail prices may vary.

CONTROLS 585

Hand & Foot Controls Collection

CONTROLS



NEW

F. KAHUNA HAND GRIPS – CHROME

KAHUNA™ COLLECTION HAND AND FOOT CONTROLS – CHROME

Understated but powerful, The Kahuna™ Collection Controls feature a mirror-like chrome surface surrounded by rich, black rubber that provides grip and traction where needed. These chrome controls are styled to complement other Kahuna Collection Accessories and the Hand Grips and Rider Footboards also feature a rich red Bar & Shield logo.

F. KAHUNA COLLECTION HAND GRIPS – CHROME

56100319 **\$109.95**

Fits '16-'17 FXDLS and '16-later Softail® models, '11-'12 FLSTSE, '14-'15 FLSTNSE, '13-'14 FXSBSE, '16-'17 FXSE and '08-later Touring (except '18-later FLTRXSE) and Trike models.

G. KAHUNA COLLECTION FOOTPEGS – CHROME

50501148 **\$139.95**

Fits rider position: '02-'17 VRSC™ models with forward controls (except VRSCDX and VRSCF), '15-later XG models (except XG750A), '06-earlier XL, '07-'10 XL883, XL883C, XL883R, XL1200C and XL1200R, '07-'11 XL1200L, '91-'17 Dyna® (except FLD), and '84-'17 Softail models with forward controls (except FXCW, FXCWC, FXS, FXSB or FXBSE). Fits passenger position: All models with H-D® male-mount passenger peg mounts (except '06-earlier VRSC, '03-earlier XL, '05-earlier Dyna and Softail models equipped with Shotgun exhaust). '84-'17 Softail models require separate purchase of Support Kit P/N 50454-09. Does not fit passenger position on '18-later Softail models. Fits highway peg position: All models with frame-mount or engine guard-mount highway pegs (except Whiskers Adjustable Highway Bar P/N 50855-09 and 50865-09).

H. KAHUNA COLLECTION SHIFTER PEG – CHROME

33600256 **\$39.95**

Fits all models (except '06-'17 VRSC models with forward controls and '08-'13 XR models).

I. KAHUNA COLLECTION BRAKE PEDAL PAD – CHROME

50600340 Large. **\$59.95**

Fits '12-'16 FLD, '86-'17 FL Softail and '80-later Touring and Trike models.

J. KAHUNA COLLECTION FOOTBOARD KITS – CHROME

50501150 Rider. **\$349.95**

Fits '12-'16 FLD, '86-'17 FL Softail (except FLS, FLSS, FLSTFB, FLSTFBS and FXSE), '86-later Touring and '08-later Trike models.

50501151 Passenger. **\$349.95**

Fits '06-'17 Dyna, '00-'17 Softail and '86-later Touring models equipped with passenger footboard supports. Does not fit Trike models.



NEW

G. KAHUNA FOOTPEGS – CHROME



NEW

G. KAHUNA FOOTPEG AND SHIFTER PEG – CHROME



NEW

H. KAHUNA SHIFTER PEG – CHROME



NEW

I. KAHUNA BRAKE PEDAL PAD – CHROME

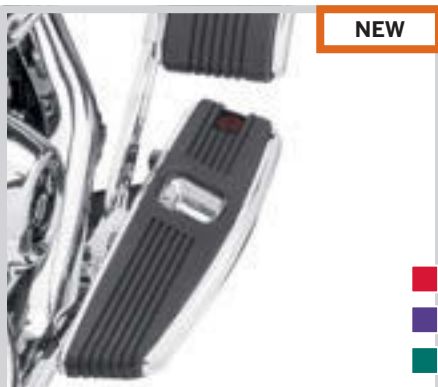

NEW

J. KAHUNA RIDER FOOTBOARDS KIT – CHROME (SHOWN WITH LARGE BRAKE PEDAL PAD)



NEW

J. KAHUNA PASSENGER FOOTBOARD KIT – CHROME

Model Family Fitment:

V-ROD
 SPORTSTER
 DYNA

 SOFTAIL
 TOURING

Notice: The prices appearing in this catalog are the manufacturer's suggested retail prices. Actual retail prices may vary.

586 CONTROLS

Hand & Foot Controls Collection

DEFIANCE COLLECTION – BLACK ANODIZED MACHINE CUT

Anything but traditional, this complete collection of hand and foot controls refuses to conform to everyday norms. The sweeping curves and perforated rubber define the look, and the rich contrasting finishes set the tone. The machine-cut Defiance Collection features deep grooves milled into the black anodized surface that exposes the shimmering aluminum below.

A. DEFIANCE HAND GRIPS – MACHINE CUT

The comfortable 1.5" diameter grips are easy to install, and incorporate a glueless design that allows you to remove the grips for service without damage.

56100223 **\$99.95**
Fits '15-later XG models (except XG750A).

56100175 **\$139.95**
Fits '02-'17 VRSC™, '96-later XL, '08-'13 XR, '91-'17 Dyna® (except FXDLS), '95-'15 Softail® (except FLSTNSE, FLSTSE, FXSBSE and '11-'12 FLSTSE) and '96-'07 Touring models.

56100174 **\$139.95**
Fits '16-'17 Dyna FXDLS and '16-later Softail models, '14-'15 FLSTNSE, '11-'12 FLSTSE, '13-'14 FXSBSE, and '08-later Touring and Trike models.



A. DEFIANCE HAND GRIPS – BLACK ANODIZED MACHINE CUT

B. DEFIANCE BRAKE PEDAL PADS – MACHINE CUT

This stylish brake pedal pad features a rich black rubber panel set into the recessed surface, surrounded by deep accent grooves.

50600188 Small. **\$54.95**
Fits '15-later XG models (except XG750A), '14-later XL models with Extended Reach Forward Control Kit P/N 50700030, '93-'17 Dyna models with forward controls, and '84-'17 FX Softail models (except FXSTDSE).

50600255 Small. **\$54.95**
Fits '18-later FXBR, FXBRS and FLSB models. Also fits '18-later Softail models equipped with Billet Style Rear Brake Lever for Forward Controls P/N 41600218, 41600219 and 41600220.

50600186 Large. **\$69.95**
Fits '12-'16 FLD, '86-'17 FL Softail and '80-later Touring and Trike models.

50600258 Large. **\$64.95**
Fits '18-later FL Softail models equipped with rider footboards.

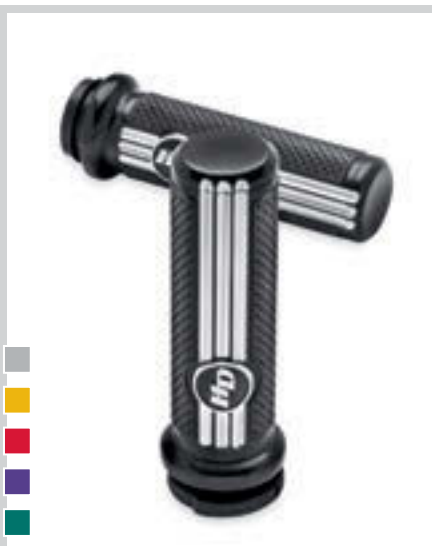

A. DEFIANCE HAND GRIPS – BLACK ANODIZED MACHINE CUT



B. DEFIANCE BRAKE PEDAL PADS – BLACK ANODIZED MACHINE CUT

C. DEFIANCE FOOTBOARD KIT – MACHINE CUT

These extended length sweeping shark-fin footboards are shaped to maintain a long and lean appearance while offering plenty of options for foot repositioning while riding. The aluminum footboards feature an elegant perforated rubber pad recessed into the surface, surrounded by deep grooves and a contemporary H-D logo. Kit includes left and right boards.

50500527 Rider. **\$429.95**
Fits '12-'16 FLD, '00-'17 FL Softail, '00-later Touring (except FLHTCUL and FLHTKL), and '09-'13 Trike models. Installation on '00-'17 Softail FLS, FLSS, FLSTFB, FLSTFBS and FLSTN models requires separate purchase of Jiffy Stand P/N 50087-07A. Not for use with Ergo Jiffy Stand P/N 50000091 or Jiffy Stand Extension Kit P/N 50233-00, 50000008 or 50000023.

50500798 Rider. **\$429.95**
Fits '18-later FL Softail models equipped with rider footboards.

50500528 Passenger. **\$319.95**
Fits '06-'17 Dyna, '00-later Softail (except FXDRS) and '86-later Touring models equipped with passenger footboard support. Does not fit Trike Models.



C. DEFIANCE RIDER FOOTBOARD KIT – BLACK ANODIZED MACHINE CUT



C. DEFIANCE PASSENGER FOOTBOARD KIT – BLACK ANODIZED MACHINE CUT

Notice: The prices appearing in this catalog are the manufacturer's suggested retail prices. Actual retail prices may vary.

CONTROLS 587

Hand & Foot Controls Collection



D. DEFIANCE FOOTPEGS – MACHINE CUT



D. DEFIANCE FOOTPEGS – MACHINE CUT
(50500540 SHOWN)



D. DEFIANCE FOOTPEGS – MACHINE CUT
(50500536 SHOWN)



D. DEFIANCE FOOTPEGS – MACHINE CUT
(50500807 SHOWN)



D. DEFIANCE FOOTPEGS – MACHINE CUT
(50500804 SHOWN)



D. DEFIANCE FOOTPEGS – MACHINE CUT
(50501009 SHOWN)



D. DEFIANCE FOOTPEGS – MACHINE CUT
(50500832 SHOWN)



E. DEFIANCE SHIFTER PEG – BLACK ANODIZED
MACHINE CUT

D. DEFIANCE FOOTPEGS – MACHINE CUT

Topped with high-traction rubber, these custom aluminum footpegs feature a pattern of deep lateral grooves and a stylized H-D logo for a modern sleek look.

50500540 **\$139.95**

Fits models with H-D® male mount-style footpeg supports (except rider position on '17-later XG750A, '07-'10 XL883L, '07-later XL883N, XL1200N, XL1200V and XL1200X, '11-later XL1200C and XL1200T, '18-later XL1200NS and XL1200XS, '08-'13 XR and '08-'17 FXCW, FXCWC, FXS, FXSB, FXSE and FXSBSE models and the rider and passenger position on '18-later Softail® models).

50500536 With Removable Wear Peg. **\$139.95**

Fits '11-later XL883L and XL1200C, '12-'16 XL1200V, '10-later XL1200X, '18-later XL1200XS, '14-later XL models equipped with Extended Reach Forward Control Conversion Kit P/N 50700030, '08-'11 FXCW and FXCWC, '11-'17 FXS and FXSB, and '16-'17 FXSE models.

50500807 Rider Footpegs with Removable Wear Peg. **\$139.95**

Fits rider position on '18-later FXBR and FXBRS models.

50500804 Rider Footpegs. **\$139.95**

Fits rider position on '18-later FLSB, FXBB and FXLR models.

50501009 Rider Footpegs. **\$139.95**

Fits rider position on '18-later FXFB, FXFBS and '19-later FXDRS models.

50500832 Passenger Footpegs. **\$139.95**

Fits passenger position on '18-later Softail models.

E. DEFIANCE SHIFTER PEG – BLACK ANODIZED

Wrapped in perforated rubber, these easy-to-install shifter pegs protect your boot leather when shifting and add a clean contemporary look to your ride.

33600111 **\$39.95**

Fits all models (except '06-'17 VRSC™ models with forward controls and '08-'13 XR models).

Model Family Fitment:

- V-ROD
- SPORTSTER
- DYNA
- SOFTAIL
- TOURING

Notice: The prices appearing in this catalog are the manufacturer's suggested retail prices. Actual retail prices may vary.

588 CONTROLS

Hand & Foot Controls Collection

DEFIANCE COLLECTION – BLACK ANODIZED

Show your complete disregard for the rules. Defined by sweeping curves, this complete assortment of hand and foot controls feature a rich tuxedo black finish that is the perfect complement to your sinister ride. The design incorporates a field of textured black rubber surrounded with deep longitudinal lines, and is finished with a contemporary H-D logo.

A. DEFIANCE HAND GRIPS – BLACK ANODIZED

The comfortable 1.5" diameter grips are easy to install, and incorporate a glueless design that allows you to remove the grips for service without damage.

56100224 **\$89.95**
Fits '15-later XG models (except XG750A).

56100159 **\$129.95**
Fits '02-'17 VRSC™, '96-later XL, '08-'13 XR '91-'17 Dyna® (except FXDLS), '95-'15 Softail® (except FLSTNSE, FLSTSE, FXSBSE and '11-'12 FLSTSE) and '96-'07 Touring models.

56100157 **\$129.95**
Fits '16-'17 Dyna FXDLS and '16-later Softail models, '14-'15 FLSTNSE, '11-'12 FLSTSE, '13-'14 FXSBSE, and '08-later Touring and Trike models.



A. DEFIANCE HAND GRIPS – BLACK ANODIZED

B. DEFIANCE BRAKE PEDAL PADS – BLACK ANODIZED

This stylish brake pedal pad features a rich black rubber panel set into the recessed surface, surrounded by deep accent grooves.

50600187 Small. **\$49.95**
Fits '15-later XG models (except XG750A), '14-later XL models with Extended Reach Forward Control Kit P/N 50700030, '93-'17 Dyna models with forward controls, and '84-'17 FX Softail models (except FXSTDSE).

50600256 Small. **\$49.95**
Fits '18-later FXBR, FXBRS and FLSB models. Also fits '18-later Softail models equipped with Billet Style Rear Brake Lever for Forward Controls P/N 41600218, 41600219 and 41600220.

50600185 Large. **\$64.95**
Fits '12-'16 FLD, '86-'17 FL Softail and '80-later Touring and Trike models.

50600259 Large. **\$59.95**
Fits '18-later FL Softail models equipped with rider footboards.

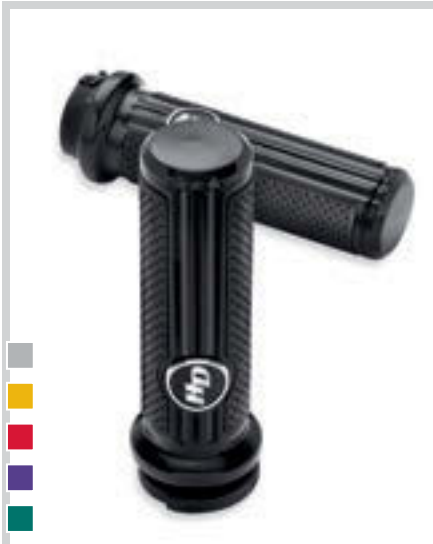

A. DEFIANCE HAND GRIPS – BLACK ANODIZED



B. DEFIANCE BRAKE PEDAL PADS – BLACK ANODIZED

C. DEFIANCE FOOTBOARD KIT – BLACK ANODIZED

These extended length sweeping shark-fin footboards are shaped to maintain a long and lean appearance while offering plenty of options for foot repositioning while riding. The aluminum footboards feature an elegant perforated rubber pad recessed into the surface, surrounded by deep grooves and a contemporary H-D logo. Kit includes left and right boards.

50500640 Rider. **\$399.95**
Fits '12-'16 FLD, '00-'17 FL Softail, '00-later Touring (except FLHTCUL and FLHTKL), and '09-'13 Trike models. Installation on '05-'17 Softail FLS, FLSS, FLSTFB, FLSTFBS and FLSTN models requires separate purchase of Jiffy Stand P/N 50087-07A. Not for use with Ergo Jiffy Stand P/N 50000091 or Jiffy Stand Extension Kit P/N 50233-00, 50000008 or 50000023.

50500799 Rider. **\$399.95**
Fits '18-later FL Softail models equipped with rider footboards.

50500667 Passenger. **\$299.95**
Fits '06-'17 Dyna, '00-later Softail (except FXDRS) and '86-later Touring models equipped with passenger footboard support. Does not fit Trike Models.



C. DEFIANCE RIDER FOOTBOARD KIT – BLACK ANODIZED



C. DEFIANCE PASSENGER FOOTBOARD KIT – BLACK ANODIZED

Notice: The prices appearing in this catalog are the manufacturer's suggested retail prices. Actual retail prices may vary.

CONTROLS 589

Hand & Foot Controls Collection



D. DEFIANCE FOOTPEGS – BLACK ANODIZED



D. DEFIANCE FOOTPEGS – BLACK ANODIZED
(50500678 SHOWN)



D. DEFIANCE FOOTPEGS – BLACK ANODIZED
(50500655 SHOWN)



D. DEFIANCE FOOTPEGS – BLACK ANODIZED
(50500808 SHOWN)



D. DEFIANCE FOOTPEGS – BLACK ANODIZED
(50500805 SHOWN)



D. DEFIANCE FOOTPEGS – BLACK ANODIZED
(50501010 SHOWN)



D. DEFIANCE FOOTPEGS – BLACK ANODIZED
(50500833 SHOWN)



E. DEFIANCE SHIFTER PEG – BLACK ANODIZED

D. DEFIANCE FOOTPEGS – BLACK ANODIZED

Topped with high-traction rubber, these custom aluminum footpegs feature a pattern of deep lateral grooves and a stylized H-D logo for a modern sleek look.

50500678 **\$129.95**

Fits models with H-D® male mount-style footpeg supports (except rider position on '17-later XG750A, '07-'10 XL883L, '07-later XL883N, XL1200N, XL1200V and XL1200X, '11-later XL1200C and XL1200T, '18-later XL1200NS and XL1200XS, '08-'13 XR and '08-'17 FXCW, FXCWC, FXS, FXSB, FXSE and FXSBSE models and the rider and passenger position on '18-later Softail® models).

50500655 With Removable Wear Peg. **\$129.95**

Fits '11-later XL883L and XL1200C, '12-'16 XL1200V, '10-later XL1200X, '18-later XL1200XS, '14-later XL models equipped with Extended Reach Forward Control Conversion Kit P/N 50700030, '08-'11 FXCW and FXCWC, '11-'17 FXS and FXSB, and '16-'17 FXSE models.

50500808 Rider Footpegs with Removable Wear Peg. **\$129.95**

Fits rider position on '18-later FXBR and FXBRS models.

50500805 Rider Footpegs. **\$129.95**

Fits rider position on '18-later FLSB, FXBB and FXLR models.

50501010 Rider Footpegs. **\$129.95**

Fits rider position on '18-later FXFB, FXFBS and '19-later FXDRS models.

50500833 Passenger Footpegs. **\$129.95**

Fits passenger position on '18-later Softail models.

E. DEFIANCE SHIFTER PEG – BLACK ANODIZED

Wrapped in perforated rubber, these easy-to-install shifter pegs protect your boot leather when shifting and add a clean contemporary look to your ride.

33600111 **\$39.95**

Fits all models (except '06-later VRSC™ models with forward controls and '08-'13 XR models).

Model Family Fitment:

- V-ROD
- SPORTSTER
- DYNA
- SOFTAIL
- TOURING

Notice: The prices appearing in this catalog are the manufacturer's suggested retail prices. Actual retail prices may vary.

590 CONTROLS

Hand & Foot Controls Collection

DEFIANCE COLLECTION - CHROME

Dare to be bold. Dressed in luxurious chrome, this complete hand and foot control assortment raises the customization bar. Defined by sweeping curves and accented with deep longitudinal lines and a contemporary H-D logo, the Defiance Collection features rich textured black rubber traction surfaces set in a field of mirror chrome.

A. DEFIANCE HAND GRIPS – CHROME

The comfortable 1.5" diameter grips are easy to install, and incorporate a glueless design that allows you to remove the grips for service without damage.

56100222 **\$89.95**
Fits '15-later XG models (except XG750A).

56100160 **\$129.95**
Fits '02-'17 VRSC™, '96-later XL, '08-'13 XR, '93-'17 Dyna® (except FXDLS), '95-'15 Softail® (except FLSTNSE, FLSTSE, FXSBSE and '11-'12 FLSTSE) and '96-'07 Touring models.

56100158 **\$129.95**
Fits '16-'17 Dyna FXDLS and '16-later Softail models, '14-'15 FLSTNSE, '11-'12 FLSTSE, '13-'14 FXSBSE, and '08-later Touring and Trike models.



A. DEFIANCE HAND GRIPS – CHROME

B. DEFIANCE BRAKE PEDAL PADS – CHROME

This stylish brake pedal pad features a rich black rubber panel set into the recessed surface, surrounded by deep accent grooves.

50600182 Small. **\$49.95**
Fits '15-later XG models (except XG750A), '14-later XL models with Extended Reach Forward Control Kit P/N 50700030, '93-'17 Dyna models with forward controls, and '84-'17 FX Softail models (except FXSTDSE).

50600248 Small. **\$49.95**
Fits '18-later FXBR, FXBRS and FLBS models. Also fits '18-later Softail models equipped with Billet Style Rear Brake Lever for Forward Controls P/N 41600218, 41600219 and 41600220.

50600179 Large. **\$64.95**
Fits '12-'16 FLD, '86-'17 FL Softail and '80-later Touring and Trike models.

50600257 Large. **\$59.95**
Fits '18-later FL Softail models equipped with rider footboards.

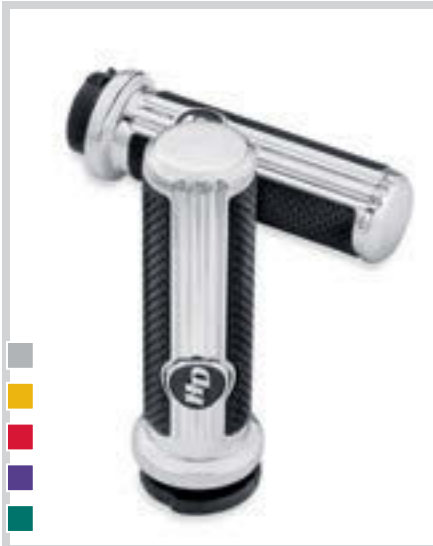

A. DEFIANCE HAND GRIPS – CHROME



B. DEFIANCE BRAKE PEDAL PADS – CHROME

C. DEFIANCE FOOTBOARD KIT – CHROME

These extended length sweeping shark-fin footboards are shaped to maintain a long and lean appearance while offering plenty of options for foot repositioning while riding. The aluminum footboards feature an elegant perforated rubber pad recessed into the surface, surrounded by deep grooves and a contemporary H-D logo. Kit includes left and right boards.

50500515 Rider. **\$399.95**
Fits '12-'16 FLD, '00-'17 FL Softail, '00-later Touring (except FLHTCUL and FLHTKL), and '09-'13 Trike models. Installation on '00-'17 Softail FLS, FLSS, FLSTFB, FLSTFBS and FLSTN models requires separate purchase of Jiffy Stand P/N 50087-07A. Not for use with Ergo Jiffy Stand P/N 50000091 or Jiffy Stand Extension Kit P/N 50233-00, 50000008 or 50000023.

50500797 Rider. **\$399.95**
Fits '18-later FL Softail models equipped with rider footboards.

50500516 Passenger. **\$299.95**
Fits '06-'17 Dyna, '00-later Softail (except FXDRS) and '86-later Touring models equipped with passenger footboard support. Does not fit Trike models.



C. DEFIANCE RIDER FOOTBOARD KIT – CHROME



C. DEFIANCE PASSENGER FOOTBOARD KIT – CHROME

Notice: The prices appearing in this catalog are the manufacturer's suggested retail prices. Actual retail prices may vary.



D. DEFIANCE FOOTPEGS – CHROME



**D. DEFIANCE FOOTPEGS – CHROME
(50500535 SHOWN)**



**D. DEFIANCE FOOTPEGS – CHROME
(50500533 SHOWN)**



**D. DEFIANCE FOOTPEGS – CHROME
(50500806 SHOWN)**



**D. DEFIANCE FOOTPEGS – CHROME
(50500803 SHOWN)**



**D. DEFIANCE FOOTPEGS – CHROME
(50501008 SHOWN)**



**D. DEFIANCE FOOTPEGS – CHROME
(50500831 SHOWN)**



E. DEFIANCE SHIFTER PEG – BLACK ANODIZED

D. DEFIANCE FOOTPEGS – CHROME

Topped with high-traction rubber, these custom aluminum footpegs feature a pattern of deep lateral grooves and a stylized H-D logo for a modern sleek look.

50500535 **\$129.95**

Fits models with H-D® male mount-style footpeg supports (except rider position on '17-later XG750A, '07-'10 XL883L, '07-later XL883N, XL1200N, XL1200V and XL1200X, '11-later XL1200C and XL1200T, '18-later XL1200NS and XL1200XS, '08-'13 XR and '08-'17 FXCW, FXCWC, FXS, FXSB, FXSE and FXSBSE models and the rider and passenger position on '18-later Softail® models).

50500533 With Removable Wear Peg. **\$129.95**

Fits '11-later XL883L and XL1200C, '12-'16 XL1200V, '10-later XL1200X, '18-later XL1200XS, '14-later XL models equipped with Extended Reach Forward Control Conversion Kit P/N 50700030, '08-'11 FXCW and FXCWC, '11-'17 FXS and FXSB, and '16-'17 FXSE models.

50500806 Rider Footpegs with Removable Wear Peg. **\$129.95**

Fits rider position on '18-later FXBR and FXBRS models.

50500803 Rider Footpegs. **\$129.95**

Fits rider position on '18-later FLSB, FXBB and FXLR models.

50501008 Rider Footpegs. **\$129.95**

Fits rider position on '18-later FXFB, FXFBS and '19-later FXDRS models.

50500831 Passenger Footpegs. **\$129.95**

Fits passenger position on '18-later Softail models.

E. DEFIANCE SHIFTER PEG – CHROME

Wrapped in perforated rubber, these easy-to-install shifter pegs protect your boot leather when shifting and add a clean contemporary look to your ride.

33600100 **\$39.95**

Fits all models (except '06-'17 VRSC™ models with forward controls and '08-'13 XR models).

Model Family Fitment:

- V-ROD
- SPORTSTER
- DYNA
- SOFTAIL
- TOURING

Notice: The prices appearing in this catalog are the manufacturer's suggested retail prices. Actual retail prices may vary.

592 CONTROLS

Hand & Foot Controls Collection

EDGE CUT COLLECTION

Live your life on the edge. The Edge Cut Collection features a crisp anodized finish that is machined to expose the highlights of raw aluminum. The contrasting cut back look makes a powerful visual statement and works great with both traditional and contemporary customizing styles.

A. EDGE CUT HAND GRIPS

The hand grips are a comfortable 1.5" diameter and the machined slots and narrow rubber bands offer plenty of traction, with or without gloves. Glueless design permits removal for servicing without damage.

56100083 **\$84.95**
Fits '15-later XG models (except XG750A).

57454-10 **\$99.95**
Fits '02-'17 VRSC™, '96-later XL, '08-'13 XR, '91-'17 Dyna® (except FXDLS), '96-'15 Softail® (except FLSTNSE, FXSBSE and '11-'12 FLSTSE) and '96-'07 Touring models.

57457-10 **\$99.95**
Fits '16-'17 Dyna FXDLS and '16-later Softail models, '14-'15 FLSTNSE, '11-'12 FLSTSE, '13-'14 FXSBSE and '08-later Touring (except '18-later FLTRXSE) and Trike models.

B. EDGE CUT BRAKE PEDAL PADS

Available in two sizes, the brake pedal pads feature deep surface grooves and narrow rubber bands for traction during application.

42847-10 Small. **\$44.95**
Fits '15-later XG models (except XG750A), '14-later XL models with Extended Reach Forward Control Kit P/N 50700030, '93-'17 Dyna models with forward controls, and '84-'17 FX Softail models (except FXSTDSE).

50600317 Small. **\$44.95**
Fits '18-later FXBR, FXBRS and FLSB models. Also fits '18-later Softail models equipped with Billet Style Rear Brake Lever for Forward Controls P/N 41600218, 41600219 and 41600220.

41449-10 Large. **\$49.95**
Fits '12-'16 FLD, '86-'17 FL Softail and '80-later Touring and Trike models.

50600318 Large. **\$49.95**
Fits '18-later FL Softail models equipped with rider footboards.

C. EDGE CUT FOOTBOARD INSERT KITS

Machined from billet aluminum, these footboard inserts retain the cast-in vibration isolation found on Original Equipment footboards. The over-molded rubber provides both comfort and traction while riding. Kit includes right and left insert.

54187-10 Rider – Traditional Shape. **\$199.95**
Fits models with traditional-shaped rider footboards. Does not fit '18-later Softail models.

50500729 Rider – Classic Style. **\$219.95**
Fits '18-later FL Softail models equipped with classic style rider footboards.

50500732 Rider – Contemporary Style. **\$219.95**
Fits '18-later FL Softail models equipped with contemporary style rider footboards.

54196-10 Passenger – Traditional Shape. **\$179.95**
Fits models equipped with traditional-shaped passenger footboards.



A. EDGE CUT HAND GRIPS



A. EDGE CUT HAND GRIPS



B. EDGE CUT BRAKE PEDAL PADS



C. EDGE CUT RIDER FOOTBOARD INSERTS – TRADITIONAL SHAPE (SHOWN WITH LARGE EDGE CUT BRAKE PEDAL PAD)



C. EDGE CUT RIDER FOOTBOARD INSERTS – RIDER CLASSIC STYLE



C. EDGE CUT RIDER FOOTBOARD INSERTS – RIDER CONTEMPORARY STYLE



C. EDGE CUT PASSENGER FOOTBOARD INSERTS – TRADITIONAL SHAPE

Notice: The prices appearing in this catalog are the manufacturer's suggested retail prices. Actual retail prices may vary.

CONTROLS 593

Hand & Foot Controls Collection



D. EDGE CUT RIDER FOOTPEGS



D. EDGE CUT FOOTPEGS
(49312-10 SHOWN)



D. EDGE CUT RIDER FOOTPEGS
(50500030 SHOWN)



D. EDGE CUT RIDER FOOTPEGS
(50500967 SHOWN)



D. EDGE CUT RIDER FOOTPEGS
(50500851 SHOWN)



D. EDGE CUT RIDER FOOTPEGS
(50501020 SHOWN)



D. EDGE CUT PASSENGER FOOTPEGS
(50500857 SHOWN)



E. EDGE CUT SHIFTER PEG

D. EDGE CUT FOOTPEGS

The slim footpeg design allows a comfortable pivot point and the wide surface and narrow rubber bands hold your boots firmly in place.

49312-10 Footpegs. **\$84.95**
Fits models with H-D® male mount-style footpeg supports (except the rider position on '17-later XG750A, '07-'10 XL883L, '07-later XL883N, XL1200N, XL1200T, XL1200V and XL1200X, '11-later XL1200C, '16-later XL1200CX, '18-later XL1200NS and XL1200XS, '08-'13 XR and '08-'17 FXCW, FXCWC, FXS, FXSB, FXSBSE, FXSE and the rider and passenger position on '18-later Softail® models).

50500030 Footpegs with Styled Wear Peg. **\$94.95**
Fits '11-later XL883L and XL1200C, '16-later XL1200CX, '12-'16 XL1200V, '10-later XL1200X, '18-later XL1200XS, '14-later XL models equipped with Extended Reach Forward Control Conversion Kit P/N 50700030, '08-'11 FXCW and FXCWC, '11-later FXS and FXSB, and '16-later FXSE models. Does not fit '15-later XG models.

50500967 Rider Footpegs with Removable Wear Peg. **\$99.95**
Fits rider position on '18-later FXBR and FXBRS models.

50500851 Rider Footpegs. **\$99.95**
Fits rider position on '18-later FL5B, FXBB and FXLR models.

50501020 Rider Footpegs. **\$99.95**
Fits rider position on '18-later FXFB, FXFBS and '19-later FXDRS models.

50500857 Passenger Footpegs. **\$99.95**
Fits passenger position on '18-later Softail models.

E. EDGE CUT SHIFTER PEG

Shifter pegs feature a slim design for easy access and narrow rubber bands that protect your boot toe from abrasion during shifting.

34671-10 **\$29.95**
Fits all models (except '06-'17 VRSC™ models with forward controls and '08-'13 XR).

Model Family Fitment:

- V-ROD
- SPORTSTER
- DYNA
- SOFTAIL
- TOURING

Notice: The prices appearing in this catalog are the manufacturer's suggested retail prices. Actual retail prices may vary.

594 CONTROLS

Hand & Foot Controls Collection

BRASS COLLECTION

The authentic alternative to the typical chrome-covered or blacked-out look, the Harley-Davidson® Brass Collection delivers a warm, hand-crafted look to your custom ride. These minimalistic living finish components make a garage-built styling statement and are the ideal addition to your stripped-down bobber or café motorcycle. Artistically manufactured from solid brass, these components feature a natural antique finish that will age and patina when exposed to the elements. Unlike bright polished and plated brass trim, these heritage-finished components are subtle additions to your ride and don't compete for attention with the rest of the bike. Brass Collection components are factory treated with wax to slow the aging process, and are shipped with cleaning and care instructions.

A. BRASS COLLECTION HAND GRIPS

These rich natural brass 1.5" diameter grips are easy to install, and feature a glueless design that allows you to remove the grips for service without damage.

56100133 Hand Grips. **\$149.95**
Fits '16-'17 Dyna® FXDLS and '16-later Softail® models, '11-'12 FLSTSE, '14-'15 FLSTNSE, '13-'14 FXSBSE, '16-'17 FXSE and '08-later Touring (except '18-later FLTRXSE) and Trike models.

56100134 Hand Grips. **\$149.95**
Fits '02-'17 VRSC™, '96-later XL, '08-'13 XR, '96-'17 Dyna (except FXDLS), '96-'15 Softail (except FLSTNSE, FXSBSE and '11-'12 FLSTSE) and '96-'07 Touring models.

56100138 Hand Grips. **\$109.95**
Fits '15-later XG models (except XG750A).

B. BRASS COLLECTION SHIFTER PEG

Shifter peg features a lateral ribbed design and a flared endcap to complement the Brass Collection footpegs.

33600093 Shifter Peg. **\$69.95**
Fits all models (except '06-'17 VRSC models with forward controls and '08-'13 XR models).

C. BRASS COLLECTION BRAKE PEDAL PAD

Cast from solid brass, this natural finish brake pedal features three ribs stretched across the block shaped surface.

50600169 Brake Pedal Pad – Small. **\$99.95**
Fits '15-later XG models, '14-later XL models with Extended Reach Forward Control Kit P/N 50700030, '93-'17 Dyna models with forward controls, and '84-'17 FX Softail models (except FXSTDSE). Also fits '18-later FXBR, FXBRS and FLSEB models and '18-later Softail models equipped with Billet Style Rear Brake Lever for Forward Controls P/N 41600218, 41600219 and 41600220.



A. BRASS COLLECTION HAND GRIPS



A. BRASS COLLECTION HAND GRIPS



B/C. BRASS COLLECTION SHIFTER PEG AND BRAKE PEDAL PAD

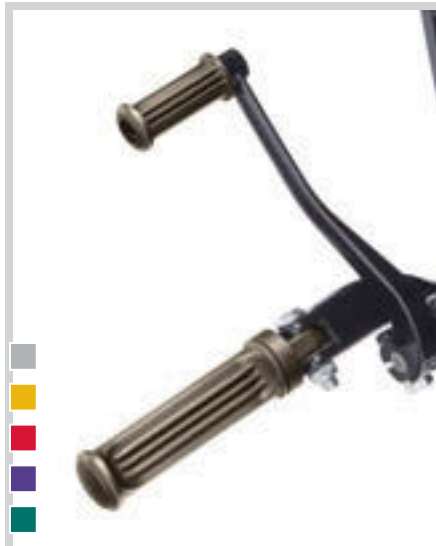

B. BRASS COLLECTION SHIFTER PEG



C. BRASS COLLECTION BRAKE PEDAL PAD

Notice: The prices appearing in this catalog are the manufacturer's suggested retail prices. Actual retail prices may vary.

CONTROLS 595

Hand & Foot Controls Collection



D. BRASS COLLECTION FOOTPEGS



D. BRASS COLLECTION FOOTPEGS – FORWARD CONTROL RIDER/HIGHWAY (50500988 SHOWN)



D. BRASS COLLECTION FOOTPEGS WITH STYLED WEAR PEG – FORWARD CONTROLS (50500482 SHOWN)



D. BRASS COLLECTION FOOTPEGS WITH STYLED WEAR PEG – MID CONTROLS (50500791 SHOWN)



D. BRASS COLLECTION FOOTPEGS – MID CONTROLS/PASSENGER (50500787 SHOWN)



D. BRASS COLLECTION FOOTPEGS – RIDER (50500690 SHOWN)



D. BRASS COLLECTION FOOTPEGS – RIDER (50500709 SHOWN)



D. BRASS COLLECTION FOOTPEGS – PASSENGER (50500781 SHOWN)

D. BRASS COLLECTION FOOTPEGS

Shaped for correct foot position on specific models, these heavyweight solid brass footpegs feature three raised ribs and a mushroom end to keep your boot in place.

50500988 Footpegs – Forward Control Rider/Highway. **\$159.95**

Fits models with forward control H-D® male mount-style footpeg supports (except the rider position on '15-later XG, '07-'10 XL883L, '07-later XL883N, XL1200N, XL1200T, XL1200V and XL1200X, '11-later XL1200C, '16-later XL1200CX, '17 XL1200CP and XL1200CA, '18-later XL1200NS and XL1200XS, '08-'13 XR and '08-'17 FXCW, FXCWC, FXS, FXSB, FXSBSE and FXSE and rider and passenger position on '18-later Softail® models).

50500482 Footpegs with Styled Wear Peg – Forward Controls. **\$159.95**

Fits '11-'18 XL1200C, '12-'16 XL1200V, '10-later XL1200X, '18-later XL1200XS, '14-later XL models with Extended Reach Forward Control Conversion Kit P/N 50700030, '08-'11 FXCW, FXCWC and '11-'17 FXS, FXSB, and '16-'17 FXSE.

50500791 Footpegs with Styled Wear Peg – Mid Controls. **\$159.95**

Fits '11-later XL883L and '16-later XL1200CX models.

50500787 Footpegs – Mid Controls/Passenger. **\$159.95**

Fits models with mid-control H-D male mount-style footpeg supports (except the rider position on '07-'10 XL883L, '07-later XL883N, XL1200N, XL1200T, XL1200V and XL1200X, '11-later XL1200C, '16-later XL1200CX '18-later XL1200NS and XL1200XS, and '08-'13 XR, '08-'17 FXCW, FXCWC, FXS, FXSB, FXSBSE and FXSE, and rider and passenger position on '18-later Softail models).

50500690 Rider Footpegs. **\$159.95**

Fits rider position on '18-later FXBR and FXBRS models.

50500709 Rider Footpegs. **\$159.95**

Fits rider position on '18-later FLSB, FXBB and FXLR models.

50500781 Passenger Footpegs. **\$159.95**

Fits passenger position on '18-later Softail models.

Model Family Fitment:

- V-ROD
- SPORTSTER
- DYNA
- SOFTAIL
- TOURING

Notice: The prices appearing in this catalog are the manufacturer's suggested retail prices. Actual retail prices may vary.

596 CONTROLS

Hand & Foot Controls Collection

WILLIE G SKULL COLLECTION

The deep black rubber pads are set against a brilliant polished and chrome-plated field to yield the dramatic appearance of the Skull Collection.

A. WILLIE G SKULL HAND GRIPS

Contrasting the chrome sinister skull logo surrounded by Harley-Davidson script, the raised rubber pads add positive grip and comfort for the long haul. Easy to install, these grips feature a glueless design that allows removal without damage.

Fits '02-'17 VRSC™, '96-later XL '08-'13 XR, '91-'17 Dyna® (except FXDLS), '96-'15 Softail® (except FLSTNSE, FXSBSE and '11-'12 FLSTSE) and '96-'07 Touring models.

56751-04	Small 1.3" Diameter.	\$99.95
56740-04	Medium 1.5" Diameter.	\$99.95
56741-04	Large 1.6" Diameter.	\$99.95

Fits '16-'17 Dyna FXDLS and '16-later Softail models, '14-'15 FLSTNSE, '11-'12 FLSTSE, '13-'14 FXSBSE and '08-later Touring (except '18-later FLTRXSE) and Trike models.

56740-08	Medium 1.5" Diameter.	\$99.95
-----------------	-----------------------	----------------

B. WILLIE G SKULL FOOTBOARD INSERTS

Easy-to-install footboard kits retain the Original Equipment cast-in vibration isolation for a fatigue-free ride. Kit includes left and right insert.

50704-04	Rider – Swept Wing Shape.	\$99.95
-----------------	---------------------------	----------------

Fits '12-'16 FLD and '86-'17 Softail, '86-later Touring and Trike models equipped with Swept Wing-Shaped rider footboards.

50710-04	Rider – Traditional Shape.	\$99.95
-----------------	----------------------------	----------------

Fits models with traditional-shaped rider footboards. Does not fit '18-later Softail models.

50500722	Rider – Classic Style.	\$99.95
-----------------	------------------------	----------------

Fits '18-later FL Softail models equipped with classic style rider footboards.

50500718	Rider – Contemporary Style.	\$99.95
-----------------	-----------------------------	----------------

Fits '18-later FL Softail models equipped with contemporary style rider footboards.

50713-04	Passenger – Traditional Shape.	\$89.95
-----------------	--------------------------------	----------------

Fits models equipped with traditional-shaped passenger footboards.



A. WILLIE G SKULL HAND GRIPS



A. WILLIE G SKULL HAND GRIPS



B. WILLIE G SKULL RIDER FOOTBOARD INSERTS – SWEEP WING SHAPE



B. WILLIE G SKULL RIDER FOOTBOARD INSERTS – TRADITIONAL SHAPE



B. WILLIE G SKULL RIDER FOOTBOARD INSERTS – CLASSIC STYLE



B. WILLIE G SKULL RIDER FOOTBOARD INSERTS – CONTEMPORARY STYLE



B. WILLIE G SKULL PASSENGER FOOTBOARD INSERTS – TRADITIONAL SHAPE

Notice: The prices appearing in this catalog are the manufacturer's suggested retail prices. Actual retail prices may vary.



C. WILLIE G SKULL FOOTPEGS



**C. WILLIE G SKULL FOOTPEGS
(50370-04 SHOWN)**



**C. WILLIE G SKULL RIDER FOOTPEGS
(50500856 SHOWN)**



**C. WILLIE G SKULL PASSENGER FOOTPEGS
(50500858 SHOWN)**



D. WILLIE G SKULL BRAKE PEDAL PADS



E. WILLIE G SKULL SHIFTER PEG

C. WILLIE G SKULL FOOTPEGS

Footpeg rotation is adjustable for position, so your feet ride on the rubber treads whether used as a rider, passenger or high-way peg. Kit includes left and right peg.

50370-04 **\$84.95**

Fits models with H-D® male mount-style footpeg supports (except the rider position on '15-later XG, '07-'10 XL883L, '07-later XL883N, XL1200N, XL1200T, XL1200V and XL1200X, '11-later XL1200C, '16-later XL1200CX, '17-later XL1200CP and XL1200CA, '18-later XL1200NS and XL1200XS, '08-'13 XR and '08-'17 FXCW, FXCWC, FXS, FXSB, FXSBSE and FXSE and the rider and passenger position on '18-later Softail® models).

50500856 Rider Footpegs. **\$84.95**
Fits '18-later FL5B, FXBB, FXBR, FXBRS, and FXLR models.

50500858 Passenger Footpegs. **\$84.95**
Fits passenger position on '18-later Softail models.

D. WILLIE G SKULL BRAKE PEDAL PADS

Available in two sizes to fit most Harley-Davidson® motorcycles, these easy-to-install brake pedal pads complement Willie G Collection pegs and footboard inserts for a complete look.

42710-04 Small. **\$59.95**

Fits '15-later XG models (except XG750A), '14-later XL models with Extended Reach Forward Control Kit P/N 50700030, '93-'17 Dyna® models with forward controls, and '84-'17 FX Softail models (except FXSTDSE).

50600313 Small. **\$59.95**

Fits '18-later FXBR, FXBRS and FL5B models. Also fits '18-later Softail models equipped with Billet Style Rear Brake Lever for Forward Controls P/N 41600218, 41600219 and 41600220.

42711-04 Large. **\$69.95**

Fits '12-'16 FLD, '86-'17 FL Softail and '80-later Touring and Trike models.

50600311 Large. **\$69.95**

Fits '18-later FL Softail models equipped with rider footboards.

E. WILLIE G SKULL SHIFTER PEG

This easy-to-install shifter peg can be rotated to a comfortable position and the smooth back protects the toe of your boot from wear while shifting.

34689-04 **\$29.95**

Fits all models (except '06-'17 VRSC™ models with forward controls and '08-'13 XR).

Model Family Fitment:

- V-ROD
- SPORTSTER
- DYNA
- SOFTAIL
- TOURING

Notice: The prices appearing in this catalog are the manufacturer's suggested retail prices. Actual retail prices may vary.

598 CONTROLS

Hand & Foot Controls Collection

AIRFLOW COLLECTION – CHROME

Defined by a brilliant chrome border and smooth rubber traction strips, this delta wing-inspired collection is the perfect match for your high-profile street machine. The rich black surfaces are divided by a deep mirror-finished groove that draws your eye from the leading to the trailing edge.

A. AIRFLOW HAND GRIPS – CHROME

Wrap your fingers around the chrome ridge for a sweet tactile feel. These grips combine a traction-grip crosshatch rubber surface with a comfortable 1.6" diameter for excellent control in wet or dry weather. The easy-to-install glueless design allows you to remove the grips for service without damage

56100112 \$99.95

Fits '02-'17 VRSC™, '96-later XL, '08-'13 XR, '96-'17 Dyna® (except FXDLS), '95-'15 Softail® (except FLSTNSE, FLSTSE and FXSBSE and '11-'12 FLSTSE) '96-'07 Touring models.

56100108 \$99.95

Fits '16-'17 Dyna FXDLS and '16-later Softail models, '14-'15 FLSTNSE, '11-'12 FLSTSE, '13-'14 FXSBSE, and '08-later Touring (except '18-later FLTRXSE) and Trike models.



A. AIRFLOW HAND GRIPS – CHROME

B. AIRFLOW FOOTPEGS – CHROME

These footpegs are adjustable for position and feature a rectangular shape and a raised rubber surface for foot support and traction whether used as a rider, passenger, or highway peg.

50500435 \$99.95

Fits models with H-D® male mount-style footpeg supports (except the rider position on '17-later XG750A, '07-'10 XL883L, '07-later XL883N, XL1200N, XL1200T, XL1200V and XL1200X, '11-later XL1200C, '16-later XL1200CX, '18-later XL1200NS and XL1200XS, '08-'13 XR and '08-'17 FXCW, FXCWC, FXS, FXSB, FXSBSE, FXSE and the rider and passenger position on '18-later Softail models).



B. AIRFLOW FOOTPEGS – CHROME (SHOWN WITH SMALL AIRFLOW BRAKE PEDAL PAD)



B. AIRFLOW FOOTPEG & SHIFTER PEG – CHROME

C. AIRFLOW SHIFTER PEG – CHROME

This simple-to-install Shifter Peg complements the sweeping design of the Airflow Collection footpegs and footboards. Rotation is adjustable for comfortable shifting, and the rubber back protects the top of your boot while downshifting.

33600075 \$29.95

Fits all models (except '06-'17 VRSC™ models with forward controls, '17-later XG750A and '08-'13 XR models).



C. AIRFLOW SHIFTER PEG – CHROME



D. AIRFLOW BRAKE PEDAL PAD – CHROME

D. AIRFLOW BRAKE PEDAL PAD – CHROME

The Airflow Brake Pedal Pad features curving chrome surrounding a deep black rubber pad, accented with a deep center groove. Easy-to-install, this brake pedal pad complements the Airflow Collection for a complete custom look.

50600165 Small \$44.95

Fits '15-later XG models (except XG750A), '14-later XL models with Extended Reach Forward Control Kit P/N 50700030, '93-'17 Dyna models with forward controls, and '84-'17 FX Softail models (except FXSTDSE).

50600159 Large \$59.95

Fits '12-'16 FLD, '86-'17 FL Softail, '80-later Touring and Trike models.

E. AIRFLOW FOOTBOARD KITS – CHROME

Comfortable and stylish, these fighter-wing shaped footboards add an elegant finish to your ride. The complete kit includes chrome delta wing-shaped footboard pans with vibration-isolated inserts for a fatigue-free ride. The black rubber pads feature a deep embossed Bar & Shield logo and rear-sweeping traction grooves.

50500436 Rider \$299.95

Fits '12-'16 FLD, '86-'17 FL Softail (except FLS, FLSS, FLSTFB, FLSTFBS and FXSE), '86-later Touring and '08-later Trike models.

50500437 Passenger \$219.95

Fits '06-'17 Dyna, '00-later Softail (except FXDRS) and '86-later Touring models equipped with passenger footboard supports. Does not fit Trike models.



E. AIRFLOW RIDER FOOTBOARD KIT – CHROME (SHOWN WITH LARGE AIRFLOW BRAKE PEDAL PAD)



E. AIRFLOW PASSENGER FOOTBOARD KIT – CHROME

Notice: The prices appearing in this catalog are the manufacturer's suggested retail prices. Actual retail prices may vary.

CONTROLS 599

Hand & Foot Controls Collection

CONTROLS



NEW

F. AIRFLOW HAND GRIPS – GLOSS BLACK



AIRFLOW COLLECTION – GLOSS BLACK

Defined by a sleek surround, the deep hockey-stick groove and the smooth rubber traction strips, this delta wing-inspired collection is the perfect match for your high-profile street machine. The rich black high-grip surfaces are divided by a deep channel that draws your eye from the leading to the trailing edge.

F. AIRFLOW HAND GRIPS – GLOSS BLACK

Wrap your fingers around the gloss black ridge for a sweet tactile feel. These grips combine a traction-grip crosshatch rubber surface with a comfortable 1.6" diameter for excellent control in wet or dry weather. The easy-to-install glueless design allows you to remove the grips for service without damage.

56100218 **\$99.95**
Fits '16-'17 Dyna® FXDLS and '16-later Softail® models, '14-'15 FLSTNSE, '11-'12 FLSTSE, '13-'14 FXSBSE, and '08-later Touring (except '18-later FLTRXSE) and Trike models.

56100356 **\$99.95**
Fits '02-'17 VRSC™, '96-later XL, '08-'13 XR, '96-'17 Dyna (except FXDLS), '95-'15 Softail (except FLSTNSE, FLSTSE and FXSBSE and '11-'12 FLSTSE) '96-'07 Touring models.

G. AIRFLOW FOOTPEGS – GLOSS BLACK

These footpegs are adjustable for position and feature a rectangular shape and a raised rubber surface for foot support and traction whether used as a rider, passenger, or highway peg.

50500717 **\$99.95**
Fits models with H-D® male mount-style footpeg supports (except the rider position on '17-later XG750A, '07-'10 XL883L, '07-later XL883N, XL1200N, XL1200V and XL1200X, '11-later XL1200C and XL1200T, '18-later XL1200NS and XL1200XS, '08-'13 XR, and '08-'17 FXCW, FXCWC, FXS, FXSB, FXSBSE and FXSE and the rider and passenger position on '18-later Softail models).

H. AIRFLOW SHIFTER PEG – GLOSS BLACK

This simple-to-install Shifter Peg complements the sweeping design of the Airflow Collection footpegs and footboards. Rotation is adjustable for comfortable shifting, and the rubber back protects the top of your boot while downshifting.

33600154 **\$29.95**
Fits all models (except '06-'17 VRSC models with forward controls, '17-later XG750A and '08-'13 XR).

I. AIRFLOW BRAKE PEDAL PAD – GLOSS BLACK

The Airflow Brake Pedal Pad features curving gloss black surrounding a deep black rubber pad, accented with a deep center groove. Easy-to-install, this brake pedal pad complements the Airflow Collection for a complete custom look.

50600232 Small. **\$44.95**
Fits '15-later XG models (except XG750A), '14-later XL models with Extended Reach Forward Control Kit P/N 50700030, '93-'17 Dyna models with forward controls, and '84-'17 FX Softail models (except FXSTDSE).

50600338 Large. **\$59.95**
Fits '12-'16 FLD, '86-'17 FL Softail and '80-later Touring and Trike models.

J. AIRFLOW FOOTBOARD KITS – GLOSS BLACK

Comfortable and stylish, these fighter-wing shaped footboards add an elegant finish to your ride. The complete kit includes gloss black delta wing-shaped footboard pans with vibration-isolated inserts for a fatigue-free ride. The black rubber pads feature a deep embossed Bar & Shield logo and rear-sweeping traction grooves.

50501265 Rider. **\$299.95**
Fits '12-'16 FLD, '86-'17 FL Softail (except FLS, FLSS, FLSTFB, FLSTFBS and FXSE), '86-later Touring and '08-later Trike models.

50501266 Passenger. **\$219.95**
Fits '06-'17 Dyna, '00-'17 Softail and '86-later Touring models equipped with passenger footboard supports. Does not fit Trike models.

Model Family Fitment:



Notice: The prices appearing in this catalog are the manufacturer's suggested retail prices. Actual retail prices may vary.



G. AIRFLOW FOOTPEGS – GLOSS BLACK (SHOWN WITH SMALL AIRFLOW BRAKE PEDAL PAD)



G. AIRFLOW FOOTPEG & SHIFTER PEG – GLOSS BLACK



H. AIRFLOW SHIFTER PEG – GLOSS BLACK



I. AIRFLOW BRAKE PEDAL PAD – GLOSS BLACK

NEW



J. AIRFLOW RIDER FOOTBOARD KIT – GLOSS BLACK (SHOWN WITH LARGE AIRFLOW BRAKE PEDAL PAD)

NEW



J. AIRFLOW PASSENGER FOOTBOARD KIT – GLOSS BLACK

NEW



600 CONTROLS

Hand & Foot Controls Collection

DIAMOND BLACK COLLECTION

Shroud your bike in mystery. This blacked-out hand and foot control collection features distinctive knurled surfaces that expose the raw billet aluminum for a dramatic contrast. Designed to age and “break-in” like a pair of comfortable stone-washed jeans, the satin black finish will complement both high-gloss and denim paint colors. The narrow rubber bands and the knurled surfaces provide a positive grip.

A. DIAMOND BLACK HAND GRIPS

Hand grips are a comfortable diameter and feature glueless installation that can be easily removed for service without damage.

56100142 **\$89.95**
Fits '15-later XG models (except XG750A).

56405-08 **\$99.95**
Fits '02-'17 VRSC™, '96-later XL '08-'13 XR, '91-'17 Dyna® (except FXDLS), '96-'15 Softail® (except FLSTNSE, FXSBSE and '11-'12 FLSTSE) and '96-'07 Touring models.

56746-08 **\$99.95**
Fits '16-'17 Dyna FXDLS and '16-later Softail models, '14-'15 FLSTNSE, '11-'12 FLSTSE, '13-'14 FXSBSE and '08-later Touring (except '18-later FLTRXSE) and Trike models.



A. DIAMOND BLACK HAND GRIPS

B. DIAMOND BLACK FOOTPEGS AND SHIFTER PEG

The slim footpeg design allows a comfortable pivot point and the wide surface and large diameter end cap keep your boot in place.

1. 50113-10 Footpegs – Large Diameter. **\$89.95**
Fits models with H-D® male mount-style footpeg supports (except the rider position on '15-later XG, '07-'10 XL883L, '07-later XL883N, XL1200N, XL1200T, XL1200V and XL1200X, '11-later XL1200C, '16-later XL1200CX, '17-later XL1200CP and XL1200CA, '18-later XL1200NS and XL1200XS, '08-'13 XR and '08-'17 FXCW, FXCWC, FXS, FXSB, FXSBSE, FXSE and the rider and passenger position on '18-later Softail models).

2. 50911-08A Footpegs – Small Diameter. **\$84.95**
Fits models with H-D male mount-style footpeg supports (except the rider position on '17-later XG750A, '07-'10 XL883L, '07-later XL883N, XL1200N, XL1200T, XL1200V and XL1200X, '11-later XL1200C, '16-later XL1200CX, '17-later XL1200CP and XL1200CA, '08-'13 XR and '08-'17 FXCW, FXCWC, FXS, FXSB, FXSBSE and FXSE and the rider and passenger position on '18-later Softail models).

3. 50695-08A Footpegs with Wear Peg. **\$89.95**
Fits '17-later XG750A, '07-'10 XL883L, '07-later XL883N, XL1200N, XL1200T and XL1200CA, '18-later XL1200NS and '08-'13 XR models.

4. 50500035 Footpegs with Styled Wear Peg. **\$89.95**
Fits '11-later XL883L and XL1200C, '16-later XL1200CX, '12-'16 XL1200V, '10-later XL1200X, '18-later XL1200XS, '14-later XL models equipped with Extended Reach Forward Control Conversion Kit P/N 50700030, '08-'11 FXCW and FXCWC, '11-'17 FXS and FXSB, and '16-'17 FXSE models.

5. 34690-08 Shifter Peg. **\$29.95**
Fits all models (except '06-'17 VRSC models with forward controls and '08-'13 XR).



B. DIAMOND BLACK FOOTPEGS AND SHIFTER PEG



C. DIAMOND BLACK BRAKE PEDAL PADS

C. DIAMOND BLACK BRAKE PEDAL PADS

Available in two sizes, these brake pedal pads complete the clean, custom black billet look.

41850-08 Small. **\$44.95**
Fits '15-later XG models (except XG750A), '14-later XL models with Extended Reach Forward Control Kit P/N 50700030, '93-'17 Dyna models with forward controls, and '84-'17 FX Softail models (except FXSTDSE).

46718-08 Large. **\$49.95**
Fits '12-'16 FLD, '86-'17 FL Softail and '80-later Touring and Trike models.

D. DIAMOND BLACK FOOTBOARD INSERT KIT

Machined from billet aluminum, these footboard inserts retain the cast-in vibration isolation found on the Original Equipment footboards. Kit includes right and left insert.

50549-08 Rider – Traditional Shape. **\$199.95**
Fits models with traditional-shaped rider footboards. Does not fit '18-later Softail models.

50627-08 Passenger – Traditional Shape. **\$179.95**
Fits models equipped with traditional-shaped passenger footboards.



D. DIAMOND BLACK RIDER FOOTBOARD INSERT KIT – TRADITIONAL SHAPE (SHOWN WITH BRAKE PEDAL PAD)



D. DIAMOND BLACK PASSENGER FOOTBOARD INSERT KIT – TRADITIONAL SHAPE

Model Family Fitment:

- V-ROD
- SPORTSTER
- DYNA
- SOFTAIL
- TOURING

CONTROLS 601

Hand & Foot Controls Collection



E. BURST HAND GRIPS

BURST COLLECTION

Split with tradition. The Burst Collection takes your ride in a new hard-edged direction. The combination of contrasting edges makes a powerful visual statement that complements both classic and contemporary customizing styles. The Burst Collection components create an impact all by themselves, but can also be seamlessly combined with Edge Cut and other gloss black accessories to complete the look.

E. BURST HAND GRIPS

The easy-to-install hand grips are a comfortable 1.6" diameter and feature a glueless design that can be removed for service without damage.

56100101A **\$139.95**
Fits '02-'17 VRSC™, '96-later XL '08-'13 XR, '91-'17 Dyna® (except FXDLS), '95-'15 Softail® (except FLSTNSE, FXSBSE and '11-'12 FLSTSE) and '96-'07 Touring models.

56100098A **\$139.95**
Fits '16-'17 Dyna FXDLS and '16-later Softail models, '14-'15 FLSTNSE, '11-'12 FLSTSE, '13-'14 FXSBSE and '08-later Touring (except '18-later FLTRXSE) and Trike models.

F. BURST FOOTPEGS

Round footpeg design allows a comfortable pivot point and the wide surface and large diameter end cap keep your boot in place. Rectangular footpeg rotation is adjustable for position, so your feet ride on the rubber treads whether used as a rider, passenger or highway peg.

33600059 Footpegs – Round. **\$109.95**
Fits models with H-D® male mount style footpeg supports (except the rider position on '17-later XG750A, '07-'10 XL883L, '07-later XL883N, XL1200N, XL1200V and XL1200X, '11-later XL1200C and XL1200T, '16-later XL1200CX, '08-'13 XR and '08-'17 FXCW, FXCWC, FXS, FXSB, FXSBSE, FXSE and the rider and passenger position on '18-later Softail models).

50500367 Footpegs – Rectangular. **\$159.95**
Fits models with H-D male mount style footpeg supports (except the rider position on '15-later XG, '07-'10 XL883L, '07-later XL883N, XL1200N, XL1200V and XL1200X, '11-later XL1200C and XL1200T, '16-later XL1200CX, '18-later XL1200NS and XL1200XS, '08-'13 XR and '08-'17 FXCW, FXCWC, FXS, FXSB, FXSBSE, FXSE and the rider and passenger position on '18-later Softail models).

50500441 Footpegs with Styled Wear Peg. **\$129.95**
Fits '11-later XL883L and XL1200C, '16-later XL1200CX, '12-'16 XL1200V, '10-later XL1200X, '18-later XL1200XS, '14-later XL models equipped with Extended Reach Forward Control Conversion Kit P/N 50700030, '08-'11 FXCW and FXCWC, '11-'17 FXS and FXSB, and '16-'17 FXSE models.

Shown with:

BURST SHIFTER PEG

These black anodized, machined shifter pegs add a unique, custom style. Easy to install and features rubber backing to protect the toe of your boot from scuffing.

33600032A **\$34.95**
Fits all models (except '06-'17 VRSC models with forward controls and '08-'13 XR).

G. BURST BRAKE PEDAL PAD

Styled to complement the distinctive black and satin aluminum look of the Burst Collection, this easy-to-install brake pedal pad completes the clean, custom billet look.

50600104A Large. **\$59.95**
Fits '12-'16 FLD, '86-'17 FL Softail and '80-later Touring and Trike models.

50600140 Small. **\$49.95**
Fits '15-later XG models (except XG750A), '14-later XL models with Extended Reach Forward Control Kit P/N 50700030, '93-'17 Dyna models with forward controls, and '84-'17 FX Softail models (except FXSTDSE).

H. BURST FOOTBOARD KITS

Long and lean, these half-shield shaped footboards add a unique, custom style to your ride. The kit includes black anodized footboard pans and vibration-isolated Burst Collection inserts.

50500244A Rider. **\$399.95**
Fits '12-'16 FLD and '86-'17 FL Softail (except FLS, FLSS, FLSTFB and FLSTFBS) and '86-later Touring and Trike models (except FLHTCUL and FLHTKL).

50500245A Passenger. **\$289.95**
Fits '06-'17 Dyna, '00-later Softail (except FXDRS) and '86-later Touring models equipped with passenger footboard supports. Does not fit Trike models.



F. BURST FOOTPEGS AND SHIFTER PEG



G. BURST BRAKE PEDAL PADS



H. BURST RIDER FOOTBOARD



H. BURST PASSENGER FOOTBOARD

Notice: The prices appearing in this catalog are the manufacturer's suggested retail prices. Actual retail prices may vary.

602 CONTROLS

Hand & Foot Controls Collection

CHROME AND RUBBER COLLECTION

Chrome and rubber both have their distinct places in the world of motorcycle styling. It seemed natural to bring the two together to create this unique collection.

A. CHROME AND RUBBER HAND GRIPS

Designed to match the Chrome and Rubber Footboard Inserts and Brake Pedal Pads, these grips are made from an injected rubber molding process that combines chromed steel and durable rubber.

Fits '02-'17 VRSC™, '96-later XL '08-'13 XR, '91-'17 Dyna® (except FXDLS), '96-'15 Softail® (except FLSTNSE, FXSBSE and '11-'12 FLSTSE) and '96-'07 Touring models.

56246-96A	Small.	\$89.95
56263-96A	Large.	\$89.95

Fits '16-'17 Dyna FXDLS and '16-later Softail models, '14-'15 FLSTNSE, '11-'12 FLSTSE, '13-'14 FXSBSE and '08-later Touring (except '18-later FLTRXSE) and Trike models.

56246-08	Small.	\$89.95
56263-08	Large.	\$89.95



A. CHROME AND RUBBER HAND GRIPS

B. CHROME AND RUBBER CUSTOM FOOTPEGS AND SHIFTER PEG

Fits models with H-D® male mount-style footpeg supports (except the rider position on FXCW, FXCWC, FXS, FXSB, FXSBSE and FXSE, '15-latter XG, '06-'17 Dyna, '03-later Sportster®, and '18-later Softail models.

50500-03	Oversize.	\$89.95
-----------------	-----------	----------------

Fits models in passenger and highway peg positions. Does not fit the rider and passenger position for '18-later Softail models.

50130-95A	Large.	\$84.95
50131-95A	Small.	\$84.95

Fits all models (except '06-'17 VRSC™ models with forward controls and '08-'13 XR).

34608-95	Shifter Peg.	\$29.95
-----------------	--------------	----------------



B. CHROME AND RUBBER CUSTOM FOOTPEGS AND SHIFTER PEG

C. CHROME AND RUBBER BRAKE PEDAL PADS

42478-95	Large.	\$49.95
-----------------	--------	----------------

Fits '12-'16 FLD, '86-'17 FL Softail and '80-later Touring and Trike models.

42476-95	Small.	\$44.95
-----------------	--------	----------------

Fits '15-later XG models (except XG750A), '14-later XL models with Extended Reach Forward Control Kit P/N 50700030, '93-'17 Dyna models with forward controls, and '84-'17 FX Softail models (except FXSTDSE).



C. CHROME AND RUBBER BRAKE PEDAL PADS

D. CHROME AND RUBBER FOOTBOARD INSERTS

50176-95	Rider – Traditional Shape.	\$109.95
-----------------	----------------------------	-----------------

Fits '12-'16 FLD and '86-'17 FL Softail, and '86-later Touring and Trike models equipped with traditional-shaped rider footboards.

50177-95	Passenger – Traditional Shape.	\$99.95
-----------------	--------------------------------	----------------

Fits models equipped with traditional-shaped passenger footboards.



D. CHROME AND RUBBER RIDER FOOTBOARD INSERTS – TRADITIONAL SHAPE (SHOWN WITH BRAKE PEDAL PAD)



D. CHROME AND RUBBER PASSENGER FOOTBOARD INSERTS – TRADITIONAL SHAPE

Notice: The prices appearing in this catalog are the manufacturer's suggested retail prices. Actual retail prices may vary.

CONTROLS 603

Hand & Foot Controls Collection



E. NOSTALGIC HAND GRIPS

NOSTALGIC COLLECTION

With a serious nod to the past, the Nostalgic Collection applies a fresh twist to a classic design. The chrome surround and raised rubber shapes outline the historic round shield and name band that has been at the center of Harley-Davidson® Original Equipment footboards for years. The classic look extends to the matching hand grips that feature the classic "bicycle grip" shape. This easy-to-install collection is the ideal match for your traditional styling direction.

E. NOSTALGIC HAND GRIPS

Comfortable hourglass style with a chrome accent ring and a molded-in Harley-Davidson logo. These rubber grips were inspired by Harley-Davidson® motorcycles of the 1940s.



56275-96B **\$69.95**
Fits '02-'17 VRSC™, '96-later XL, '08-'13 XR, '91-'17 Dyna® (except FXDLS), '96-'15 Softail® (except FLSTNSE, FXSBSE and '11-'12 FLSTSE) and '96-'07 Touring models.

56275-08 **\$69.95**
Fits '16-'17 Dyna FXDLS and '16-later Softail models, '14-'15 FLSTNSE, '11-'12 FLSTSE, '13-'14 FXSBSE and '08-later Touring (except '18-later FLTRXSE) and Trike models.

F. NOSTALGIC SHIFTER PEG

This easy-to-install shifter peg can be rotated to a comfortable position and the smooth back protects the toe of your boot from wear while shifting.

34627-99 **\$29.95**
Fits all models (except '06-'17 VRSC models with forward controls and '08-'13 XR).

G. NOSTALGIC BRAKE PEDAL PAD

These easy-to-install brake pedal pads complement the Nostalgic Collection pegs and footboard inserts for a complete look.

44248-96 **\$44.95**
Fits '12-'16 FLD, '86-'17 FL Softail and '80-later Touring and Trike models.

H. NOSTALGIC FOOTBOARD INSERT KITS

Quick, easy replacement of stock rubber footboard insert. Made from stamped chrome-plated steel and high-durability rubber. Retains cast-in vibration isolation found in stock footboard inserts. Kit includes left and right insert.

50187-96 Rider – Traditional Shape. **\$99.95**
Fits '12-'16 FLD and '86-'17 FL Softail, '86-later Touring and Trike models equipped with traditional-shaped rider footboards.

50190-96 Passenger – Traditional Shape. **\$89.95**
Fits models equipped with traditional-shaped passenger footboards.



F. NOSTALGIC SHIFTER PEG



G. NOSTALGIC BRAKE PEDAL PAD



H. NOSTALGIC RIDER FOOTBOARD INSERTS – TRADITIONAL SHAPE (SHOWN WITH BRAKE PEDAL PAD)



H. NOSTALGIC PASSENGER FOOTBOARD INSERTS – TRADITIONAL SHAPE

Model Family Fitment:

- V-ROD
- SPORTSTER
- DYNA
- SOFTAIL
- TOURING

Notice: The prices appearing in this catalog are the manufacturer's suggested retail prices. Actual retail prices may vary.

604 CONTROLS

Hand & Foot Controls Collection

STREAMLINER COLLECTION – HAND GRIPS

Inspired by the art-deco designs of the Streamliner era, this collection reflects the simple lines and shapes that still remain contemporary today. The rich black rubber features three raised chrome tri-line bands for contrast and a rich chrome surround to finish the look.

A. STREAMLINER HAND GRIPS

Complement the Streamliner look with these matching grips. The rich black rubber provides a positive grip while riding and the chrome tri-line design will provide just the right touch of chrome.

56100048 **\$99.95**

Fits '16-'17 Dyna® FXDLS and '16-later Softail® models, '14-'15 FLSTNSE, '11-'12 FLSTSE, '13-'14 FXSBSE and '08-later Touring (except '18-later FLTRXSE) and Trike models.



A. STREAMLINER HAND GRIPS

B. STREAMLINER FOOTPEG KIT

Complete the streamlined look with Streamliner Footpegs. Kit includes left and right footpegs.

50211-04 **\$159.95**

Fits rider positions on '03-earlier XL models with mid-controls and '05-earlier Dyna models with mid-controls. Fits all models in passenger and highway peg positions.

Shown with:

STREAMLINER SHIFTER PEG

Complement the streamlined footpegs and footboards with this simple-to-install Shifter Peg.

34967-04 **\$29.95**

Fits all models (except '06-'17 VRSC™ models with forward controls and '08-'13 XR models).

C. STREAMLINER BRAKE PEDAL PAD

Complement the streamlined footpegs and footboards with this simple-to-install Brake Pedal Pad. The chrome frame surrounds a black rubber pad accented with three polished bands for style and grip.

42712-04 Large **\$59.95**

Fits '12-'16 FLD, '86-'17 FL Softail and '80-later Touring and Trike models.



B. STREAMLINER FOOTPEGS AND SHIFTER PEG



C. STREAMLINER BRAKE PEDAL PAD

D. STREAMLINER RIDER FOOTBOARD KIT

Add the sleek sweeping footboard design from the Street Glide® model to your Touring bike. Kit includes vibration-isolation footboard pads with three polished bands, and the complete chrome-plated pans that easily bolt in place of the Original Equipment footboards.

50631-04 **\$229.95**

Fits '12-'16 FLD and '86-'17 FL Softail (except FLS, FLSS, FLSTFB and FLSTFBS), Touring and Trike models (except FLHTCUL and FLHTKL).

E. STREAMLINER PASSENGER FOOTBOARD INSERT KIT – SWEPT WING SHAPE

Styled to match the Street Glide model's Original Equipment Streamliner Rider Footboards. Featuring vibration-isolation rubber inserts with three polished bands, this insert is designed to fit the Swept Wing shape passenger footboard pan. Kit includes left and right side insert.

50420-05 **\$89.95**

Fits '06-'17 Dyna, '00-later Softail (except FXDRS) and '86-later Touring models equipped with Swept Wing-shaped passenger footboards. Does not fit Trike models. If installed on models equipped with Passenger Footboard Support kit P/N 50399-07A, footboards will not remain in flipped up position.



D. STREAMLINER RIDER FOOTBOARD KIT (SHOWN WITH BRAKE PEDAL PAD AND FOOTPEG KIT)



E. STREAMLINER PASSENGER FOOTBOARD INSERTS – SWEPT WING SHAPE

Model Family Fitment:

V-ROD
 SPORTSTER
 DYNA

 SOFTAIL
 TOURING

Notice: The prices appearing in this catalog are the manufacturer's suggested retail prices. Actual retail prices may vary.

CONTROLS 605

Hand & Foot Controls Collection

CONTROLS



F. CONTOURED CUSTOM HAND GRIPS

CRESTED BAR & SHIELD LOGO COLLECTION

Combine classic styling with contemporary shapes for a one-of-a-kind custom look. Styled to complement the Original Equipment rider footboard on the Softail® Deluxe model, the Crested Bar & Shield Logo Collection adds an "art deco" touch to any model. Rimmed with a smooth band of chrome, the contrasting vivid black rubber pad features a deep slotted design that runs parallel to the length of the motorcycle. Interrupted only by an embossed Bar & Shield logo, the molded rubber pad offers a comfortable and easy-to-clean surface.

F. CONTOURED CUSTOM HAND GRIPS

These grips combine a classic hourglass shape for comfort with the style for the new century. The black molded rubber surface with Bar & Shield logo gives plenty of grip, while the chrome end caps add a smooth organic touch.

Fits '02-'17 VRSC™, '96-later XL '08-'13 XR, '91-'17 Dyna® (except FXDLS), '96-'15 Softail® (except FLSTNSE, FXSBSE and '11-'12 FLSTSE) and '96-'07 Touring models.

56799-04 Small 1.3" Diameter. **\$89.95**
56459-01A Medium 1.5" Diameter. **\$89.95**

Fits '16-'17 Dyna FXDLS and '16-later Softail models, '14-'15 FLSTNSE, '11-'12 FLSTSE, '13-'14 FXSBSE and '08-later Touring (except '18-later FLTRXSE) and Trike models.

56459-08 Medium 1.5" Diameter. **\$89.95**

G. CRESTED BAR & SHIELD LOGO FOOTPEG KIT

50576-05 **\$84.95**

Fits models with H-D® male mount-style footpeg supports (except the rider position on '15-later XG, '07-'10 XL883L, '07-later XL883N, XL1200N, XL1200T, XL1200V and XL1200X, '11-later XL1200C, '16-later XL1200CX, '17-later XL1200CP and XL1200CA, '18-later XL1200NS and XL1200XS, '08-'13 XR and '08-'17 FXCW, FXCWC, FXS, FXSB, FXSBSE and FXSE and the rider and passenger position on '18-later Softail models).

Shown with:

CRESTED BAR & SHIELD LOGO SHIFTER PEG

33946-05 **\$29.95**

Fits all models (except '06-'17 VRSC models with forward controls and '08-'13 XR).

H. CRESTED BAR & SHIELD LOGO BRAKE PEDAL PADS

42700-05 Large. **\$49.95**

Fits '12-'16 FLD, '86-'17 FL Softail and '80-later Touring and Trike models.

42701-05 Small. **\$44.95**

Fits '15-later XG models (except XG750A), '14-later XL models with Extended Reach Forward Control Kit P/N 50700030, '93-'17 Dyna models with forward controls, and '84-'17 FX Softail models (except FXSTDSE).

I. TAPERED RIDER FOOTBOARD KIT WITH CRESTED BAR & SHIELD LOGO INSERT

Long and lean, the tapered design of these footboards allows maximum flexibility in foot placement for added comfort on long rides. Kit includes left and right tapered footboard pans and rubber isolated deluxe inserts with smooth chrome surround. The inserts feature a slotted rubber design with embossed Bar & Shield logo. Original Equipment on Softail Deluxe models.

50634-05 **\$149.95**

Fits '86-'17 FL Softail models.

J. TAPERED PASSENGER FOOTBOARD KIT WITH CRESTED BAR & SHIELD LOGO INSERT

Styled to match the rider footboards on the Softail Deluxe model, these Tapered Passenger Footboards feature a crested Bar & Shield logo rubber pad surrounded by a chrome accent. The footboard pan is chrome-plated throughout to add a custom touch, even in the folded position.

50396-05 **\$219.95**

Fits '06-'17 Dyna, '00-later Softail (except FXDRS) and '86-later Touring models equipped with passenger footboard supports. Does not fit Trike models.



G. CRESTED BAR & SHIELD LOGO FOOTPEGS AND SHIFTER PEG



H. CRESTED BAR & SHIELD LOGO BRAKE PEDAL PADS



I. TAPERED RIDER FOOTBOARD KIT WITH CRESTED BAR & SHIELD LOGO INSERT (SHOWN WITH BRAKE PEDAL PAD)



J. TAPERED PASSENGER FOOTBOARD KIT WITH CRESTED BAR & SHIELD LOGO INSERT

Notice: The prices appearing in this catalog are the manufacturer's suggested retail prices. Actual retail prices may vary.

606 CONTROLS

Hand Grips – Heated

HEATED HAND GRIPS

Keep comfortable on those cool mornings or frigid night rides. Warm hands have a major impact on overall body comfort and sometimes gloves just aren't enough. These thermostatically controlled grips feature variable heat settings controlled with a military grade resistor and use automatic temperature monitoring to adjust to ambient temperatures. With both hands on the grips, they will remain at a constant temperature regardless of changes in outside temperature. The self-contained control circuit and control knob means you have no additional switches or controller boxes to mount and the grips are switched on/off with the ignition to avoid draining your battery. The glueless grip design allows grip removal if you change handlebars or motorcycles.

A. AIRFLOW HEATED HAND GRIPS

Wrap your fingers around the ridge for a sweet tactile feel. These grips combine a traction-grip crosshatch rubber surface with a comfortable 1.6" diameter for excellent control in wet or dry weather. These grips have been thermally mapped to provide more uniform heat and are designed to achieve a maximum operating temperature approximately 20° Fahrenheit warmer than previous accessory heated grips for added warmth during cold rides. Gloss Black grip can be wired internally.

Fits '16-'17 Dyna® FXDLS, '16-later Softail®, and '08-later Touring and Trike models. Does not fit CVO™ models (except FXSE). '16-'17 Softail models require separate purchase of Electrical Connection Kit P/N 72673-11. '14-'16 Touring and Trike models require separate purchase of Electrical Connection Kit P/N 69200722. '18-later Softail and '17-later Touring and Trike models require Electrical Connection Kit P/N 69201599A. Fits '14-later models with internally wired handlebars when wired externally. See accessory handlebars for specific heated hand grip exclusions.

56100342	Gloss Black.	\$269.95
56100253	Chrome.	\$279.95

Fits '02-'17 VRSC™, '96-later XL, '08-'13 XR, '96-'17 Dyna (except FXDLS) and '96-'15 Softail (except FLSTSE, FLSTNSE, and FXSBSE) and '96-'07 Touring models. '14-later XL, '12-'17 Dyna and '11-'15 Softail models require separate purchase of Electrical Connection Kit P/N 72673-11. Fits '14-later models with internally wired bars (except FXDB models with Original Equipment handlebars) when wired externally. See accessory handlebars for specific heated hand grip exclusions.

56100358	Gloss Black.	\$269.95
56100256	Chrome.	\$269.95

B. KAHUNA™ COLLECTION HEATED HAND GRIPS

Understated but powerful. The Kahuna Collection Heated Hand Grips feature gloss black surfaces surrounded by rich, black rubber that provides grip and traction where needed, while providing warmth when the temperature drops. These grips are styled to complement other Kahuna Collection Accessories and feature a rich red Bar & Shield logo.

Fits '16-'17 Dyna FXDLS, '16-later Softail, and '08-later Touring and Trike models. Does not fit CVO models (except FXSE). '16-'17 Softail models require separate purchase of Electrical Connection Kit P/N 72673-11. '18-later Softail models require separate purchase of Electrical Connection Kit P/N 69201750. '14-'16 Touring and Trike models require separate purchase of Electrical Connection Kit P/N 69200722. '17-later Touring and Trike models require Electrical Connection Kit P/N 69201599A. '08-'09 models require separate purchase of Jumper Harness P/N 70415-08A, Connector P/N 72902-01BK, and Terminal Pin P/N 72990-01 (Qty 2). See instruction sheet for details. Fits '14-later models with internally wired handlebars. See accessory handlebars for specific heated hand grip exclusions.

56100318	Chrome.	\$269.95
56100331	Gloss Black.	\$269.95



A. AIRFLOW HEATED HAND GRIPS – GLOSS BLACK



A. AIRFLOW HEATED HAND GRIPS – CHROME



B. KAHUNA HEATED HAND GRIPS – GLOSS BLACK



B. KAHUNA HEATED HAND GRIPS – CHROME

Notice: The prices appearing in this catalog are the manufacturer's suggested retail prices. Actual retail prices may vary.

CONTROLS 607

Hand Grips – Heated



C. HEATED HAND GRIPS – STREAMLINER

C. HEATED HAND GRIPS – STREAMLINER

Complement the Streamliner look with these matching grips. The rich black rubber provides a positive grip while riding and the chrome tri-line design will provide just the right touch of chrome. These grips have been thermally mapped to provide more uniform heat and are designed to achieve a maximum operating temperature approximately 20° Fahrenheit warmer than previous accessory heated grips for added warmth during cold rides.

56100255 **\$279.95**

Fits '16-'17 Dyna® FXDLS, '16-later Softail®, and '08-later Touring and Trike models. Does not fit CVO™ models (except FXSE). '16-'17 Softail models require separate purchase of Electrical Connection Kit P/N 72673-11. '14-'16 Touring and Trike models require separate purchase of Electrical Connection Kit P/N 69200722. '18-later Softail and '17-later Touring and Trike models require Electrical Connection Kit P/N 69201599A. Fits '14-later models with internally wired handlebars when wired externally. See accessory handlebars for specific heated hand grip exclusions.



D. HEATED HAND GRIPS – BLACK RUBBER

D. HEATED HAND GRIPS – BLACK RUBBER

Original Equipment on the FLHTK Ultra Limited model, these Black Rubber Heated Grips feature smooth surfaces and a clean design that complements any styling direction.

56100034 **\$209.95**

Fits '16-'17 Dyna FXDLS, '16-later Softail, and '08-later Touring and Trike models. Does not fit CVO models (except FXSE). '16-'17 Softail models require separate purchase of Electrical Connection Kit P/N 72673-11. '18 Softail models require separate purchase of Electrical Connection Kit P/N 69201750. '14-'16 Touring and Trike models require separate purchase of Electrical Connection Kit P/N 69200722. '17-later Touring and Trike models require Electrical Connection Kit P/N 69201599A. '08-'09 models require separate purchase of Jumper Harness P/N 70415-08A, Connector P/N 72902-01BK, and Terminal Pin P/N 72990-01 (Qty 2). See instruction sheet for details. Fits '14-later models with internally wired Original Equipment handlebars.

E. HEATED HAND GRIPS – COLLECTIONS

Styled to complement Harley-Davidson® hand and foot control collections, these thermostatically controlled heated hand grips will keep you comfortable on a cool weather ride.

Fits '16-'17 Dyna FXDLS, '16-later Softail, and '08-later Touring and Trike models. Does not fit CVO models (except FXSE). '16-'17 Softail models require separate purchase of Electrical Connection Kit P/N 72673-11. '14-'16 Touring and Trike models require separate purchase of Electrical Connection Kit P/N 69200722. '18-later Softail and '17-later Touring and Trike models require Electrical Connection Kit P/N 69201599A. Fits '14-later models with internally wired handlebars when wired externally. See accessory handlebars for specific heated hand grip exclusions.

56100257 Contoured. **\$279.95**

56100260 Willie G Skull. **\$279.95**

56100267 Chrome and Rubber – Small. **\$279.95**

Fits '02-'17 VRSC™, '96-later XL, '08-'13 XR, '91-'17 Dyna (except FXDLS) and '96-'15 Softail (except FLSTSE, FLSTNSE, and FXSBSE) and '96-'07 Touring models. '14-later XL, '12-'17 Dyna and '11-'15 Softail models require separate purchase of Electrical Connection Kit P/N 72673-11. Fits '14-later models with internally wired bars (except FXDB models with Original Equipment handlebars) when wired externally. See accessory handlebars for specific heated hand grip exclusions.

56100268 Contoured. **\$279.95**

56100259 Willie G Skull. **\$279.95**

56100266 Chrome and Rubber – Small. **\$279.95**

56100264 Chrome and Rubber – Large. **\$279.95**

56100261 Nostalgic. **\$279.95**



E. CONTOURED HEATED HAND GRIPS



E. WILLIE G SKULL HEATED HAND GRIPS



E. CHROME AND RUBBER HEATED HAND GRIPS



E. NOSTALGIC HEATED HAND GRIPS

Model Family Fitment:

- V-ROD
- SPORTSTER
- DYNA
- SOFTAIL
- TOURING

Notice: The prices appearing in this catalog are the manufacturer's suggested retail prices. Actual retail prices may vary.

608 CONTROLS

Hand Grips

A. SMALL DIAMETER HAND GRIPS – BLACK RUBBER

Original Equipment on the FLHTKL, Ultra Limited Low models, these Small Diameter Black Rubber Grips feature smooth surfaces and a clean design that complements any styling direction.

56100355 **\$29.95**
Fits '08-later Touring and '09-later Trike models.

B. GET-A-GRIP™ HAND GRIPS

Dressed in tactified rubber for superior traction, these elegant hand grips provide a positive connection to the controls in wet or dry weather. The soft touch cross-hatched rubber surface feels good against both gloved and bare skin and the "thicker in the middle" profile forms a natural fit with your closed fist. Shaped for maximum comfort, Get-A-Grip™ hand grips are available in your choice of standard or magnum diameters to comfortably accommodate almost any size hand. And you don't need to sacrifice style for comfort. Designed to accent any customizing direction, the mirror chrome or gloss black finishes complement both traditional and contemporary looks. The easy-to-install glueless design allows you to remove the grips for service without damage.

Fits '02-'17 VRSC™, '96-later XL, '08-'13 XR, '91-'17 Dyna® (except FXDLS), '96-'15 Softail® (except FLSTNSE, FXSBSE and '11-'12 FLSTSE) and '96-'07 Touring models.

56100007 Chrome, Standard 1.5" Diameter. **\$89.95**

56100009 Chrome, Magnum 1.6" Diameter. **\$89.95**

56100008 Black, Standard 1.5" Diameter. **\$89.95**

56100010 Black, Magnum 1.6" Diameter. **\$89.95**

Fits '16-'17 Dyna FXDLS and '16-later Softail models, '14-'15 FLSTNSE, '11-'12 FLSTSE, '13-'14 FXSBSE, and '08-later Touring (except '18-later FLTRXSE) and Trike models.

56100015 Chrome, Magnum 1.6" Diameter. **\$89.95**

56100036 Black, Magnum 1.6" Diameter. **\$89.95**

C. NOSTALGIC HAND GRIPS

Comfortable hourglass style with a chrome accent ring and a molded-in Harley-Davidson logo. These rubber grips were inspired by Harley-Davidson® motorcycles of the 1940s.

56275-96B **\$69.95**

Fits '02-'17 VRSC, '96-later XL, '08-'13 XR, '91-'17 Dyna (except FXDLS), '96-'15 Softail (except FLSTNSE, FXSBSE and '11-'12 FLSTSE) and '96-'07 Touring models.

56275-08 **\$69.95**

Fits '16-later Dyna FXDLS and '16-later Softail models, '14-'15 FLSTNSE, '11-'12 FLSTSE, '13-'14 FXSBSE and '08-later Touring (except '18-later FLTRXSE) and Trike models.



A. SMALL DIAMETER HAND GRIPS



B. GET-A-GRIP HAND GRIPS – CHROME



B. GET-A-GRIP HAND GRIPS – BLACK



C. NOSTALGIC HAND GRIPS

Model Family Fitment:

- V-ROD
- SPORTSTER
- DYNA
- SOFTAIL
- TOURING

Notice: The prices appearing in this catalog are the manufacturer's suggested retail prices. Actual retail prices may vary.

CONTROLS 609

Footpegs



D. CUSTOM FOOTPEGS AND SHIFTER PEG



E. O-RING FOOTPEGS AND SHIFTER PEG

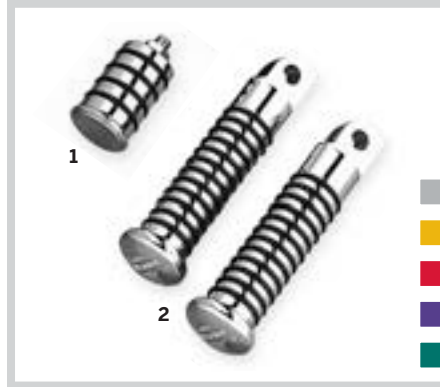

F. FOOTPEGS AND SHIFTER PEG WITH CHROME END COVER

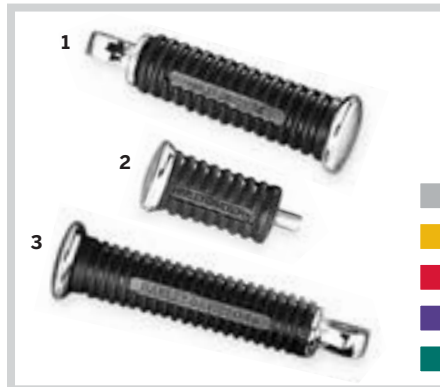

G. LARGE CUSHIONED FOOTPEG KIT



D. CUSTOM FOOTPEGS AND SHIFTER PEG

This footpeg grouping is chrome-plated and features a zinc die-cast body with steel shaft. The black rubber pads have Harley-Davidson graphics molded-in for rich detail. Allen® wrench included.

1. 50915-90T Footpegs – Large Diameter. **\$54.95**

Fits models with H-D® male mount-style footpeg supports (except the rider position on '15-later XG, '08-'17 FXCW, FXCWC, FXS, FXSB, FXSBSE and FXSE, '07-'10 XL883L, '07-later XL883N, XL1200N, XL1200T, XL1200V and XL1200X, '11-later XL1200C, '16-later XL1200CX, '17-later XL1200CP and XL1200CA, '18-later XL1200NS and XL1200XS, '08-'13 XR and the rider and passenger position on '18-later Softail® models).

2. 50916-90T Footpegs – Small Diameter. **\$49.95**

Fits models with H-D male mount-style footpeg supports (except the rider position on FXCW, FXCWC, FXS, FXSB, FXSBSE and FXSE, '15-later XG, '06-'17 Dyna®, '03-later Sportster®, '07-'10 XL883L, '07-later XL883N, XL1200N, XL1200T, XL1200V and XL1200X, '11-later XL1200C, '16-later XL1200CX, and '17-later XL1200CP and XL1200CA and the rider and passenger position on '18-later Softail models).

3. 34635-90T Custom Shifter Peg. **\$19.95**

Fits all models (except '06-'17 VRSC™ models with forward controls and '08-'13 XR).

E. O-RING FOOTPEGS AND SHIFTER PEG

1. 49149-84A Shifter Peg. **\$19.95**

Fits all models (except '06-later VRSC models with forward controls, '08-'13 XR models '06-'17 Dyna models with forward controls) or FXSE models.

2. 49128-82 Footpegs. **\$44.95**

Fits models with H-D male mount-style footpeg supports (except the rider position on FXCW, FXCWC, FXS, FXSB, FXSBSE and FXSE, '15-later XG, '06-'17 Dyna, '03-later Sportster, '07-'10 XL883L, '07-later XL883N, XL1200N, XL1200T, XL1200V and XL1200X, '11-later XL1200C, '16-later XL1200CX, and '17-later XL1200CP and XL1200CA and the rider and passenger position on '18-later Softail models).

F. FOOTPEGS AND SHIFTER PEG WITH CHROME END COVER

Footpegs feature cushioned rubber tread for sure-footed comfort and the chrome end cap adds a touch of style.

1. 49117-77TB Footpegs – Small Diameter. **\$39.95**

Fits models with H-D male mount-style footpeg supports (except the rider position on FXCW, FXCWC, FXS, FXSB, FXSBSE and FXSE, '15-later XG, '06-'17 Dyna, '03-later Sportster, '07-'10 XL883L, '07-later XL883N, XL1200N, XL1200T, XL1200V and XL1200X, '11-later XL1200C and '16-later XL1200CX, and '17-later XL1200CP and XL1200CA and the rider and passenger position on '18-later Softail models).

2. 34633-85T Shifter Peg. **\$14.95**

Fits all models (except '06-'17 VRSC models with forward controls and '08-'13 XR).

3. 49500-92T 5.0" Extended Footpegs. **\$44.95**

Fits models with H-D male mount-style footpeg supports (except the rider position on '07-'10 XL883L, '07-later XL883N, XL1200N, XL1200T, XL1200V and XL1200X, '11-later XL1200C, '16-later XL1200CX, '17-later XL1200CP and XL1200CA, '18-later XL1200NS and XL1200XS, '08-'13 XR and '08-'17 FXCW, FXCWC, FXS, FXSB, FXSBSE, FXSE and the rider and passenger position on '18-later Softail models).

G. LARGE CUSHIONED FOOTPEG KIT

Large diameter footpegs feature cushioned rubber tread for sure-footed comfort.

49110-98 **\$44.95**

Fits models with H-D male mount-style footpeg supports (except the rider position on '17-later XG750A, '07-'10 XL883L, '07-later XL883N, XL1200N, XL1200T, XL1200V and XL1200X, '11-later XL1200C, '16-later XL1200CX, '18-later XL1200NS and XL1200XS, '08-'13 XR and '08-'17 FXCW, FXCWC, FXS, FXSB, FXSBSE, FXSE and the rider and passenger position on '18-later Softail models).

Notice: The prices appearing in this catalog are the manufacturer's suggested retail prices. Actual retail prices may vary.

610 CONTROLS

Footboards

CUSTOM FOOTBOARDS

To add style to your ride, install custom footboard inserts that match the shape of your Original Equipment footboards. To radically change the look, select footboard pans in a new shape or finish and add coordinating inserts that highlight your custom direction.

A. SWEEP WING RIDER FOOTBOARD PANS – CHROME

Add a sleek tapered look to your footboard-equipped model. These chrome-plated Sweep Wing Pans are installed using the Original Equipment mounts and hardware. Add your choice of Sweep-Wing Shaped footboard inserts (sold separately).

Fits '12-'16 FLD and '86-'17 FL Softail® (except FLS, FLSS, FLSTFB and FLSTFBS), Touring (except FLHTCUL, FLHTKL and FLHTCUL TC) and Trike models.

50683-04	Right.	\$59.95
50688-04	Left.	\$59.95



A. SWEEP WING RIDER FOOTBOARD PANS – CHROME (SHOWN WITH STREAMLINER INSERT)



A. SWEEP WING RIDER FOOTBOARD PANS – CHROME

B. BLACK RIDER FOOTBOARD PANS

Complete the blacked-out transformation. Replace the Original Equipment chrome footboard pans with sinister gloss black. Kit includes both the right and left pan and is installed using the Original Equipment hardware and insert pad. Custom footboard inserts are sold separately.

Fits '12-'16 FLD and '86-'17 FL Softail (except FLS, FLSS, FLSTFB and FLSTFBS), Touring (except FLHTCUL, FLHTKL and FLHTCUL TC) and Trike models.

51322-08	Traditional Shape.	\$99.95
51060-08	Sweep Wing Shape.	\$99.95



B. BLACK RIDER FOOTBOARD PANS – TRADITIONAL SHAPE



B. BLACK RIDER FOOTBOARD PANS – SWEEP WING SHAPE

C. HALF-MOON RIDER FOOTBOARDS

Combine the style of the '40s with the comfort of today. The classic half moon-shaped rider footboards are available in polished stainless steel or gloss black finish to complement your styling direction. The traditional Harley-Davidson rubber insert features a vibration-isolation design for a long, comfortable ride. Kit includes left and right footboard pans and matching rubber inserts.

Fits '86-'17 FL Softail models.

51345-08	Polished Stainless Steel.	\$154.95
51400-08	Gloss Black.	\$154.95



C. HALF-MOON RIDER FOOTBOARDS – POLISHED STAINLESS STEEL



C. HALF-MOON RIDER FOOTBOARDS – GLOSS BLACK

D. PASSENGER FOOTBOARD PANS – CHROME

Replace the factory black painted passenger footboard with the custom look of smooth chrome. The kit includes left- and right-hand traditional D-shaped footboard pans, chrome-plated and ready to install with your Original Equipment hardware. Just add your choice of footboard insert for the finishing touch. Footboard supports sold separately.

50752-04 \$169.95
Fits '06-'17 Dyna®, '00-later Softail (except FXDRS) and '86-later Touring and Trike models equipped with passenger footboard supports.



D. PASSENGER FOOTBOARD PANS – CHROME



Model Family Fitment:

- V-ROD
- SPORTSTER
- DYNA
- SOFTAIL
- TOURING

Notice: The prices appearing in this catalog are the manufacturer's suggested retail prices. Actual retail prices may vary.



E. SWEEP WING PASSENGER FOOTBOARD PANS – GROOVED



E. SWEEP WING PASSENGER FOOTBOARD PANS – SMOOTH



F. HALF-MOON PASSENGER FOOTBOARD PANS – CHROME



F. HALF-MOON PASSENGER FOOTBOARD PANS – GLOSS BLACK



G. CONCHO PASSENGER FOOTBOARD COVERS



H. V-LOGO PASSENGER FOOTBOARD COVERS



I. ROAD KING CLASSIC PASSENGER FOOTBOARD COVERS



J. HARLEY-DAVIDSON SCRIPT PASSENGER FOOTBOARD COVERS

E. SWEEP WING PASSENGER FOOTBOARD PANS

These unique Swept Wing Passenger Footboard Pans complement the Swept Wing Rider Footboard shape and allow you to replace the Original Equipment passenger footpegs on certain models with footboards. When folded, the footboard displays a mirror chrome surface in your choice of smooth or ball-milled grooved design. Footboard inserts and footboard supports sold separately.

Fits '06-'17 Dyna®, '00-later Softail® (except FXDRS) and '86-later Touring models equipped with passenger footboard supports. Does not fit Trike models.

50357-04	Chrome – Grooved.	\$169.95
50716-04	Chrome – Smooth.	\$169.95

F. HALF-MOON PASSENGER FOOTBOARD PANS AND INSERTS

Styled to match the Half-Moon Rider Footboards, these classic passenger footboards add both style and comfort to your nostalgic ride. Available in mirror chrome or gloss black finish, the kit includes left and right footboard pan and vibration-isolation footboard inserts. Model-specific footboard mounts are sold separately.

Fits '06-'17 Dyna, '00-later Softail (except FXDRS) and '86-later Touring models equipped with passenger footboard supports. Does not fit Trike models.

50807-08	Chrome.	\$189.95
50810-08	Gloss Black.	\$189.95

G. CONCHO PASSENGER FOOTBOARD COVERS

Heritage Softail® Classic-inspired conchos make these covers look great whether footboards are up or down.

50193-96 **\$79.95**

Fits '06-'17 Dyna, '86-'17 FL Softail and '87-later Touring and Trike models equipped with traditional D-shaped aluminum passenger footboards.

H. V-LOGO PASSENGER FOOTBOARD COVERS

V-Logos are die-cast aluminum integrated with the cover, then chrome-plated for a desirable shine. Includes all mounting hardware.

50194-96 **\$69.95**

Fits '06-'17 Dyna, '86-'17 FL Softail and '87-later Touring and Trike models equipped with traditional D-shaped aluminum passenger footboards.

I. ROAD KING® CLASSIC PASSENGER FOOTBOARD COVERS

The latest in the family of Road King® Classic inspired accessories, this chrome-plated steel footboard cover features a chrome die-cast Road King Classic medallion with black accents and a stylish leather accent piece. Mounting hardware included.

50246-00 **\$79.95**

Fits '06-'17 Dyna, '86-'17 FL Softail and '87-later Touring and Trike models equipped with traditional D-shaped aluminum passenger footboards.

J. HARLEY-DAVIDSON SCRIPT PASSENGER FOOTBOARD COVERS

These easy-to-install chrome covers are formed to fit over the stock footboard pan to add a touch of style to the profile of your bike. The simple, clean design features a deep embossed Harley-Davidson script for a finishing touch. Kit includes mounting hardware.

50782-91 **\$69.95**

Fits '06-'17 Dyna, '86-'17 FL Softail and '87-later Touring and Trike models equipped with traditional D-shaped aluminum passenger footboards.

Notice: The prices appearing in this catalog are the manufacturer's suggested retail prices. Actual retail prices may vary.

612 CONTROLS

Footpegs

A. MINI FOOTBOARD KIT

This footboard kit can be installed in place of traditional footpegs and provides a little additional leg support and more options to move your legs around on a long ride. Mini Footboards mount to the standard H-D® style footpeg supports and can be used in many rider, passenger and highway peg applications. Sole-gripping rubber complements Original Equipment or accessory footboards and footpegs and adds vibration isolation and a rich appearance.

Fits rider position:

'02-'17 VRSC™ models with forward controls (except VRSCDX and VRSCF), '15-later XG models (except XG750A), '06-earlier XL, '07-'10 XL883, XL883R, XL883C, XL1200C and XL1200R and '07-'11 XL1200L, '91-'17 Dyna® (except FLD) and '84-'17 Softail® models with forward controls (except FXCW, FXCWC, FXS, FXSB or FXSBSE).

Fits passenger position:

All models with H-D male-mount passenger peg mounts (except '06-earlier VRSC, '03-earlier XL, '05-earlier Dyna and Softail models equipped with Shotgun exhaust). '84-'17 Softail models require separate purchase of Support Kit P/N 50454-09. Does not fit passenger position on '18-later Softail models.

Fits highway peg position:

All models with frame-mount or engine guard-mount highway pegs (except Whiskers Adjustable Highway Bar P/N 50855-09 and 50865-09).

50500139	Small 3.0" – Chrome.	\$129.95
50500144	Small 3.0" – Gloss Black.	\$129.95
50500109	Large 4.0" – Chrome.	\$129.95
50500124	Large 4.0" – Gloss Black.	\$129.95

B. ENGINE GUARD MOUNT FOOTPEGS*

Custom engine guard mounted footpegs let you stretch your legs in style. Easy to install chrome-plated pegs clamp firmly to the guard. Sold in pairs.

Fits highway peg position on 1.0" and 1.25" engine guards (except VRSC).

49102-86T	Harley Script.	\$39.95
49144-86	Rubber Inserts.	\$39.95



A. MINI FOOTBOARD KIT – LARGE CHROME



A. MINI FOOTBOARD KIT – LARGE GLOSS BLACK



A. MINI FOOTBOARD KIT



B. ENGINE GUARD MOUNT FOOTPEGS – HARLEY SCRIPT



B. ENGINE GUARD MOUNT FOOTPEGS – RUBBER INSERTS



***WARNING:** Do not use engine guard footpegs under normal stop and go operating conditions. Doing so could result in death or serious injury.

Notice: The prices appearing in this catalog are the manufacturer's suggested retail prices. Actual retail prices may vary.

CONTROLS 613

Footpegs



C. BULLET TIP FOOTPEG BOLT KIT – CHROME



C. BULLET TIP FOOTPEG BOLT KIT – CHROME

Put the final touch on a custom footpeg installation with this chrome Bullet Tip Footpeg Bolt Kit. Sold in pairs, this accessory includes chrome button head bolts, washers and uniquely styled nuts. All hardware is developed to Original Equipment standards to ensure product quality.

94133-01 **\$24.95**
Fits male mount-style footpegs (except '08-'13 XR models).

D. FOOTPEG MOUNTING HARDWARE KIT – CHROME

Polished and chrome-plated hex head bolts replace the Original Equipment footpeg mounting hardware for a truly finished look. Kit includes two chrome-plated bolts and lock nuts with nylon inserts. The bolts carry a Harley-Davidson Bar & Shield proof mark. All hardware is developed to Original Equipment standards to ensure product quality.

94139-01 **\$14.95**
Fits male mount-style footpegs (except FLSTSE and '08-'13 XR models).

E. FOOTPEG MOUNTING PINS – POLISHED

Stainless steel for rust and corrosion resistance. Polished for good looks. Replaces Original Equipment footpeg mounting hardware.

42679-01 **\$12.95**
Fits male mount-style footpegs (except '08-'13 XR models).



D. FOOTPEG MOUNTING HARDWARE KIT – CHROME



E. FOOTPEG MOUNTING PINS – POLISHED

F. ADJUSTABLE PASSENGER FOOTPEG MOUNT KIT

Maximize your passenger's riding comfort. Proper foot position reduces the cramped or stretched-out feeling and relieves pressure on the knees and the tailbone. These Adjustable Mounts raise and lower the passenger footpeg to accommodate taller and shorter passengers. Easy to adjust with common tools, the mount adjusts through a 360° range (depending on model), allowing both fore and aft and up and down height adjustment. Kit includes left and right adjustable support assembly and all required mounting hardware. Footpegs sold separately.

50763-09 **\$149.95**
Fits models with H-D® male mount-style passenger footpeg supports (except Softail®). Does not fit with Heel Raiser Footpeg Kit P/N 50178-09. Does not fit the rider position.



F. ADJUSTABLE PASSENGER FOOTPEG MOUNT KIT



Model Family Fitment:

- V-ROD
- SPORTSTER
- DYNA
- SOFTAIL
- TOURING

Notice: The prices appearing in this catalog are the manufacturer's suggested retail prices. Actual retail prices may vary.

614 CONTROLS

Highway Pegs

A. BILLET ENGINE GUARD FOOTPEG MOUNTING KIT*

Here's a stylish way to get your feet into the wind. This beautifully polished Billet Aluminum Footpeg Mount Kit installs easily on your engine guard and lets you stretch your legs on cross-country rides. Available in your choice of chrome or gloss black finishes. Works with all H-D® style male-mount footpegs.

Fits front engine guards with 1.25" diameter tubing (except VRSC™ Engine Guard P/N 49267-01A, 49388-09, XL Engine Guard P/N 49060-04, 49287-11, 49215-07 or Softail® Nostalgic Engine Guard P/N 49037-05A). Does not fit with Chopped Engine Guards. Requires separate purchase of Chrome Bullet Tip Footpeg Bolt Kit P/N 94133-01.

50957-02B	Chrome.	\$99.95
54234-10	Gloss Black.	\$99.95

B. ADJUSTABLE HIGHWAY PEG MOUNTING KIT – ANGLED*

Stretch out for added comfort. This Adjustable Highway Peg Mounting Kit can be set for shorter riders and it can be reversed to reach far forward for those with long legs. The angled design allows the arm to reach back and around to clear fairing lowers. The arm can be raised and lowered for a custom fit. The mounting clamp firmly grips the engine guard and the locking design secures the peg at the desired angle. Available in mirror chrome or gloss black finishes, the complete kit includes matching mounting hardware. Footpegs sold separately.

Fits 1.25" engine guards. Does not fit with Chopped Engine Guards.

50829-07A	5.0" Long Angled – Chrome.	\$119.95
50830-07A	2.5" Short Angled – Chrome.	\$119.95
50500167	5.0" Long Angled – Gloss Black.	\$119.95
50500168	2.5" Short Angled – Gloss Black.	\$119.95



A. BILLET ENGINE GUARD FOOTPEG MOUNTING KIT – CHROME



A. BILLET ENGINE GUARD FOOTPEG MOUNTING KIT – GLOSS BLACK



B. ADJUSTABLE HIGHWAY PEG MOUNTING KIT – LONG ANGLED – CHROME



B. ADJUSTABLE HIGHWAY PEG MOUNTING KIT – SHORT ANGLED – CHROME



B. ADJUSTABLE HIGHWAY PEG MOUNTING KIT – LONG ANGLED – GLOSS BLACK



B. ADJUSTABLE HIGHWAY PEG MOUNTING KIT – SHORT ANGLED – GLOSS BLACK



***WARNING:** Do not use engine guard footpegs under normal stop and go operating conditions. Doing so could result in death or serious injury.



***WARNING:** Do not use highway pegs under normal stop and go operating conditions. Doing so could result in death or serious injury.

Model Family Fitment:

- V-ROD
- SPORTSTER
- DYNA
- SOFTAIL
- TOURING

Notice: The prices appearing in this catalog are the manufacturer's suggested retail prices. Actual retail prices may vary.

CONTROLS 615

Highway Pegs



C. ADJUSTABLE HIGHWAY PEG MOUNTING KIT – LONG OFFSET



C. ADJUSTABLE HIGHWAY PEG MOUNTING KIT – SHORT OFFSET

C. ADJUSTABLE HIGHWAY PEG MOUNTING KIT – OFFSET*

Take rider comfort to the next level. These Offset Adjustable Highway Peg Mounts allow the rider a wide range of adjustment to accommodate nearly every shape and size. The offset design allows installation on the side or top of the engine guard and the 360° rotation permits comfortable positioning for short or tall riders. The clamp securely grips the engine guard and the locking design keeps the peg at the desired angle. Kit includes chrome-plated clamp, adjustable arm and chrome mounting hardware. Footpegs are sold separately.

Fits 1.25" engine guards. Does not fit with Chopped Engine Guards.

50827-07A	4.5" Long Offset	\$139.95
50828-07A	3.0" Short Offset.	\$139.95

D. ADJUSTABLE HIGHWAY PEG MOUNTING KIT – 360°*

Change your foot position for added comfort on long stretches of open road. The 360° Adjustable Highway Peg can be rotated and locked in a wide range of positions to accommodate both the tall and short rider. The chrome-plated clamp holds its place on the engine guard and the arm locks the peg securely in position. Kit includes chrome-plated mount, arm and installation hardware. Footpegs sold separately.

50832-07A	3.0" Short Offset.	\$119.95
------------------	--------------------	-----------------

Fits 1.25" engine guards. Does not fit with Chopped Engine Guards.



D. ADJUSTABLE HIGHWAY PEG MOUNTING KIT – 360°



E. ENGINE GUARD FOOTPEG MOUNTING KIT

E. ENGINE GUARD FOOTPEG MOUNTING KIT*

Allows easy installation of any H-D® male mount-style footpegs on to H-D front engine guards. All pieces necessary are included in the kit, with no extra hardware to buy.

50964-98		\$44.95
-----------------	--	----------------

Fits 1.25" engine guards (except VRSC™ Guard P/N 49267-01A, 49388-09, XL Engine Guard P/N 49060-04 or 49215-07 or Softail® Nostalgic Engine Guard P/N 49037-05A). Does not fit with Chopped Engine Guards.

F. FOOTPEG THREE-PIECE CHROME CLAMP*

For use on frame or engine guard. Universal mount except VRSC models.

50903-85T		\$14.95
------------------	--	----------------

Fits 1.25" engine guards (except VRSC Engine Guard P/N 49267-01A, 49388-09, XL Engine Guard P/N 49060-04 or 49215-07 or Softail® Nostalgic Engine Guard P/N 49037-05A). Does not fit with Chopped Engine Guards.

G. ENGINE GUARD FOOTPEG MOUNT CHROME HARDWARE KIT*

Jump from zinc to chrome with this chrome-plated hardware kit, which replaces the standard hardware in Engine Guard Footpeg Mounting Kit P/N 50964-98. Made to Original Equipment standards for unmatched quality, the bolts bear the Harley-Davidson mark to signify they're the genuine article.

94140-02		\$19.95
-----------------	--	----------------

Fits Engine Guard Footpeg Mounting Kit P/N 50964-98.



F. FOOTPEG THREE-PIECE CHROME CLAMP



G. ENGINE GUARD FOOTPEG MOUNT CHROME HARDWARE KIT



***WARNING:** Do not use engine guard footpegs under normal stop and go operating conditions. Doing so could result in death or serious injury.



***WARNING:** Do not use highway pegs under normal stop and go operating conditions. Doing so could result in death or serious injury.

Notice: The prices appearing in this catalog are the manufacturer's suggested retail prices. Actual retail prices may vary.

616 CONTROLS

Mirrors

A. TAPERED FAIRING MOUNT MIRRORS*

Reflect your personal style. These slim forged aluminum Fairing Mount Mirrors minimize the profile at the edges of the Batwing Fairing for a clean custom look. The single-stalk mount permits a wide range of adjustability and the convex mirror face maximizes the field of view. The mirrors are designed as a direct replacement for the Street Glide® model's Original Equipment mirrors, and can be installed on other Batwing fairing-equipped models in place of handlebar-mounted mirrors. Tapered Fairing Mirrors are available in your choice of polished chrome or gloss black Edge Cut finish to match your styling direction.

Fits '14-later Electra Glide®, Street Glide®, Ultra Limited and Tri Glide® models.

56000098A Chrome.	\$229.95
56000099A Edge Cut.	\$229.95



A. TAPERED FAIRING MOUNT MIRRORS – CHROME

B. FAIRING MOUNT MIRRORS – BLACK*

Fairing Mount Mirrors offer a truly innovative look from the traditional handlebar-mounted mirrors. Mounting just inside the inner fairing, the molded plastic mirror housings complement the contours of the batwing fairing. They provide a wide range of adjustability and feature convex mirror glass that maximizes your field of view. The Bar & Shield logo is carefully laser-etched on each mirror glass. Kit includes necessary hardware, instructions and mounting template for easy installation.

56000076	\$99.95
Fits '14-later Electra Glide, Ultra Limited and Tri Glide models. Original Equipment on Street Glide models (except FLHTCUTC).	

91945-98B	\$99.95
Fits '96-'13 Electra Glide and Trike models. Original equipment on Street Glide models.	



A. TAPERED FAIRING MOUNT MIRRORS – EDGE CUT

C. FAIRING MOUNT MIRRORS – CHROME*

Add a splash of chrome to the batwing inner fairing. These Fairing Mount Mirrors de-clutter the handlebar and add a contemporary aero style to your ride. The attractive chrome housing provides a custom look and the convex mirror and wide range of adjustment maximizes your field of view. A direct bolt-on replacement for Original Equipment fairing mount mirrors, the kit includes the hardware and mounting template required for easy and accurate installation.

56000077	\$134.95
Fits '14-later Electra Glide, Street Glide, Ultra Limited and Tri Glide models (except FLHTCUTC).	

56000029	\$134.95
Fits '96-'13 Electra Glide, Street Glide and Trike models. Original Equipment on '12 FLHXSE models.	



B. FAIRING MOUNT MIRRORS – BLACK



C. FAIRING MOUNT MIRRORS – CHROME

*Harley-Davidson Motor Company cannot test and make specific fitment recommendations concerning every possible mirror and handlebar combination. Therefore, after installing new mirrors or handlebars and before operating the motorcycle, check to ensure that the mirrors provide the operator a clear view to the rear.

Notice: The prices appearing in this catalog are the manufacturer's suggested retail prices. Actual retail prices may vary.



D. WINDSHIELD TRIM MIRROR MOUNTING KIT – (SHOWN WITH TAPERED WINDSHIELD TRIM MIRRORS)

D. WINDSHIELD TRIM MIRROR MOUNTING KIT*

Put your best look front and center. This Windshield Trim Mirror Mounting Kit adds a finishing touch to the base of the windshield and positions the rear view mirrors (sold separately) at the fairing's upper edge. The sweeping arms place the mirror shell in a high-mount location, and permit a wide range of up-down-fore-aft adjustability. You get a clean looking handlebar or inner fairing, and a great rear view past your shoulders. Kit includes 3-piece trim and all required mounting hardware. Mirrors sold separately.

57400254 **\$149.95**

Fits '14-later Electra Glide®, Street Glide®, Ultra Limited and Tri Glide® models. FLHX, FLHXS and FLHXSE models equipped with fairing mounted mirrors require separate purchase of Fairing Plug Kit P/N 57300063.



E. WINDSHIELD TRIM MIRRORS – TAPERED (SHOWN WITH WINDSHIELD TRIM MIRROR MOUNTING KIT)

E. WINDSHIELD TRIM MIRRORS – TAPERED*

These Tapered Mirrors are a stylish addition to the Windshield Trim Mirror Mounting Kit P/N 57400254. The mirror provides a large reflective face for a great view to the rear, while the sculpted teardrop-shaped shell is styled to minimize the visual profile. Designed for easy installation and a wide range of adjustability, this kit includes left and right-hand mirror heads.

56000091 **\$149.95**

Fits models equipped with Windshield Trim Mirror Mounting Kit 57400254.

F. ILLUMINATED FAIRING MOUNT MIRROR COVERS – CHROME

Add auxiliary LED turn signals and a splash of chrome to the inner fairing. The perfect finishing touch to a fully dressed inner fairing, these chrome-plated mirror housings feature fast-acting amber LED turn signals at the outer edge. Side turn signals attract attention from the drivers around you and the plug-in, no-splice design simplifies installation.

56000084 **\$139.95**

Fits '14-later Touring and Trike models with fairing-mount mirrors. Does not fit with Split Vision Fairing Mount Mirrors P/N 92085-10 or Tapered Fairing Mount Mirrors P/N 56000098A or 56000099A.

92600-10 **\$139.95**

Fits '06-'13 FLHX and FLHXSE, Electra Glide and '10-'11 FLHXXX models equipped with Fairing Mount Mirrors P/N 91945-98B. Does not fit with Split Vision Fairing Mount Mirrors P/N 92085-10.



E. WINDSHIELD TRIM MIRRORS – TAPERED (SHOWN WITH WINDSHIELD TRIM MIRROR MOUNTING KIT)



F. ILLUMINATED FAIRING MOUNT MIRROR COVERS – CHROME

*Harley-Davidson Motor Company cannot test and make specific fitment recommendations concerning every possible mirror and handlebar combination. Therefore, after installing new mirrors or handlebars and before operating the motorcycle, check to ensure that the mirrors provide the operator a clear view to the rear.

Model Family Fitment:

- V-ROD
- SPORTSTER
- DYNA
- SOFTAIL
- TOURING

Notice: The prices appearing in this catalog are the manufacturer's suggested retail prices. Actual retail prices may vary.

618 CONTROLS

Mirrors

A. ROUND BAR END MIRROR – SATIN BLACK*

Complete the cut-down Café bike look. These Bar End Mirrors provide a clean, streamlined look when compared to traditional mirrors. These round convex mirrors plug into the end of the handlebar to extend beyond the hand grip for an improved field of view on the bike equipped with narrow bars. When equipped with the Bar End Mirror Hand Grips (sold separately), the mirrors are simply inserted into the end of the grip and tightened in place. The mirrors are adjustable for maximum rear visibility, and can be positioned above the bar or, in some configurations, below the bar. When positioned below the bar, the left hand mirror is used on the right, and the right hand mirror moves to the left side. Includes hardware required to fit both 7/8" or 1" bars. Right and left mirrors are sold separately.

Fits stock or accessory handlebars on '15-later XG (except models equipped with Drag Bar P/N 55800225 or 55800238), '96-later VRSC™ (except VRSCF), XL, XR, Dyna® (except FXDLS), '96-'15 Softail® (except FLSTNSE, FXSBSE and '11-'12 FLSTSE) and '96-'07 Touring models. Installation requires separate purchase of Diamond-Black Hand Grip P/N 56100199 (1") or 56100202 (7/8").

56000133	Right Hand (upright position).	\$99.95
56000134	Left Hand (upright position).	\$99.95



A. ROUND BAR END MIRROR – SATIN BLACK

B. DIAMOND-BLACK HAND GRIPS – BAR END MIRRORS*

Shroud your bike in mystery. This blacked-out hand and foot control collection features distinctive knurled surfaces that expose the raw billet aluminum for a dramatic contrast. Designed to age and break-in like a pair of comfortable stone-washed jeans, the satin black finish will complement both high-gloss and denim paint colors. Designed for use with Bar End Mirrors, these stripped-down Hand Grips feature glue-less installation that can be easily removed for service without damage. Grip End Caps are sold separately.

56100199 For 1" Diameter Bar. **\$99.95**
Fits '96-later VRSC, XL, XR, Dyna (except FXDLS), '96-'15 Softail (except FLSTNSE, FXSBSE and '11-'12 FLSTSE) and '96-'07 Touring models. Installation requires separate purchase of Bar End Mirrors P/N 56000133 and 56000134 or End Caps P/N 55900114.

56100202 For 7/8" Diameter Bar. **\$99.95**
Fits '15-later XG models. Installation requires separate purchase of Bar End Mirrors P/N 56000133 and 56000134 or End Caps P/N 55900114.



A. ROUND BAR END MIRROR – SATIN BLACK



B. DIAMOND-BLACK HAND GRIPS – BAR END MIRRORS (56100199 SHOWN)

C. EDGE CUT DOME MIRRORS*

Keep an eye on everything, while everyone keeps an eye on you. These compact billet mirrors feature glass-smooth domed shells and wet-look black surfaces to reflect a new contemporary style. The mirrors feature a precision machined edge that exposes three bands of satin aluminum for a brilliant contrast, and sleek round stems to keep the mirrors close to the controls for a tight tucked-in profile.

56000090 **\$229.95**
Fits '82-later models (except VRSCF, XG750A, '14-'16 FLHR, FLHRC and FLHRSE, '11-'13 FLHTCUSE, '14-later FLHTKSE and '18-later FLTRXSE). Does not fit XL1200X models with mirrors mounted below the handlebar.

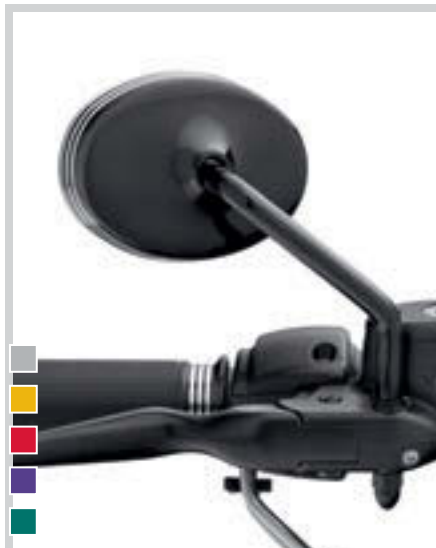

C. EDGE CUT DOME MIRRORS

*Harley-Davidson Motor Company cannot test and make specific fitment recommendations concerning every possible mirror and handlebar combination. Therefore, after installing new mirrors or handlebars and before operating the motorcycle, check to ensure that the mirrors provide the operator a clear view to the rear.

Notice: The prices appearing in this catalog are the manufacturer's suggested retail prices. Actual retail prices may vary.

CONTROLS 619

Mirrors

NEW



NEW



D. DOMINION MIRRORS – GLOSS BLACK

D. DOMINION MIRRORS – BRONZE

D. DOMINION™ COLLECTION MIRRORS*

Express your bold, renegade attitude. The Dominion™ Collection Mirrors let you set your own styling direction. Crafted from aluminum, these mirrors feature a rugged machined surface that allows you to create your own unique look.

Fits '82-later models (except VRSCF, XG750A, '14-'16 FLHR, FLHRC and FLHRSE, '11-'13 FLHTCUSE, '14-later FLHTKSE and '18-later FLTRXSE). Does not fit XL1200X models with mirrors mounted below the handlebar.

56000136 Gloss Black. **\$219.95**

56000137 Bronze. **\$219.95**

E. MIRRORS WITH AUXILIARY RUNNING LIGHT AND DIRECTIONAL INDICATOR*

Function and style in one package. This forged mirror combines a traditional swept shape with a contemporary addition – forward-facing auxiliary lighting. Smoked lenses hide bands of amber LED lamps that glow as running lamps when the ignition is on and add a fast-acting auxiliary directional indicator when the turn signals are activated. The forward-facing eye-level lamps command additional attention from oncoming traffic. Both mirrors flash when the emergency hazard lights are activated. The wiring is concealed in the housing and stem and is easily connected to the Original Equipment wiring harness. Available in mirror chrome or satin black finish.

Fits '14-later Touring (except Road King® and Road Glide®) and Trike models.

56000080 Chrome. **\$319.95**

56000081 Satin Black. **\$319.95**

Fits '97-later models (except VRSCF, XG, XL1200X, XL1200XS, FXDLS, FLSS, FLSTFBFS, FXCWC, '18-later Softail® and '14-later Touring). Also fits '14-later Road King models.

92059-07A Chrome. **\$309.95**

92068-08A Satin Black. **\$309.95**



E. MIRRORS WITH AUXILIARY RUNNING LIGHT AND DIRECTIONAL INDICATOR – CHROME

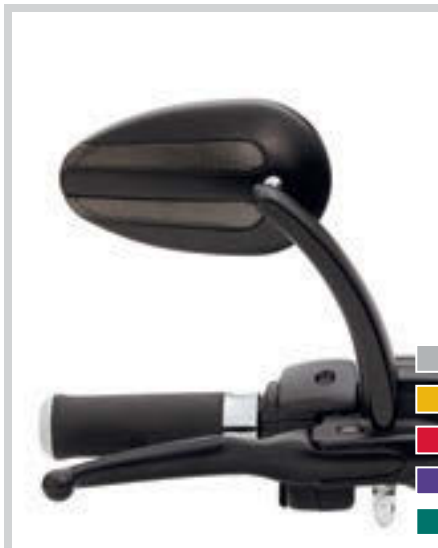

E. MIRRORS WITH AUXILIARY RUNNING LIGHT AND DIRECTIONAL INDICATOR – SATIN BLACK

*Harley-Davidson Motor Company cannot test and make specific fitment recommendations concerning every possible mirror and handlebar combination. Therefore, after installing new mirrors or handlebars and before operating the motorcycle, check to ensure that the mirrors provide the operator a clear view to the rear.

Model Family Fitment:

- V-ROD
- SPORTSTER
- DYNA
- SOFTAIL
- TOURING

Notice: The prices appearing in this catalog are the manufacturer's suggested retail prices. Actual retail prices may vary.

620 CONTROLS

Mirrors

CUSTOM MIRRORS

Fits '82-later models (except VRSCF, XG750A, '14-'16 FLHR, FLHRC and FLHRSE, '11-'13 FLHTCUSE, '14-later FLHTKSE and '18-later FLTRXSE). Does not fit XL1200X models with mirrors mounted below the handlebar.

- | | |
|---|-----------------|
| A. PROFILE CUSTOM MIRRORS WITH SLOTTED STEM* | |
| 91697-06A | \$139.95 |
| B. EDGE CUT STEM MIRRORS* | |
| 92441-10 | \$219.95 |
| C. BUCKSHOT MIRRORS* | |
| 92416-08 | \$219.95 |
| D. PROFILE CUSTOM MIRRORS – SATIN BLACK* | |
| 56000135 Satin Black with Solid Stem. | \$139.95 |
| E. DOME MIRRORS – SATIN BLACK* | |
| 92423-08A | \$199.95 |
| F. WILLIE G SKULL TEARDROP MIRRORS* | |
| 91315-04 | \$119.95 |
| G. TEARDROP MIRRORS* | |
| 1. 91971-98 Classic. | \$109.95 |
| 2. 91968-98 Harley-Davidson Script. | \$109.95 |
| H. SPLIT VISION MIRRORS* | |
| See even more of the world you just passed. This exclusive design Split Vision Mirror minimizes blind spots and provides a wide panoramic rear view of the left and right lane and the road behind you. The mirror features a large primary panel for normal view and a second outboard convex panel for a wider field of vision. Chrome-plated to a brilliant shine, the mirror's shape adds a contemporary touch to the traditional teardrop design. The deep embossed Harley-Davidson script and the curving slotted stem set this mirror apart from the others. | |
| 92190-06 | \$134.95 |



A. PROFILE CUSTOM MIRRORS WITH SLOTTED STEM



B. EDGE CUT STEM MIRRORS



C. BUCKSHOT MIRRORS



D. PROFILE CUSTOM MIRRORS – SATIN BLACK

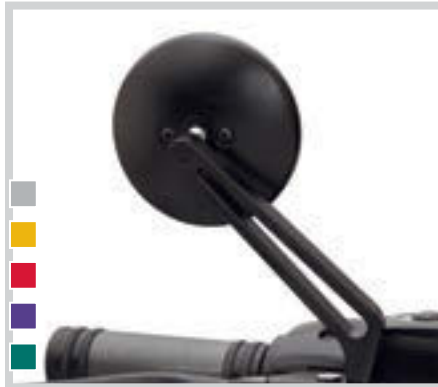

E. DOME MIRRORS – SATIN BLACK



F. WILLIE G SKULL TEARDROP MIRRORS

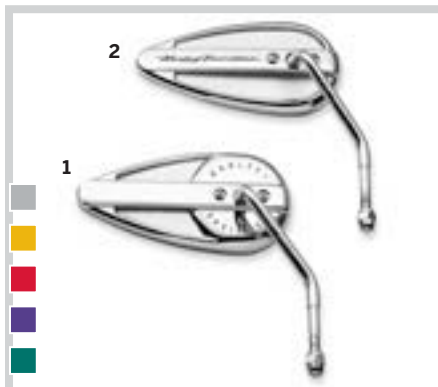

G. TEARDROP MIRRORS



H. SPLIT VISION MIRRORS

*Harley-Davidson Motor Company cannot test and make specific fitment recommendations concerning every possible mirror and handlebar combination. Therefore, after installing new mirrors or handlebars and before operating the motorcycle, check to ensure that the mirrors provide the operator a clear view to the rear.

Model Family Fitment:

- | | | |
|-----------|-------------|--------|
| ■ V-ROD | ■ SPORTSTER | ■ DYNA |
| ■ SOFTAIL | ■ TOURING | |

Notice: The prices appearing in this catalog are the manufacturer's suggested retail prices. Actual retail prices may vary.

CONTROLS 621

Mirrors



I. ONE-PIECE ROUND MIRRORS



J. LIVE TO RIDE LOGO COLLECTION MIRRORS – GOLD

I. ONE-PIECE ROUND MIRRORS*

Fits '82-later models (except VRSCF, XG750A, '14-'16 FLHR, FLHRC and FLHRSE, '11-'13 FLHTCUSE, '14-later FLHTKSE and '18-later FLTRXSE). Does not fit XL1200X models with mirrors mounted below the handlebar.

91931-92T	Short Stem, Left Side.	\$34.95
91930-92T	Short Stem, Right Side.	\$34.95

J. LIVE TO RIDE LOGO COLLECTION MIRRORS*

Fits '82-later models (except VRSCF, XG750A, '14-'16 FLHR, FLHRC and FLHRSE, '11-'13 FLHTCUSE, '14-later FLHTKSE and '18-later FLTRXSE). Does not fit XL1200X models with mirrors mounted below the handlebar.

1. One-Piece Short Stem Mirrors

91866-90T	Gold, Left.	\$49.95
91864-90T	Gold, Right.	\$49.95



K. TAPERED MIRRORS – BLACK



K. TAPERED MIRRORS – CHROME

K. TAPERED MIRRORS*

Update your Harley® motorcycle with the latest style in mirrors. This 2003-later Original Equipment style tapered mirror provides improved rearward visibility, offers a wider range of adjustment and eliminates the rear fasteners for a cleaner look. Available in your choice of satin black or chrome finish.

Fits '82-later models (except VRSCF, XG750A, '14-'16 FLHR, FLHRC and FLHRSE, '11-'13 FLHTCUSE, '14-later FLHTKSE and '18-later FLTRXSE). Does not fit XL1200X models with mirrors mounted below the handlebar.

92023-03A	Black – Short Stem Kit.	\$79.95
91982-03B	Black – Short Stem, Right.	\$39.95
91983-03B	Black – Short Stem, Left.	\$39.95
91909-03B	Black – Long Stem, Right.	\$39.95
91910-03B	Black – Long Stem, Left.	\$39.95
92022-03A	Chrome – Short Stem Kit.	\$79.95
91840-03B	Chrome – Short Stem, Right.	\$39.95
91845-03B	Chrome – Short Stem, Left.	\$39.95
91846-03B	Chrome – Long Stem, Right.	\$39.95
91848-03B	Chrome – Long Stem, Left.	\$39.95



L. MIRROR EXTENSION KIT – CHROME



L. MIRROR EXTENSION KIT – SATIN BLACK

L. MIRROR EXTENSION KIT*

See what's behind you. The Mirror Extension Kit improves visibility to the rear of your bike by repositioning mirrors outward approximately 2.0" and upward 1.0", clearing your field of view and allowing you to see past your shoulders. Available in your choice of chrome or satin black finish to match your mirrors and hand controls. Easy to install extenders fit a wide selection of Harley-Davidson® Original Equipment and accessory mirrors.

Fits '06-'17 Dyna® and '08-'14 Softail® models.

56000039	Chrome.	\$59.95
56000042	Satin Black.	\$59.95

M. MIRROR EXTENSION KIT*

Chrome-plated extenders relocate mirrors approximately two inches higher.

91907-87 **\$29.95**

Fits all models (except VRSCF models, XG750A models, and XL1200X models with mirrors mounted below the handlebars).



M. MIRROR EXTENSION KIT

*Harley-Davidson Motor Company cannot test and make specific fitment recommendations concerning every possible mirror and handlebar combination. Therefore, after installing new mirrors or handlebars and before operating the motorcycle, check to ensure that the mirrors provide the operator a clear view to the rear.

Notice: The prices appearing in this catalog are the manufacturer's suggested retail prices. Actual retail prices may vary.

622 CONTROLS

Hand Controls

A. HAND CONTROL LEVER KIT

Continue the custom theme with accessory Hand Control Levers. Cast from aluminum, these levers feature a custom finish designed to match accessory chrome hand controls or complement Original Equipment-style black components. Clutch anti-rattle clip and new pivot bushing included.

Fits '14-later XL models.

36700053A	Chrome.	\$139.95
36700052	Black.	\$99.95

Fits '96-'03 XL, '96-'17 Dyna® (except '16-'17 FXDLS), '96-'14 Softail® and '96-'07 Touring models. Does not fit Police or models equipped with hydraulic clutch.

45075-07	Chrome.	\$119.95
44994-07	Black.	\$99.95
55798-10A	Edge Cut.	\$139.95

Fits '04-'13 XL and XR models.

44992-07	Chrome.	\$119.95
46944-07A	Black.	\$99.95

Fits '06-'17 VRSC™ models.

42270-06B	Chrome.	\$159.95
42275-07A	Black.	\$99.95

Fits '02-'05 VRSC and '96-'06 Dyna, Softail and Touring models equipped with hydraulic clutch.

46114-07	Chrome.	\$119.95
-----------------	---------	-----------------

Fits '15-'17 Softail models (except FLSS, FLSTFBS and FXSE).

36700104	Chrome.	\$139.95
36700105	Black.	\$139.95

Fits '18-later Softail models (except FXDRS, FXFB and FXFBS).

36700209	Chrome.	\$139.95
36700210	Black.	\$139.95
36700211	Edge Cut.	\$159.95

Fits '17-later Touring models. Does not fit Trike models.

41700422A	Chrome.	\$139.95
41700421A	Black.	\$139.95
41700424A	Edge Cut.	\$159.95
41700425A	Slotted Chrome.	\$159.95

Fits '14-'16 Touring models equipped with hydraulic clutch. Does not fit Trike models.

36700065	Chrome.	\$139.95
36700064	Black.	\$139.95
36700067	Edge Cut.	\$159.95
36700066	Slotted Chrome.	\$159.95

Fits '14-'16 FLHR and FLHRC and '08-'13 Touring and Trike models. Does not fit models equipped with hydraulic clutch.

38843-08	Chrome.	\$139.95
38845-08	Black.	\$139.95
36700004	Edge Cut.	\$139.95
38853-08	Slotted Chrome.	\$159.95

Fits '17-later Trike models.

41700423A	Chrome.	\$139.95
------------------	---------	-----------------

Fits '14-'16 Trike models.

36700091	Chrome.	\$139.95
-----------------	---------	-----------------



A. CHROME HAND CONTROL LEVERS



A. BLACK HAND CONTROL LEVERS



A. EDGE CUT HAND CONTROL LEVERS



A. SLOTTED HAND CONTROL LEVER KIT

Notice: The prices appearing in this catalog are the manufacturer's suggested retail prices. Actual retail prices may vary.

CONTROLS 623

Hand Controls



B. CHROME CLUTCH BRACKET AND MASTER CYLINDER KIT – (41700190 SHOWN)



B. CHROME CLUTCH BRACKET AND MASTER CYLINDER KIT – (45355-08 SHOWN)



B. CHROME CLUTCH BRACKET AND MASTER CYLINDER KIT – (42117-08A SHOWN)



B. CHROME CLUTCH AND BRAKE MASTER CYLINDER KIT – (46112-02F SHOWN)



B. CHROME CLUTCH AND BRAKE MASTER CYLINDER KIT – (41700263C SHOWN)



B. CHROME CLUTCH AND BRAKE MASTER CYLINDER KIT – (41700324A SHOWN)



B. CHROME CLUTCH AND BRAKE MASTER CYLINDER KIT – (41700440 SHOWN)



B. CHROME CLUTCH AND BRAKE MASTER CYLINDER KIT – (41700463 SHOWN)

B. CHROME CLUTCH BRACKET AND MASTER CYLINDER RESERVOIR KIT

Replace your stock painted aluminum controls with brilliant chrome, without compromising quality. This kit is manufactured from Original Equipment components and includes a Chrome Master Cylinder Cover. When combined with Chrome Switch Housing Kit, Chrome Switch Caps and other Harley-Davidson® Genuine Motor Accessories, this front brake control kit provides a look that does more than stop your bike – it can stop traffic.

41700190 **\$324.95**

Fits '14-later XL models with single disc front brake with ABS.

41700262 **\$324.95**

Fits '14-later XL models with single disc front without ABS.

45284-99D **\$359.95**

Fits '96-'03 XL, '96-'05 Dyna® and Softail® models with single disc front brakes and cable operated clutch.

45281-99D **\$359.95**

Fits '96-'03 XL, '96-'05 Dyna and Softail and '96-'04 Touring models with dual disc front brakes and cable operated clutch.

45355-08 **\$359.95**

Fits '08-'17 Dyna (except FXDF, FXDLS and '14-'17 FXDL) and '08-'14 Softail models equipped with single disc front brakes and cable operated clutch.

41700480 **\$399.95**

Fits '18-later Softail (except FXDRS, FXFB and FXFBS) models.

36700100 **\$414.95**

Fits '15-'17 Softail models with cable operated clutch.

45355-06A **\$359.95**

Fits '06-'07 Dyna and Softail models equipped with single disc front brakes and cable operated clutch.

42100-06D **\$639.95**

Fits '06-'17 VRSC™ models.

46112-02F **\$399.95**

Fits '02-'05 VRSC models. Also fits hydraulic clutch-equipped '96-'05 Dyna and Softail and '96-'04 Touring models with dual disc front brakes.

41700440 **\$649.95**

Fits '17-later Touring and '19-later Trike models (except Road Glide®).

41700263C **\$649.95**

Fit '14-'16 Touring models (except Road Glide) with hydraulic clutch. Does not fit Trike models.

42117-08A **\$399.95**

Fits '08-'16 Touring models with cable operated clutch.

46418-05A **\$359.95**

Fits '05-'07 Touring models with cable operated clutch.

41700441 **\$649.95**

Fits '17-'18 Trike models.

41700330 **\$649.95**

Fits '14-'16 Trike models with hydraulic clutch.

41700463 **\$649.95**

Fits '17-later Road Glide models.

41700324A **\$649.95**

Fits '15-'16 Road Glide models.

Model Family Fitment:

- V-ROD
- SPORTSTER
- DYNA
- SOFTAIL
- TOURING

Notice: The prices appearing in this catalog are the manufacturer's suggested retail prices. Actual retail prices may vary.

624 CONTROLS

Hand Controls

A. SWITCH HOUSING KIT – CHROME

Convert your handlebar switch housings from black to brilliant chrome. Complete kit includes left and right housings sets. No switches or wiring required.

70222-96B **\$139.95**
Fits '02-'17 VRSC™, '96-'13 XL, '08-'12 XR, '96-'11 Dyna®, and Softail® (except FXSTDSE) and '96-'13 Road King® (except FLHRSE) models.

71826-11 **\$99.95**
Fits '14-later XL, '12-'17 Dyna and '11-later Softail models not equipped with cruise control (except '18-later FLDE, FLHC, FLHCS and FLSEB).

71500442 **\$99.95**
Fits '16-later Softail models equipped with Cruise Control.

71500185 **\$149.95**
Fits '14-later Touring and Trike models.

70223-96B **\$149.95**
Fits '96-'13 FLHT and FLHTC, '06-'13 FLHX and FLTRX and '10-'11 FLHXXX models without cruise control.

70228-96C **\$149.95**
Fits '96-'13 FLHTCU, FLHTK, FLTR and FLTRU, '02-'13 FLHRC and '09-'13 FLHTCUTG models. Also fits '02-'13 FLHR models equipped with cruise control.

71813-09 **\$149.95**
Fits '96-'13 FLHT, FLHTC, FLHX and FLTRX and '10-'11 FLHXXX models equipped with cruise control.

B. HANDLEBAR RESERVOIR COVER SET

This kit includes a chrome-plated clutch bracket, handlebar control clamps, master cylinder cover and hardware to completely finish chroming the hand controls. Combine with chrome-plated Switch Housing Kit P/N 70222-96B to finish the look. Cannot be used with Auxiliary Lighting Kits.

46099-98 **\$79.95**
Fits '96-'03 XL, '96-'17 Dyna, '96-'14 Softail and '96-'07 Touring models with dual disc front brakes. (Does not fit VRSC models or models equipped with hydraulic clutch.)

46098-98 **\$79.95**
Fits '96-'03 XL, '96-'17 Dyna and '96-'14 Softail models with single disc front brakes. (Does not fit models equipped with hydraulic clutch.)



A. SWITCH HOUSING KIT – CHROME
(71500185 SHOWN)



A. SWITCH HOUSING KIT – CHROME
(71500442 SHOWN)



A. SWITCH HOUSING KIT – CHROME
(70222-96B SHOWN)

A. SWITCH HOUSING KIT – CHROME
(70223-96B SHOWN)



B. HANDLEBAR RESERVOIR COVER SET

Model Family Fitment:

- V-ROD
- SPORTSTER
- DYNA
- SOFTAIL
- TOURING

Notice: The prices appearing in this catalog are the manufacturer's suggested retail prices. Actual retail prices may vary.

CONTROLS 625

Hand Controls



C. TURN SIGNAL EXTENSION CAPS – BLACK (71500179 SHOWN)

C. TURN SIGNAL EXTENSION CAPS – CHROME (71500180 SHOWN)

C. TURN SIGNAL EXTENSION CAPS

Make signaling simple. These Turn Signal Extension Caps allow riders to easily reach and activate turn signals without repositioning or removing their hands from the grips. The one-piece design features a contoured thumb extension that places the left and right hand signal control in a comfortable position. Available in chrome and black, these Extension Caps replace the stock turn signal switch caps without re-wiring.

Fits '14-later XL, '12-'17 Dyna® and '11-later Softail® models (except FLDE, FLHC, FLHCS, FLSE, FLSTSE and FXSBSE).

71500177 Black. **\$24.95**

71500178 Chrome. **\$24.95**

Fits '02-'17 VRSC™, '96-'13 XL, '08-'12 XR, '96-'11 Dyna, '96-'10 Softail and '96-'13 Touring and Trike models.

71500179 Black. **\$24.95**

71500180 Chrome. **\$24.95**

Fits '14-later Road King® and Freewheeler® models. Does not fit CVO™ models.

71500285 Black. **\$24.95**

71500411 Chrome. **\$24.95**

Fits '14-later Electra Glide®, Street Glide®, Ultra Limited, Road Glide® and Tri Glide® models. Does not fit CVO models.

71500286 Black. **\$24.95**

71500412 Chrome. **\$24.95**



D. SWITCH CAP KIT – CHROME (71500187A SHOWN)

D. SWITCH CAP KIT – CHROME

Not satisfied until everything you see is chrome? These Chrome Switch Cap Kits will add style to one of the most visible areas of your bike, the switches. Shaped for the same ergonomic feel as the Original Equipment hand control switches, these caps replace the stock black caps without re-wiring. The chrome switch caps complement other chrome hand control accessories (Chrome Master Cylinder Kit, Chrome Hand Levers, Chrome Switch Housings and Chrome Master Cylinder Cover) to complete the custom look.

71500187A **\$59.95**

Fits '16-later FLHTCU, FLHTCUL, FLHX, FLHXS, FLTRU, FLTRX, FLTRXS and '09-'18 FLHTCUTG models. Does not fit CVO models.

71500186 **\$49.95**

Fits '16-later Road King and '15-'18 Freewheeler models. Does not fit CVO models.

71500228A **\$59.95**

Fits '16-later FLHTK and FLHTKL models. Does not fit CVO models.

71500515 **\$59.95**

Fits '19-later FLHTCUTG models.

71500517 **\$49.95**

Fits '19-later FLRT models.

71500441 **\$34.95**

Fits '14-later XL, '12-'17 Dyna and '11-later Softail (except FLDE, FLHC and FLHCS) models. Kit includes switch cap for cruise-control equipped models.

71804-03 **\$24.95**

Fits '02-'17 VRSC and '96-'13 XL and XR, '96-'11 Dyna, '96-'13 FLHR and '98-'01 FLHRC models. FLHR models equipped with Cruise Control use Kit P/N 71808-03.

71500110 **\$26.95**

Fits '14-later XL, '12-'17 Dyna (except '16-'17 FXDLS), and '11-'15 Softail models.

71802-03 **\$32.95**

Fits '96-'13 FLHTCU, FLHTK, FLTR and FLTRU and '09-'13 FLHTCUTG models.

71816-09 **\$32.95**

Fits '96-'13 FLHT, FLHTC, FLHX and FLTRX and '10-'11 FLHXXX models equipped with cruise control.



D. SWITCH CAP KIT – CHROME (71500515 SHOWN)



D. SWITCH CAP KIT – CHROME (71500186 SHOWN)



D. SWITCH CAP KIT – CHROME (71500228A SHOWN)



D. SWITCH CAP KIT – CHROME (71500441 SHOWN)

Notice: The prices appearing in this catalog are the manufacturer's suggested retail prices. Actual retail prices may vary.

626 CONTROLS

Hand Controls

A. FRONT MASTER CYLINDER COVER — CHROME

Includes chrome-plated cover, gasket and decal. Easily installed with included stainless steel screws.

45078-96D Brake. **\$39.95**
Fits '02-'05 VRSC™, '96-'03 XL, '96-'05 Dyna® and Softail® and '96-'04 Touring models.

46424-05B Brake. **\$39.95**
Fits '06-'17 Dyna, '06-'14 Softail and '05-'07 Touring models. Also fits '14-later Trike brake master cylinder and '14-'16 Trike clutch master cylinders.

42313-07 Brake. **\$39.95**
Fits '07-later XL and XR models.

42123-08 Brake. **\$59.95**
Fits '08-later Touring and '09-'13 and '19-later Trike models.

36700094A Clutch. **\$59.95**
Fits '14-'16 Touring models equipped with hydraulic clutch. Does not fit Trike models.

42114-06A Brake & Clutch (pair). **\$129.95**
Fits '06-'17 VRSC models.

41700297 Brake. **\$49.95**
Fits '15-'17 Softail models.

41700442 Clutch. **\$64.95**
Fits '17-later Touring and '19-later Trike models.

37000278 Clutch. **\$59.95**
Fits '17-later Trike models.

B. EDGE CUT MASTER CYLINDER COVER

The Edge Cut master cylinder cover features a crisp anodized finish that is machined to expose the highlights or raw aluminum. The contrasting cut back look makes a powerful visual statement, and works great with both traditional and contemporary customizing styles. This cover is a direct replacement for the Original Equipment master cylinder cover. Easily installed kit includes cover, gasket, and black hardware.

41700334 Brake. **\$69.95**
Fits '06-'17 VRSC, '08-later Touring and '09-'13 Trike models.

36700119 Clutch. **\$69.95**
Fits '06-'17 VRSC, and '14-'16 Touring models equipped with hydraulic clutch.



**A. CHROME MASTER CYLINDER COVER
45078-96D**



**A. CHROME MASTER CYLINDER COVER
46424-05B**



**A. CHROME MASTER CYLINDER COVER
42123-08**



**A. CHROME MASTER CYLINDER COVER
42313-07**



**A. CHROME MASTER CYLINDER COVER
36700094A**



**A. CHROME MASTER CYLINDER COVER
42114-06A**



**B. EDGE CUT MASTER CYLINDER COVER
41700334**



**B. EDGE CUT MASTER CYLINDER COVER
36700119**

Notice: The prices appearing in this catalog are the manufacturer's suggested retail prices. Actual retail prices may vary.

CONTROLS 627

Hand Controls

CONTROLS



C. REAR MASTER CYLINDER COVER – CHROME (46463-08 SHOWN)



C. REAR MASTER CYLINDER COVER – CHROME

C. REAR MASTER CYLINDER COVER – CHROME

An easy way to add chrome to your bike is with this chrome-plated version of the stock master cylinder cover.

46463-08 **\$59.95**
Fits '08-later Touring models. Does not fit Trike models.

46425-05A **\$39.95**
Fits '06-'17 Dyna® non-ABS models, '06-'17 Softail® and '05-'07 Touring models.

45149-99C **\$39.95**
Fit '00-'05 Softail and '99-'04 Touring models.

D. BANJO BOLT KIT – CHROME

Replace the Original Equipment zinc finish brake line hardware with brilliant chrome custom banjo bolts.

41843-08 **\$49.95**
Fits '06-'17 VRSC™, '08-later Touring and '09-'13 Trike models.

E. SWITCH HOUSING HARDWARE KIT

Complete the chrome conversion with this Chrome Hardware Kit. Chrome-plated stainless steel hardware replaces the Original Equipment black hardware on the hand control switch housing, clutch and brake bracket clamps.

91124-03A **\$19.95**
Fits '96-later models (except 15-later XG, '04-later XL and XR and '15-later Softail, Touring and Trike).

F. REDUCED EFFORT CLUTCH KIT

Kit includes a new clutch spring and inner/outer ramps that significantly reduce clutch lever effort. Original Equipment on '06-later Twin Cam-equipped models.

36808-05 **\$49.95**
Fits '99-'05 Twin Cam-equipped models. Stock on '06-later Twin Cam-equipped models. This kit is not for use with Screamin' Eagle® Performance Parts.

G. THROTTLE CABLE CLIP – CHROME

Tie up the loose ends to complete your custom ride. When matched to Original Equipment black cables or available braided cables, these decorative clips link the throttle and idle cables for a clean custom look.

91274-04 **\$34.95**
Fits '84-later models with throttle/idle cables (except '15-later XG).



D. BANJO BOLT KIT – CHROME



E. SWITCH HOUSING HARDWARE KIT



F. REDUCED EFFORT CLUTCH KIT



G. THROTTLE CABLE CLIP – CHROME



Model Family Fitment:

- V-ROD
- SPORTSTER
- DYNA
- SOFTAIL
- TOURING

Notice: The prices appearing in this catalog are the manufacturer's suggested retail prices. Actual retail prices may vary.

628 CONTROLS

Hand Controls

A. LIGHTED HAND CONTROL SWITCHES

Add function and style to the Original Equipment hand controls. Lighted Hand Controls feature soft white LED backlighting that illuminates the switch function icons for enhanced nighttime visibility. You get at-a-glance identification and a modern up-to-date look. Kit includes plug-in switch packs for left- and right-hand controls.

71500248C **\$249.95**

Fits '14-later Touring (except Road King®) and '14-'18 FLHTCUTG models. Stock on '14-later CVO™ Touring models.

71500250B **\$249.95**

Fits '14-'16 FLHR and FLHRC models.



A. LIGHTED HAND CONTROL SWITCHES

B. CLUTCH FERRULE AND BANJO BOLT COVER KITS

These chrome-plated die-cast covers provide a custom look to your hand controls. The pair of tapered covers conceals the brake banjo bolt cable and the clutch cable or hydraulic line connections as they enter the hand controls. The two-piece design is easy to install and adds a finishing touch to Original Equipment or braided lines and cables. Kits are available for models with cable- or hydraulic-operated clutch.

41300061 Brake and Cable Clutch. **\$34.95**

Fits '84-later models (except VRSC™, '15-later XG, and '08-later XR). Will not fit models equipped with hydraulic clutch. Some models may require rotation of the front master cylinder banjo fitting. See the service manual for Brake systems procedures.

41300062 Brake and Hydraulic Clutch. **\$34.95**

Fits '09-later VRSC, '14-later Touring (except Road Glide®), '14-later Trike and '08-later CVO models and bikes equipped with hydraulic clutch. Does not fit '15-later Softail® models. Some models may require rotation of the front master cylinder banjo fitting. See the service manual for Brake systems procedures.



A. LIGHTED HAND CONTROL SWITCHES – (71500248C SHOWN)



A. LIGHTED HAND CONTROL SWITCHES – (71500250B SHOWN)

C. CLUTCH FERRULE AND BANJO BOLT COVER KIT – CHROME

Die-cast chrome covers provide a custom look to your stock banjo bolts and handlebar clutch ferrule. Fits clutch ferrule on handlebar and banjo bolts on brake master cylinders and calipers. Installs in seconds.

32714-98A **\$34.95**

Fits '84-later models with stock master cylinder and calipers (except '02-later VRSC, '15-later XG, '04-later XL, and '08-later Touring and Trike). Will not fit models equipped with hydraulic clutch.



B. CLUTCH FERRULE AND BANJO BOLT COVER KITS



B. BRAKE & CABLE CLUTCH



B. BRAKE & HYDRAULIC CLUTCH



C. CLUTCH FERRULE AND BANJO BOLT COVER KIT – CHROME

Model Family Fitment:

- V-ROD
- SPORTSTER
- DYNA
- SOFTAIL
- TOURING

Notice: The prices appearing in this catalog are the manufacturer's suggested retail prices. Actual retail prices may vary.

CONTROLS 629

Hand Controls



D. CRUISE CONTROL KIT (41000369 SHOWN)



D. CRUISE CONTROL KIT

For long-distance runs, there's nothing better than letting your bike do all the work. This Cruise Control Kit puts you just minutes away from true touring bliss. Unlike mechanical throttle controls or friction thumb wheels, this complete electronic speed control allows you to set and maintain constant speed at the touch of a button. Your dealer will install the new hand controls, enable the cruise control function in the Electronic Control Module (ECM), and you're ready to roll. No splicing into the wiring harness to install. Kit includes updated switch housings and all necessary hardware.

41000369 **\$249.95**

Fits '16-later Softail® models. Original Equipment on '16-'17 FLSS, FLSTC, FLSTFBS, FLSTN and FXSE models and '18-later FLHC, FLHCS and FLSB models. Dealer Digital Technician™ software update is required.

77196-08 **\$249.95**

Fits '08-'09 FLHT, '08-'13 FLHTC and FLHX, '10-'13 FLTRX and '10-'11 FLHXXX models.



D. CRUISE CONTROL KIT (77196-08 SHOWN)



E. HANDLEBAR SWITCH CONTROL KIT

E. HANDLEBAR SWITCH CONTROL KIT

Updated for use with '07-later models equipped with clutch interlock system. This exclusive Harley-Davidson® kit simplifies the switch to custom style handlebars. Kit features the Original Equipment left and right switch housings, 60.0" wiring harness and all necessary hardware.

70239-07 **\$159.95**

Fits '96-'13 XL, '08-'13 XR, '96-'11 Dyna® and '96-'10 Softail models (except '07-'10 FLSTF). Also fits '96-'13 Touring models without cruise control or radio controls.

F. AUXILIARY ACCESSORY SWITCH HOUSING KIT

Keep your eyes on the road and your hands on the grips with these easy-to-reach Auxiliary Accessory Switch Housings. Available for left and right hand control clusters, these housings will allow you to install up to six switches (when two housings are used) to control various electrical devices. Available in black to match Original Equipment switch housings or a bright chrome finish to complement accessory Chrome Switch Housing Kits. All necessary mounting hardware is included. Switches sold separately.

Fits '96-later VRSC™, XL, XR, Dyna, Softail (except FLSB, FLSTF, FLSTFB, FLSTFBS, FXDRS, FXSB and FXSE) and Touring models (except '15-later Road Glide® and FLHRXS). Does not fit Trike models. Does not fit models equipped with Large Diameter Handlebars, Handlebar-Mounted GPS, Boom!™ Audio Cruiser Amp & Speaker Kits or Tour-Pak® Mounted CD Changer P/N 77184-01. '04-later XL and XR models require separate purchase of (2) Screw P/N 3832M.

70213-02C Chrome Left Side. **\$39.95**

70248-02B Black Left Side. **\$39.95**

Fits '96-later VRSC, XL, XR, Dyna, Softail (except FLSB, FLSTF, FLSTFB, FLSTFBS, FXDRS and FXSE) and Touring models (except '15-later Road Glide and FLHRXS). Does not fit Trike models. Does not fit models equipped with Large Diameter Handlebars, Handlebar-Mounted GPS, Boom! Audio Cruiser Amp & Speaker Kits or Tour-Pak Mounted CD Changer P/N 77184-01. '04-later XL and XR models require separate purchase of (2) Screw P/N 3832M.

70255-02B Chrome Right Side. **\$39.95**



F. AUXILIARY ACCESSORY SWITCH HOUSING KIT – CHROME (SHOWN WITH AUXILIARY ON/OFF SWITCH)



G. AUXILIARY ON/OFF SWITCH KIT

Styled to match the Original Equipment hand controls. These Auxiliary On/Off switches allow you to control additional electrical accessories with the touch of a finger when installed in the Auxiliary Accessory Switch Housing. Switches sold individually.

71718-02 **\$19.95**

Fits Auxiliary Accessory Switch Housing Kits P/N 70255-02B, 70256-02, 70213-02C and 70248-02B.



F. AUXILIARY ACCESSORY SWITCH HOUSING KIT – BLACK (SHOWN WITH AUXILIARY ON/OFF SWITCH)



G. AUXILIARY ON/OFF SWITCH KIT

Notice: The prices appearing in this catalog are the manufacturer's suggested retail prices. Actual retail prices may vary.

COMFORT, STYLE OR BOTH?

Every person is unique. Your overall height, arm reach, upper body length and riding style all dictate your relationship to the bike's controls. Add in the desire for a unique, custom look and your handlebar options multiply exponentially.*

YOUR RIDING POSITION

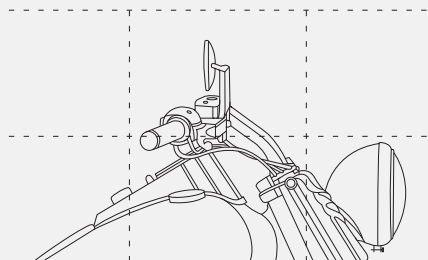

DRAG HANDLEBAR*

Narrow, flat and more aggressive, drag bars provide a straight elbow and neutral hand and wrist position. For maximum comfort, drag bars can be positioned with curved or straight risers to minimize stretch to the controls.

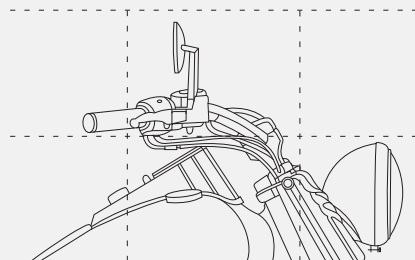

BEACH HANDLEBAR*

Low and wide, a beach bar spreads your arms and gives you room to breathe. Ideal for the rider with long arms, beach bars can be a little too wide for many riders. While selecting a bar, make sure you can reach the hand controls when the handlebar is fully turned.

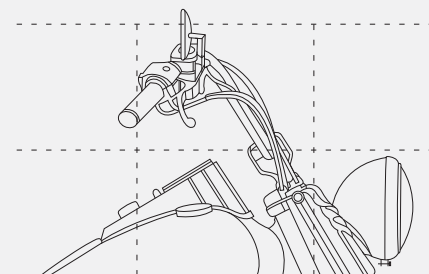

APE HANGER & TALLBOY® HANDLEBAR*

Tall and wide, ape hanger and Tallboy® handlebars provide a classic "fists-in-the-wind" look and can add long-haul comfort for riders with long arms. Because handlebar height is regulated in many areas, check local laws before installing a tall handlebar.

CHIZELED HANDLEBAR*

For cutting edge style, a Chizeled Bar combines the hands-up feel of a mini-ape with the narrow width of a drag bar. The bar's shoulder-width design keeps the elbows in and the arms straight ahead, and the wrist and hands fall in a neutral palms-down grip.

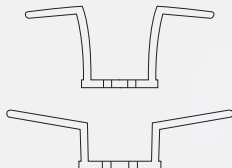

HANDLEBAR DIMENSIONS

(IN INCHES)

Handlebar Kit	Bar Diameter	Width	Pull Back	Rise	Base Width	Knurl Center	Finish
55800035A	1.00	29.25	3.80	0.00	9.00	3.14	Satin Black
55800103	1.00	25.75	4.30	8.30	8.50	3.22	Satin Black
55800188	1.25	32.00	7.00	8.00	10.00	3.22	Chrome
55800198	1.00	25.75	4.30	8.30	8.50	3.22	Chrome
55800224	0.88	30.00	1.90	8.25	8.40	3.22	Satin Black
55800225	0.88	30.50	1.60	0.00	12.00	3.22	Satin Black
55800237	0.88	30.00	1.90	8.25	8.40	3.22	Chrome
55800238	0.88	30.50	1.60	0.00	12.00	3.22	Chrome
55800252	1.25	33.75	7.25	10.25	10.00	3.22	Chrome
55800298	1.25**	35.25	5.25	10.50	16.00	3.50	Chrome
55800299	1.25**	35.25	5.25	10.50	16.00	3.50	Gloss Black
55800341	1.00	30.75	5.00	-3.00	12.00	3.22	Chrome
55800342	1.00	30.75	5.00	-3.00	12.00	3.22	Satin Black
55800345	1.00	28.50	4.75	3.75	7.50	3.14	Satin Black
55800386	1.25	31.25	7.25	11.25	9.63	3.20	Chrome
55800388	1.25	31.25	7.25	11.25	9.63	3.20	Gloss Black
55800421	1.25**	27.50	4.00	12.00	9.50	3.00	Chrome
55800422	1.25**	27.50	4.00	12.00	9.50	3.00	Gloss Black
55800430	1.00	27.50	5.50	4.00	8.50	3.14	Chrome
55800431	1.00	27.50	5.50	4.00	8.50	3.14	Gloss Black
55800439	1.25	31.00	6.25	14.00	11.25	3.00	Chrome
55800440	1.25	31.00	6.25	14.00	11.25	3.00	Gloss Black
55800548A	1.25	33.75	9.25	14.75	12.50	3.14	Chrome
55800549A	1.25	33.75	9.25	14.75	12.50	3.14	Satin Black
55800550A	1.25	34.75	10.00	12.25	12.50	3.14	Chrome
55800551A	1.25	34.75	10.00	12.25	12.50	3.14	Satin Black
55800563	1.00	30.00	9.25	5.25	11.75	3.14	Polished SST
55800568	1.25	31.60	6.42	9.00	11.25	3.00	Chrome
55800569	1.25	31.60	6.42	9.00	11.25	3.00	Gloss Black
55800579	1.00	31.75	6.25	7.00	9.00	3.50	Gloss Black
55800580	1.00	31.00	4.50	7.25	10.00	3.14	Chrome
55800587	1.00	31.00	4.50	7.25	10.00	3.14	Gloss Black
55800589	1.00	30.81	13.09	6.63	15.14	3.48	Chrome
55800590	1.00	30.81	13.09	6.63	15.14	3.48	Gloss Black
55800591	1.00	32.39	6.03	11.17	16.16	3.48	Chrome
55800592	1.00	32.39	6.03	11.17	16.16	3.48	Gloss Black

Handlebar Kit	Bar Diameter	Width	Pull Back	Rise	Base Width	Knurl Center	Finish
55800712	1.25	34.68	7.09	7.75	10.20	3.22	Chrome
55800714	1.25	34.68	7.09	7.75	10.20	3.22	Gloss Black
55800715	1.00	31.60	7.20	7.03	9.84	3.14	Chrome
55800717	1.00	31.60	7.20	7.03	9.84	3.14	Black
55800719	1.00	34.64	10.33	4.97	13.05	3.14	Chrome
55800721	1.00	34.64	10.33	4.97	13.05	3.14	Gloss Black
55800748	1.25	35.44	3.69	12.48	11.00	3.54	Gloss Black
55800749	1.25	35.44	3.69	12.48	11.00	3.54	Chrome
55800750	1.25	35.44	3.71	16.46	11.00	3.54	Chrome
55800751	1.25	35.44	3.71	16.46	11.00	3.54	Gloss Black
55864-09	1.00	31.25	5.00	12.00	11.50	3.14	Satin Black
55914-98	1.00	30.75	7.50	12.25	15.00	3.50	Polished SST
55919-82T	1.00	32.50	9.00	5.00	14.25	3.50	Chrome
55954-00	1.00	30.00	9.00	9.50	13.75	3.14	Chrome
55967-08	1.25	35.50	11.50	4.75	12.25	3.50	Chrome
55975-08A	1.00	30.25	5.75	6.75	9.00	-	Chrome
55977-09A	1.25	30.50	7.00	0.00	6.50	3.50	Satin Black
55985-10	1.00	30.25	5.75	6.75	9.00	-	Satin Black
56021-04B	1.00	31.00	5.75	6.00	8.75	4.25	Chrome
56036-08	1.00	31.75	6.50	10.00	15.75	3.50	Chrome
56075-07	1.00	32.00	6.50	8.75	10.00	3.14	Satin Black
56079-93T	1.00	32.00	6.50	8.75	10.00	3.14	Chrome
56085-83T	1.00	31.00	5.75	6.00	7.75	3.14	Chrome
56166-08	1.00	32.00	5.50	11.25	13.00	3.14	Chrome
56180-08	1.00	30.00	9.00	9.50	13.75	3.14	Chrome
56558-95	1.00	27.00	4.00	0.00	8.50	3.14	Chrome
56563-95	1.00	31.50	5.50	9.75	9.50	3.14	Chrome
56623-99A	1.00	31.25	5.00	12.00	11.50	3.14	Chrome
56760-04	1.25	35.50	4.75	12.00	12.25	4.75	Chrome
56857-05	1.25	32.60	6.60	9.01	9.00	3.14	Chrome
56902-08	1.00	31.25	5.00	12.00	11.50	3.14	Polished SST
56943-10B	1.25**	33.54	7.45	12.17	11.00	3.50	Chrome
57466-10	1.00	28.80	6.25	5.70	7.00	3.14	Satin Black
57474-11	1.00	35.00	1.75	12.00	16.00	3.50	Chrome
57485-11	1.00	35.00	1.75	12.00	16.00	3.50	Satin Black

CHOOSING YOUR HANDLEBAR

RISE is the vertical distance between a handlebar's tip and its base. Adding risers to bars that sit too low can help put hand grips into your sweet spot.

PULL BACK is the distance the handlebar tips come back toward the rider. Greater pull back can eliminate the long reach to the bar for a shorter rider.

WIDTH is measured from tip-to-tip. Make sure the bar isn't too wide so it pulls your hands off the grips when turning.

KNURL CENTER is the distance between the center line of the bar's knurling. The measurement should match the riser dimension to maximize clamping pressure.

*NOTE: Installation of some handlebars and risers may require a change in clutch and/or throttle cable and brake lines for some models. Handlebar height is regulated in many areas. Check local laws before installation. **1.25" Fat Bar base necks down to fit 1.0" handlebar clamp.

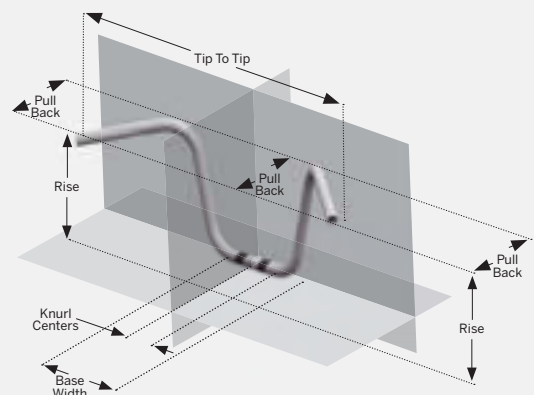

632 CONTROLS

Handlebars – Dyna®/Softail®

A. EXTREME REACH® HANDLEBAR*

Extensively tested with a panel of riders between 5'-0" to 5'-5" tall, this Extreme Reach® Handlebar and recommended riser combination was proven to be the most ergonomically pleasing handlebar for many Dyna® and Softail® models. Shaped to provide the ideal balance of pull back and width, this handlebar produces an overall pull back of 11.0" and a tip-to-tip width of 30.0" when combined with Curved Riser Kit P/N 56266-09 (sold separately). Your hands fall naturally in place and the narrow width reduces your stretch while making low-speed turns and parking lot maneuvers.

55800563 **\$69.95**

Fits '06-'17 Dyna (except '14-'17 FXDL) and '00-'17 Softail models (except FLSS, FLSTFB, FXCW, FXCWC, FXS, FXSB, FXSTD and Springer™). Does not fit CVO™ models. All models require separate purchase of additional installation components.

See your Dealer for cables, lines and additional installation components required, or visit www.H-D.com/store and search part number 55800563.



A. EXTREME REACH HANDLEBAR



A. EXTREME REACH HANDLEBAR WITH RISER KIT P/N 56266-09

B. REACH HANDLEBAR* – 1.0"

Recommended for riders between 5'-2" and 5'-8" tall, this Reach Handlebar is shaped to position the hand controls closer to the rider for optimized elbow and wrist position. Designed to provide the ideal balance of pull back and width, this handlebar allows your hands fall naturally in place. The narrower width reduces your stretch while making low-speed turns and parking lot maneuvers, and the overall effect is improved confidence and long-range comfort for short-armed riders.

Fits '18-later FLDE, FLHC, FLHCS, FLSL, FXBB and FXLR models. All models require separate purchase of additional installation components.

55800715 Chrome. **\$89.95**

55800717 Black. **\$89.95**

See your Dealer for cables, lines and additional installation components required, or visit www.H-D.com/store and search part number 55800715 or 55800717.



A. EXTREME REACH HANDLEBAR (SHOWN WITH CURVED RISER KIT)



B. REACH HANDLEBAR – 1.0"

*NOTE: Installation of some handlebars and risers may require a change in clutch and/or throttle cable and brake lines for some models. Handlebar height is regulated in many areas. Check local laws before installation.

Notice: The prices appearing in this catalog are the manufacturer's suggested retail prices. Actual retail prices may vary.

CONTROLS 633

Handlebars – Dyna®/Softail®



C. FAT REACH HANDLEBAR – 1.25"

C. FAT REACH® HANDLEBAR* – 1.25"

Slammed and styled for a low-profile look, this 1.25" handlebar places the hand controls closer to the rider for an optimized elbow bend and wrist position, offering improved confidence and long-range comfort for shorter-armed riders.

Fits '18-later FLFB, FLFBS, FLHC, FLHCS, FLBS, FLSL, FXBB, FXBR, FXBRS, FXDRS, FXFB, FXFBS and FXLR models. FLDE, FLHC, FLHCS, FLSL, FXBB and FXLR models require separate purchase of 1.25" handlebar riser kit. All models require separate purchase of additional installation components.

55800712	Chrome.	\$279.95
55800714	Gloss Black.	\$279.95

See your Dealer for cables, lines and additional installation components required, or visit www.H-D.com/store and search part number 55800712 or 55800714.

D. FXSB SOFTAIL® REACH HANDLEBAR*

Shaped to provide the ideal balance of pull back and width, this chrome-plated bar places riders closer to the controls for a comfortable upright riding position. When combined with the Original Equipment Softail® Breakout® curved risers, the Reach® Handlebar provides an overall pull back of 7.0". The 1.25" diameter handlebar can be internally wired for a clean look.

55800188	Chrome.	\$279.95
-----------------	---------	-----------------

Fits '13-'17 FXSB models. Separate purchase of additional components required.

See your Dealer for cables, lines and additional installation components required, or visit www.H-D.com/store and search part number 55800188.



D. FXSB SOFTAIL REACH HANDLEBAR

E. TALLBOY® HANDLEBAR – 1.0"

Recommended for riders 5'9" and taller, this 1.0" Tallboy® handlebar enables long-armed riders to more comfortably fit and maneuver Softail motorcycle. Shaped to provide the ideal balance of rise and width, this bar places the hands in a neutral position and stretches the arms to reduce the bend at the elbow.

Fits '18-later FLDE, FLHC, FLHCS, FLSL, FXBB and FXLR models. All models require separate purchase of additional installation components.

55800719	Chrome.	\$89.95
55800721	Gloss Black.	\$89.95

See your Dealer for cables, lines and additional installation components required, or visit www.H-D.com/store and search part number 55800719 or 55800721.



E. TALLBOY HANDLEBAR – 1.0"

*NOTE: Installation of some handlebars and risers may require a change in clutch and/or throttle cable and brake lines for some models. Handlebar height is regulated in many areas. Check local laws before installation.

Model Family Fitment:

 V-ROD	 SPORTSTER	 DYNA
 SOFTAIL	 TOURING	

Notice: The prices appearing in this catalog are the manufacturer's suggested retail prices. Actual retail prices may vary.

634 CONTROLS

Handlebars – Dyna®/Softail®/Sportster®

A. FAT DRAG HANDLEBAR*

Complete the transition to the dark side. The same shape as the Original Equipment polished handlebar on '08-'17 Fat Bob® models, this black drag bar places the hands in an aggressive but comfortable riding position and complements black finished hand controls and mirrors.

55977-09A Satin Black. **\$169.95**

Fits '18-later Softail® models (except FLDE), '13-'17 FXDB, '08-'17 FXDF, '10-'17 FXDWG, '10-'17 FLSTF and FLSTFB and '99-'15 FXST and FXSTB models. All models require separate purchase of additional components.

See your Dealer for cables, lines and additional installation components required, or visit www.H-D.com/store and search part number 55977-09A.

B. STREET SLAMMER BAR*

Comfort and attitude in one. This Street Slammer drag bar with 7.0" integrated risers offers a stylish alternative to separate curved risers, bar and handlebar clamp combinations and reduces the stretch required to reach traditional straight bars. This 1.25" fat bar is factory drilled to accept hidden control wires for a clean custom look. Available in brilliant chrome or satin black finish.

Fits '12-'16 FLD, '06-'17 FXDB, '08-'17 FXDF, '01-'05 FXDL, '16-'17 FXDLS, '99-'17 FXDWG, '00-'17 FLS, FLSS, FLSTC, FLSTF, FLSTFB, FLSTFBS, FLSTN, FXST, FXSTB, FXSTC and FXSTD, '18-later Softail (except FXBB, FXFB, FXFBS, FXBR and FXBRS). All models require separate purchase of additional installation components. Does not fit Road King® Models equipped with cruise control, '08 ABS-equipped models, Hydraulic Clutch Kits, Handlebar Mounted Gauges, Road Tech™ Radio, Softail Nacelle Kit Sidecar-equipped models.

55975-08A Chrome. **\$274.95**

55985-10 Satin Black. **\$274.95**

See your Dealer for cables, lines and additional installation components required, or visit www.H-D.com/store and search part number 55975-08A or 55985-10.

C. DRAG BAR*

Nothing says minimalist like a classically simple drag bar. Shaped to give the Nightster™ and Iron 883™ models an aggressive riding profile, this satin black 1.0" Drag Bar features 0" of rise and 4.0" of pull back to provide an excellent combination of forward positioning and wrist control.

55800035A Satin Black. **\$89.95**

Fits '07-later XL models with 2.2 or 3.3 gallon fuel tank. Does not fit XL883C, XL883R, XL1200C, XL1200L, XL1200R, XL1200T, '11-later XL883L or models equipped with 4.5 gallon large capacity fuel tank. All models require separate purchase of additional components.

Shown with:

HANDLEBAR RISER SPACER KIT

Required for installation of Clubman, Drag, Chizeled and Chizeled Lo Handlebars on Sportster XL1200X models, these gloss black spacers lift the bar and the gauge mount just enough to allow the bar to clear the upper fork nuts. You maintain the tight close to the triple tree look, and gain a stretched-out aggressive riding posture.

55900074 **\$59.95**

Fits '10-later XL1200X and XL1200XS models.

See your Dealer for cables, lines and additional installation components required, or visit www.H-D.com/store and search part number 55800035A.

*NOTE: Installation of some handlebars and risers may require a change in clutch and/or throttle cable and brake lines for some models. Handlebar height is regulated in many areas. Check local laws before installation.

Notice: The prices appearing in this catalog are the manufacturer's suggested retail prices. Actual retail prices may vary.



A. FAT DRAG HANDLEBAR – SATIN BLACK
(WIDE GLIDE SHOWN)



B. STREET SLAMMER BAR – CHROME
(ROAD KING SHOWN)



C. DRAG BAR – SATIN BLACK
(SHOWN ON XL1200X WITH RISER SPACER KIT)

CONTROLS 635

Handlebars – Dyna®/Softail®/Road King®



D. HOLLYWOOD HANDLEBAR*
(SPORTSTER FORTY-EIGHT SHOWN)



D. HOLLYWOOD HANDLEBAR*

Original Equipment on the Softail Slim® model, this traditional Hollywood-styled handlebar combines the laid-back riding attitude of the '40s with a shape that's perfect for today's new school stripped-down bobbers. With its limited rise, narrow profile and gentle pull back shape, this bar captures the look of a classic bar without the wide beach bar riding position.

55800579 Gloss Black. **\$109.95**
Fits '10-later XL1200X and XL1200XS, '06-'17 FXDB, '10-'17 FXDWG, '00-'17 FLSTC, FLSTF and FLSTFB, '08-'17 FLSTN, '18-later Softail® (except FXFB, FXFBS, FXBR and FXBRS) and '15-later FLRT models. Requires separate purchase of additional installation components.

See your Dealer for cables, lines and additional installation components required, or visit www.H-D.com/store and search part number 55800579.

E. BEACH HANDLEBAR*

This beefy 1.25" bar shows off your bike in style! This fat bar allows you to tuck the wires inside the bar for a clean, custom appearance and the highly-polished and chrome-plated bar will get you noticed. Installation requires separate purchase of additional components.

55967-08 Chrome. **\$204.95**
Fits '12-'16 FLD, '06-'07 and '13-'17 FXDB, '08-'17 FXDF, '01-'05 FXDL, '99-'17 FXDWG, '00-'17 FLS, FLSTC, FLSTF, FLSTFB, FLSTN, FXST, FXSTB, FXSTC and FXSTD and '03-'13 FLHR, FLHRC, FLHRS and '18-later Softail models (except FXFB and FXFBS). All models require separate purchase of additional installation components. Does not fit '08 ABS-equipped models, Hydraulic Clutch Kits, Handlebar Mounted Gauges, Softail Freight Train Nacelle Kit or Sidecar-equipped models.

See your Dealer for cables, lines and additional installation components required, or visit www.H-D.com/store and search part number 55967-08.

F. NARROW BEACH HANDLEBAR*

This beefy 1.25" handlebar sets the tone for a full-on custom ride. This chrome-plated fat bar combines the low rise and sweeping shape of a beach-style bar with a narrower tip-to-tip width for added rider comfort. Factory drilled to allow internal wiring for show-winning style.

56857-05A **\$199.95**
Fits '12-'16 FLD, '13-'17 FXDB, '00-'17 FLSTC, FLSTF, FLSTFB, FLSTFBS, FXST, FXSTB, FXSTC, FXSTD and '18-later Softail models. All models require separate purchase of Riser Kit P/N 56916-07 and additional installation components.

See your Dealer for cables, lines and additional installation components required, or visit www.H-D.com/store and search part number 56857-05A.



E. BEACH HANDLEBAR
(HERITAGE SOFTAIL CLASSIC SHOWN)



F. NARROW BEACH HANDLEBAR
(FAT BOY SHOWN)



*NOTE: Installation of some handlebars and risers may require a change in clutch and/or throttle cable and brake lines for some models. Handlebar height is regulated in many areas. Check local laws before installation.

Model Family Fitment:

- V-ROD
- SPORTSTER
- DYNA
- SOFTAIL
- TOURING

Notice: The prices appearing in this catalog are the manufacturer's suggested retail prices. Actual retail prices may vary.

636 CONTROLS

Handlebars – Sportster®/Dyna®

A. CHIZELED HANDLEBAR*

Achieve ultimate cutting edge style. The Chizeled Bar features the edgy profile of the classic Z bar and combines the hands-up feel of a mini-ape with the narrow width of a drag bar. The result? A classic chopper attitude. The 1.0" bar replaces mitered and welded corners with cast seamless 90° bends for added strength and style. The cast elbows eliminate sharp internal bends and the bar features removable Bar & Shield plugs to simplify internal wiring.

Fits '07-later XL883L, XL883N, XL1200L, XL1200N, XL1200NS, XL1200T, XL1200V, XL1200X and XL1200XS models. Also fits '06-'17 FXDB and '96-'05 FXDWG models with Original Equipment Handlebar P/N 58079-93. Does not fit with Heated Hand Grips. XL models require separate purchase of additional components.

55800198	Chrome.	\$299.95
55800103	Satin Black.	\$299.95

See your Dealer for cables, lines and additional installation components required, or visit www.H-D.com/store and search part number 55800198 or 55800103.



**A. CHIZELED HANDLEBAR – CHROME
(SPORTSTER SHOWN)**

B. CHIZELED LO HANDLEBAR*

With a low-profile 4.0" rise and a narrow lane-splitting 27" width, this compact Z-bar bar will give your bike a classic West Coast look. The 1.0" Chizeled Bar replaces mitered and welded corners with cast seamless 90° bends for added strength and style. The cast elbows eliminate sharp internal bends and the bar features removable Bar & Shield plugs to simplify internal wiring.

Fits '07-later XL883L, XL883N, XL1200CX, XL1200L, XL1200N, XL1200NS, XL1200T, XL1200V, XL1200X and XL1200XS models. Does not fit with Heated Hand Grips. All models require separate purchase of additional components.

55800430	Chrome.	\$309.95
55800431	Gloss Black.	\$309.95

See your Dealer for cables, lines and additional installation components required, or visit www.H-D.com/store and search part number 55800430 or 55800431.



**A. CHIZELED HANDLEBAR – SATIN BLACK
(STREET BOB SHOWN)**



B. CHIZELED LO HANDLEBAR

*NOTE: Installation of some handlebars and risers may require a change in clutch and/or throttle cable and brake lines for some models. Handlebar height is regulated in many areas. Check local laws before installation.

Notice: The prices appearing in this catalog are the manufacturer's suggested retail prices. Actual retail prices may vary.

CONTROLS 637

Handlebars – Dyna®/Softail®



C. FAT CHIZELED HANDLEBAR – CHROME
(SOFTAIL DELUXE SHOWN)

C. FAT CHIZELED HANDLEBAR*

Achieve ultimate cutting edge style. The Chizeled Bar features the edgy profile of the classic Z bar and combines the hands-up feel of a mini-ape with the narrow width of a drag bar. The result? A classic chopper attitude, and a comfortable hand and wrist position for tall riders. When installed with the stock riser, this 12" handlebar has the look and feel of a 14" version. The bar replaces mitered and welded corners with cast seamless 90° bends for added strength and style. The cast elbows eliminate sharp internal bends and the bar features removable Bar & Shield plugs to simplify internal wiring. The fat 1.25" bar necks down to fit stock 1.0" vehicle handlebar clamps.

Fits '12-'16 FLD, '13-'17 FXDB, '16-'17 FXDLS, and '00-'17 FLS, FLSS, FLSTC, FLSTF, FLSTFB, FLSTFBS, FLSTN, FXST, FXSTB, FXSTC and '18-later Softail® models (except FXBR, FXBRS, FXDRS, FXFB and FXFBS). All models require separate purchase of additional installation components.

55800421	Chrome.	\$379.95
55800422	Gloss Black.	\$379.95

See your Dealer for cables, lines and additional installation components required, or visit www.H-D.com/store and search part number 55800421 or 55800422.



C. FAT CHIZELED HANDLEBAR – GLOSS BLACK
(SOFTAIL SLIM SHOWN)

*NOTE: Installation of some handlebars and risers may require a change in clutch and/or throttle cable and brake lines for some models. Handlebar height is regulated in many areas. Check local laws before installation.

Model Family Fitment:

- V-ROD
- SPORTSTER
- DYNA
- SOFTAIL
- TOURING

Notice: The prices appearing in this catalog are the manufacturer's suggested retail prices. Actual retail prices may vary.

638 CONTROLS

Handlebars – Sportster®

A. SPORTSTER® REACH® HANDLEBAR*

This chrome handlebar is designed to bring the controls closer to the rider for increased comfort. Especially helpful for shorter riders or for riders that prefer a close-to-the-bar riding position.

56021-04B Chrome. **\$99.95**
Fits '04-'10 XL883C and '04-later XL1200C models.
Installation requires separate purchase of additional components.

See your Dealer for cables, lines and additional installation components required, or visit www.H-D.com/store and search part number 56021-04B.

B. SPORTSTER TALLBOY® HANDLEBAR*

Ergonomically designed and tested by a panel of riders from 5'11" to 6'4", this 1.0" Tallboy® handlebar enables long-armed riders to more comfortably fit and maneuver a compact Sportster® model. Shaped to provide the ideal balance of rise and width, this bar places the hands in a neutral position and stretches the arms to reduce the bend at the elbow.

Fits '07-later XL models. All models require separate purchase of additional installation components.

55800580 Chrome. **\$109.95**
55800587 Gloss Black. **\$109.95**

See your Dealer for cables, lines and additional installation components required, or visit www.H-D.com/store and search part number 55800580 or 55800587.

C. IRON 883™ HANDLEBAR*

Add an edgy touch to your Sportster model. Featuring the same shape, rise and pull back of the Iron 883™ Original Equipment stainless pull back handlebar, this satin black bar provides a choice in customizing style without the need to change cables and brake lines. Original Equipment on XL883N and XL1200X models.

55800345 Satin Black. **\$89.95**
Fits '10-later XL883L, XL1200C, XL1200NS, XL1200T, XL1200V and XL1200XS models. Installation requires separate purchase of additional components. Original Equipment on XL883N and XL1200X models.

See your Dealer for cables, lines and additional installation components required, or visit www.H-D.com/store and search part number 55800345.



A. SPORTSTER REACH HANDLEBAR



B. SPORTSTER TALLBOY HANDLEBAR



C. IRON 883 HANDLEBAR – SATIN BLACK

*NOTE: Installation of some handlebars and risers may require a change in clutch and/or throttle cable and brake lines for some models. Handlebar height is regulated in many areas. Check local laws before installation.

Notice: The prices appearing in this catalog are the manufacturer's suggested retail prices. Actual retail prices may vary.

CONTROLS 639

Handlebars – Sportster®/Dyna®/Softail®



D. MINI-APE HANDLEBAR – CHROME

D. MINI-APE HANDLEBAR*

Raise your fists to the wind. This 1.0" diameter Mini-Ape Handlebar features a conservative rise and bend for rider comfort and a chrome or satin black finish that complements the aggressive look of the Nightster™ and Street Bob® models.

Fits '07-later XL883L, XL883N, XL1200CX, XL1200L, XL1200N, XL1200NS, XL1200T, XL1200V, XL1200X and XL1200XS models. Also fits '06-'17 FXDB and '96-'05 FXDWG models with Original Equipment handlebar P/N 58079-93. XL models require separate purchase of additional components.

56079-93T	Chrome.	\$89.95
56075-07	Satin Black.	\$89.95

See your Dealer for cables, lines and additional installation components required, or visit www.H-D.com/store and search part number 56079-93T or 56075-07.

E. HERITAGE SOFTAIL® CLASSIC HANDLEBAR*

This chrome-plated bar is 1.25" narrower, 2.0" taller, and features 2.0" less pullback than the Original Equipment '09-'17 FLSTC Heritage Softail® Classic bar. This bar is also a direct replacement for the stainless steel handlebar P/N 56569-86 featured as Original Equipment on '86-'08 FLSTC models.

56623-99A	Chrome.	\$69.95
------------------	---------	----------------

Fits '86-'17 FLSTC models. '09-'17 FLSTC models require separate purchase of cables and brake lines.

See your Dealer for cables, lines and additional installation components required, or visit www.H-D.com/store and search part number 56623-99A.



E. HERITAGE SOFTAIL CLASSIC HANDLEBAR

F. FAT MINI-APE HANDLEBAR – FXSB SOFTAIL*

Give your ride a touch of old school style with this 1.25" Fat Ape Handlebar. The 12.0" high bar provides the look and attitude you dream about, but remains comfortable during long rides. This Mini-Ape Bar is factory drilled to accept internal wiring for a clean look.

55800252	Chrome.	\$419.95
-----------------	---------	-----------------

Fits '13-'17 FXSB models. Kit includes chrome-plated handlebar, riser and clamp with gauge mount. Separate purchase of additional components required.

See your Dealer for cables, lines and additional installation components required, or visit www.H-D.com/store and search part number 55800252 or 56943-10B.



F. FAT MINI-APE HANDLEBAR – FXSB SOFTAIL

*NOTE: Installation of some handlebars and risers may require a change in clutch and/or throttle cable and brake lines for some models. Handlebar height is regulated in many areas. Check local laws before installation.

Model Family Fitment:

 V-ROD	 SPORTSTER	 DYNA
 SOFTAIL	 TOURING	

Notice: The prices appearing in this catalog are the manufacturer's suggested retail prices. Actual retail prices may vary.

640 CONTROLS

Handlebars – Dyna®/Softail®/Road King®

NEW

A. 12" FAT MINI-APE HANDLEBAR*

This true 12" mid-rise Ape handlebar is the perfect mix of comfort and style. This bar features a traditional shape that tapers from a narrow base to a wide-open stance, and provides a flatter hand position with slightly less of the turned-in shape that can put stress on your wrists. The 1.25" diameter fat bar is factory drilled to allow internal wiring, and finished in your choice of show-quality chrome or gloss black surfaces. Handlebar can be installed in the Original Equipment risers on models factory-equipped with 1.25" handlebars.

Fits '14-later Road King® excluding vehicles equipped with 4-point H-D® detachable docking kits and '18-later FLFB, FLFBS, FLFB, FLFL, FXBB, FXBR, FXBRS, FXDRS, FXFB, FXFBS and FXLR models. Models originally equipped with 1.0" handlebar will require separate purchase of 1.25" handlebar riser kit. All models require separate purchase of additional installation components.

55800749	Chrome.	\$259.95
55800748	Gloss Black.	\$259.95

See your Dealer for cables, lines and additional installation components required, or visit www.H-D.com/store and search part number 55800479 or 55800748.

Shown with:

1.25" FAT RISER KIT – STREET® BOB AND BREAKOUT®

Required for installation of 1.25" handlebars on FXBB Street Bob® models, this curved riser kit features a one-piece top clamp that is shaped to accept the Original Equipment clamp-mounted digital gauge package. Kit includes two curved risers and one-piece clamp.

Fits '18-later FXBB, FXBR and FXBRS models.

55900157A	Gloss Black.	\$199.95
------------------	--------------	-----------------

B. 12" FAT MINI-APE HANDLEBAR KIT WITH RISER*

Big and beefy in the chopper tradition, this 1.25" Mini-Ape Handlebar is the perfect finish to an old school ride. Factory drilled to allow internal wiring, the show-quality chrome or black finish reflects your attention to custom details. This 12.0" high bar and riser combination provides the look and attitude you dream about, but remains comfortable over the long haul. Handlebar kit includes matching riser and custom handlebar clamp that conceals the wire exit for a clean look.

Fits '12-'16 FLD, '06-'17 FXDB, '08-'17 FXDF, '16-'17 FXDLS, '99-'17 FXDWG, '00-'17 FLS, FLSS, FLSTC, FLSTF, FLSTFB, FLSTFBS, FLSTN, FXCW, FXCWC, FXST, FXSTB, FXSTC, '18-later Softail® (except FXBB, FXBR, FXBRS, FXFB and FXFBS). All models require separate purchase of additional installation components. Does not fit with Hydraulic Clutch Kits, handlebar-mounted gauges, or Softail Freight Train Nacelle Kit. Satin Black kit features gloss black risers.

56832-04C	Chrome.	\$309.95
55859-10B	Black.	\$309.95

See your Dealer for cables, lines and additional installation components required, or visit www.H-D.com/store and search part number 56832-04C or 55859-10B.

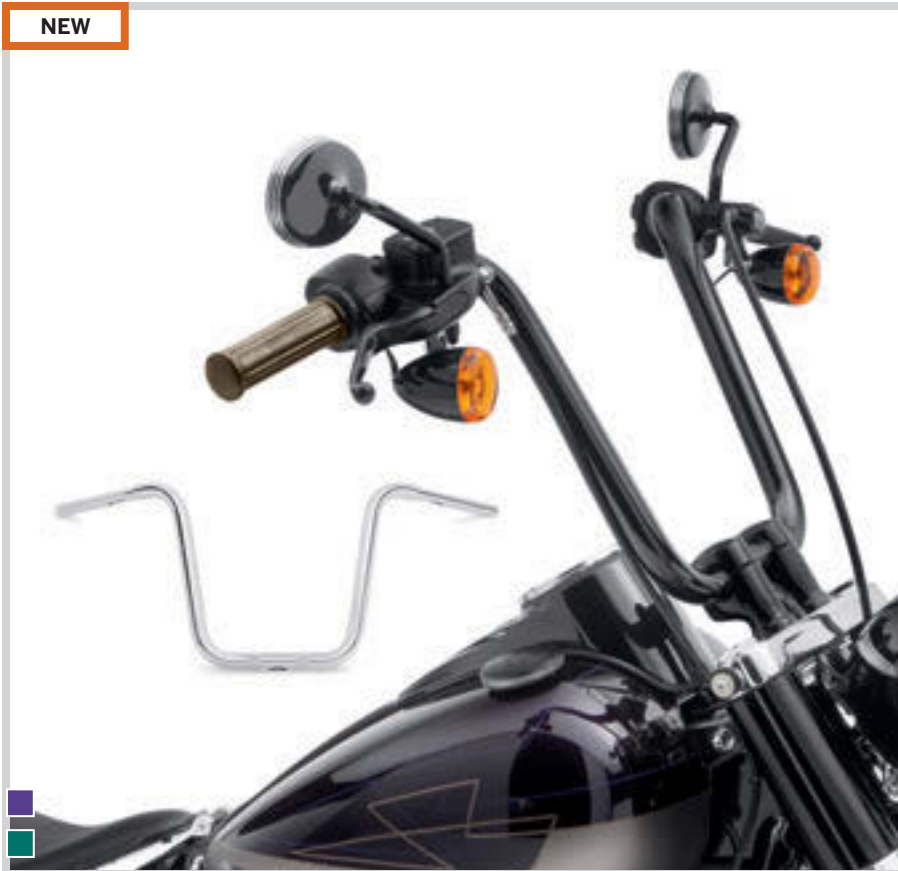

A. 12" FAT MINI-APE HANDLEBAR



B. 12" FAT MINI-APE HANDLEBAR KIT WITH RISER – CHROME

*NOTE: Installation of some handlebars and risers may require a change in clutch and/or throttle cable and brake lines for some models. Handlebar height is regulated in many areas. Check local laws before installation.

Model Family Fitment:

 V-ROD	 SPORTSTER	 DYNA
 SOFTAIL	 TOURING	

Notice: The prices appearing in this catalog are the manufacturer's suggested retail prices. Actual retail prices may vary.

CONTROLS 641

NEW

Handlebars – Dyna®/Softail®/Road King®

CONTROLS



C. 16" FAT APE HANDLEBAR

C. 16" FAT APE HANDLEBAR*

This beefy 16" Fat Ape handlebar is shaped to give even the tallest rider the hands in the air riding position. The bar features a flatter hand position that positions your wrists in a neutral position for long ride comfort. This true-height 16" bar can be installed in the Original Equipment risers on models factory-equipped with 1.25" handlebars, and the bar is pre-drilled to allow internal wiring. Available in your choice of chrome or gloss black finish, these bars are ready to deliver your custom attitude.

Fits '14-later Road King® excluding vehicles equipped with 4-point H-D® detachable docking kits and '18-later FLFB, FLFBS, FLFB, FLSL, FXBB, FXBR, FXBRS, FXDRS, FXFB, FXFBS and FXLR models. Models originally equipped with 1.0" handlebar will require separate purchase of 1.25" handlebar riser kit. All models require separate purchase of additional installation components.

55800750	Chrome.	\$279.95
55800751	Gloss Black.	\$279.95

D. 16" FAT APE HANDLEBAR KIT WITH RISER*

Reach for the sky. This brawny 1.25" Ape Handlebar is the ideal choice for the long-armed rider or anyone looking for that classic fists in the wind riding profile. Factory drilled to allow internal wiring, the show-quality chrome or satin-black finish complements your bike's overall design sense. This 16.0" high bar and riser combination provides the look you crave around town and the bar can be rotated in the clamp and locked down to place your hands in your ideal open-road riding position. Handlebar kit includes matching riser and custom handlebar clamp that conceals the wire exit for a clean look.

Fits '12-'16 FLD, '06-'17 FXDB, '08-'17 FXDF, '16-'17 FXDLS, '99-'17 FXDWG, '00-'17 FLS, FLSS, FLSTC, FLSTF, FLSTFB, FLSTFBS, FLSTN, FXCW, FXCWC, FXST, FXSTB and FXSTC, '18-later FLFB, FLFBS, FLFB, FLSL and FXLR models. All models require separate purchase of additional installation components. Does not fit with Hydraulic Clutch Kits, handlebar-mounted gauges, or Softail® Freight Train Nacelle Kit. Satin Black kit features gloss black risers.

56942-10B	Chrome.	\$329.95
55857-10B	Satin Black.	\$329.95

See your Dealer for cables, lines and additional installation components required, or visit www.H-D.com/store and search part number 56942-10B or 55857-10B.



D. 16" FAT APE HANDLEBAR KIT WITH RISER – SATIN BLACK

*NOTE: Installation of some handlebars and risers may require a change in clutch and/or throttle cable and brake lines for some models. Handlebar height is regulated in many areas. Check local laws before installation.

Notice: The prices appearing in this catalog are the manufacturer's suggested retail prices. Actual retail prices may vary.

642 CONTROLS

Handlebars – Road King®

A. ROAD KING® FAT HANDLEBAR*

Similar to Original Equipment handlebar on the '14 CVO™ Road King® model, this beefy 1.25" handlebar places the rider in a laid-back riding posture. This handlebar provides 2.0" of additional pull back and a 1.0" lower hand position than the Original Equipment Road King bar. The 1.25" diameter bar allows you to tuck the wires inside the bar for a clean, custom look.

55800386 Chrome. **\$259.95**

Fits '14-later Road King models (except FLHRXS). All models require separate purchase of additional components for installation.

See your Dealer for cables, lines and additional installation components required, or visit www.H-D.com/store and search part number 55800386.

B. ROAD KING/ROAD GLIDE® HERITAGE STYLE HANDLEBAR*

Designed to provide extra touring comfort for the Road King or Road Glide® rider, this 1.0" diameter stainless steel bar has 3.0" more pull back compared to the stock '08-'13 Road King handlebar. Heritage Bar has the same dimensions as the '14-later Road King Original Equipment bar.

Fits '14-later Road King (except FLHRXS) and '08-'13 FLTR models. All models require separate purchase of additional components for installation.

55864-09 Satin Black. **\$99.95**

56902-08 Polished Stainless Steel. **\$99.95**

See your Dealer for cables, lines and additional installation components required, or visit www.H-D.com/store and search part number 55684-09 or 56902-08.



A. ROAD KING FAT HANDLEBAR – CHROME



B. ROAD KING/ROAD GLIDE HERITAGE STYLE HANDLEBAR

*NOTE: Installation of some handlebars and risers may require a change in clutch and/or throttle cable and brake lines for some models. Handlebar height is regulated in many areas. Check local laws before installation.

Model Family Fitment:

■ V-ROD ■ SPORTSTER ■ DYNA
■ SOFTAIL ■ TOURING

Notice: The prices appearing in this catalog are the manufacturer's suggested retail prices. Actual retail prices may vary.

CONTROLS 643

Handlebars – Road King®/Road Glide®

C. ROAD KING®/ROAD GLIDE® REACH® HANDLEBAR*

This 1.0" diameter chrome bar has 2.0" more pull back compared to the stock Road King® handlebar. Accepts internal wiring for a clean look. The neutral hand position is comfortable for the long haul and the narrow width and pull back design produces a major ergonomic change.

56166-08 Chrome. **\$104.95**

Fits '08-later FLHR and FLHRC (except FLHRXS), '08-'13 FLTR, FLTRU and FLTRX models. Does not fit '08 ABS equipped models, Sidecar-equipped models or Handlebar Mounted Gauges. All models require separate purchase of additional components for installation.

See your Dealer for cables, lines and additional installation components required, or visit www.H-D.com/store and search part number 56166-08.

D. ROAD KING®/ROAD GLIDE®/FREEWHEELER® TALLBOY® HANDLEBAR*

Designed to provide extra touring comfort for the Road King rider, this 1.0" diameter chrome bar is 2.0" higher and 1.5" narrower compared to the stock Road King handlebar.

56180-08 Chrome. **\$99.95**

Fits '08-later FLHR and FLHRC (except FLHRXS), '08-'13 FLTR, and '15-later FLRT models. Does not fit '08 ABS equipped models, Sidecar-equipped models or Handlebar Mounted Gauges. All models require separate purchase of additional components for installation.

See your Dealer for cables, lines and additional installation components required, or visit www.H-D.com/store and search part number 56180-08.

Also available: (not shown)

ROAD KING®/ROAD GLIDE® TALLBOY HANDLEBAR* – '96-'07 MODELS

Designed to provide extra comfort for the Road King rider, this chrome bar is 4.5" higher and 2.0" narrower than the stock handlebar found on '96-'99 Road King models and 3.5" higher and 1.5" narrower than stock handlebar on '00-'01 Road King models. Many models require no additional cables or hoses for installation.

55954-00 Chrome. **\$99.95**

Fits '96-'07 Road King and '02-'07 Road Glide® models. Does not fit CVO™ models with 1.25" handlebars.

See your Dealer for cables, lines and additional installation components required, or visit www.H-D.com/store and search part number 55954-00.



C. ROAD KING®/ROAD GLIDE® REACH® HANDLEBAR



D. ROAD KING®/ROAD GLIDE® TALLBOY HANDLEBAR

*NOTE: Installation of some handlebars and risers may require a change in clutch and/or throttle cable and brake lines for some models. Handlebar height is regulated in many areas. Check local laws before installation.

Notice: The prices appearing in this catalog are the manufacturer's suggested retail prices. Actual retail prices may vary.

644 CONTROLS

Handlebars – Batwing

CHOOSE YOUR BATWING HANDLEBAR

Just about every model of Harley-Davidson® motorcycle features a different stock handlebar. Selected to complement the style or use of the bike, the handlebar may be the ideal shape for many riders, but of course, not everyone has the same physical characteristics.

Choosing a bar for your batwing fairing-equipped model is about more than just style – it's about how you approach the road. Where the bar positions your hands, wrists, and arms directly affects how you feel on your motorcycle. For every set of bars, there are three factors at work: rise, pullback and width. These three measurements determine your reach to the hand controls and, therefore your overall feeling of comfort and control.

A. ELECTRA GLIDE® CHROME HANDLEBAR*

Replace your stock polished bar with this 1.0", chrome handlebar that allows you to tuck the wires inside the bar for a clean, finished look. Identical shape to the Original Equipment Electra Glide and Street Glide bar, this high-quality chrome-plated handlebar is designed to be compatible for use with TGS-equipped Electra Glide® models.

56036-08 Chrome. **\$154.95**
Fits '09-later Electra Glide and Street Glide® models (except FLHXS and CVO™ models). Does not fit Trike models. All models require separate purchase of additional components.

See your Dealer for cables, lines and additional installation components required, or visit www.H-D.com/store and search part number 56036-08.



BATWING STOCK HANDLEBAR



BATWING REACH HANDLEBAR



BATWING CHIZELED HANDLEBAR



BATWING MINI APE HANDLEBAR



A. ELECTRA GLIDE CHROME HANDLEBAR

*NOTE: Installation of some handlebars and risers may require a change in clutch and/or throttle cable and brake lines for some models. Handlebar height is regulated in many areas. Check local laws before installation.

Model Family Fitment:

- V-ROD
- SPORTSTER
- DYNA
- SOFTAIL
- TOURING

Notice: The prices appearing in this catalog are the manufacturer's suggested retail prices. Actual retail prices may vary.

CONTROLS 645

Handlebars – Batwing



B. BATWING REACH HANDLEBAR

B. BATWING REACH® HANDLEBAR*

The Batwing Reach® Handlebar is shaped to provide all-day riding comfort for smaller stature riders. Extensively tested by a panel of riders that stand 5'-1" to 5'-5" tall, the Reach Handlebar was ergonomically designed to provide the ideal combination of shoulder position, elbow bend and wrist angle. The bar brings the grips closer to the rider, and features a narrower width, lower height and flatter hand position. The narrow profile also brings the hands in toward the center of the vehicle for easier maneuvering.

Combining a Reach Seat with a Reach Handlebar provides a smaller stature rider with an optimized rider triangle and a complete fit solution.

Fits '09-later Electra Glide®, Street Glide®, Ultra Limited (except '10-'13 FLHTK) and '09-later Trike models (except Freewheeler®). Also fits '17-later FLHTKSE and FLHXSE models. All models require separate purchase of additional components. Street Glide models and models with fairing-mount mirrors require separate purchase of handlebar-mounted mirrors and Fairing Plugs.

55800589	Chrome.	\$159.95
55800590	Gloss Black.	\$159.95

See your Dealer for cables, lines and additional installation components required, or visit www.H-D.com/store and search part number 55800589 or 55800590.

Also available: (not shown)

BATWING REACH HANDLEBAR*

These high-quality, handlebars are designed to bring the controls 2.0" closer to the rider for increased comfort. Especially helpful for shorter riders or those with short arms.

55914-98	Polished Stainless Steel.	\$154.95
-----------------	---------------------------	-----------------

Fits '02-'07 Electra Glide and Street Glide models. All models require separate purchase of additional components. '08-'13 FLHX and models with fairing-mount mirrors require separate purchase of handlebar-mounted mirrors and Fairing Plugs P/N 732 (Qty 2) and 755 (Qty 2). Does not fit models equipped with Hydraulic Clutch Kits or Sidecar.

See your Dealer for cables, lines and additional installation components required, or visit www.H-D.com/store and search part number 55914-98.

C. BATWING TALLBOY® HANDLEBAR*

The Batwing Tallboy® Handlebar is shaped to provide a tall rider with the ideal combination of shoulder, elbow and wrist positions for a long day in the saddle. The Tallboy handlebar was extensively tested by a panel of riders between 5'-11" and 6'-3" tall, resulting in a higher and flatter hand location. The bar also stretches the elbow to a natural angle, and reduces the cramped look often seen in riders with long arms.

Combining a Tallboy Seat with a Tallboy Handlebar provides the rider with an optimized rider triangle and a complete fit solution.

Fits '09-later Electra Glide, Street Glide, Ultra Limited (except '10-'13 FLHTK) and '09-later Trike models (except Freewheeler). Does not fit CVO™ models. All models require separate purchase of additional components. Street Glide models and models with fairing-mount mirrors require separate purchase of handlebar-mounted mirrors and Fairing Plugs.

55800591	Chrome.	\$159.95
55800592	Gloss Black.	\$159.95

See your Dealer for cables, lines and additional installation components required, or visit www.H-D.com/store and search part number 55800591 or 55800592.



C. BATWING TALLBOY HANDLEBAR

*NOTE: Installation of some handlebars and risers may require a change in clutch and/or throttle cable and brake lines for some models. Handlebar height is regulated in many areas. Check local laws before installation.

Notice: The prices appearing in this catalog are the manufacturer's suggested retail prices. Actual retail prices may vary.

646 CONTROLS

Handlebars – Batwing

A. BATWING MINI-APE HANDLEBAR*

Throw your fists in the air with these 12.0" ape hangers. A favorite among long-armed riders, these bars are shaped to rest your hands just above the top of the classic batwing fairing. The bars feature a tall stance and minimal amount of pull back that help to achieve a cool yet comfortable riding profile. Finished in brilliant chrome or satin black, these 1.0" handlebars accept internal wiring for a clean look.

Fits '09-later Electra Glide®, Street Glide®, Ultra Limited (except '10-'13 FLHTK) and Trike (except FLRT) models. Does not fit CVO™ models. All models require separate purchase of additional components for installation. '09-'13 FLHX and models with fairing-mount mirrors require separate purchase of handlebar-mounted mirrors and Fairing Plugs.

57474-11	Chrome.	\$194.95
57485-11	Satin Black.	\$194.95

See your Dealer for cables, lines and additional installation components required, or visit www.H-D.com/store and search part number 57474-11 or 57485-11.

B. BATWING CHIZELED HANDLEBAR*

Bring cutting edge style to your custom bagger. The Batwing Chizeled Bar combines the rise of a 12" mini-ape with the edgy profile of the classic Z bar and the wrist position of a drag bar. The result? An aggressive hands-in-the-air riding posture. The fat 1.25" bar replaces mitered and welded corners with cast seamless 90° bends for added strength and style. The cast elbows eliminate sharp internal bends to simplify internal wiring. The bar slims down to 1.0" at the base to fit with Original Equipment handlebar clamps.

Fits '14-later Electra Glide, Street Glide, Ultra Limited and Tri Glide® models. All models require separate purchase of additional components for installation. Street Glide models and models with fairing-mounted mirrors require separate purchase of handlebar-mounted mirrors and fairing plugs. Does not fit with Heated Hand Grips. Does not fit CVO models.

55800298	Chrome.	\$379.95
55800299	Gloss Black.	\$379.95

See your Dealer for cables, lines and additional installation components required, or visit www.H-D.com/store and search part number 55800298 or 55800299.



A. BATWING MINI-APE HANDLEBAR



B. BATWING CHIZELED HANDLEBAR

*NOTE: Installation of some handlebars and risers may require a change in clutch and/or throttle cable and brake lines for some models. Handlebar height is regulated in many areas. Check local laws before installation.

Notice: The prices appearing in this catalog are the manufacturer's suggested retail prices. Actual retail prices may vary.

CONTROLS 647

Handlebars – Road Glide®

CHOOSE YOUR ROAD GLIDE® HANDLEBAR

Just about every model of Harley-Davidson® motorcycle features a different stock handlebar. Selected to complement the style or use of the bike, the handlebar may be the ideal shape for many riders, but of course, not everyone has the same physical characteristics.

Choosing a bar for your Road Glide® model is about more than just style – it's about how you approach the road. Where the bar positions your hands, wrists, and arms directly affects how you feel on your motorcycle. For every set of bars, there are three factors at work: rise, pullback and width. These three measurements determine your reach to the hand controls and, therefore your overall feeling of comfort and control.

C. ROAD GLIDE TALLBOY® HANDLEBAR*

This 1.25" diameter bar features an optimized ergonomic design for taller and long-limbed riders. The bar is 2" taller than the Original Equipment handlebar, and is sized to accept internal wiring for a clean look.

Fits '15-later FLTRX, FLTRXS and FLTRU models. All models require separate purchase of additional components. Does not fit CVO™ models.

55800550A	Chrome.	\$279.95
55800551A	Satin Black.	\$279.95

See your Dealer for cables, lines and additional installation components required, or visit www.H-D.com/store and search part number 55800550A or 55800551A.

D. ROAD GLIDE FAT APE HANDLEBAR*

Hang'em high. Across town or cross country, this classic-shaped Fat Ape Handlebar adds a touch of old school style to your modern urban bagger. Designed for Road Glide models, this beefy 1.25" bar features 15" of rise and a shape that provides a cool yet comfortable riding profile. Available in your choice of finish, this fat bar accepts internal wiring for a show-quality look that's built for the open road.

Fits '15-later FLTRX, FLTRXS and FLTRU models. All models require separate purchase of additional components. Does not fit CVO models.

55800548A	Chrome.	\$289.95
55800549A	Satin Black.	\$289.95

See your Dealer for cables, lines and additional installation components required, or visit www.H-D.com/store and search part number 55800548A or 55800549A.



C. ROAD GLIDE TALLBOY HANDLEBAR



D. ROAD GLIDE FAT APE HANDLEBAR – SATIN BLACK

*NOTE: Installation of some handlebars and risers may require a change in clutch and/or throttle cable and brake lines for some models. Handlebar height is regulated in many areas. Check local laws before installation.

Model Family Fitment:

 V-ROD	 SPORTSTER	 DYNA
 SOFTAIL	 TOURING	

Notice: The prices appearing in this catalog are the manufacturer's suggested retail prices. Actual retail prices may vary.

648 CONTROLS

Handlebars – Road Glide®

A. ROAD GLIDE® CHIZELED LO HANDLEBAR*

With a low 9.0" rise and a flat drag-bar hand position, this compact Z bar will place the rider into an aggressive, tucked-in riding posture. Many Road Glide® motorcycle riders feel this is our most comfortable handlebar, with optimal wrist position and elbow bend. The 1.25" Chizeled Bar replaces mitered and welded corners with cast seamless 90° bends for added strength and style. The cast elbows eliminate sharp internal bends and the bar features removable Bar & Shield plugs to simplify internal wiring. Bars are available in brilliant chrome or gloss black finishes to match your bike's custom direction.

Fits '15-later FLTRX and FLTRXS models. Does not fit '18-later FLTRXSE or models equipped with 21" Knockout Wheel Kit P/N 43300494 or 43300496. All models require separate purchase of additional components. Does not fit CVO™ models.

55800568	Chrome.	\$349.95
55800569	Gloss Black.	\$349.95

See your Dealer for cables, lines and additional installation components required, or visit www.H-D.com/store and search part number 55800568 or 55800569.

B. ROAD GLIDE CHIZELED HANDLEBAR*

Bring cutting edge style to your custom bagger. The Road Glide Chizeled Bar combines the rise of a 14" mini-ape with the edgy profile of the classic Z bar and the wrist position of a drag bar. The result? An aggressive hands-in-the-air riding posture. The fat 1.25" bar replaces mitered and welded corners with cast seamless 90° bends for added strength and style. The cast elbows eliminate sharp internal bends and the bar features removable Bar & Shield plugs to simplify internal wiring.

Fits '15-later FLTRX, FLTRXS and FLTRU models. Does not fit '18-later FLTRXSE or models equipped with 21" Knockout Wheel Kit P/N 43300494 or 43300496. All models require separate purchase of additional components. Does not fit CVO models.

55800439	Chrome.	\$379.95
55800440	Gloss Black.	\$379.95

See your Dealer for cables, lines and additional installation components required, or visit www.H-D.com/store and search part number 55800439 or 55800440.



A. ROAD GLIDE CHIZELED LO HANDLEBAR



B. ROAD GLIDE CHIZELED HANDLEBAR

*NOTE: Installation of some handlebars and risers may require a change in clutch and/or throttle cable and brake lines for some models. Handlebar height is regulated in many areas. Check local laws before installation.

Model Family Fitment:

 V-ROD	 SPORTSTER	 DYNA
 SOFTAIL	 TOURING	

Notice: The prices appearing in this catalog are the manufacturer's suggested retail prices. Actual retail prices may vary.

HANDLEBAR RISERS

You may think you are perfectly happy with the way your bike is adjusted. But that doesn't mean that it is correctly set up for you. We get used to our bikes – our muscles become trained and we end up accommodating the bike. It is far better to take the time to make the bike accommodate you. If you are satisfied with your handlebar's width and wrist position, but wish it was just a little higher, lower or closer to you, your dealer can recommend a set of handlebar risers that move the bar into your comfort zone.

ADJUSTING YOUR HAND POSITION



STOCK HANDLEBAR

Just about every model of Harley-Davidson® motorcycle comes with a different stock handlebar. Selected to complement the style of the bike, the handlebar may be the ideal shape for many riders, but of course, not everyone has the same physical characteristics.



STOCK HANDLEBAR WITH RISERS

If the stock handlebar has the correct width and hand position for you, but seems just a little too far away, we offer riser kits that bring the controls within reach. Straight and curved risers are available for many model and handlebar combinations.

ORIGINAL EQUIPMENT RISER DIMENSIONS

DESCRIPTION	BAR DIAMETER (IN)	HEIGHT (IN)	PULL BACK (IN)	FINISH
Road King®, Batwing Touring & Trike	1.00	1.70	0.00	Cast Alum
Road Glide®	1.25	1.70	0.00	Cast Alum
Softail® – FLSTC, FLS & FLSS	1.00	1.94	0.39	Chrome/Black
Softail – FLSTF, FLSTFB & FLSTFBS	1.25	2.40	0.87	Chrome/Black
Softail – FLSTN	1.00	4.45	1.30	Chrome
Softail – FXSB	1.25	4.00	1.15	Chrome
Dyna® – FLD	1.00	3.10	1.18	Chrome
Dyna – FXDB	1.00	1.00	n/a	Polished Alum
Dyna – FXDL	1.00	4.39	1.61	Polished Alum
Dyna – FXDF & FXDWG	1.25	5.00	0.60	Black, Gloss
XL – 1200C	1.00	4.73	1.13	Chrome
XL – 883N	1.00	2.07	0.00	Black, Wrinkle
XL – 883L & 1200T	1.00	2.07	0.00	Black
XL – 1200L, 1200CP & 1200V	1.00	1.86	0.00	Chrome
XL – 1200CX	1.00	1.21	0.00	Black
XL – 1200X	1.00	0.94	n/a	Black, Gloss
VRSC™ – VRSCD & VRSCDX	1.00	2.68	0.40	Black

ACCESSORY RISER DIMENSIONS*

KIT P/N	DESCRIPTION	BAR DIAMETER (IN)	HEIGHT (IN)	PULL BACK (IN)	FINISH
55996-09	Black Fat Risers	1.25	5.0	0.6	Black, Gloss
56269-09	Curved Pull Back, 4.0"	1.25	4.0	1.3	Chrome
56267-09	Curved Pull Back, 6.0"	1.25	6.0	1.7	Chrome
56066-82A	Curved Riser, 4.0"	1.00	4.4	1.5	Chrome
56266-09	Curved Riser, 6.0"	1.00	6.0	1.7	Chrome
55900023	Deluxe Pull Back Riser	1.00	4.4	0.8	Chrome
55900122	Fat Riser	1.25	1.0	0.0	Chrome
55900123	Fat Riser	1.25	1.0	0.0	Black, Gloss
55900165	Slim Pull Back Riser	1.00	4.5	1.5	Black, Gloss
55900166	Clamp and Riser Kit	1.00	1.0	0.0	Black, Gloss
56929-10	Fat One-Piece Riser, Chrome	1.25	4.1	0.0	Chrome
56916-07	Fat-Bar Risers	1.25	3.6	0.0	Chrome
46809-09	Riser Kit for Nacelle	1.00	1.9	0.0	Chrome
56063-82A	Straight Riser, 4.0"	1.00	4.0	0.0	Chrome

*NOTE: Installation of some handlebars and risers may require a change in clutch and/or throttle cable and brake hose for some models. Handlebar height is regulated in many areas. Check local laws before installation.

650 CONTROLS

Handlebar Risers

A. FAT HANDLEBAR RISER KIT*

Designed to enable the installation of a 1.25" handlebar on models originally equipped with a 1.0" bar, these low profile risers feature a one-piece top clamp for added support and style. Available in mirror chrome or gloss black finish, these kits include matching installation hardware.

Fits '18-later FLDE, FLFB, FLFBS, FLHC, FLHCS, FLSB, FLFL, FXDRS and FXLR models.

55900122	Chrome.	\$139.95
55900123	Gloss Black.	\$139.95

B. HANDLEBAR CLAMP & RISER KIT – GLOSS BLACK

Go for a total blackout. Replace your Original Equipment Riser. Includes all necessary mounting hardware.

55900166		\$179.95
Fits '18-later Softail® models (except FXBB, FXBR and FXBRS) equipped with 1" handlebars.		

C. FAT RISER KIT – CHROME*

This riser features a one-piece base that is designed for use with internally-wired 1.25" handlebars and provides a skirt that conceals the wiring's exit from the bar. The matching handlebar clamp ties it all together. Available in mirror chrome finish, the kit includes riser, matching handlebar clamp and clamp hardware.

56929-10		\$139.95
Fits most 1.25" diameter handlebars. Does not fit FXSB, FXSBSE, FXBB, FXBR, FXBRS and Springer™ models. Requires separate purchase of additional components. See your dealer for details. Riser height 4.1".		

D. FAT BAR RISER KIT – CHROME*

Go phat with bold chrome-plated risers. Hidden fasteners create a clean, seamless look. Kit includes all necessary mounting hardware.

56916-07		\$134.95
Fits most 1.25" diameter handlebars. Does not fit FXSB, FXSBSE, FXBB, FXBR, FXBRS and Springer models. Requires separate purchase of additional components. See your dealer for details. Riser height 3.6".		

E. FAT HANDLEBAR RISER KIT – BLACK*

Add a splash of darkness to your front end with these blacked out risers. First introduced on the FXDF model, these risers feature a gloss black finish that will look good with any black or chrome bar.

55996-09		\$144.95
Fits most 1.25" diameter handlebars. Does not fit FXSB, FXSBSE, FXBB, FXBR, FXBRS and Springer models. Requires separate purchase of additional components. See your dealer for details. Riser height 5.0".		

F. CURVED PULL BACK FAT RISERS – CHROME*

These chrome-plated Curved Pull Back Risers provide a comfortable riding position for those who like the shape, width and hand position of their current handlebar, but wish it was closer. For an ergonomically-friendly ride, these risers can be combined with a Harley-Davidson® Reach® Seat and Profile® Low suspension components to reduce arm stretch and to plant the feet firmly on the ground.

Fits most 1.25" diameter handlebars. Does not fit FXSB, FXSBSE, FXBB, FXBR, FXBRS and Springer models. Requires separate purchase of additional components. See your dealer for details.

56269-09	4" Curved Riser.	\$184.95
56267-09	6" Curved Riser.	\$189.95

*NOTE: Installation of some handlebars and risers may require a change in clutch and/or throttle cable and brake lines for some models. Handlebar height is regulated in many areas. Check local laws before installation.

Notice: The prices appearing in this catalog are the manufacturer's suggested retail prices. Actual retail prices may vary.



A. FAT HANDLEBAR RISER KIT – CHROME



A. FAT HANDLEBAR RISER KIT – GLOSS BLACK



B. HANDLEBAR CLAMP & RISER KIT – GLOSS BLACK



C. FAT RISER KIT – CHROME



D. FAT BAR RISER KIT – CHROME



E. FAT HANDLEBAR RISER KIT – BLACK



F. CURVED PULL BACK FAT RISERS – 4" CHROME



F. CURVED PULL BACK FAT RISERS – 6" CHROME

CONTROLS 651

Handlebar Risers



G. SOFTTAIL SLIM PULL BACK RISER KIT – CHROME

G. SOFTTAIL SLIM® PULL BACK RISER KIT*

Ideal for riders with a short reach or for those that prefer an upright riding position, these curved risers and the matching handlebar clamp are shaped to put the Original Equipment Softail Slim® handlebar closer to the rider. Designed for easy installation, these 4.5" high risers are compatible with the stock control cables for a low-cost conversion. Provides 1.75" of rise and 1.5" of additional pull back when compared to the stock FLS riser.

Fits most '12-'17 FLS and FLSS and '18-later FLSL models with no additional components. '15-'17 FLS and FLSS models equipped with ABS brakes require separate purchase of Brake Line P/N 41800300. Also fits most 1.0" diameter handlebars with separate purchase of additional components. Does not fit Springer™ models. Riser height 4.5".

55900165	Gloss Black.	\$179.95
55900023	Chrome.	\$179.95



G. SOFTTAIL SLIM PULL BACK RISER KIT – GLOSS BLACK

H. HANDLEBAR RISER KITS – CHROME*

These chrome-plated risers provide a comfortable riding position for those who like the shape, width and hand position of their current 1.0" handlebar, but wish it was closer. For an ergonomically-friendly ride, these risers can be combined with a Harley-Davidson® Reach® forward-position seat and Profile® Low suspension components to reduce arm stretch and to plant the feet firmly on the ground. Finish off the look with a Harley-Davidson decorative handlebar clamp kit.

Fits most 1.0" handlebars. Does not fit FXBB, FXBR, FXBRS and Springer models. Installation may require separate purchase of handlebar clamp. See your dealer for details. Installation also may affect fitment of handlebar-mounted instruments.

56066-82A	4.0" Curved Risers.	\$144.95
56063-82A	4.0" Straight Risers.	\$144.95
56266-09	6.0" Curved Risers.	\$149.95

I. BILLET HANDLEBAR RISER HARDWARE – CHROME

Provides a highly polished and plated, machined steel, conical shaped washer. Chrome socket head cap screw is countersunk into the washer upon installation for a very clean look. Screws are also chrome-plated. Looks great with Original Equipment or billet triple trees.

63026-05		\$49.95
Fits '91-'17 Dyna® (except '08-'17 FXDB and FXDF) and '97-'17 FXSB, FXST, FXSTB, FXSTC and FXSTD models. Also fits '93-'00 FXR models.		

J. POLYURETHANE HANDLEBAR RISER BUSHINGS

These Handlebar Riser Bushings replace the Original Equipment stacked rubber and zinc washer combination with a long-lasting polyurethane bushing and cover. These firm bushings provide a direct link between the bar and the front fork for a solid feel - and they reduce the softness you experience when a tall or wide handlebar is installed in Original Equipment vibration-isolating rubber mounts.

56298-03A		\$49.95
Fits '83-later Touring models. Kit includes replacement riser bolts. Does not fit Trike models.		

56165-03		\$44.95
Fits '97-'03 XL, '86-'17 Dyna (except FXDB and '14-'17 FXDL) and '86-'17 Softail® (except Springer models, FXS and FXSTD) models. '86-'93 FL Softail models require use of '94-later Riser Bolts. Will not fit with Chrome Riser Cup Washer Kit P/N 56486-01.		



H. HANDLEBAR RISER KIT – CHROME STRAIGHT

H. HANDLEBAR RISER KIT – CHROME CURVED



I. BILLET HANDLEBAR RISER HARDWARE – CHROME

J. POLYURETHANE HANDLEBAR RISER BUSHINGS

*NOTE: Installation of some handlebars and risers may require a change in clutch and/or throttle cable and brake lines for some models. Handlebar height is regulated in many areas. Check local laws before installation.

Model Family Fitment:

■ V-ROD	■ SPORTSTER	■ DYNA
■ SOFTAIL	■ TOURING	

Notice: The prices appearing in this catalog are the manufacturer's suggested retail prices. Actual retail prices may vary.

652 CONTROLS

Handlebar Risers

A. RISER CUP WASHER KIT – CHROME

Add a finishing touch to the riser on your bike. This kit includes two styled and chrome-plated washers that replace the standard metal washers below the handlebar risers. Replaces Original Equipment P/N 56159-73.

56486-01 **\$24.95**

Fits '97-'03 XL, '86-'17 Dyna® (except FXDB) and Softail® models (except Springer™, FXS and FXSTD). Does not fit with Polyurethane Handlebar Bushings P/N 56165-03.

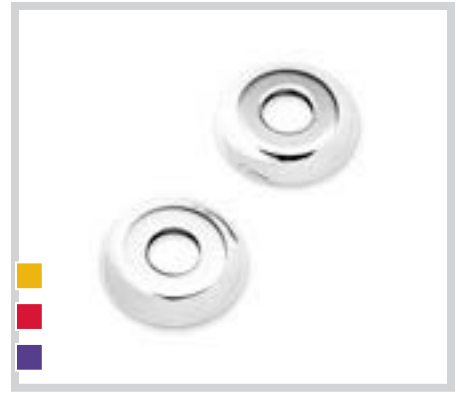

A. RISER CUP WASHER KIT – CHROME

B. HANDLEBAR CLAMP HARDWARE KIT – CHROME

Finish the show-winning look with brilliant chrome hardware. Manufactured to Original Equipment specifications, this kit replaces the zinc-plated exposed handlebar clamp bolts with chrome-plated socket head cap screws.

94451-05 **\$9.95**

Fits '05-'17 FLSTN, '94-'17 FLSTS, FLSTSB, FLSTSC, FXSTD, FXSTDSE, FXSTS and FXSTSB and '07-'08 FXSTSSE models.

94452-05 **\$9.95**

Fits '06 FXD, FXDB, FXDC and FXD35, '94-'06 FXDL, '94-'05 FXDWG, '99-'00 FXR2 and FXR3, '94-'17 FLST, FXST, FXSTB, FXSTC, '94-'08 FLSTC, '94-'06 FLSTF and '93-'96 FLSTN models.

94453-05 **\$9.95**

Fits '95-'13 XL (except XL883C, XL883N, XL1200C, XL1200L, XL1200N, XL1200V and XL1200X) and '94-'05 FXD, FXDC, FXDX, FXDXT and FXDS-CONV. models.

94454-05 **\$9.95**

Fits XL1200CX, XL1200L, XL1200N, XL1200NS, XL1200T, '96-'06 XL883C and XL1200C, '07-'17 Dyna, '00 FXR4, '05-'06 FLSTFSE, '10-'12 FLSTSE, '13-'17 FXSB, '16-'17 FXSE and '13-'14 FXSBSE models.



B. HANDLEBAR CLAMP HARDWARE KIT – CHROME

C. HANDLEBAR CLAMP BOLT COVERS

Complete the chrome hand control conversion. These thin-wall bolt covers are designed for easy installation over handlebar clamp bolts. The machined brass and chrome-plated covers are corrosion resistant and the internal spring steel retention clip resists vibration and thermal cycling to securely hold the covers in place. Kit includes 4 covers.

94413-04 **\$18.95**

Fits .3125" socket head handlebar clamp bolts. Does not fit '15-later XG, '07-'17 FLSTF, '08-'17 FXCW, FXSB, FXSBSE, '18-later FLFB, FLFBS, FXBB, FXBR, FXBR, FXBR, FXFB, FXFBS and FXLR or Touring models.



C. HANDLEBAR CLAMP BOLT COVERS

D. LIVE TO RIDE HANDLEBAR CLAMP

D. LIVE TO RIDE HANDLEBAR CLAMP

56178-92TA Gold. **\$44.95**

Fits '74-'06 XL, FX, FXR, FX Dyna and FX Softail models with stock and accessory 1.0" diameter handlebar (except '96-'06 XL883C and XL1200C and '99-'06 FXR).

E. CUSTOM HANDLEBAR CLAMPS

Fits '74-later XL, FX, FXR, FX Dyna and FX Softail models with stock and accessory 1.0" diameter handlebar (except '06-later Dyna, XL and Softail, '96-later XL Customs and '99-later FXR).

56170-83TA Classic Chrome. **\$29.95**

56567-86B Bar & Shield. **\$49.95**



E. CUSTOM HANDLEBAR CLAMPS

*NOTE: Installation of some handlebars and risers may require a change in clutch and/or throttle cable and brake lines for some models. Handlebar height is regulated in many areas. Check local laws before installation.

Model Family Fitment:

- V-ROD
- SPORTSTER
- DYNA
- SOFTAIL
- TOURING

Notice: The prices appearing in this catalog are the manufacturer's suggested retail prices. Actual retail prices may vary.

CUSTOM BRAIDED CONTROL CABLES

Dress your bike for maximum impact. Harley-Davidson offers a selection of braided cable and brake line finishes to complement your customizing style. All cables and brake lines feature a clear anti-yellowing outer jacket that provides superior scuff protection and easy maintenance. Available in stock and plus lengths for custom applications.

See your dealer for available cables and lines.

CONTROL CABLES & BRAKE LINES



DIAMONDBACK™ BRAIDED CONTROL CABLES & BRAKE LINES

Diamondback™ braided cables and lines feature a brilliant metallic finish that blends perfectly with chrome handlebars and controls or provides a stark contrast to "blacked-out" options. Fittings are finished in mirror chrome.



DIAMOND-BLACK BRAIDED CONTROL CABLES & BRAKE LINES

Diamond-Black braided cables and lines utilize a black braided wire to provide a deeper, truer, black braided finish you can see from a distance. Fittings are matched in black chrome to provide a sinister look for your ride.

CABLE & BRAKE LINE COMPONENTS

CLUTCH CABLE FEATURES

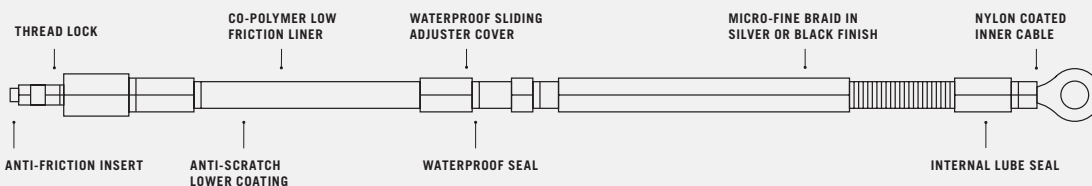

THROTTLE / IDLE CABLE FEATURES

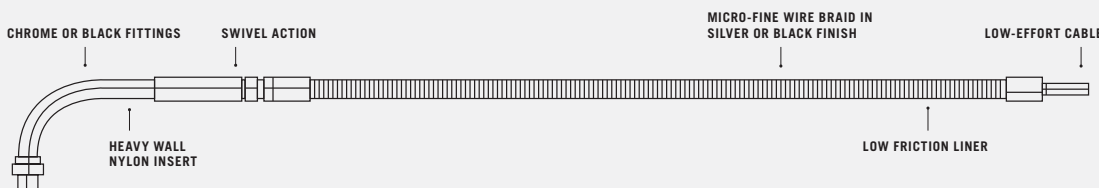

BRAKE LINE FEATURES

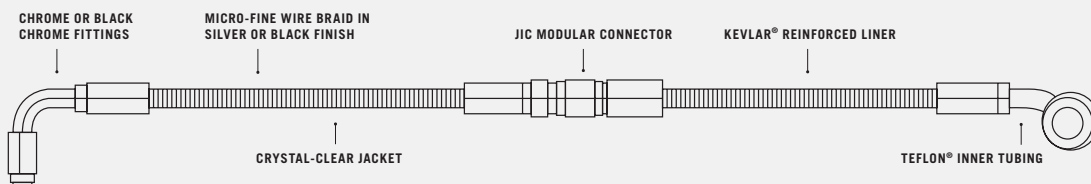

AUDIO & GAUGES

Measure your next journey in songs, not miles. With the Harley-Davidson® Boom!™ Audio sound system, you'll lose yourself in your own soundtrack. And with Bluetooth®-enabled wireless communication, you can stay connected, even in the middle of nowhere.



SELECT YOUR SYSTEM – STAGE I OR STAGE II

Your bike's factory-equipped Boom!TM Box in-dash audio system and speakers are designed to provide enjoyable full-range sound quality, at a volume level you can hear on the open road. With the addition of Boom! Audio speakers and amplifiers you'll get louder, ride-enhancing sound — thanks to increased frequency response, lower distortion and strong mid-range performance that cut through wind noise. Designed specifically for your ride, Boom! Audio equipment doesn't just sound great — it's engineered tough to withstand the harsh outdoor environment.

STAGE II

FOR THE PUREST SOUND EXPERIENCE

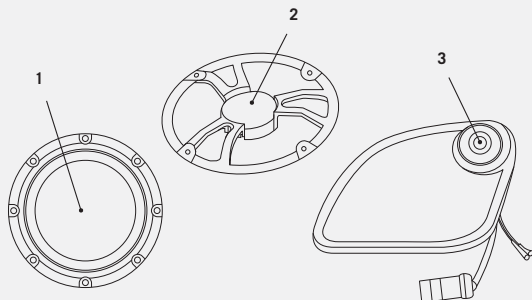

6.5" ROUND SPEAKER (ROADGLIDE® FAIRING SPEAKER SHOWN)

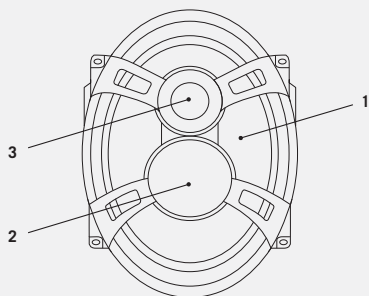

5" x 7" SADDLEBAG SPEAKER

1 WOOFER 2 MID-FREQUENCY DRIVER 3 TWEETER

Boom! Audio Stage II systems achieve the highest quality and purest sound experience on the market with the deepest bass and clearest mids and highs.

Bi-amplified, three-way 150-watt per channel speakers feature:

- A woofer, a mid-range and a tweeter that deliver low, mid and high frequencies through the best driver design
- Two 75-watt amplifier channels that power each speaker – one powers the woofer and one powers the mid-range/tweeter combo

STAGE I

FOR QUALITY SOUND AND DEEP BASS

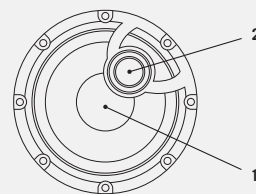

6.5" ROUND SPEAKER (BATWING® FAIRING SPEAKER SHOWN)

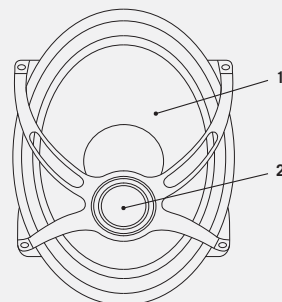

5" x 7" SADDLEBAG SPEAKER

1 WOOFER 2 TWEETER

Boom! Audio Stage I systems achieve clear highs and deep bass for great sound quality.

Single amplified, two-way 75-watt per channel speakers feature:

- A woofer and tweeter that deliver great sounding low and high frequencies
- One 75-watt amplifier channel that powers each speaker



**ELECTRA GLIDE® ULTRA CLASSIC®
WITH STAGE II BOOM!™ AUDIO SHOWN**

For a complete tour of the Boom!™ Audio Infotainment system, log on to: www.H-D.com/Owners



- 1 TOUR-PAK® SPEAKERS
- 2 BOOM! BOX 6.5GT RADIO
- 3 FAIRING SPEAKERS
- 4 AMPLIFIERS
- 5 FAIRING LOWER SPEAKERS
- 6 WIRED OR WIRELESS COMMUNICATION
- 7 SADDLEBAG LID SPEAKERS

STAGE I BOOM!™ AUDIO SYSTEMS

Boom!™ Audio Stage I systems take your sound to the next level. When compared to the factory installed Original Equipment audio system, Boom! Audio Stage I speakers feature larger woofers for deeper bass and soft-dome tweeters for better balanced sound quality. Efficient Stage I speakers can be easily powered with the built-in amplifier in the factory-installed Boom Box Infotainment System, or with the addition of Boom!™ Audio amplifiers, the larger speakers can produce more volume at all frequencies. A custom EQ was developed for each configuration of speakers to get the most out of the Stage I system.

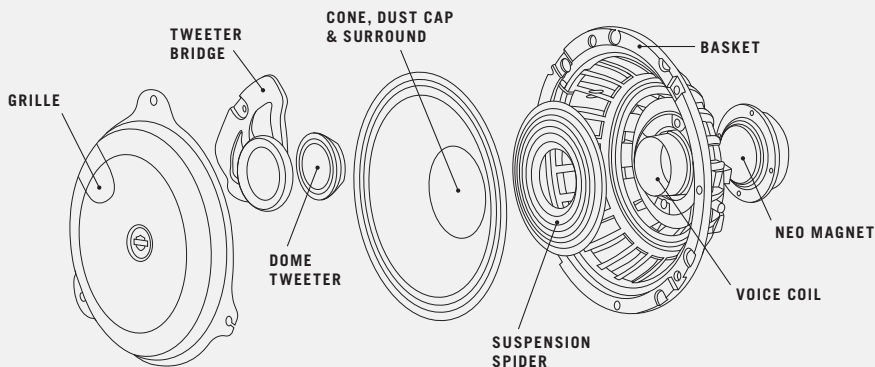

STAGE I BOOM!™ AUDIO – CUTS THROUGH ROAD NOISE TO DELIVER EVERY NOTE							
THE FIRST STEP – Add amplifier(s) and upgrade the factory speakers							
Street Glide® & Road Glide®				Electra Glide® & Road Glide® Ultra			
What are my Options?	Speaker Locations	Sound Output	# of Speakers/ Amplifiers	What are my Options?	Speaker Locations	Sound Output	# of Speakers/ Amplifiers
Upgrade Stock Speakers			2/1 150 watts	Upgrade Stock Speakers			4/1 300 watts
WANT MORE? HERE ARE YOUR OPTIONS.							
I RIDE SOLO 4-Speaker*			4/1 300 watts	I RIDE SOLO 6-Speaker*			6/2 450 watts
I RIDE TWO-UP 4-Speaker*			4/1 300 watts	I RIDE TWO-UP 6-Speaker*			6/2 450 watts
I RIDE SOLO & 2-UP 6-Speaker*			6/2 450 watts	THE ULTIMATE SYSTEM 8-Speaker*			8/2 600 watts
THE ULTIMATE SYSTEM 8-Speaker*			8/2 600 watts	<ul style="list-style-type: none"> ● = Factory Speaker Locations ● = Additional Speaker Locations* 			

AUDIO & GAUGES 659

Boom!™ Audio – Stage I



A. BOOM! AUDIO AMPLIFIER

A. BOOM!™ AUDIO AMPLIFIER KIT

Take your music to the streets. Boom!™ Audio Amplifier Kits allow you to crank up the volume with significantly less distortion. The amplifier provides more power than Original Equipment radio alone, resulting in increased volume, fuller sound reproduction, reduced clipping and lower Total Harmonic Distortion (THD) than head unit alone. Unlike after-market amplifiers that connect between the radio and the speakers, the Boom! Audio amplifier bypasses the radio's internal power amp to produce the cleanest sound possible. The Boom! Audio Amplifier boosts the pure source signal, minimizing any distortion generated through the speaker output. The system-matched high-output signal features optimized sound equalization for crisp, clear vocals and maximum bass response and the strong midrange response cuts through wind and road noise. The marine grade 4-channel, 75-watts/channel amplifier (300-watt total) has been designed from the ground-up for the harsh motorcycle environment. Fairing Mounted kit includes all mounting hardware and wiring harness. Note: The use of the Boom! Audio Amplifier turns off the radio's internal amplifier.

76000278 Fairing Mounted. **\$599.95**

Fits '14-later Electra Glide®, Street Glide®, Ultra Limited and Tri Glide® models equipped with a Boom! Box audio system. Dealer Digital Technician™ software update is required. Dealer installation is recommended. Separate purchase of Power Extension Harness P/N 69200921 is required if installed with Hidden AM/FM/WB Antenna P/N 76000513, Electra Glo™ Headlamp Trim Rings or Fairing Edge Lights.

76000523 Fairing Mounted. **\$599.95**

Fits '15-later FLTRU, FLTRX and FLTRXS models. Original Equipment on '15-later CVO™ Road Glide® model. Dealer Digital Technician software update is required. Dealer installation is recommended. Separate purchase of Power Extension Harness P/N 69200921 is required if installed with Hidden AM/FM/WB Antenna P/N 76000513, Electra Glo Headlamp Trim Rings or Fairing Edge Lights.

B. BOOM! AUDIO STAGE I SPEAKER EXPANSION KIT

Add more Boom! to your bike. This kit permits the addition of a third or fourth pair of speakers to your Boom! Audio-equipped Touring bike. Choose a combination of Boom! Audio Fairing Lower Speakers and/or Rear Speaker Pods (sold separately) to build a sound system custom-designed to your audio demands. System also provides speaker fade capabilities between fairing and non-fairing mounted speakers for high-way riding, when it's needed most. Kit includes 75-watt/channel (300-watts total) saddlebag-mounted amplifier, amplifier cover, mounting bracket and the required installation hardware and wiring harness. NOTE: The use of the Boom! Audio Amplifier turns off the radio's internal amplifier.

Fits Touring models equipped with a Boom! Box audio system. Required to add a 3rd or 4th set of Boom! Audio Stage I speakers. '18-later FLHTKSE models requires separate purchase of Harness P/N 69201930. Dealer Digital Technician software update is required. Dealer installation is recommended. Not compatible with models equipped with Boom! Audio Stage II components.

76000748 Fits '17-later models. **\$699.95**

76000280 Fits '14-'16 models. **\$699.95**



A. BOOM! AUDIO AMPLIFIER KIT – (76000278 SHOWN)



A. BOOM! AUDIO AMPLIFIER KIT – (76000523 SHOWN)



B. BOOM! AUDIO STAGE I SPEAKER EXPANSION KIT

Model Family Fitment:

- V-ROD
- SPORTSTER
- DYNA
- SOFTAIL
- TOURING

Notice: The prices appearing in this catalog are the manufacturer's suggested retail prices. Actual retail prices may vary.

660 AUDIO & GAUGES

Boom!™ Audio – Stage I

BOOM!™ AUDIO STAGE I BAGGER AMP & SPEAKER KITS

Fill the air with sound from this Boom!™ Audio Boom Bagger Kit. Available to fit 2- and 4-speaker models, this complete audio kit provides the latest in Harley-Davidson® audio components. When installed, the increased power of the amplifier provides the speakers with a clean signal and a custom equalization is available to further optimize the performance of the Boom! Audio speaker system. Speakers feature two-year warranty. Dealer Digital Technician™ software update is required. Dealer installation is recommended. Ensure maximum output of your audio system with the recommended High Output Charging System P/N 29900028A. Note: The use of the Boom! Audio Amplifier turns off the radio's internal amplifier. Installation of a third or fourth set of Stage I speakers requires the Boom! Audio Speaker Expansion Kit.

A. 4-SPEAKER ULTRA BOOM! BAGGER KIT

Kit includes Boom! Audio 6.5" fairing and rear speakers, Boom! Audio 4-channel fairing-mounted amplifier, amplifier mount and wiring harness. Boom! Audio speakers feature a two-year warranty.

76000411A **\$999.95**

Fits '14-later FLHTCU, FLHTCUL, FLHTK, FLHTKL and FLHTCUTG models. Also fits '14-later FLHX and '14-'17 FLHXS models equipped with King Tour-Pak® luggage and rear speaker pods. Dealer Digital Technician software update is required. Dealer installation is recommended. Separate purchase of Power Extension Harness P/N 69200921 is required if installed with Hidden AM/FM/WB Antenna P/N 76000513, Electra Glo™ Headlamp Trim or Fairing Edge Lights.

76000671A **\$1,029.95**

Fits '16-later FLTRU models. Also fits '15-later FLTRX and '15-'17 FLTRXS models equipped with King Tour-Pak and rear speaker pods. Dealer Digital Technician software update is required. Dealer installation recommended. Separate purchase of Power Extension Harness P/N 69200921 is required if installed with Hidden AM/FM/WB Antenna P/N 76000513.

B. 2-SPEAKER BOOM! BAGGER KIT

Kit includes Boom! Audio 6.5" fairing speakers, Boom! Audio 4-channel fairing-mounted amplifier, amplifier mount and wiring harness. Kit can easily be upgraded to a 4-speaker system with the addition of Saddlebag Lid Speakers, Fairing Lower Speakers or a Tour-Pak and Rear Speaker Enclosures. Boom! Audio speakers feature a two-year warranty.

76000410A **\$799.95**

Fits '14-later FLHX and '14-'17 FLHXS models. Dealer Digital Technician software update is required. Dealer installation is recommended. Separate purchase of Power Extension Harness P/N 69200921 is required if installed with Hidden AM/FM/WB Antenna P/N 76000513, Electra Glo Headlamp Trim or Fairing Edge Lights.

76000587A **\$829.95**

Fits '15-later FLTRX and '15-'17 FLTRXS models. Dealer Digital Technician software update is required. Dealer installation is recommended. Separate purchase of Power Extension Harness P/N 69200921 is required if installed with Hidden AM/FM/WB Antenna P/N 76000513, Electra Glo Headlamp Trim or Fairing Edge Lights.



A. BOOM! AUDIO STAGE I BAGGER AMP & SPEAKER KIT – ULTRA 4-SPEAKER KIT (76000411A SHOWN)



B. BOOM! AUDIO STAGE I BAGGER AMP & SPEAKER KIT – ULTRA 4-SPEAKER KIT (76000671A SHOWN)



B. BOOM! AUDIO STAGE I BAGGER AMP & SPEAKER KIT – STREET GLIDE 2-SPEAKER KIT



B. BOOM! AUDIO STAGE I BAGGER AMP & SPEAKER KIT – ROAD GLIDE 2-SPEAKER KIT

Notice: The prices appearing in this catalog are the manufacturer's suggested retail prices. Actual retail prices may vary.

AUDIO & GAUGES 661

Boom!™ Audio – Stage I



C. BOOM! AUDIO STAGE I FAIRING SPEAKER KIT – BATWING



C. BOOM! AUDIO STAGE I FAIRING SPEAKER KIT – ROAD GLIDE



D. BOOM! AUDIO STAGE I SADDLEBAG SPEAKER KIT

C. BOOM!™ AUDIO STAGE I FAIRING SPEAKERS

Make the whole world sing. Boom!™ Audio Speakers are designed to maximize music volume and clarity in the harsh motorcycle environment. The full-range two-way speakers feature high strength, larger than stock polypropylene 6.5" cones for improved low and mid frequencies and bridge-mounted damped soft-dome 1.0" tweeters for improved high frequencies. Composite frame and high-performance magnet increase the speaker's power-handling capabilities. The weather and vibration resistant speakers are protected behind perforated metal grills and are sized as a direct replacement for the Original Equipment sound system. Complete kit includes 2 two-way speakers, metal grills and plug-in wiring connection. Boom! Audio speakers feature a two-year warranty.

76000317A 6.5" Batwing Fairing Speakers. **\$199.95**
Fits '14-later FLHTCU, FLHTCUL, FLHTK, FLHTKL, FLHX, FLXS and FLHTCUTG models. Original Equipment on '18-later FLHXS models.

76000548A 6.5" Road Glide® Fairing Speakers. **\$229.95**
Fits '15-later Road Glide models. Original Equipment on '15-later CVO™ Road Glide and '18-later FLTRXS models.

D. BOOM! AUDIO STAGE I SADDLEBAG SPEAKER KIT

Boom! Audio Saddlebag Speakers increase the available sound pressure level (SPL) and produce higher listening volume, lower distortion and improved clarity at highway speeds. The pair of 5" x 7" waterproof 2-ohm full range speakers feature high strength woofer cones and suspended 25mm tweeters that are directionally optimized for improved rider acoustics. Extensively tested to withstand the harshest riding conditions, the speakers fit seamlessly in custom-designed saddlebag lids (sold separately) and are covered by stylish and durable perforated metal speaker grills. Kit includes left and right speakers, grills, rear wiring harness and installation hardware. Color-matched saddlebag lids sold separately. Boom! Audio speakers feature a two-year warranty.

76000489A **\$399.95**
Fits '14-later FLHTCU, FLHTCUL, FLHTK, FLHTKL, FLHX, FLXS, FLTRU, FLTRX and FLTRXS models. Requires separate purchase of appropriate Saddlebag Lids. Dealer Digital Technician™ software update is required. Dealer installation is recommended.

Model Family Fitment:

- V-ROD
- SPORTSTER
- DYNA
- SOFTAIL
- TOURING

Notice: The prices appearing in this catalog are the manufacturer's suggested retail prices. Actual retail prices may vary.

662 AUDIO & GAUGES

Boom!™ Audio – Stage I

A. BOOM!™ AUDIO STAGE I FAIRING LOWER SPEAKER KIT

Boom!™ Audio Fairing Lower Speakers provide two additional sound sources directed at the rider for a concert-hall sound experience. Adding fairing lower speakers to your current two-speaker system increases the available sound pressure level, permitting higher listening volume, lower distortion and improved clarity at highway speeds. The pair of 6.5" waterproof 2-ohm full range speakers feature suspended 1.0" soft-dome tweeters that are directionally optimized for improved rider acoustics. A molded tray fits tightly into the fairing lower and forms a sound-optimized ported speaker enclosure for improved bass performance. The speakers mount to the fairing lowers with color-matched speaker boxes (sold separately). Kit includes left and right speakers, perforated metal speaker grills, ported lower tray and installation hardware. Fairing lowers sold separately. Boom! Audio speakers feature a two-year warranty.

76000487A **\$279.95**

Fits '14-later FLHTCU, FLHTCUL, FLHX, FLHXS, FLTRX and FLTRXS models equipped with vented fairing lowers. Does not fit models equipped with Twin-Cooled™ engines.



A. BOOM! AUDIO STAGE I FAIRING LOWER SPEAKER KIT

B. BOOM!™ AUDIO STAGE I/II FAIRING LOWER SPEAKER KIT – TWIN-COOLED™ MODELS

Designed for installation in the Original Equipment fairing lowers of Twin-Cooled Touring models, these vibration-tested waterproof two-way speakers feature rider directed tweeters for clear, crisp sound. The 4" bass/midrange driver and the grill-mounted 1" tweeter are performance-optimized to complement the sound characteristics of both Stage I and Stage II Boom! Audio systems, and provide higher listening volumes with reduced distortion at highway speeds. For easy installation, the speakers are pre-mounted to a backing plate that snaps in place, replacing the fairing lower cooling system access doors. The speakers can be easily removed to check coolant levels. Complete kit includes left and right two-way speakers and wiring harness. Boom! Audio speakers feature a two-year warranty.

76000660 **\$299.95**

Fits '14-later FLHTCU-TC, FLHTK, FLHTKL, FLHTKSE, FLHXSE, FLTRU and FLTRUSE models with Twin-Cooled engines. Use on vehicles equipped with Stage II Boom! Audio systems requires the separate purchase of Boom! Audio Amplifier Kit P/N 76000277B and Speaker Installation Kit P/N 76000586 or 76000749. FLHXSE models require separate purchase of Installation Kit P/N 76000734. Does not fit FLHXSE models equipped with Tour-Pak luggage. Does not fit FLHTKSE models equipped with Boom! Audio Stage II. Not compatible with Screamin' Eagle® Heavy Breather Kits.



B. BOOM! AUDIO STAGE I/II FAIRING LOWER SPEAKER KIT – TWIN-COOLED MODELS

C. BOOM!™ AUDIO STAGE I TOUR-PAK® AND TRIKE BODY SPEAKER KIT

Make the whole world sing. Boom! Audio Speakers are designed to maximize music volume and clarity in the harsh motorcycle environment. The full-range two-way speakers feature high strength, larger than stock polypropylene 6.5" cones for improved low and mid frequencies and bridge-mounted damped soft-dome 1.0" tweeters for improved high frequencies. Composite frame and high-performance magnet increase the speaker's power-handling capabilities. The weather and vibration resistant speakers are protected behind perforated metal grills and are sized as a direct replacement for the Original Equipment sound system. Complete kit includes 2 two-way speakers, metal grills and plug-in wiring connection. Boom! Audio speakers feature a two-year warranty.

76000318A 6.5" Rear Speakers. **\$199.95**

Fits '14-later FLHTCU, FLHTCUL, FLHTK and FLHTKL, '16-later FLTRU and '14-later FLHTCUTG models. Also fits FLHX, FLHXS, FLTRX and FLTRXS models equipped with a King Tour-Pak® and Rear Speaker Enclosure Kit. Trike body installation requires separate purchase of Trike Body Installation Kit P/N 76000617.



C. BOOM! AUDIO STAGE I SPEAKER KIT – TOUR-PAK AND TRIKE BODY

Notice: The prices appearing in this catalog are the manufacturer's suggested retail prices. Actual retail prices may vary.

AUDIO & GAUGES 663

Boom!™ Audio – Stage I



D. TOUR-PAK REAR SPEAKER ENCLOSURE KIT

D. TOUR-PAK® REAR SPEAKER ENCLOSURE KIT

Add concert-hall sound to your motorcycle. Tour-Pak® Rear Speaker Enclosures enable the installation of Boom!™ Audio 6.5" Rear Speakers on Street Glide® and Road Glide® models equipped with King Tour-Pak luggage. Enclosure Kit includes rear speaker pods and wiring harness for speaker hook-up. Boom! Audio Stage I Tour-Pak 6.5" Rear Speaker Kit P/N 76000318 or Stage II Kit P/N 76000526 sold separately.

76000505 Fits '14-later FLHX, FLHXS, FLTRX and FLTRXS models equipped with King Tour-Pak luggage. Does not fit with Solo Tour-Pak Mounting Rack P/N 53000225. **\$249.95**

E. BOOM!™ AUDIO SPEAKER INSTALLATION KIT – TRIKE BODY*

Add more Boom to your Tri Glide® Trike model. This kit integrates a third set of 6.5" Boom! Audio Speakers in the kick panels of the Tri Glide model, and directs the increased sound pressure level directly at the rider and passenger. The kit includes left and right hidden speaker enclosures, speaker adapter rings, amplifier brackets, wiring harness, hardware and installation template. Amplifier and your choice of Boom! Audio Stage I or II speakers are sold separately.

Fits FLHTCUTG models. Not compatible with Passenger Armrests P/N 52400106 or Trike Saddlebags P/N 84031-11.

76000747 Fits '17-later models. **\$299.95**

76000617 Fits '14-'16 models. **\$299.95**



E. BOOM! AUDIO SPEAKER INSTALLATION KIT – TRIKE BODY

F. COLOR-MATCHED FAIRING LOWER SPEAKER BOXES

Speaker boxes replace the Original Equipment glove boxes and direct the sound toward the rider and passenger. Kit includes left and right speaker box and required hardware.

Fits '14-later Touring models equipped with vented fairing lowers and Boom! Audio Fairing Lower Speaker Kit P/N 76000487. Does not fit models with Twin-Cooled™ engines.

See page 795 for complete list of available Color-Matched options.

G. COLOR-MATCHED SADDLEBAG SPEAKER LIDS

Custom saddlebag lids are shaped to accommodate Boom! Audio Saddlebag Lid Speakers. Speaker openings are formed to angle the speakers and direct the sound forward toward the rider and passenger. Kit reuses Original Equipment hinges, locks and mounting hardware.

Fits '14-later Touring models equipped with Boom! Audio Saddlebag Speaker Kit P/N 76000489.

See page 795 for complete list of available Color-Matched options.



F. COLOR-MATCHED FAIRING LOWER SPEAKER BOXES



G. COLOR-MATCHED SADDLEBAG SPEAKER LIDS

*NOTE: '14-'16 Boom! Audio Stage II systems with 6 or 8 speakers require installation of High-Output Charging System P/N 29900028A.

Model Family Fitment:

V-ROD
 SPORTSTER
 DYNA

 SOFTAIL
 TOURING

Notice: The prices appearing in this catalog are the manufacturer's suggested retail prices. Actual retail prices may vary.

STAGE II BOOM!™ AUDIO SYSTEMS

Boom!™ Audio Stage II systems give you the very best motorcycle sound experience. Stage II systems are based on a bi-amplified, three-way speaker design. Each Stage II speaker features a separate woofer, mid-range and tweeter element that allow frequencies to be delivered with the optimum driver design. Each speaker is powered by two channels from the amplifier — one for the woofer, and the second for the mid-range/tweeter combination — for a total output of 150 watts/speaker. This doubling of the power allows you to play your music louder with far less distortion than traditional systems.

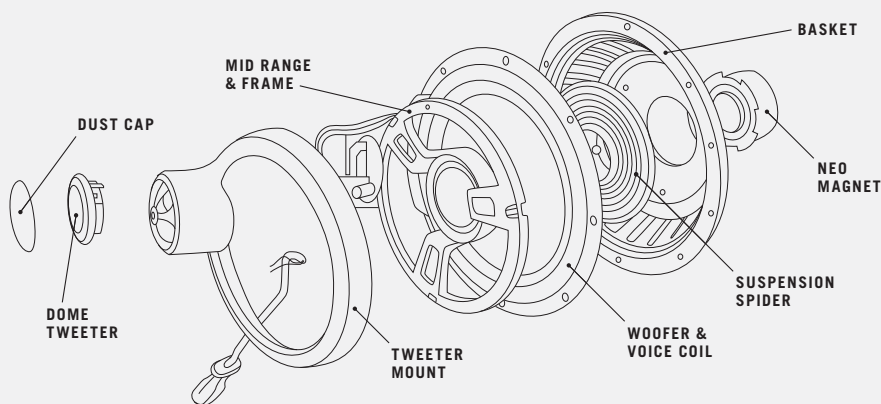

STAGE II BOOM!™ AUDIO – DELIVERS A PURE HIGH-POWERED CONCERT HALL EXPERIENCE

THE FIRST STEP – Add amplifier(s) and upgrade the factory speakers

Street Glide® & Road Glide®

Electra Glide® & Road Glide® Ultra

What are my Options?	Speaker Locations	Sound Output	# of Speakers/ Amplifiers	What are my Options?	Speaker Locations	Sound Output	# of Speakers/ Amplifiers
Upgrade Stock Speakers			2/1 300 watts	Upgrade Stock Speakers			4/2 600 watts

WANT MORE? HERE ARE YOUR OPTIONS.

I RIDE SOLO 4-Speaker*			4/2 600 watts	I RIDE SOLO 6-Speaker*			6/3 900 watts
I RIDE TWO-UP 4-Speaker*			4/2 600 watts	I RIDE TWO-UP 6-Speaker*			6/3 900 watts
I RIDE SOLO & 2-UP 6-Speaker*			6/3 900 watts	THE ULTIMATE SYSTEM 8-Speaker*			8/4 1200 watts
THE ULTIMATE SYSTEM 8-Speaker*			8/4 1200 watts	<ul style="list-style-type: none"> ● = Factory Speaker Locations ● = Additional Speaker Locations* 			

Boom!™ Audio Stage II Fitment Matrix

FLHX/FLHXS*

Fairing	Fairing Speakers	76000524A
	Fairing Amp w/Mount	76000278

Saddlebag	Saddlebag Lid Speakers	76000319A
	Installation Kit – '14-'16	76000584
	Installation Kit – '17-later	76000745
	Saddlebag Speaker Amp	76000277B
	Saddlebag Lids – Left†	90200827
Saddlebag Lids – Right†	90200826	

Fairing Lower	Fairing Lower Speakers**	76000353A
	Installation Kit – '14-'16	76000586
	Installation Kit – '17-later	76000749
	Fairing Lower Speaker Amp	76000277B
	Fairing Lower Speaker Boxes†	76000497

Tour-Pak	Tour-Pak® Speakers***	76000526A
	Installation Kit – '14-'16	76000585
	Installation Kit – '17-later	76000751
	Tour-Pak Speaker Amp	76000277B
	Tour-Pak Speaker Pods	76000505

FLTRX/FLTRXS*

Fairing	Fairing Speakers	76000594A
	Fairing Amp w/Mount	76000523

Saddlebag	Saddlebag Lid Speakers	76000319A
	Installation Kit – '14-'16	76000584
	Installation Kit – '17-later	76000745
	Saddlebag Speaker Amp	76000277B
	Saddlebag Lids – Left†	90200827
Saddlebag Lids – Right†	90200826	

Fairing Lower	Fairing Lower Speakers**	76000353A
	Installation Kit – '14-'16	76000586
	Installation Kit – '17-later	76000749
	Fairing Lower Speaker Amp	76000277B
	Fairing Lower Speaker Boxes†	76000497

Tour-Pak	Tour-Pak Speakers***	76000526A
	Installation Kit – '14-'16	76000585
	Installation Kit – '17-later	76000751
	Tour-Pak Speaker Amp	76000277B
	Tour-Pak Speaker Pods	76000505

FLHTCUTG (Twin-Cooled™)*

Fairing & Tour-Pak	Fairing Speakers	76000524A
	Fairing Amp w/Mount	76000278
	Tour-Pak Speakers	76000526A
	Installation Kit – '14-'16	76000618
	Installation Kit – '17-later	76000746
Tour-Pak Speaker Amp	76000277B	

Body	Trike Body Speakers	76000526A
	Installation Kit – '14-'16	76000617
	Installation Kit – '17-later	76000747
	Trike Body Speaker Amp	76000277B

FLHTCU/FLHTCUL (Air/Oil-Cooled)*

Fairing & Tour-Pak	Fairing Speakers	76000524A
	Fairing Amp w/Mount	76000278
	Tour-Pak Speakers	76000526A
	Installation Kit – '14-'16	76000585
	Installation Kit – '17-later	76000751
Tour-Pak Speaker Amp	76000277B	

Fairing Lower	Fairing Lower Speakers	76000353A
	Installation Kit – '14-'16	76000586
	Installation Kit – '17-later	76000749
	Fairing Lower Speaker Amp	76000277B
	Fairing Lower Speaker Boxes†	76000497

Saddlebag	Saddlebag Lid Speakers	76000319A
	Installation Kit – '14-'16	76000584
	Installation Kit – '17-later	76000745
	Saddlebag Speaker Amp	76000277B
	Saddlebag Lids – Left†	90200827
Saddlebag Lids – Right†	90200826	

FLHTCU/FLHTCUL/FLHTK/FLHTKL (Twin-Cooled)*

Fairing & Tour-Pak	Fairing Speakers	76000524A
	Fairing Amp w/Mount	76000278
	Tour-Pak Speakers	76000526A
	Installation Kit – '14-'16	76000585
	Installation Kit – '17-later	76000751
Tour-Pak Speaker Amp	76000277B	

Fairing Lower	Fairing Lower Speakers	76000660
	Installation Kit – '14-'16	76000586
	Installation Kit – '17-later	76000749
	Fairing Lower Speaker Amp	76000277B

Saddlebag	Saddlebag Lid Speakers	76000319A
	Installation Kit – '14-'16	76000584
	Installation Kit – '17-later	76000745
	Saddlebag Speaker Amp	76000277B
	Saddlebag Lids – Left†	90200827
Saddlebag Lids – Right†	90200826	

FLTRU (Twin-Cooled)*

Fairing & Tour-Pak	Fairing Speakers	76000594A
	Fairing Amp w/Mount	76000523
	Tour-Pak Speakers	76000526A
	Installation Kit – '14-'16	76000585
	Installation Kit – '17-later	76000751
Tour-Pak Speaker Amp	76000277B	

Fairing Lower	Fairing Lower Speakers	76000660
	Installation Kit – '14-'16	76000586
	Installation Kit – '17-later	76000749
	Fairing Lower Speaker Amp	76000277B

Saddlebag	Saddlebag Lid Speakers	76000319A
	Installation Kit – '14-'16	76000584
	Installation Kit – '17-later	76000745
	Saddlebag Speaker Amp	76000277B
	Saddlebag Lids – Left†	90200827
Saddlebag Lids – Right†	90200826	

'14-'17 FLHXSE (Twin-Cooled)*

Fairing Lower	Fairing Lower Speakers	76000660
	Installation Kit – '14-'16	76000586
	Installation Kit – '17-later	76000749
	Fairing Lower Speaker Amp	76000277B
Installation Kit	76000734	

Tour-Pak	Tour-Pak Speakers***	76000526A
	Installation Kit – '14-'16	76000585
	Installation Kit – '17-later	76000751
	Tour-Pak Speaker Amp	76000277B
	Tour-Pak Speaker Pods	76000505
Audio Input Harness – '15-'16	69201477	

'18 FLTRXSE/FLTRXSE (Air/Oil-Cooled)

Tour-Pak	Tour-Pak Speakers	76000526A
	Installation Kit	76000751
	T-Pak Speaker Amp	76000277B
	T-Pak Speaker Pods	76000505

FLHTKSE (Twin-Cooled)*

Fairing & Tour-Pak	Fairing Speakers	76000524A
	Tour-Pak Speakers	76000526A
	Installation Kit – '14-'16	76000585
	Installation Kit – '17-later	76000751
	Tour-Pak Speaker Amp	76000277B
	Interconnect Harness – '14-'17	69200714
	Interconnect Harness – '17-later	69201930
	Jumper Harness	69200489

Saddlebag	Saddlebag Lid Speakers	76000319A
	Installation Kit – '14-'16	76000584
	Installation Kit – '17-later	76000745
	Saddlebag Speaker Amp	76000277B
	Saddlebag Lids – Left†	90200827
Saddlebag Lids – Right†	90200826	
Saddlebag Handle Kit	90201116	

FLTRUSE (Twin-Cooled)*

Fairing & Tour-Pak	Fairing Speakers	76000594A
	Tour-Pak Speakers	76000526A
	Installation Kit – '14-'16	76000585
	Installation Kit – '17-later	76000751
	Tour-Pak Speaker Amp	76000277B
Interconnect Harness	69200714	
Jumper Harness	69200489	

Saddlebag	Saddlebag Lid Speakers	76000319A
	Installation Kit – '14-'16	76000584
	Installation Kit – '17-later	76000745
	Saddlebag Speaker Amp	76000277B
	Saddlebag Lids – Left†	90200827
Saddlebag Lids – Right†	90200826	
Saddlebag Handle Kit	90201116	

* '14-'16 models with 6- and 8- Speaker Systems require installation of High Output Charging System P/N 29900028A.

** Requires separate purchase of Vented Fairing Lower.

*** Requires separate purchase of King Tour-Pak® and Rigid Tour-Pak Mounting Rack.

† Denotes Color-Matched product.

NOTE: Boom!™ Audio Stage I and Boom! Audio Stage II components are not compatible.

666 AUDIO & GAUGES

Boom!™ Audio – Stage II

BOOM!™ AUDIO STAGE II COMPONENTS*

Headline your own concert tour. Big and bold is the best way to describe the musical performance you will experience when listening to your favorite band through a Boom!™ Audio Stage II sound system. The weather-proof 3-way speakers feature high-exursion woofers for extended bass performance, and separate mid- and high-frequency drivers for rich vocals and startlingly real treble notes. Powered by a dedicated 300 watt RMS amplifier, each pair of speakers is capable of producing "filling-rattling" volume. Designed to work seamlessly with the factory installed Boom! Audio infotainment head unit, the Boom! Stage II components are system matched and feature custom tuned static and dynamic equalization that dial in the ideal setup for your ride. And you can choose how far you want to go. From a single pair of fairing mounted speakers and a 300 watt amp to a full bore 8 speaker, 4 amp, 1200 watt system, we've got you covered.

A. BOOM! AUDIO AMPLIFIER KIT

Take your music to the streets. Boom! Audio Amplifier Kits allow you to crank up the volume with significantly less distortion. The amplifier provides more power than Original Equipment radio alone, resulting in increased volume, fuller sound reproduction, reduced clipping and lower Total Harmonic Distortion (THD). Unlike aftermarket amplifiers that connect between the radio and the speakers, the Boom! Audio amplifier bypasses the radio's internal power amp to produce the cleanest sound possible. The Boom! Audio Amplifier boosts the pure source signal, minimizing any distortion generated through the speaker output. The system-matched high-output signal features optimized sound equalization for crisp, clear vocals and maximum bass response and the strong midrange response cuts through wind and road noise. The marine grade 4-channel, 75-watts RMS/channel amplifier (300-watt RMS total) has been designed from the ground-up for the harsh motorcycle environment. Fairing Mounted kit includes all mounting hardware and wiring harness. Note: The use of the Boom! Audio Amplifier turns off the radio's internal amplifier.

76000278 Fairing Mounted. **\$599.95**
Fits '14-later Electra Glide®, Street Glide®, Ultra Limited and Tri Glide® models equipped with a Boom! Box audio system. Dealer Digital Technician™ software update is required. Dealer installation is recommended. Separate purchase of Power Extension Harness P/N 69200921 is required if installed with Hidden AM/FM/WB Antenna P/N 76000513, Electra Glo™ Headlamp Trim Rings or Fairing Edge Lights.

76000523 Fairing Mounted. **\$599.95**
Fits '15-later FLTRU, FLTRX and FLTRXS models. Original Equipment on '15-later CVO™ Road Glide® model. Dealer Digital Technician software update is required. Dealer installation is recommended. Separate purchase of Power Extension Harness P/N 69200921 is required if installed with Hidden AM/FM/WB Antenna P/N 76000513, Electra Glo Headlamp Trim Rings or Fairing Edge Lights.

76000277B Amplifier only. **\$449.95**
Fits '14-later Touring and Tri Glide models equipped with a Boom! Box audio system. Required to add a 2nd, 3rd or 4th set of Boom! Audio Stage II speakers. If installing more than 2 amplifiers, separate purchase of Electrical Accessory Adapter P/N 70270-04A is required. Dealer Digital Technician software update is required. Dealer installation is recommended.

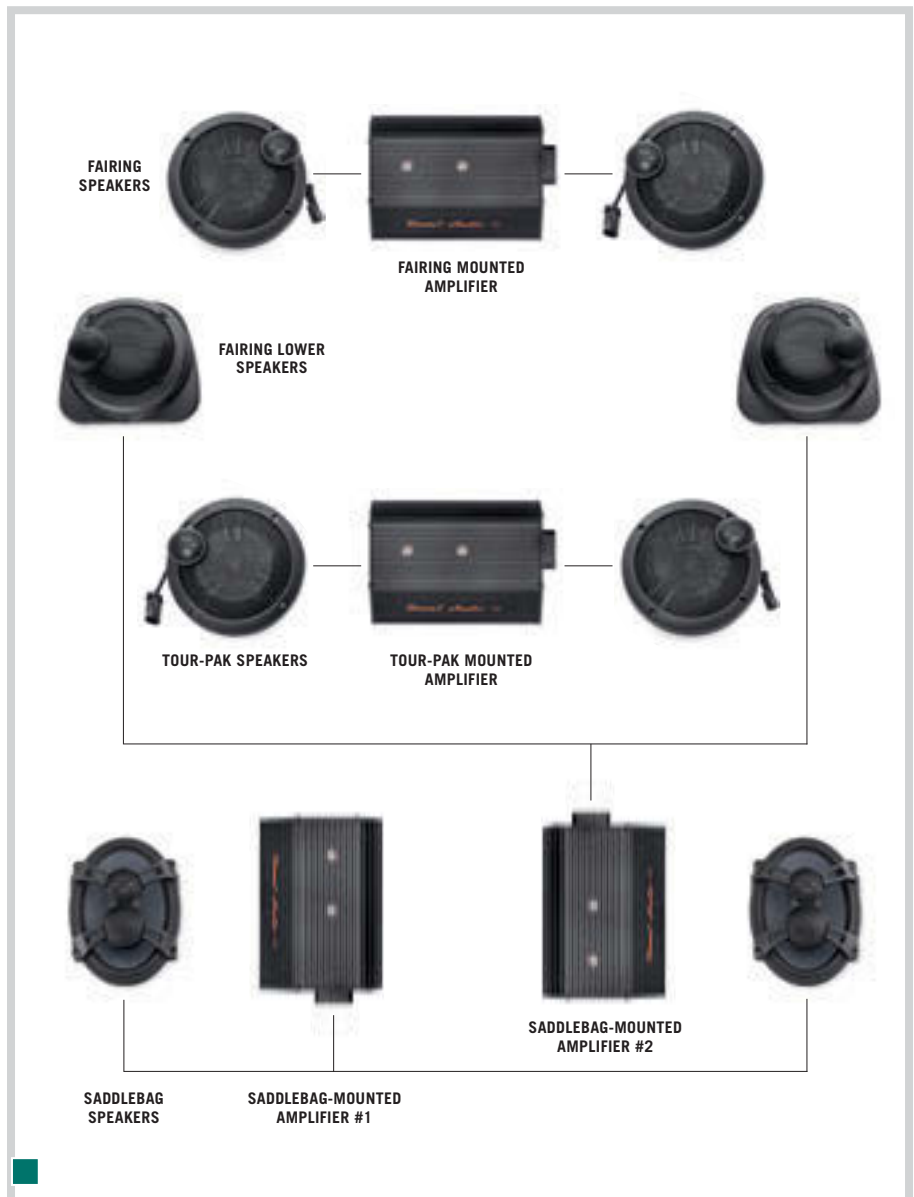

A. BOOM! AUDIO – STAGE II COMPONENTS



A. BOOM! AUDIO AMPLIFIER KIT – (76000278 SHOWN)



A. BOOM! AUDIO AMPLIFIER KIT – (76000523 SHOWN)

Notice: The prices appearing in this catalog are the manufacturer's suggested retail prices. Actual retail prices may vary.

AUDIO & GAUGES 667

Boom!™ Audio – Stage II

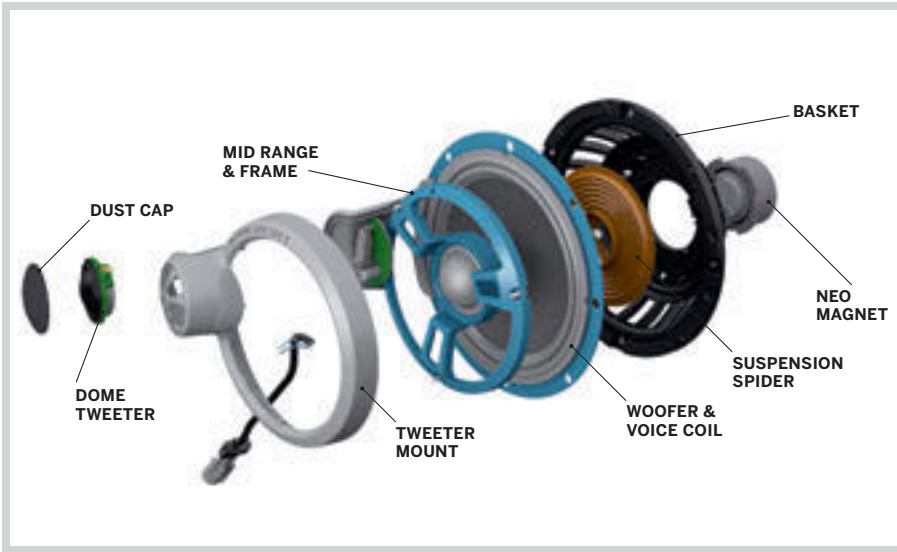

B. BOOM! AUDIO STAGE II SPEAKER COMPONENTS

B. BOOM!™ AUDIO STAGE II SPEAKER KIT – FAIRING*

Designed for increased volume, sound quality and durability, Stage II Fairing Speakers feature a 6.5" long-throw woofer for low frequencies, a bridge mounted mid-frequency driver, and a separate tweeter for high-frequencies. Like true audiophile components, each speaker is powered by two channels from our 300 watt RMS amplifier – one channel powers the woofer, and another powers the mid/tweeter combo. When powered by separate dedicated bass and high-frequency amplifier channels, you are doubling the power to each speaker when compared to our Boom!™ Audio Stage I system. The results? You get thumping bass response, sizzling vocals and clean, distortion free performance at all volume levels. Built with composite speaker frames, powerful magnets and protective perforated metal grills, these weather and vibration resistant speakers are designed for life on the road. Complete kit includes 2 three-way speakers, grills and plug-in connections. Separate purchase of fairing mount amplifier is required. Boom! Audio speakers feature a two-year warranty.

76000524A Batwing Fairing. **\$329.95**

Fits '14-later FLHTCU, FLHTCUL, FLHTK, FLHTKL, FLHTKSE, FLHX, FLHXS and FLHTCUTG models. Stock on '15-later FLHXSE models. Requires separate purchase of a Boom! Audio accessory amplifier. Not compatible with models equipped with Stage I Boom! Audio components. Dealer installation and software updates are required.

76000594A Road Glide® Fairing. **\$359.95**

Fits '15-later FLTRU, FLTRUSE, FLTRX and FLTRXS models. Stock on '18-later FLTRXSE models. Requires separate purchase of a Boom! Audio accessory amplifier. Not compatible with models equipped with Stage I Boom! Audio components. Dealer installation and software updates are required.



B. BOOM! AUDIO STAGE II SPEAKER KIT – BATWING FAIRING



B. BOOM! AUDIO STAGE II SPEAKER KIT – ROAD GLIDE FAIRING



*NOTE: '14-'16 models with Boom! Audio Stage II systems with 6 or 8 speakers require installation of High-Output Charging System P/N 29900028A.

Model Family Fitment:

- V-ROD
- SPORTSTER
- DYNA
- SOFTAIL
- TOURING

Notice: The prices appearing in this catalog are the manufacturer's suggested retail prices. Actual retail prices may vary.

668 AUDIO & GAUGES

Boom!™ Audio – Stage II

A. BOOM!™ AUDIO STAGE II SPEAKER KIT – SADDLEBAGS*

Directionally optimized to fill the rider cockpit with sound, these 5" x 7" Stage II Saddlebag Lid Speakers provide additional depth and dimension to your rolling concert hall. Designed for increased volume, sound quality and durability, these three-way speakers feature a long-throw woofer to handle the low frequencies, and separate bridge mounted mid- and high-frequency drivers to handle the vocals and the high notes. And, like high-end audiophile components, each speaker is powered by two channels from our 300 watt RMS amplifier – one channel powers the woofer, and another powers the mid-range and tweeter combo. Because the speakers are driven by dedicated bass and high-frequency amplifier channels, you get thumping bass response, sizzling vocals and clean distortion free performance at all volume levels. To really pump up the bass, the closed saddlebags serve as a sealed enclosure. Built with composite speaker frames, powerful magnets and protective perforated metal grills, these weather and vibration resistant speakers are designed for life on the road. Complete kit includes 2 three-way speakers, grills and plug-in connections. Boom!™ Audio speakers feature a two-year warranty.

76000319A **\$499.95**

Fits '14-later FLHTCU, FLHTCUL, FLHTK, FLHTKL, FLHTKSE, FLHX, FLHXSE, FLTRU, FLTRX, FLTRXS and FLTRUSE models. Stock on '15-later FLHXSE and '18-later FLTRXSE models. Requires separate purchase of Color-Matched Saddlebag Lids, Boom! Amplifier and appropriate Stage II Speaker Installation Kit. Not compatible with models equipped with Stage I Boom! Audio components. Dealer installation and software updates are required.



A. BOOM! AUDIO STAGE II SPEAKER KIT – SADDLEBAGS



A. BOOM! AUDIO STAGE II SPEAKER KIT – SADDLEBAGS

B. BOOM! AUDIO STAGE I/II FAIRING LOWER SPEAKER KIT – TWIN-COOLED™ MODELS*

Designed for installation in the Original Equipment fairing lowers of Twin-Cooled™ Touring models, these vibration-tested waterproof two-way speakers feature rider directed tweeters for clear, crisp sound. The 4" bass/midrange driver and the grill-mounted 1" tweeter are performance-optimized to complement the sound characteristics of both Stage I and Stage II Boom! Audio systems, and provide higher listening volumes with reduced distortion at highway speeds. For easy installation, the speakers are pre-mounted to a backing plate that snaps in place, replacing the fairing lower cooling system access doors. The speakers can be easily removed to check coolant levels. Complete kit includes left and right two-way speakers and wiring harness. Boom! Audio speakers feature a two-year warranty.

76000660 **\$299.95**

Fits '14-later FLHTCU-TC, FLHTK, FLHTKL, FLHTKSE, FLTRU, FLTRUSE and '14-'17 FLHXSE models with Twin-Cooled engines. Use on vehicles equipped with Stage II Boom! Audio systems requires the separate purchase of Boom! Audio Amplifier Kit P/N 76000277B and Speaker Installation Kit P/N 76000586 or 76000749. FLHXSE models require separate purchase of Installation Kit P/N 76000734. Does not fit FLHXSE models equipped with Tour-Pak luggage. Does not fit FLHTKSE models equipped with Boom! Audio Stage II. Not compatible with Screamin' Eagle® Heavy Breather Kits.

Also available:

BOOM! AUDIO STAGE I/II FAIRING LOWER SPEAKER INSTALLATION KIT

Kit includes wiring harness required for installation of Boom! Audio Fairing Lower Speaker Kit P/N 76000660 on '14-'17 CVO™ Street Glide® models.

76000734 **\$29.95**

Fits '14-'17 FLHXSE models.



B. BOOM! AUDIO STAGE I/II FAIRING LOWER SPEAKER KIT – TWIN-COOLED MODELS



B. BOOM! AUDIO STAGE I/II FAIRING LOWER SPEAKER KIT – TWIN-COOLED MODELS

*NOTE: '14-'16 models with Boom! Audio Stage II systems with 6 or 8 speakers require installation of High-Output Charging System P/N 29900028A.

Model Family Fitment:

- V-ROD
- SPORTSTER
- DYNA
- SOFTAIL
- TOURING

Notice: The prices appearing in this catalog are the manufacturer's suggested retail prices. Actual retail prices may vary.

AUDIO & GAUGES 669

Boom!™ Audio – Stage II



C. BOOM! AUDIO STAGE II SPEAKER KIT – FAIRING LOWER



C. BOOM!™ AUDIO STAGE II SPEAKER KIT – FAIRING LOWER*

Nestled in the glove boxes of the vented fairing lowers, these 6.5" Stage II speakers are angled toward the rider to provide a wall of sound. Designed for increased volume, sound quality and durability, these Stage II 3-way speakers feature a long-throw woofer for resounding bass, and a bridge mounted mid-range and a separate tweeter to cover the vocals and high frequencies. Each speaker is powered by two channels from our 300 watt RMS amplifier – one channel powers the woofer, and another powers the mid/tweeter combo. When powered by separate dedicated bass and high-frequency amplifier channels, you get double the power to each speaker (when compared to a Boom!™ Audio Stage I system) for higher volume and lower distortion. A molded tray fits tightly into the fairing lower and forms a sound-optimized ported speaker enclosure for improved bass performance. Complete kit includes 2 three-way speakers, fairing lower speaker trays, grilles and plug-in connections. Boom! Audio speakers feature a two-year warranty.

76000353A \$399.95

Fits '14-later FLHTCU, FLHTCUL, FLHX, FLHXS, FLTRX, FLTRXS and FLTRXSE models equipped with fairing lowers. Does not fit models with Twin-Cooled™ engines. Requires separate purchase of Color-Matched Fairing Lower Speaker Boxes, Boom! Amplifier and appropriate Stage II Speaker Installation Kit. Not compatible with models equipped with Stage I Boom! Audio components. Dealer installation and software updates are required.



D. BOOM! AUDIO STAGE II SPEAKER KIT – TOUR-PAK AND TRI GLIDE TRIKE BODY



D. BOOM!™ AUDIO STAGE II SPEAKER KIT – TOUR-PAK® AND TRI GLIDE® TRIKE BODY*

Designed for increased volume, sound quality and durability, Stage II 6.5" Tour-Pak® and Trike Body Speakers feature a long-throw woofer for low frequencies, a bridge-mounted mid-frequency driver and a separate tweeter for high frequencies. Like true audiophile components, each speaker is powered by two channels from our 300 watt RMS amplifier – one channel powers the woofer, and another powers the mid/tweeter combo. When powered by separate dedicated bass and high-frequency amplifier channels, you are doubling the power to each speaker when compared to our Boom! Audio Stage I system. The results? You get thumping bass response, sizzling vocals and clean, distortion-free performance at all volume levels. Built with composite speaker frames, powerful magnets and protective perforated metal grilles, these weather- and vibration-resistant speakers are designed for life on the road. Complete kit includes 2 three-way speakers, grilles and plug-in connections. Boom! Audio speakers feature a two-year warranty.

76000526A \$329.95

Fits '14-later FLHTCU, FLHTCUL, FLHTK, FLHTKL, FLHTKSE, FLTRU, FLTRUSE and FLHTCUTG models. Also fits FLHX, FLHXS, FLHXSE, FLTRX, FLTRXS and FLTRXSE models equipped with a King Tour-Pak, rigid Tour-Pak mounting rack and Rear Speaker Enclosure Kit P/N 76000505. Does not fit models with H-D® Detachables™ Tour-Pak Mounting Rack. Requires separate purchase of Boom! Audio amplifier and appropriate Stage II Speaker Installation Kit. Not compatible with models equipped with Stage I Boom! Audio components. Dealer installation and software updates are required.



E. COLOR-MATCHED FAIRING LOWER SPEAKER BOXES



F. COLOR-MATCHED SADDLEBAG SPEAKER LIDS

E. COLOR-MATCHED FAIRING LOWER SPEAKER BOXES

Fits '14-later Touring models equipped with vented fairing lowers and Boom! Audio Fairing Lower Speaker Kit P/N 76000487. Does not fit models with Twin-Cooled engines.

See page 795 for complete list of available Color-Matched options.

F. COLOR-MATCHED SADDLEBAG SPEAKER LIDS

Fits '14-later Touring models equipped with Boom! Audio Saddlebag Speaker Kit P/N 76000489.

See page 795 for complete list of available Color-Matched options.

*NOTE: '14-'16 models with Boom! Audio Stage II systems with 6 or 8 speakers require installation of High-Output Charging System P/N 29900028A.

Notice: The prices appearing in this catalog are the manufacturer's suggested retail prices. Actual retail prices may vary.

670 AUDIO & GAUGES

Boom!™ Audio – Stage II

A. BOOM!™ AUDIO STAGE II SPEAKER INSTALLATION KIT – FAIRING LOWERS

Kit includes the hardware and wiring harnesses required to install Stage II Fairing Lower Speakers and a Boom!™ Amplifier. Kit includes main wiring harness, quick-disconnect saddlebag wiring harnesses, mount and cover for saddlebag-mounted amplifier, and all required hardware. Amplifier, Boom Stage II Speakers and Color-Matched Speaker Boxes are sold separately.

Fits FLHTCU, FLHTCUL, FLHTK, FLHTKL, FLHX, FLXSE, FLTRU, FLTRUSE, FLTRX and FLTRXS models equipped with fairing lowers. Not compatible with models equipped with Stage I Boom! Audio components.

76000749	Fits '17-later models.	\$299.95
76000586	Fits '14-'16 models.	\$299.95



A. BOOM! AUDIO STAGE II SPEAKER INSTALLATION KIT – FAIRING LOWERS



B. BOOM! AUDIO STAGE II SPEAKER INSTALLATION KIT – SADDLEBAG

B. BOOM!™ AUDIO STAGE II SPEAKER INSTALLATION KIT – SADDLEBAG

Kit includes the hardware and wiring harnesses required to install Stage II Saddlebag Speakers and a Boom! Amplifier. Kit includes main wiring harness, quick-disconnect saddlebag wiring harnesses, mount and cover for saddlebag-mounted amplifier, and all required hardware. Amplifier, Boom! Stage II Speakers and Color-Matched Speaker Lids are sold separately.

Fits FLHTCU, FLHTCUL, FLHTK, FLHTKL, FLHTKSE, FLHX, FLXSE, FLTRU, FLTRX, FLTRXS and FLTRUSE models. Requires separate purchase of Color-Matched Saddlebag Lids. Not compatible with models equipped with Stage I Boom! Audio components.

76000745	Fits '17-later models.	\$299.95
76000584	Fits '14-'16 models.	\$299.95

C. BOOM!™ AUDIO SPEAKER INSTALLATION KIT – TRIKE BODY

Add more Boom! to your Tri Glide® Trike model. This kit integrates a third set of 6.5" Boom! Audio Speakers in the kick panels of the Tri Glide model, and directs the increased sound pressure level directly at the rider and passenger. The kit includes left and right hidden speaker enclosures, speaker adapter rings, amplifier brackets, wiring harness, hardware and installation template. Amplifier and your choice of Boom! Audio Stage I or II speakers are sold separately.

Fits FLHTCUTG models. Not compatible with Passenger Armrests P/N 52400106 or Trike Saddlebags P/N 84031-11.

76000747	Fits '17-later models.	\$299.95
76000617	Fits '14-'16 models.	\$299.95



C. BOOM!™ AUDIO SPEAKER INSTALLATION KIT – TRIKE BODY

D. BOOM!™ AUDIO STAGE II SPEAKER INSTALLATION KIT – TOUR-PAK®

Kit includes the hardware and wiring harnesses required to install Stage II Tour-Pak® Speakers and a Boom! Amplifier. Kit includes main wiring harness, the brackets required to mount the amplifier, and all required hardware. Amplifier and Boom Stage II speakers are sold separately.

Fits '17-later FLHTCU, FLHTCUL, FLHTK, FLHTKL, FLHTKSE, FLTRU and FLTRUSE models. Also fits FLHX, FLXSE, FLXSE, FLTRX, and FLTRXS models equipped with a King Tour-Pak®, rigid Tour-Pak mounting rack and Boom! Audio Rear Speaker Enclosure Kit P/N 76000505. FLXSE models require purchase of Audio Input Harness P/N 69201477. '18-later FLHTKSE requires separate purchase of Speaker Interconnect Harness P/N 69201930 and Rear Speaker Jumper Harness P/N 69200489. '17 FLHTKSE and FLTRUSE models require purchase of Speaker Interconnect Harness P/N 69200714 and Rear Speaker Jumper Harness P/N 69200489. Not compatible with models equipped with Stage I Boom! Audio components. Does not fit models with H-D® Detachables™ Tour-Pak Mounting Rack.

76000751	Fits '17-later models.	\$249.95
76000585	Fits '14-'16 models.	\$249.95

Fits FLHTCUTG models. Not compatible with models equipped with Stage I Boom! Audio components.

76000746	Fits '17-later models.	\$249.95
76000618	Fits '14-'16 models.	\$249.95



D. BOOM!™ AUDIO STAGE II SPEAKER INSTALLATION KIT – TOUR-PAK (76000585 SHOWN)



D. BOOM!™ AUDIO STAGE II SPEAKER INSTALLATION KIT – TOUR-PAK (76000618 SHOWN)

Notice: The prices appearing in this catalog are the manufacturer's suggested retail prices. Actual retail prices may vary.



E. BOOM! BOX GTS RADIO KIT

NEW

AUDIO & GAUGES 671

Boom!™ Audio – '14-later Touring

E. BOOM!™ BOX GTS RADIO KIT

Equipped with a lightning fast processor for quick start up and route calculation and with even more memory than previous Boom! Infotainment Systems, the new Boom!™ Box GTS Infotainment System is an evolved interface experience. Available for riders of select Touring model motorcycles, the Boom! Box GTS Radio offers a contemporary look and feel while offering the latest mobile devices and tablet functionality but with durability and features designed specifically for motorcycling. Every element has been optimized to enhance the rider's interaction with the motorcycle and connectivity with the world to ultimately improve the Touring experience. The entire GTS system can be managed from the motorcycle hand controls. It's 6.5" GTS touchscreen is the same size as the 6.5 GT screen but all mechanical buttons and the plastic bezel are eliminated, providing a flatscreen. The durable touchscreen glass performs even when used with touchscreen gloves and offers the lowest reflectivity available with minimal sun washout for exceptional visibility in all situations.

76000829 Batwing Fairing. **\$1,899.95**
Fits '19-later FLHTCU and FLHX models with a 4.3 Boom!
Box Radio.

76000834 Road Glide® Fairing. **\$1,899.95**
Fits '19-later Road Glide models with a 4.3 Boom! Box Radio.

F. BOOM! BOX 6.5GT RADIO KIT

The Boom! Box 6.5 GT Infotainment System is the ideal upgrade for Touring models equipped with the standard Boom! Box 4.3 radio. One look at the brilliant 6.5" display and you know that this is something special. Boom! Box 6.5GT features a low distortion 25-watt/channel amplifier that has been optimized for great sound in an open-air environment. The result is cleaner, sharper sound at volumes up to 25% louder than previous Original Equipment radios. Built-in automatic volume control compensates for the increased noise levels as speed increases and automatically adjusts the bass and treble for optimal performance.

The feature-packed radio is factory-equipped with AM/FM radio, weather alert, integrated iPod® and USB audio device playback, map-based GPS navigation and Bluetooth® pairing of mobile phones. The 6.5GT features can be accessed via the glove-friendly touchscreen, joystick hand controls or with hands-free voice recognition. And it doesn't stop there. Optional Bike-to-Bike communication, SiriusXM® satellite radio, XM weather and traffic services and other features are also available.

For a complete rundown of the entire list of Boom! Box 6.5GT features, visit www.H-D.com/infotainment

Fits '14-'18 Touring models with the Boom! Box 4.3 audio system.

76000511 Domestic. **\$1,699.95**

76000512 Europe. **\$1,699.95**

76000232 Rest of the world. **\$1,699.95**



F. BOOM! BOX 6.5GT RADIO KIT

AUDIO & GAUGES

BOOM!™ BOX SOFTWARE UPDATE CENTER

Get the latest software for your Boom!™ Box Infotainment System here. Each highly recommended update improves the quality of the system, keeping it running at maximum effectiveness. Start by logging on to www.H-D.com/infotainment

Simply review the list, select your infotainment model number, download the file to a USB memory stick. Then insert it in your Boom! Box Infotainment System's USB port and follow the onscreen instructions to update your system.

Model Family Fitment:

V-ROD
 SPORTSTER
 DYNA

SOFTAIL
 TOURING

Notice: The prices appearing in this catalog are the manufacturer's suggested retail prices. Actual retail prices may vary.

672 AUDIO & GAUGES

Boom!™ Audio – '14-later Touring

A. SIRIUSXM® SATELLITE RADIO KIT

Don't lose the radio reception in the middle of your favorite song. SiriusXM® Satellite Radio is one of the most popular add-ons for Touring models, and it allows you to listen to the same channel as you cross the country. With over 200 digital channels, you'll always find a program that satisfies your taste for music, news, entertainment and sports. The module also provides a 25% increase in data transfer bandwidth to support weather, traffic and future data services. Your radio display provides information regarding artist name, song title and channel information so you will always know what program you are listening to. Channel presets allow you to quickly access your favorite programming. Activation and monthly subscription service required with additional fee.

76000351 **\$399.95**
Fits '14-'18 Touring and Tri Glide® models equipped with Boom!™ Box 6.5 audio system.

76000842 **\$399.95**
Fits '19-later Touring and Tri-Glide models equipped with a Boom! Box GTS infotainment system.



A. SIRIUSXM SATELLITE RADIO KIT (76000842 SHOWN)



A. SIRIUSXM SATELLITE RADIO KIT (76000351 SHOWN)

B. MUSIC AND COMMUNICATIONS KIT

Add rider headphone-access to music and helmet microphone activation of voice recognition and hands-free phone features of the Boom! Box Radio. Plug-in wiring harness allows rider to connect a standard 7-pin DIN communications headset to the radio to maximize the use of the infotainment system's convenience features. Discrete tank port accepts 7-pin plugs for rider. Works with Boom! Audio full- and half-helmet music and communication headsets. Kit includes wiring harness, rider plug-in ports, weatherproof under seat port cover and all necessary mounting hardware.

69200865 **\$69.95**
Fits '14-later FLHX and FLHXS and '15-later FLTRX and FLTRXS models (except models set up for wireless headsets). Dealer Digital Technician™ software update is required.



B. MUSIC AND COMMUNICATIONS KIT



C. BIKE-TO-BIKE COMMUNICATIONS KIT

C. BIKE-TO-BIKE COMMUNICATIONS KIT

Communicate with your friends on any of 40 channels. Easy to use handlebar controls allow Push-To-Talk (PTT) and adjustable squelch levels for maximum performance and reception quality. Integrated CB System will mute the radio while in transmit or receive mode. Bike-to-Bike system allows you and your passenger to talk with other riders, even when you are miles apart.

76000486A **\$334.95**
Fits '14-later FLHTCU, FLHTCUL, FLHTK, FLHTKL, FLTRU and FLHTCUTG models with a Boom! Box audio system. Requires separate purchase of Shorty CB Antenna P/N 76386-09A or Whip Antenna 76250-09 and Mounting Stud P/N 76000166. Also requires Push-To-Talk Button in Switch Pack P/N 71500130. Dealer Digital Technician software update is required.

D. 3.5MM AUXILIARY INPUT KIT

Add additional music and information source options to your Boom! Box-equipped Harley-Davidson® model. Harness enables GPS units, phones and music players equipped with a 3.5mm mini plug to feed their signal directly to the Boom! Box receiver. Harness length permits running cable to fairing-mounted Jukebox door or glove compartment or behind fairing to a GPS mount.

69200907 **\$39.95**
Fits '14-later Electra Glide®, Road Glide®, Street Glide®, Ultra Limited and Tri Glide models.



D. 3.5MM AUXILIARY INPUT KIT

BOOM!™ BOX SOFTWARE UPDATE CENTER

Get the latest software for your Boom! Box Infotainment System here. Each highly recommended update improves the quality of the system, keeping it running at maximum effectiveness. Start by logging on to www.H-D.com/infotainment

Simply review the list, select your infotainment model number, download the file to a USB memory stick. Then insert it in your Boom! Box Infotainment System's USB port and follow the onscreen instructions to update your system.

Model Family Fitment:

- V-ROD
- SPORTSTER
- DYNA
- SOFTAIL
- TOURING

Notice: The prices appearing in this catalog are the manufacturer's suggested retail prices. Actual retail prices may vary.

BOOM!™ AUDIO 2006–2013 TOURING

Harley-Davidson® Boom!™ Audio is an exciting collection of integrated audio components designed to combine the maximum number of features with an easy-to-use interface. And because your bike's Advanced Audio Radio is designed for plug-and-play integration of Boom! Audio equipment, you can easily create the custom sound experience you've always wanted.



FAIRING SPEAKERS

Capture every note. Designed for maximum performance in the harsh motorcycle environment, these waterproof two-way speakers feature increased sensitivity for 25% louder output, reduced distortion and improved clarity at speed.



AMPLIFIERS

When loud just isn't loud enough. Rugged Fairing, Tour-Pak® and Saddlebag-mounted amplifiers provide increased volume, lower distortion, reduced clipping and fuller sound that cuts through wind and road noise.



IPOD® INTERFACE

Access your iPod® playlists, artists, songs and albums while you keep your hands on the handlebar. At the touch of your fingertips, you can use the factory audio hand controls to scan through the iPod menus and view the selections on the radio face.



FAIRING LOWER SPEAKERS

Nestled into the glove boxes of your vented fairing lowers, these vibration-tested waterproof two-way speakers feature rider directed tweeters for clear, crisp sound.



BASS BOOST PORTS

Boost bass response without adding a subwoofer. The open ports permit the rear speaker pods to "breathe," using the Tour-Pak air space for a 21% increase in bass response and an 82% reduction in distortion.



SADDLEBAG LID SPEAKERS

Directionally optimized for improved rider acoustics, these waterproof 5" x 7" two-way speakers turn the latched and gasket-sealed saddlebags into large speaker enclosures for enhanced bass response.



BIKE-TO-BIKE COMMUNICATIONS KIT

Bike-to-Bike system allows you and your passenger to talk with other riders, even when you are miles apart. Integrated CB features easy to use handlebar controls and will mute the radio while in transmit or receive mode.

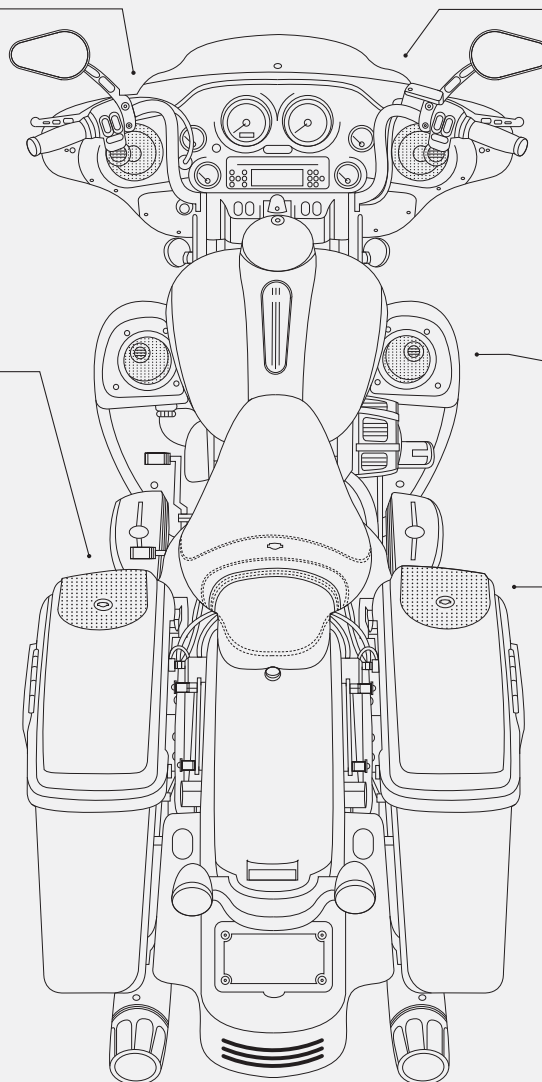

TOUR-PAK® SPEAKER PODS

Surround yourself with sound. Forward-facing two-way speakers feature waterproof grill-mounted tweeters and injection-molded woofer cones with high-flux Neodymium magnets and are sized to be a direct replacement for the factory speakers.

2013 STREET GLIDE® SHOWN

674 AUDIO & GAUGES

Boom!™ Audio – '06-'13 Touring

BOOM!™ AUDIO PREMIUM SOUND OPTIONS

The Boom!™ Audio system is an exciting collection of audio and information components that turn your 2006 – 2013 Touring motorcycle into a rolling infotainment center. Designed for ease of use, this line of premium speakers, amplifiers and audio upgrades integrate with the factory-installed radio and hand controls for seamless operation.

See the table below to view the Boom! Audio options. Your Dealer will be happy to recommend system-matched components for your model and provide the installation expertise that your Harley® motorcycle deserves.



For the latest information, visit h-d.com/boomaudio.

'06-'13 ELECTRA GLIDE®/STREET GLIDE® MODELS

Part Number	Description	FLHT (with Radio)	FLHT (with Radio & Tour-Pak)	FLHX	FLHX (with Tour-Pak)	FLHTC	FLHTCU	FLHTK
76000070	Amplifier, Fairing Mount (Batwing)	69200106	NO FIT	69200106	NO FIT	NO FIT	N/A	N/A
76000169	Amplifier, Fairing Mount (Road Glide®)	NO FIT	NO FIT	NO FIT	NO FIT	NO FIT	NO FIT	NO FIT
76000068	Amplifier, Tour-Pak® Mount	N/A	70169-06A	N/A	70169-06A	70169-06A	OK	OK
76000209	Custom Touring Audio System	OK	NO FIT	OK	NO FIT	NO FIT	NO FIT	NO FIT
76000051	Ultra Boom! Bagger Kit	N/A	70169-06A	N/A	70169-06A	70169-06A	OK	OK
76000074	Street Glide® Boom! Bagger Kit	69200106	NO FIT	69200106	NO FIT	NO FIT	N/A	N/A
76000050	Fairing Lower Speakers	69200106	69200106	69200106	69200106	69200106	76000263	76000263
76000021	Rear Speaker Pods	N/A	69200106	N/A	69200106	69200106	STOCK	STOCK
76000202	Saddlebag Lid Speakers	69200106	69200106	69200106	69200106	69200106	76000263	76000263
76000263	Speaker Expansion Kit	OK	OK	OK	OK	OK	OK	OK
76000275	CVO™ Speaker Expansion Kit	NO FIT	NO FIT	NO FIT	NO FIT	NO FIT	NO FIT	NO FIT
76476-10	iPod® Interface Kit	69200033	69200033	69200033	69200033	69200033	OK	OK
76000024	Navigation Interface Module	69200033	69200033	69200033	69200033	69200033	OK	OK
76404-06	SiriusXM® Satellite Radio Kit	70169-06A	70169-06A	70169-06A	70169-06A	70169-06A	70172-06	70172-06
77173-08	Audio Communication Switch Kit	70169-06A	70169-06A	70169-06A	70169-06A	70169-06A	STOCK	STOCK
76000390	B2B Communication Kit	70169-06A	70169-06A	70169-06A	70169-06A	70169-06A	STOCK	STOCK
77107-09	Music & Intercom Kit	OK	OK	OK	OK	OK	N/A	N/A
77108-09	Music & Intercom Kit (B2B Feature)	70169-06A	70169-06A	70169-06A	70169-06A	70169-06A	N/A	N/A
76440-06	Music & Intercom Kit (Tour-Pak)	N/A	70169-06A	N/A	70169-06A	70169-06A	STOCK	STOCK

'06-'13 ROAD GLIDE® MODELS

'09-'13 TRIKE

Part Number	Description	FLTR	FLTR (with Tour-Pak)	FLTRX	FLTRX (with Tour-Pak)	FLTRU	FLHXXX	FLHTCUTG
76000070	Amplifier, Fairing Mount (Batwing)	NO FIT	NO FIT	NO FIT	NO FIT	NO FIT	69200106	N/A
76000169	Amplifier, Fairing Mount (Road Glide)	69200106	69200106	69200106	69200106	OK	NO FIT	NO FIT
76000068	Amplifier, Tour-Pak Mount	N/A	70169-06A	N/A	70169-06A	OK	N/A	OK
76000209	Custom Touring Audio System	NO FIT	NO FIT	NO FIT	NO FIT	NO FIT	NO FIT	NO FIT
76000051	Ultra Boom! Bagger Kit	N/A	70169-06A	N/A	70169-06A	OK	N/A	OK
76000074	Street Glide Boom! Bagger Kit	NO FIT	NO FIT	NO FIT	NO FIT	NO FIT	69200106	N/A
76000050	Fairing Lower Speakers	NO FIT	69200106	69200106	69200106	76000263	69200106	76000263
76000021	Rear Speaker Pods	N/A	69200106	N/A	69200106	STOCK	N/A	STOCK
76000202	Saddlebag Lid Speakers	69200106	69200106	69200106	69200106	76000263	NO FIT	NO FIT
76000263	Speaker Expansion Kit	OK	NO FIT	OK	OK	OK	OK	OK
76000275	CVO Speaker Expansion Kit	NO FIT	NO FIT	NO FIT	NO FIT	NO FIT	NO FIT	NO FIT
76476-10	iPod Interface Kit	69200033	69200033	69200033	69200033	OK	69200033	OK
76000024	Navigation Interface Module	69200033	69200033	69200033	69200033	OK	69200033	OK
76404-06	SiriusXM Satellite Radio Kit	70169-06A	70169-06A	70169-06A	70169-06A	70172-06	70169-06A	70172-06
77173-08	Audio Communication Switch Kit	70169-06A	70169-06A	NO FIT	NO FIT	STOCK	70169-06A	STOCK
76000390	B2B Communication Kit	70169-06A	70169-06A	NO FIT	70169-06A	STOCK	NO FIT	STOCK
77107-09	Music & Intercom Kit	OK	OK	NO FIT	NO FIT	N/A	OK	N/A
77108-09	Music & Intercom Kit (B2B Feature)	70169-06A	70169-06A	NO FIT	NO FIT	N/A	70169-06A	N/A
76440-06	Music & Intercom Kit (Tour-Pak)	N/A	70169-06A	N/A	70169-06A	STOCK	N/A	STOCK

CVO™ STREET GLIDE®

CVO ELECTRA GLIDE® ULTRA

Part Number	Description	CVO 2010 CVO 2011 CVO 2012 CVO '06-'10 CVO 2011 CVO 2012 CVO 2013							
		FLHXSE	FLHXSE2	FLHXSE3	FLHTCUSE	FLHTCUSE6	FLHTCUSE7	FLHTCUSE8	
76000070	Amplifier, Fairing Mount (Batwing)	69200106	NO FIT	NO FIT	N/A	NO FIT	NO FIT	NO FIT	
76000169	Amplifier, Fairing Mount (Road Glide®)	NO FIT	NO FIT	NO FIT	NO FIT	NO FIT	NO FIT	NO FIT	
76000068	Amplifier, Tour-Pak® Mount	N/A	NO FIT	NO FIT	STOCK	STOCK	STOCK	STOCK	
76000209	Custom Touring Audio System	OK	NO FIT	STOCK	NO FIT	NO FIT	NO FIT	NO FIT	
76000051	Ultra Boom!™ Bagger Kit	N/A	NO FIT	NO FIT	N/A	N/A	STOCK	STOCK	
76000074	Street Glide® Boom! Bagger Kit	69200106	NO FIT	NO FIT	N/A	NO FIT	NO FIT	NO FIT	
76000050	Fairing Lower Speakers	69200106	N/A	N/A	76000263	76000263	76000263	76000263	
76000021	Rear Speaker Pods	N/A	NO FIT	NO FIT	N/A	N/A	STOCK	STOCK	
76000202	Saddlebag Lid Speakers	69200106	NO FIT	N/A	76000263	76000275	76000263	76000263	
76000263	Speaker Expansion Kit	OK	NO FIT	NO FIT	OK	OK	OK	OK	
76000275	CVO™ Speaker Expansion Kit	NO FIT	OK	STOCK	NO FIT	NO FIT	NO FIT	NO FIT	
76476-10	iPod® Interface Kit	69200033	STOCK	STOCK	OK	NO FIT	STOCK	STOCK	
76000024	Navigation Interface Module	69200033	76000275	NO FIT	OK	NO FIT	STOCK	STOCK	
76404-06	SiriusXM® Satellite Radio Kit	70169-06A	76000275	NO FIT	STOCK	STOCK	STOCK	STOCK	
77173-08	Audio Communication Switch Kit	70169-06A	NO FIT	NO FIT	STOCK	STOCK	STOCK	STOCK	
76000390	B2B Communication Kit	70169-06A	NO FIT	NO FIT	STOCK	STOCK	STOCK	STOCK	
77107-09	Music & Intercom Kit	OK	NO FIT	NO FIT	STOCK	NO FIT	NO FIT	NO FIT	
77108-09	Music & Intercom Kit (B2B Feature)	70169-06A	NO FIT	NO FIT	STOCK	NO FIT	NO FIT	NO FIT	
76440-06	Music & Intercom Kit (Tour-Pak)	N/A	NO FIT	NO FIT	STOCK	STOCK	STOCK	STOCK	

AUDIO & GAUGES

CVO ROAD GLIDE®

CVO ROAD KING®

Part Number	Description	CVO 2009 CVO 2011 CVO 2012 CVO 2013				CVO 2013
		FLTRSE	FLTRUSE	FLTRXSE	FLTRXSE2	
76000070	Amplifier, Fairing Mount (Batwing)	69200106	NO FIT	NO FIT	NO FIT	NO FIT
76000169	Amplifier, Fairing Mount (Road Glide)	NO FIT	NO FIT	NO FIT	NO FIT	NO FIT
76000068	Amplifier, Tour-Pak Mount	N/A	STOCK	NO FIT	NO FIT	NO FIT
76000209	Custom Touring Audio System	NO FIT	NO FIT	NO FIT	STOCK	NO FIT
76000051	Ultra Boom! Bagger Kit	N/A	N/A	NO FIT	NO FIT	NO FIT
76000074	Street Glide Boom! Bagger Kit	69200106	NO FIT	NO FIT	NO FIT	NO FIT
76000050	Fairing Lower Speakers	69200106	76000263	N/A	N/A	N/A
76000021	Rear Speaker Pods	N/A	STOCK	NO FIT	NO FIT	NO FIT
76000202	Saddlebag Lid Speakers	69200106	76000275	N/A	N/A	N/A
76000263	Speaker Expansion Kit	OK	OK	NO FIT	NO FIT	NO FIT
76000275	CVO Speaker Expansion Kit	NO FIT	NO FIT	OK	STOCK	NO FIT
76476-10	iPod Interface Kit	69200033	STOCK	STOCK	STOCK	NO FIT
76000024	Navigation Interface Module	69200033	STOCK	76000275	NO FIT	NO FIT
76404-06	SiriusXM Satellite Radio Kit	70169-06A	STOCK	76000275	NO FIT	NO FIT
77173-08	Audio Communication Switch Kit	70169-06A	STOCK	NO FIT	NO FIT	NO FIT
76000390	B2B Communication Kit	70169-06A	STOCK	NO FIT	NO FIT	NO FIT
77107-09	Music & Intercom Kit	OK	NO FIT	NO FIT	NO FIT	NO FIT
77108-09	Music & Intercom Kit (B2B Feature)	70169-06A	NO FIT	NO FIT	NO FIT	NO FIT
76440-06	Music & Intercom Kit (Tour-Pak)	N/A	STOCK	NO FIT	NO FIT	NO FIT

KEY

N/A	Not applicable. Stock or requires substitution or separate purchase.
OK	Ready to install. No additional harness purchase required.
NO FIT	Will not fit. Not for use with model.
70169-06A	Harness required. Permits multiple audio accessory combinations and allows any or all of the following: SiriusXM, Bike-to-Bike Communications, additional speakers, Tour-Pak amplifier, iPod Interface, Navigation Interface, headsets and Communications Kit.
69200106	Harness required. Permits installation of Fairing Amplifier and additional speakers (Fairing Lower, Saddlebag Lid or Tour-Pak Pod speakers). Also allows installation of iPod Interface and/or Navigation Interface. **If installing any other audio accessories in addition to those listed above with Tour-Pak Amplifier, use Harness P/N 70169-06A. See matrix for details.
69200033	Harness required. Permits installation of iPod Interface and/or Navigation Interface ONLY on models not previously equipped with other Audio Accessories. *If installing additional audio accessories with iPod Interface and/or Navigation Interface, use Harness P/N 70169-06A or 69200106. See matrix for details.
70172-06	Harness required. Permits installation of SiriusXM module ONLY on FLHTCU, FLHTK and FLTRU models. Uses CB connector.
76000263	Speaker Expansion Kit required. Permits installation of 3rd and 4th pair of speakers.
76000275	CVO Speaker Expansion Kit required. Permits installation of SiriusXM module and/or Navigation Interface on specified CVO models.

676 AUDIO & GAUGES

Boom!™ Audio – '06-'13 Touring

A. BOOM!™ AUDIO AMPLIFIER KITS

Take your music to the streets. Boom!™ Audio Amplifier Kits allow you to crank up the volume with significantly less distortion. The amplifier provides more power than Original Equipment radio alone, resulting in increased volume, fuller sound reproduction, reduced clipping and lower Total Harmonic Distortion (THD) than head unit alone. When teamed with Boom! Audio Speakers, the Boom! Amplifier provides 50% louder (6dB) system output than other popular aftermarket systems at the same volume setting. The system-matched high-output signal features optimized sound equalization for crisp, clear vocals and maximum bass response and the strong midrange response cuts through wind and road noise. The amplifier features 40-watt/channel (160-watt total) output. Kit includes all mounting hardware.

76000070 Fairing Amp. **\$409.95**

Fits '06-'09 FLHT, '06-'13 FLHX and '10 FLHXSE models. Not for use with SiriusXM® Satellite Radio Kit P/N 76404-06, Bike-to-Bike Communication Kit P/N 76416-06C or Tour-Pak® luggage. Requires separate purchase of appropriate Wiring Harness. Models equipped with iPod® Interface P/N 76476-10 require separate purchase of iPod Relocation Kit P/N 76000238. Dealer Digital Technician™ software update is required. Dealer installation is recommended.

76000169 Fairing Amp. **\$409.95**

Fits '06-'13 Road Glide® models (except FLTRUSE and FLTRXSE). All models (except FLTRU) require separate purchase of appropriate Wiring Harness. Dealer Digital Technician software update is required. Dealer installation is recommended.

76000068 Tour-Pak® Amp. **\$409.95**

Fits '06-'13 Touring models (except FLTRUSE and FLTRXSE) equipped with an Advanced Audio Radio and rigid-mount Tour-Pak luggage system. Requires installation of appropriate Wiring Harness. Dealer Digital Technician software update is required. Dealer installation is recommended.

B. BOOM!™ AUDIO SPEAKER EXPANSION KIT

Add more Boom! to your bike. This kit permits the addition of a third and fourth pair of speakers to your Boom! Audio-equipped Touring bike. Choose a combination of Boom! Audio Saddlebag Lid Speakers, Fairing Lower Speakers and/or Rear Speaker Pods (sold separately) to build a sound system custom-designed to your audio demands. System also provides speaker fade capabilities between fairing and non-fairing mounted speakers for highway riding, when it's needed most. You can upgrade your system all at once or one set of speaker options at a time. Kit includes 100-watt/channel (200-watts total) saddlebag-mounted amplifier, amplifier cover, mounting bracket and the required installation hardware and wiring harness.

76000263 **\$569.95**

Fits '06-'13 Touring and Trike models (except FLTRXSE and '11-'12 FLHXSE) equipped with Advanced Audio Radio and Boom! Audio Fairing Amplifier P/N 76000070, 76000074, 76000169 or Tour-Pak Amplifier P/N 76000068. Not for use with Custom Touring System P/N 76000209. Dealer Digital Technician software update is required. Dealer installation is recommended.

NOTE: Follow fitment statements for Boom! Audio Amplifiers listed above. Fairing-Mounted Amplifiers are not for use with Tour-Pak Luggage.



A. BOOM! AUDIO FAIRING MOUNT AMPLIFIER
(76000070 SHOWN)



A. BOOM! AUDIO FAIRING MOUNT AMPLIFIER
(76000169 SHOWN)



A. BOOM! AUDIO TOUR-PAK MOUNT AMPLIFIER
(76000068 SHOWN)



B. BOOM! AUDIO SPEAKER EXPANSION KIT

Notice: The prices appearing in this catalog are the manufacturer's suggested retail prices. Actual retail prices may vary.

BOOM!™ AUDIO BOOM! BAGGER AMP & SPEAKER KITS

- Boom!™ Bagger system offers an increase in frequency response range of 12% over the popular aftermarket upgrade amplifier and speaker system and 80% over the Stock system
- Boom! Bagger system distortion is 57% lower than popular aftermarket system providing increased clarity
- Boom! Bagger system output is >50% louder (6dB) than popular aftermarket system at the same volume setting
- Strong midrange response cuts through wind and road noise
- Extended bass response for accurate, full music reproduction

Fill the air with sound from this Boom! Audio Ultra Boom! Bagger Kit. Available to fit 2- and 4-speaker equipped Electra Glide® models, this complete audio kit provides the latest in Harley-Davidson® audio components. When installed, the increased power of the amplifier provides the speakers with a clean signal and a custom equalization is available to further optimize the performance of the Boom! Audio speakers. Speakers feature two-year warranty. Dealer Digital Technician™ software update is required. Dealer installation is recommended.

C. 4-SPEAKER ULTRA BOOM! BAGGER KIT

Kit includes Boom! Audio fairing and rear speakers, the Bass Booster Port Kit and the Boom! Audio Tour-Pak®-mounted Amplifier. Boom! Audio speakers feature a two-year warranty.

76000051 **\$799.95**

Fits '06-'13 FLHTCU and FLHTK and '09-'13 FLHTCUTG models equipped with the Advanced Audio Radio. Also fits Electra Glide® and Street Glide® models equipped with Advanced Audio Radio, rigid-mount King Tour-Pak and rear speaker pods.

D. 2-SPEAKER STREET GLIDE® BOOM! BAGGER KIT

Kit includes Boom! Audio fairing speakers and Boom! Audio Fairing Mount Amplifier. Boom! Audio speakers feature a two-year warranty.

76000074 **\$579.95**

Fits '06-'09 FLHT, '06-'13 FLHX and '10 FLHXSE models. Not for use with SiriusXM® Satellite Radio Kit P/N 76404-06, Bike-to-Bike Communication Kit P/N 76416-06C or Tour-Pak luggage. Requires separate purchase of appropriate Wiring Harness. Models equipped with iPod® Interface P/N 76476-10 require separate purchase of iPod Relocation Kit P/N 76000238.

C. BOOM! AUDIO BOOM! BAGGER KIT – ULTRA 4-SPEAKER KIT



D. BOOM! AUDIO BOOM! BAGGER KIT – STREET GLIDE 2-SPEAKER KIT

Model Family Fitment:

- | | | |
|---|---|--|
| V-ROD | SPORTSTER | DYNA |
| SOFTAIL | TOURING | |

Notice: The prices appearing in this catalog are the manufacturer's suggested retail prices. Actual retail prices may vary.

678 AUDIO & GAUGES

Boom!™ Audio – '06-'13 Touring

A. BOOM!™ AUDIO HIGH PERFORMANCE BOOM! BAGGER SPEAKERS*

Capture every note. Boom!™ Bagger High Performance Speakers are designed for maximum performance in the harsh motorcycle environment. Two-way speaker design with separate full-range element and grill-mounted tweeter provides improved high-frequency response that helps cut through the road and wind noise. Increased speaker sensitivity provides louder output than Original Equipment speakers and the leading competition at the same volume setting, resulting in reduced distortion for improved clarity at speed. Vibration-tested 5.25" waterproof speakers feature injection-molded woofer cones with a high-flux Neodymium magnet and are sized to be a direct replacement for the factory speakers with no modification to the speaker housing. Complete kit includes two-way speaker design with separate custom grill-mounted tweeters, electronic crossovers and plug and play wiring connections. Boom! Audio speakers feature a two-year warranty.

Electra Glide® Fairing Speakers

77181-10 2 ohm. **\$169.95**
Fits '06-'13 Street Glide®, Electra Glide® and Trike models equipped with fairing mount speakers and Advanced Audio System radio.

76000256 8 ohm. **\$169.95**
Fits '98-'05 Electra Glide models equipped with fairing mount speakers and Original Equipment radio.

Road Glide® Fairing Speakers

77028-10 2 ohm. **\$169.95**
Fits '06-'13 Road Glide® models equipped fairing mount speakers and Advanced Audio System radio.

Tour-Pak® Rear Speakers

77037-10 2 ohm. **\$169.95**
Fits '06-'13 Touring and '09-'13 Tri Glide® models (except CVO™) equipped with Tour-Pak® mounted speakers and Advanced Audio System radio.

76000257 8 ohm. **\$169.95**
Fits '98-'05 Touring models equipped with Tour-Pak mounted speakers and Original Equipment radio.



A. BOOM! AUDIO HIGH PERFORMANCE BOOM! BAGGER FAIRING SPEAKERS – (ELECTRA GLIDE SHOWN)



A. BOOM! AUDIO HIGH PERFORMANCE BOOM! BAGGER FAIRING SPEAKERS – (ROAD GLIDE SHOWN)



A. BOOM! AUDIO HIGH PERFORMANCE BOOM! BAGGER REAR SPEAKERS

* NOTE: The H-D® Advanced Audio Radio or H-D Boom! Audio Amplifier will power up to a total of 4 speakers. A 3rd and 4th pair of speakers require the use of Speaker Expansion Kit P/N 76000263. Additional speaker options include Boom! Audio Fairing Lower Speakers, Boom! Audio Saddlebag Lid Speakers or Boom! Audio Tour-Pak® Rear Speakers.

Model Family Fitment:

- V-ROD
- SPORTSTER
- DYNA
- SOFTAIL
- TOURING

Notice: The prices appearing in this catalog are the manufacturer's suggested retail prices. Actual retail prices may vary.

AUDIO & GAUGES 679

Boom!™ Audio – '06-'13 Touring



**B. BOOM! AUDIO SADDLEBAG SPEAKER KIT
(SHOWN WITH COLOR-MATCHED SADDLEBAG SPEAKER LIDS)**



B. BOOM! AUDIO SADDLEBAG SPEAKER KIT



C. CVO SADDLEBAG SPEAKER EXPANSION KIT

B. BOOM!™ AUDIO SADDLEBAG SPEAKER KIT*

Grab the best seat in the house. Boom!™ Audio Saddlebag Speakers provide two powerful rear speakers, directed at the rider for concert sound. Saddlebag mounted speakers increase the available sound pressure level and produce higher listening volume, lower distortion and improved clarity at highway speeds. The latched and gasket-sealed saddlebag acts as a large speaker enclosure to enhance bass response. The pair of 5" x 7" waterproof 2-ohm full range speakers feature suspended 1" tweeters that are directionally optimized for improved rider acoustics. The vacuum-formed woofer cones feature high-flux Neodymium magnets for more power with less weight. Extensively tested to withstand the harshest riding conditions, the speakers fit seamlessly in custom-designed saddlebag lids (sold separately) and are covered by stylish but durable mesh speaker grills. Kit includes left and right speakers, grills, protective mounting baskets, rear wiring harness and installation hardware. Saddlebag lids and model-specific wiring harness (sold separately). Boom! Audio speakers feature a two-year warranty.

76000202 \$399.95

Fits '06-'13 Touring models (except FLTRXSE, '11-'12 FLHXSE and '13 FLTRXSE) with Advanced Audio Radio. '11 FLHXSE and '12 FLTRXSE models require separate purchase of CVO™ Speaker Expansion Kit P/N 76000275. Requires separate purchase of appropriate Saddlebag Lids and Wiring Harness. Not for use with Music and Intercom Kit P/N 77107-09, Music and Intercom Kit P/N 77108-09. Dealer Digital Technician™ software update is required. Dealer installation is recommended.

C. CVO™ SADDLEBAG SPEAKER EXPANSION KIT

Add the latest in audio performance to your CVO™ Street Glide® or Road Glide® model. This kit includes all the audio components required to equip your '11 FLHXSE and '12 FLTRXSE models with the added volume and deeper bass provided by saddlebag lid-mounted speakers. Kit includes the 100-watt/channel saddlebag-mounted amplifier and a pair of waterproof 5" x 7" saddlebag lid speakers that are perfectly matched to the Original Equipment fairing and fairing lower mounted speakers. The kit also includes speaker grills, mounting baskets, wiring harness and all installation hardware. All you need to add are color-matched saddlebag lids (sold separately).

76000275 \$999.95

Fits '11 FLHXSE and '12 FLTRXSE models with Original Equipment audio configuration. Dealer Digital Technician software update is required. Dealer installation is recommended.

Also available:

COLOR-MATCHED SADDLEBAG SPEAKER LIDS*

Custom saddlebag lids are shaped to accommodate Boom!™ Audio Saddlebag Lid Speakers. Speaker openings are formed to angle the speakers and direct the sound forward toward the rider and passenger. Lids are also available unpainted ready for your custom paint design. Kit includes saddlebag lid, lid gasket, mounting plate and striker plates and installation reuses Original Equipment hinges, locks and mounting hardware.

Fits '06-'13 Touring models equipped with Boom! Audio Saddlebag Speaker Kit P/N 76000202.

Left

90200612	Primed/Paintable.	\$169.95
90200614DH	Vivid Black.	\$239.95

Right

90200613	Primed/Paintable.	\$169.95
90200615DH	Vivid Black.	\$239.95

* NOTE: The H-D® Advanced Audio Radio or H-D Boom! Audio Amplifier will power up to a total of 4 speakers. A 3rd and 4th pair of speakers require the use of Speaker Expansion Kit P/N 76000263. Additional speaker options include Boom! Audio Fairing Lower Speakers, Boom! Audio Saddlebag Lid Speakers or Boom! Audio Tour-Pak® Rear Speakers.

Notice: The prices appearing in this catalog are the manufacturer's suggested retail prices. Actual retail prices may vary.

680 AUDIO & GAUGES

Boom!™ Audio – '06-'13 Touring

A. BOOM!™ AUDIO FAIRING LOWER SPEAKER KIT*

Drive through a wall of sound. Boom!™ Audio Fairing Lower Speakers provide two additional sound sources directed at the rider for a concert-hall sound experience. Adding fairing lower speakers to your current two-speaker system increases the available sound pressure level, permitting higher listening volume, lower distortion and improved clarity at highway speeds. The pair of 5.25" waterproof 2-ohm full range speakers feature suspended 1.0" tweeters that are directionally optimized for improved rider acoustics. The injection-molded woofer cones feature high-flux Neodymium magnets for more power with less weight. The speakers nestle into the glove box area of the available Vented Fairing Lower (sold separately), providing a combination of great sound and added weather protection. Kit includes left and right speakers, glove box mounts and installation hardware. Fairing lowers and model-specific wiring harness sold separately. Boom! Audio speakers feature a two-year warranty.

76000050 **\$249.95**

Fits '06-'13 FLHT, FLHTC, FLHTCU and FLHX, '10 FLHXSE, '11-'13 FLTRU, '10-'13 FLTRX, '09-'13 FLHTCUTG and '10-'11 FLHXXX models. Does not fit FLTRXSE, FLHTCU and FLHTCUTG models require separate purchase of Boom! Audio Speaker Expansion Kit P/N 76000263. Requires separate purchase of Color-Matched Vented Fairing Lower Kit and appropriate Wiring Harness. Does not fit models equipped with Heavy Breather Air Cleaner. Not for use with Music and Intercom Kit P/N 77107-09, Music and Intercom Kit P/N 77108-09 or Quick-Release Detachable Fairing Lower Hardware Kit P/N 58146-07. Dealer Digital Technician™ software update is required. Dealer installation is recommended.



A. BOOM! AUDIO FAIRING LOWER SPEAKER KIT

B. BOOM!™ AUDIO REAR SPEAKER POD KIT*

Add concert-hall sound to your motorcycle. Boom! Audio Rear Speaker Pod Kit includes Boom! Audio High Performance rear speakers, rear speaker pods and passenger controls for rear headset volume, CB PTT and radio tuning. For even more bass performance, add the Boom! Audio Bass Booster Tour-Pak® Port Kit P/N 76000013 (sold separately). Boom! Audio speakers feature a two-year warranty.

76000021 **\$499.95**

Fits '06-'13 Touring models (except FLTRXSE and '11-'12 FLHXSE) equipped with an Advanced Audio Radio and a rigid-mount King Tour-Pak luggage system. Requires installation of appropriate Wiring Harness. Dealer Digital Technician software update is required.



B. BOOM!™ AUDIO REAR SPEAKER POD KIT

C. BOOM!™ AUDIO BASS BOOSTER TOUR-PAK® PORT KIT

This Bass Booster Port Kit provides significant improvements in bass response without adding a subwoofer and has no impact on useable Tour-Pak carrier cargo capacity. When installed, the open port permits the speaker pod to "breathe," reducing the compression effect that limits speaker cone travel. You hear a 21% increase in bass response for better sound with a fuller bottom end and an 82% reduction in peak distortion for accurate bass reproduction. Noticeable improvement is gained with both Original Equipment and Boom! Audio High Performance Speakers. The kit contains black-anodized aluminum ports, stainless steel audio-transparent grills and unique Sound Sealing technology to give you that Boom! you were looking for.

76000013 **\$89.95**

Fits '06-'13 FLHTCU, FLHTK and FLTRU and '09-'13 FLHTCUTG models. Also fits '06-'11 FLHTCUSE models and other Touring models equipped with King Tour-Pak and Boom! Audio Rear Speaker Pod Kit. '06-'10 FLHTCUSE models require replacement of Original Equipment amplifier. Does not fit with Boom! Audio High Output Sound System P/N 76418-06 or 76418-06A. Dealer Digital Technician software update is required. Dealer installation is recommended.



C. BOOM!™ AUDIO BASS BOOSTER TOUR-PAK PORT KIT

* NOTE: The H-D® Advanced Audio Radio or H-D Boom! Audio Amplifier will power up to a total of 4 speakers. A 3rd and 4th pair of speakers require the use of Speaker Expansion Kit P/N 76000263. Additional speaker options include Boom! Audio Fairing Lower Speakers, Boom! Audio Saddlebag Lid Speakers or Boom! Audio Tour-Pak® Rear Speakers.

Notice: The prices appearing in this catalog are the manufacturer's suggested retail prices. Actual retail prices may vary.



D. IPOD INTERFACE

D. IPOD® INTERFACE

Available exclusively for models equipped with the Harley-Davidson® Advanced Audio System by Harman/Kardon®. The iPod® interface allows you to access your iPod playlists, artists, songs and albums while you keep your hands on the handlebar. At the touch of your fingertips, you can use the factory audio hand controls to scan through the iPod menus and view the selections on the radio face. The module mounts directly to the radio and is concealed inside the fairing for a clean look. Just plug in your iPod nano®, iPod Touch® or iPhone® and hit the road. Kit includes a powered iPod cable that charges your player when it is connected to the system and the bike is turned on. The iPod can be remotely stored in the saddlebag with the separate purchase of Saddlebag iPod Holder P/N 76000143.

76476-10 \$399.95
 Fits '06-'13 FLHT, FLHTC, FLHTCU, FLHTK, FLHX, FLTR, FLTRU and FLTRX, '09-'13 FLHTCUTG and '10-'11 FLHXXX models equipped with an Advanced Audio radio. Stock on select CVO™ models. Does not fit '11 CVO FLHTCUSE. '06-later FLHTC, FLHX, FLTR and FLTRX models and those not equipped with Wiring Harness P/N 70169-06 require the separate purchase of Connector Kit P/N 69200033. Models equipped with Boom!™ Audio Fairing Amplifier require installation of iPod Relocation Kit P/N 76000238.



E. SIRIUSXM SATELLITE RADIO KIT

E. SIRIUSXM® SATELLITE RADIO KIT*

Don't lose the radio reception in the middle of your favorite song. SiriusXM® Satellite Radio allows you to listen to the same channel as you cross the country. With over 170 digital channels, you'll always find a program that satisfies your taste for music, news, entertainment and sports. Your radio display provides information regarding artist name, song title and channel information so you will always know what program you are listening to. 15 channel presets allow you to quickly access your favorite programming. Activation and monthly subscription service required with additional fee.

76404-06 \$499.95
 Fits '06-'13 Touring models (except '12 FLHXSE and '13 FLTRXSE) equipped with an Advanced Audio Radio. '11 FLHXSE and '12 FLTRXSE models require separate purchase of CVO Speaker Expansion Kit P/N 76000275. Requires installation of appropriate Wiring Harness and Antenna Bracket P/N 76456-06 (FLH models) or 76316-06A (FLTR models).

F. SADDLEBAG IPOD HOLDER

Protect your iPod from the elements and keep it out of sight. Designed to complement iPod Interface-equipped models, this saddlebag-mounted iPod Holder replaces the Original Equipment saddlebag tether and suspends your iPod in a shock-reducing zippered pouch. Just route your iPod Interface Cable to the saddlebag, plug in your iPod and forget about it. You control the operation with the fingertip controls on your Advanced-Audio Radio.

76000143 \$149.95
 Fits '06-'13 Touring models equipped with Color-Matched Hard Saddlebags and the iPod Interface P/N 76476-10. Stock on select CVO models.



F. SADDLEBAG IPOD HOLDER



G. IPOD RELOCATION KIT

G. IPOD RELOCATION KIT

Create room inside your fairing for a Boom! Audio Amplifier or additional Advanced Audio radio modules by relocating the iPod Interface Module to the saddlebag. Kit includes saddlebag mounting bracket, module cover and all necessary wiring.

76000238 \$229.95
 Fits '06-'13 FLHT, FLHTC, FLHTCU, FLHTK, FLHX, FLTR, FLTRU and FLTRX models equipped with iPod Interface P/N 76476-10 and a Boom! Audio Fairing Amplifier. Does not fit '12-later CVO models or '11 FLHTCUSE.

* NOTE: The H-D® Advanced Audio Radio or H-D Boom! Audio Amplifier will power up to a total of 4 speakers. A 3rd and 4th pair of speakers require the use of Speaker Expansion Kit P/N 76000263. Additional speaker options include Boom! Audio Fairing Lower Speakers, Boom! Audio Saddlebag Lid Speakers or Boom! Audio Tour-Pak® Rear Speakers.

Model Family Fitment:

- V-ROD
- SPORTSTER
- DYNA
- SOFTAIL
- TOURING

Notice: The prices appearing in this catalog are the manufacturer's suggested retail prices. Actual retail prices may vary.

682 AUDIO & GAUGES

Boom!™ Audio – '06-'13 Touring

A. BIKE-TO-BIKE (B2B) COMMUNICATIONS KIT

Communicate with your friends on any of 40 channels. Easy-to-use handlebar controls allow PTT and adjustable squelch levels for maximum performance and reception quality. Integrated CB System will mute the radio while in transmit or receive mode. Bike-to-bike system allows you and your passenger to talk with other riders, even when you are miles apart.

76000390 **\$349.95**

Fits '06-'13 Touring models equipped with an Advanced Audio Radio (except FLTRX, FLTRXSE and '11-'12 FLHXSE). Requires separate purchase of additional components (see your Dealer or instruction sheet for model-specific requirements).



A. BIKE-TO-BIKE (B2B) COMMUNICATIONS KIT

B. COMMUNICATIONS SWITCH KIT

Allows the use of a Harley-Davidson® helmet headset on Touring models that are not equipped with the helmet headset interface. This kit contains Console Pod Assembly, Left-Hand Control Switch Assembly and Fairing Speaker Switch.

77173-08 **\$259.95**

Fits '08-'13 Touring (except FLTRX, FLTRXSE and '11-'12 FLHXSE) and '10-'11 FLHXXX models equipped with an Advanced Audio Radio System. Installation requires separate purchase of appropriate Wiring Harness. FLHX models require separate purchase of additional installation components (see instruction sheet).



B. COMMUNICATIONS SWITCH KIT

C. BOOM!™ AUDIO SYSTEM WIRING HARNESSES

Allows installation of multiple Boom!™ Audio accessory combinations and allows any or all of the following: SiriusXM®, Bike-to-Bike and other communications kits, headsets, additional speakers, amplifiers, iPod® Interface and Navigation Interface.

70169-06A **\$114.95**

Fits '06-'13 FLHT, FLHTC, FLHX, FLTR, FLTRX, '10 FLHXSE '09 FLTRSE and '10-'11 FLHXXX models equipped with Advanced Audio Radio. Does not fit '11-'13 CVO™ models.

Allows installation of SiriusXM Satellite Radio Kit on Ultra models. Does not provide connections for additional components.

70172-06 **\$49.95**

Fits '06-'13 FLHTCU, FLHTK and FLTRU and '09-'13 FLHTCUTG models equipped with Advanced Audio Radio.

Allows installation of Boom! Audio Fairing Amplifier with additional speakers. Also allows installation of iPod Interface and/or Navigation Interface Module on select models. See dealer for details.

69200106 **\$39.95**

Fits '06-'13 Touring and '10-'11 FLHXXX models.

Allows installation of iPod Interface and/or Navigation Interface Module on models not previously equipped with other Boom! Audio accessories. If additional Boom! Audio accessories will be installed, see dealer for details.

69200033 **\$19.95**

Fits '06-'13 Touring and '10-'11 FLHXXX models.



70169-06A

C. BOOM! AUDIO SYSTEM WIRING HARNESSES



70172-06

69200106

69200033

C. BOOM! AUDIO SYSTEM WIRING HARNESSES

Model Family Fitment:

- V-ROD
- SPORTSTER
- DYNA
- SOFTAIL
- TOURING

Notice: The prices appearing in this catalog are the manufacturer's suggested retail prices. Actual retail prices may vary.

WIRELESS COMMUNICATION

Riding alone is a good way to unwind and clear your head. But if you've got a passenger, or you're riding with a group, inevitably you'll need to communicate with others. A tap on the helmet, a hand signal or frantic waves only get you so far. Welcome to Boom!™ Audio wireless Bluetooth® technology.

Boom! Audio Bluetooth headsets allow riders and passengers to connect on the open road. These comfortable headsets permit a number of riders to pair into the network and "rebroadcast" signals up and down the line to extend the effective range. In addition to driver-to-rider intercom and bike-to-bike communication, these wireless headsets let you connect to cell phones, GPS devices, and personal music players.

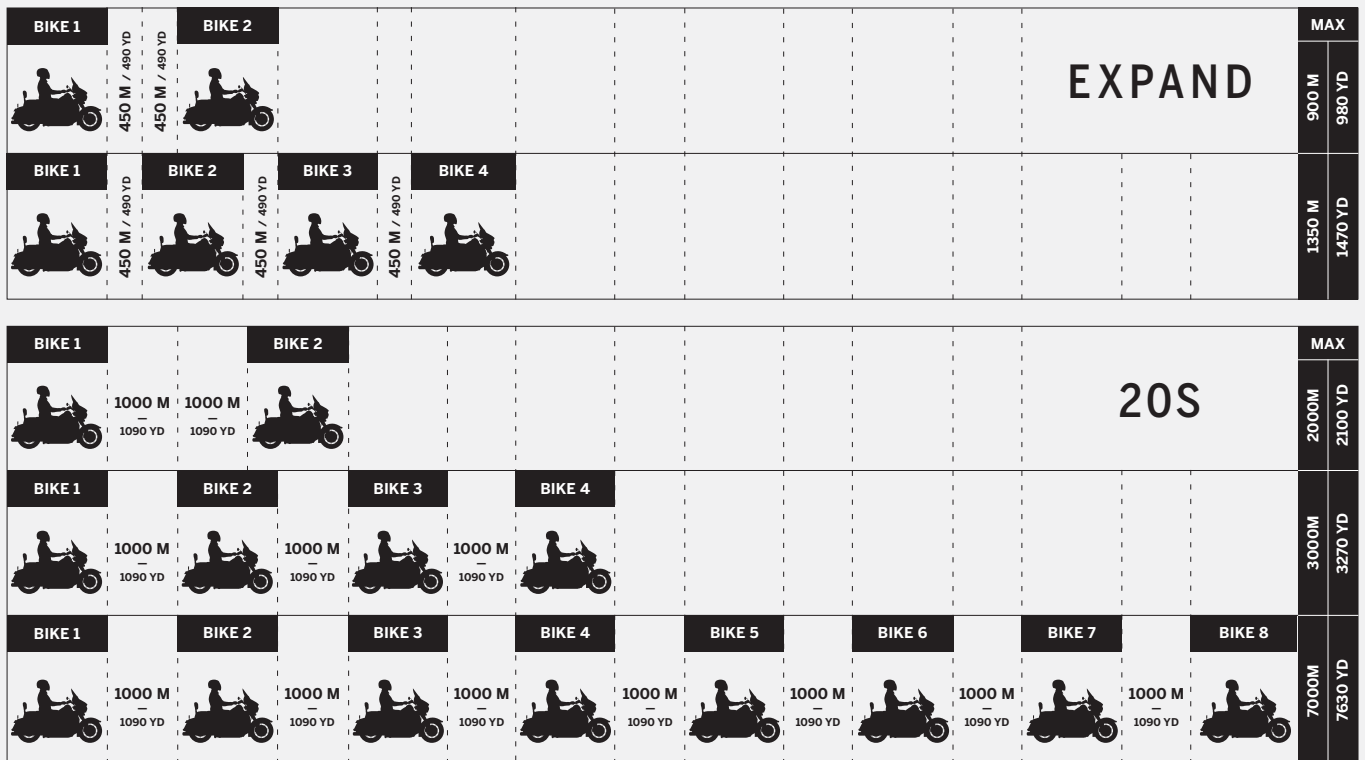

The total distance increases as the number of riders increase, but the distance between each rider decreases as you add additional riders to the communication chain. Rider-to-rider connectivity may vary depending on terrain and traffic.

BOOM!™ AUDIO EXPAND HALF HELMET COMMUNICATION SYSTEM

- Bluetooth® 3.0
- Intercom up to 900 Meters
- Four-Way Intercom
- Audio Boost
- Bluetooth Stereo Music
- Music Sharing
- Advanced Noise Control™



BOOM! AUDIO 20S FULL HELMET COMMUNICATION SYSTEM

- Bluetooth® 4.1
- Audio Multitasking
- Intercom up to 2.0 km
- Eight-Way Intercom
- Voice Command
- Playback Control
- Advanced Noise Control™
- FM Radio Tuner



684 AUDIO & GAUGES

Headsets

A. WIRELESS HEADSET INTERFACE MODULE

It's time to cut the cord with your bike. Now available for '14-later Touring and Trike models equipped with Boom!™ Audio 6.5GT Radios, this Wireless Headset Interface Module (WHIM) lets you communicate with your bike without being wired to it. The WHIM Bluetooth adapter permits wireless connectivity to the 6.5GT infotainment system, allowing you to communicate via CB radio, hear turn-by-turn GPS directions, listen to your favorite radio stations and so much more all through your Bluetooth®-enabled headset.

Bluetooth Wireless Technology

Wireless interface permits full access to the Infotainment features without the hassle of being connected to the bike. You have full freedom of movement for turning your head and getting off the bike at fuel stops.

Integrated Into the 6.5GT Radio

Seamlessly use all wired headset functionality (CB, Phone, Intercom, Navigation, Radio) without the compromises of aftermarket systems, and configure your Boom! Audio 20S headset directly from the radio controls.

Superior Audio Quality

Harley-Davidson® headsets feature proprietary software that delivers superior audio quality with stereo output compared to non-Harley® headsets which provide a mono sound output.

Dual Headset Connectivity

Two Bluetooth-enabled headsets can be connected to one WHIM, simplifying installation and keeping costs in line.

Integrated Behind the Fairing

Module mounts behind the fairing and connects directly to the radio, eliminating external wires and connections to console and Tour-Pak communication ports.

Compatible with H-D® Wireless Headsets

Current H-D® wireless headsets are completely compatible. No need to purchase new headsets to use the WHIM system. Harley headset volume can be adjusted from the motorcycle hand controls.

Impact of Retrofit on Wired Microphone Functionality

Upon installation of the WHIM, your motorcycle's wired microphone functionality will no longer be available. However, wired audio will continue to function as before.

76000768

\$299.95

Fits '14-later Touring and Trike models equipped with a Boom! Box 6.5GT or Boom! Box GTS audio system. '14-'17 models require the separate purchase of Wireless Headset Interface Module Harness P/N 69201726. Installation on '14-'15 FLHTKSE models will result in reduced satellite radio reception. Dealer Digital Technician™ software update is required. Dealer installation is recommended.

Also available:

WIRELESS HEADSET INTERFACE MODULE HARNESS

Required for installation of Wireless Headset Interface Module on '14-'17 Touring and Trike models.

69201726

\$49.95

Fits '14-'17 Touring and Trike models equipped with a Boom! Box 6.5GT audio system and Wireless Headset Interface Module P/N 76000768.



A. WIRELESS HEADSET INTERFACE MODULE



A. WIRELESS HEADSET INTERFACE MODULE

Model Family Fitment:

- V-ROD
- SPORTSTER
- DYNA
- SOFTAIL
- TOURING

Notice: The prices appearing in this catalog are the manufacturer's suggested retail prices. Actual retail prices may vary.

AUDIO & GAUGES 685

Headsets

B. BOOM!™ AUDIO 20S EVO BLUETOOTH® HELMET HEADSET

The Boom!™ Audio 20S EVO headset is a state-of-the-art Bluetooth 4.1 communication system. With the 20S EVO, users can call handsfree with their Bluetooth® mobile phones, listen to stereo music or voice instructions of GPS navigation by Bluetooth wirelessly, and have intercom conversations in full duplex with a passenger and/or other riders.

The weather resistant Boom! Audio 20S EVO Full Helmet Headset permits you to enjoy your group ride by keeping you in touch with up to eight other riders in crystal-clear HD™ audio – up to 2.0 km (1.2 miles) away – through the Group Intercom™ feature. The 20S EVO uses the Universal Intercom™ protocol so it can be paired with many other available Bluetooth headsets. The 20S EVO headset features Audio Multitasking™ technology that enables intercom conversation while simultaneously listening to the built-in FM radio or Bluetooth-sourced music or GPS instructions. Audio Multitasking allows a seamless integration of incoming and outgoing audio, and eliminates the interruption-based audio functions of many Bluetooth communication devices.

The unit provides a sleek and aerodynamic design that offers a versatile jog dial that maximizes the ease of use for riders. The user interface makes setting up and pairing your 20S EVO incredibly easy. And once you're on the road, complete control of the 20S EVO can be done through hands-free voice commands. Intuitive technology ensures safe, controlled riding as you seamlessly move through music, phone, and intercom features. Linking up your 20S EVO via the available smartphone app (for Android® or iPhone®) allows you to configure device settings, set groups of intercom friends, and access a Quick Guide. The 20S EVO also offers the ability to pair with up to two mobile phones for convenient hands-free calling.

20S EVO talk time is 13 hours, and the device can remain charged for up to 10 days in standby mode. Kit includes the 20S EVO headset unit, universal helmet clamp, two in-helmet stereo speakers, static and wired boom microphones, micro USB power and data cables, and all mounting hardware.

Fits most Harley-Davidson® full and 3/4 helmets. Bluetooth headset is compatible with Harley-Davidson Original Equipment 6.5GT Boom! Box and Boom! Box GTS radio when equipped with Wireless Headset Interface Module P/N 76000768.

76000736A	Single Headset.	\$299.95
76000740A	Dual Headset Pack.	\$549.95

NOTE: Headset software update may be required for use with Wireless Headset Interface Module P/N 76000768. Visit H-D.com for details.



B. BOOM! AUDIO 20S EVO BLUETOOTH HELMET HEADSET



B. BOOM! AUDIO 20S EVO BLUETOOTH HELMET HEADSET

Notice: The prices appearing in this catalog are the manufacturer's suggested retail prices. Actual retail prices may vary.

686 AUDIO & GAUGES

Headsets

A. BOOM!™ AUDIO EXPAND BLUETOOTH® HALF HELMET HEADSET

The Boom!™ Audio Expand Half-Helmet Headset features a long-range Bluetooth® 3.0 Intercom designed specifically for riding and other outdoor sports activities. The one-piece headset allows you to call hands-free on your Bluetooth mobile phone, listen to stereo music or GPS navigation instructions, and have intercom conversations in full duplex with your passenger and/or fellow riders. Bluetooth 3.0 and advanced digital processing technology permits connectivity with other devices up to 900 meters (980 yards) away, while delivering best-in-class incoming and outgoing sound quality. The headset can be easily paired with up to two phones, and because it operates on the Universal Intercom protocol, the headset can be connected with your fellow rider's gear – regardless of the manufacturer. The Bluetooth 3.0 stereo headset brings your favorite tunes, GPS navigation, four-way intercom conversations, and hands-free calling to any type of motorcycle. The simple to operate glove-friendly jog dial and large buttons on the headset control the major functions, and the comfortable ear hooks and behind-the-neck strap keep the headset firmly in place while riding. Boom! Audio Expand Bluetooth headsets feature automatic volume boost and Advanced Noise Control technology to produce crystal clear audio in noisy environments. The headset is fully water resistant, and the long-life battery permits up to 10 hours of talk time and seven days of standby on a single charge. Kit includes the stereo headset, mini and boom microphones, micro USB power and data cable, and stereo audio cables. Want the best in hands-free tech for your bike? The Boom! Audio Expand Half-Helmet Headset, coupled the Boom! Box GTS Radio or with the Harley-Davidson Wireless Interface Module (WHIM) (both sold separately) provides the best hands-free experience. When coupled with the WHIM, it replaces the wired headset connection to the bike.

76000835 **\$159.95**
Fits most Harley-Davidson® half helmets. Bluetooth headset is compatible with Harley-Davidson Original Equipment Boom! Audio GTS and Boom! Audio 6.5GT radios when equipped with Wireless Headset Interface Module P/N 76000768.

B. BOOM! AUDIO HALF HELMET MUSIC AND COMMUNICATIONS HEADSET

Great-sounding foam-covered on-ear stereo headphone cups reduce wind noise while allowing you to hear surrounding traffic. This comfortable headset is designed to allow full music and communication function while wearing a half helmet. Lightweight, durable neck bow wraps around the ear and across the back of the neck and fits comfortably below the shell of most half helmets. The adjustable boom microphone with wind sock has been optimized for superior clarity when connected to Harley-Davidson® intercom and Bike-to-Bike communications equipment and the quick-disconnect plug allows you to step away from the motorcycle without removing the headset. A clothing clip (not shown) is included for added comfort and reduced ear fatigue. The coiled cord permits freedom of movement in the saddle. The 7-pin DIN plug can be connected to the front and rear communications ports, allowing both rider and passenger access to the music, navigation and voice communications features of the motorcycle.

76572-09 7-pin DIN Connector. **\$119.95**
Fits '98-later FLHTCU, FLHTCUSE, FLHTK, FLHTKSE, FLTRU, FLTRUSE and FLHTCUTG models. Also fits with vehicles equipped with Communication Switch Kit P/N 77173-08 or Boom! Audio Music and Intercom Kits.

NEW



A. BOOM! AUDIO EXPAND BLUETOOTH HALF HELMET HEADSET



B. BOOM! AUDIO HALF HELMET MUSIC AND COMMUNICATIONS HEADSET



NEW



HARLEY-DAVIDSON
BOOM! AUDIO N01
HALF HELMET

Model Family Fitment:

- V-ROD
- SPORTSTER
- DYNA
- SOFTAIL
- TOURING

Notice: The prices appearing in this catalog are the manufacturer's suggested retail prices. Actual retail prices may vary.

MORE WAYS TO STAY CONNECTED

Check out the new Harley-Davidson Boom!™ Audio N01 Half Helmet with a built-in Sena 10R Bluetooth® communication system for integrated hands-free communications and Boom!™ Audio compatibility.

98316-18VX



C. BOOM! AUDIO PREMIUM HALF HELMET MUSIC & COMMUNICATIONS HEADSET



C. BOOM!™ AUDIO PREMIUM HALF HELMET MUSIC & COMMUNICATIONS HEADSET

This comfortable headset is designed to allow full music and communication function while wearing a half helmet. High-strength pivoting neck band with rubber protector wraps across the back of the neck and fits comfortably below the shell of most half helmets. Over-the-ear hooks keep speakers comfortably in place. This headset features premium voice coils and vented housings for enhanced bass, mid-and-high frequency response. The great-sounding foam-covered on-ear stereo headphone cups reduce wind noise while allowing you to hear surrounding traffic. The adjustable boom microphone with wind sock has been optimized for use with Harley-Davidson® intercom and Bike-to-Bike communications equipment and the streamlined cord with push button clothing clip and quick-disconnect plug allows you to step away from the motorcycle without removing the headset. The 7-pin DIN plug can be connected to the front and rear communications ports, allowing both rider and passenger access to the music, navigation and voice communications features of the motorcycle. The headset includes a custom zippered storage case for added protection.

76000730 7-pin DIN Connector. **\$149.95**
 Fits '98-later FLHTC, FLHTCU, FLHTCUL, FLHTCUSE, FLHTCUTG, FLHTK, FLHTKL, FLHTKSE, FLTRU and FLTRUSE (except models set up for wireless headsets), models. Also fits with vehicles equipped with Communication Switch Kit P/N 77173-08, Music and Communications Kit P/N 69200856, or Boom!™ Audio Music and Intercom Kits.



D. BOOM! AUDIO FULL HELMET PREMIUM MUSIC AND COMMUNICATIONS HEADSET



D. BOOM! AUDIO FULL HELMET PREMIUM MUSIC AND COMMUNICATIONS HEADSET

This comfortable headset is designed to allow full communication function while wearing a .75 or full-face helmet. The stylish plug module clamps to the base of the helmet and positions the adjustable wind sock-equipped boom microphone for the best sound quality. Great-sounding foam-covered stereo earphones comfortably fit into ear pockets in the helmet and the fine wires are easy to hide beneath the helmet liner for a clean installation. The quick-disconnect plug allows you to step away from the motorcycle without removing the helmet and the coiled cord permits freedom of movement in the saddle. The 7-pin DIN plug can be connected to the front and rear communications ports, allowing both rider and passenger access to the music, navigation and voice communications features of your motorcycle and the microphone has been optimized for superior clarity when connected to Harley-Davidson intercom and Bike-to-Bike communications equipment.

77117-10 **\$189.95**
 Fits '98-later FLHTCU, FLHTCUSE, FLHTK, FLHTKSE, FLTRU, FLTRUSE and FLHTCUTG models (except models set up for wireless headsets). Also fits with vehicles equipped with Communication Switch Kit P/N 77173-08 or Boom! Audio Music and Intercom Kits.



E. EXTENDED LENGTH COMMUNICATIONS HEADSET CORD



F. HAND-HELD CB MICROPHONE KIT

E. EXTENDED LENGTH COMMUNICATIONS HEADSET CORD

Extended Headset Cord is an essential option for a tall rider or passenger. When compared to the stock headset cord, this cord provides five additional inches of length at rest and up to 22 additional inches of length when fully stretched. The additional length and relaxed twist of the cord reduces the spring effect and the included clothing clip eliminates the tension that can lead to neck fatigue. The 7-pin DIN plug can be connected to the front and rear communications ports, giving both rider and passenger access to the music, navigation and voice communications features of your motorcycle. This cord is a direct plug-in replacement for the standard length headset cord on the Original Equipment headset or the Boom! Audio Full Face Helmet Communications Headset P/N 77117-10.

76000259 **\$44.95**
 Fits '10-later Original Equipment Ultra-style Headsets P/N 77147-98A (Domestic) or 77156-98A (HDI), Boom! Audio Full Face Helmet Communications Headset P/N 77117-10 and Half Helmet Headsets P/N 76000145 and 76572-09.

F. HAND-HELD CB MICROPHONE KIT

Comes complete with handlebar mounting bracket and all necessary hardware.

76312-98 **\$99.95**
 Fits '98-'13 FLHTC, FLHTCU and FLTRU and '09-'13 FLHTCUTG models. Also fits models equipped with Communication Kits 77107-09, 77108-09A and 77173-08.

Notice: The prices appearing in this catalog are the manufacturer's suggested retail prices. Actual retail prices may vary.

688 AUDIO & GAUGES

Antennas

A. HIDDEN AM/FM/WB ANTENNA

Hide the AM/FM/WB antenna inside the fairing for a clean, uncluttered look. Uniquely tuned to the Harley-Davidson® radio, this enhanced Hidden Antenna offers reception performance equivalent to the Original Equipment whip antenna and superior to the Shorty Antenna. Perfect for your clean slick custom bagger, this Hidden Antenna is also the ideal addition to models equipped with H-D® Detachables™ Tour-Pak® luggage because it eliminates the need to move the whip antenna back and forth between Tour-Pak luggage and fender mounting locations. Kit includes all required mounting hardware and wiring.

NOTE: Relative antenna performance as compared to stock Original Equipment antenna; results based on reception evaluation conducted in Milwaukee area. Actual performance will be influenced by signal strength and electrical interference in your area. Follow the installation and routing instructions carefully to obtain the best possible performance from the antenna.

76000862 **\$69.95**

Fits '14-later Touring and Trike models with Original Equipment AM/FM/WB Boom!™ Box Audio System. Separate purchase of Power Extension Harness P/N 69200921 is required if installed with Boom! Bagger Kits P/N 76000410 or P/N 76000411, Boom! Audio Amplifier Kit P/N 76000278 and 76000523. Electric Glo™ Headlamp Trim Rings or Fairing Edge Lights.

76000863 **\$69.95**

Fits '98-'13 Touring and Trike models equipped with AM/FM/WB radio and fairing.



**A. HIDDEN AM/FM/WB ANTENNA
(76000862 SHOWN)**



**A. HIDDEN AM/FM/WB ANTENNA
(76000863 SHOWN)**

B. SHORTY ANTENNAS

This compact antenna is only 19.0" tall and is a stylish change from the Original Equipment whip antenna. The low-profile antenna simplifies covering the bike for storage. Easy to install, the Shorty Antenna screws on to the factory antenna mount.

76386-09A CB Radio. **\$29.95**

Fits '09-later Touring and Trike models equipped with Bike-to-Bike Communication. May require model-specific mounting bracket if installed on a model without a Tour-Pak carrier.

76386-08 CB Radio. **\$29.95**

Fits '98-'08 Touring models equipped with Bike-to-Bike Communication. May require model-specific mounting bracket if installed on a model without a Tour-Pak carrier.

76388-08A AM/FM. **\$29.95**

Fits '98-later Touring and Trike models equipped with radio.



**B. SHORTY CB ANTENNA
(SHOWN WITH SHORTY AM/FM ANTENNA)**



B. SHORTY ANTENNA – AM/FM

C. AM/FM ANTENNA KIT – TOUR-PAK® MOUNT

The AM/FM Antenna Kit mounts an antenna on a Tour-Pak luggage system. Kit includes Original Equipment style Fiberglass AM/FM Antenna P/N 76503-08, all necessary mounting brackets, cable hardware and instructions. Fits all Tour-Pak luggage systems.

76251-98A **\$49.95**

Fits '98-'13 Touring and Trike models with Tour-Pak luggage.

D. CB ANTENNA KIT – TOUR-PAK MOUNT

The CB Antenna Kit mounts an antenna on a Tour-Pak luggage system. Kit includes Original Equipment style CB antenna, all necessary mounting brackets, cable hardware and instructions. Fits all Tour-Pak luggage systems.

76400-09 **\$89.95**

Fits '09-'13 Touring models with Tour-Pak luggage. Includes Fiberglass CB Antenna P/N 76250-09.

E. CB ANTENNA KIT – FRAME MOUNT

Will enable the installation of a CB antenna on the right side of a fender. Kit includes CB antenna and mounting brackets.

76410-09 **\$99.95**

Fits '09-'13 FLHX, FLTR and FLTRX models. Does not fit CVO™ models. Includes Fiberglass CB Antenna P/N 76250-09.

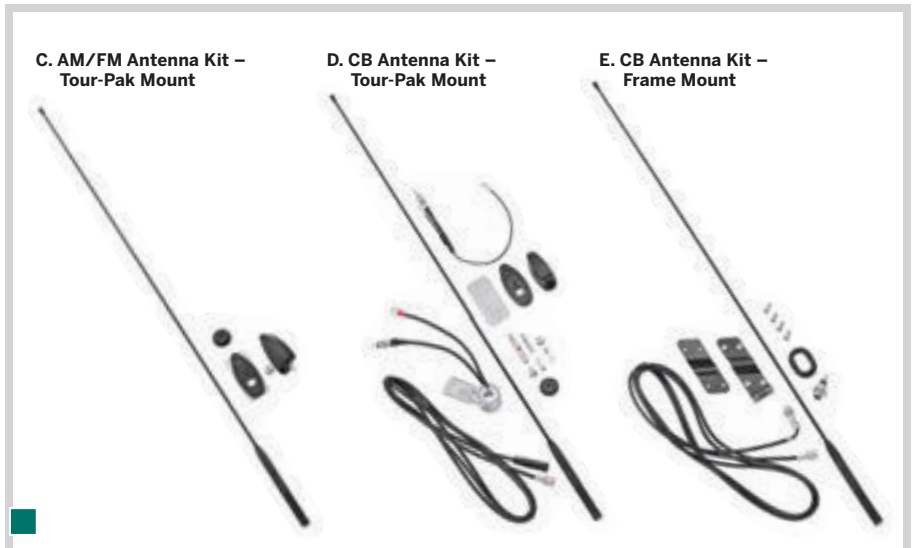

ANTENNA KITS

Notice: The prices appearing in this catalog are the manufacturer's suggested retail prices. Actual retail prices may vary.

AUDIO & GAUGES 689

Antennas



F. CB ANTENNA RELOCATION KIT



G. AM/FM ANTENNA RELOCATION KIT



H. ANTENNA RELOCATION KIT FOR FLTR/FLHX WITH H-D DETACHABLES TWO-UP LUGGAGE RACK



I. ANTENNA RELOCATION KIT, AM/FM '09-'13 MODELS

F. CB ANTENNA RELOCATION KIT

Relocates your CB antenna to the rear fender to accommodate use with a H-D® Detachables™ Two-Up Tour-Pak® Luggage Mounting Rack. Kit includes mounting bracket, all mounting hardware and wiring harness.

76000308 **\$74.95**

Fits '14-later FLHTCU, FLHTCUL, FLHTK, FLHTKL, FLHTKSE, FLTRU and FLTRUSE models equipped with H-D Detachables Tour-Pak Conversion Kit P/N 53000291A.

G. AM/FM ANTENNA RELOCATION KIT

Relocates your AM/FM antenna to the rear fender to accommodate use with an H-D Detachables Two-Up Tour-Pak Mounting Rack. Kit includes mounting bracket, all mounting hardware and wiring harness.

76000582 **\$74.95**

Fits '14-later FLHX, FLHXS, FLTRX and FLTRXS models.

H. ANTENNA RELOCATION KIT FOR FLTR/FLHX WITH H-D® DETACHABLES™ TWO-UP LUGGAGE RACK

Relocate your AM/FM antenna for use with H-D Detachables Two-Up Luggage Rack.

76561-09 **\$29.95**

Fits '09-'13 FLHX, FLTR, FLTRU and FLTRX models (except FLTRUSE, FLTRXSE, '10-'12 FLHXSE and '09 FLTRSE models) equipped with Detachable Two-Up Luggage Rack P/N 54215-09. Does not fit with Nostalgic Saddlebag Guard Rail Kit P/N 91286-10.

76208-07 **\$34.95**

Fits '97-'08 FLHX and FLTR equipped with Detachable Two-Up Luggage Rack P/N 53743-97 and Two-Up Detachable Docking Hardware Kit P/N 53804-06.

I. ANTENNA RELOCATION KIT – AM/FM

This Antenna Relocation Kit allows you to easily switch between your detachable Tour-Pak luggage, a detachable passenger backrest or the clean look of a stock FLHT or FLTR.

76556-09 **\$79.95**

Fits '09-'13 FLHT, FLHTC, FLHX, FLTR and FLTRX models. Does not fit CVO™ models.

Model Family Fitment:

- V-ROD
- SPORTSTER
- DYNA
- SOFTAIL
- TOURING

Notice: The prices appearing in this catalog are the manufacturer's suggested retail prices. Actual retail prices may vary.

690 AUDIO & GAUGES

Mobile Phone Mounts

A. HANDLEBAR PHONE CARRIER MOUNT

Designed to place a smartphone or music device close at hand, this ball-tipped mount is secured to the left-side or right-side hand control perch for easy access. When combined with the Universal Phone Carrier P/N 76000549 or Water Resistant Carriers P/N 76000576, 76000605, or 76000670, the ball-shaped mount provides a wide range of adjustability for the ideal viewing angle.

76000537 **\$29.95**

Fits '02-'17 VRSC™ (except VRSCF and VRSCR), '04-later XL (except XL883N, XL1200N and XL1200NS), '08-'13 XR, '06-'17 Dyna® (except FXDB), '00-later Softail®, '09-later Touring (except FLHTKSE and '15-later FLTRU, FLTRX, FLTRXS and FLTRXSE), and '09-later Trike models.

76000758 **\$29.95**

Fits '15-later XG models. Requires the separate purchase of an H-D Smart Phone Carrier.



A. HANDLEBAR PHONE CARRIER MOUNT

B. UNIVERSAL HANDLEBAR MOUNT PHONE CARRIER

Put your smartphone within easy reach. This standard cradle places your phone or music device close to the hand controls of the motorcycle for easy access. Dual thumb screw clamps quickly adjust to grip the phone, and non-slip pads hold the device in place – in vertical or horizontal orientation. When combined with the control lever perch Phone Carrier Mount (sold separately), the swivel head allows the phone to be rotated into the ideal viewing position, and the device can be removed in seconds when you reach your destination. Holds devices measuring 1.75" to 3.5" wide.

76000549 **\$39.95**

Fits '02-'17 VRSC (except VRSCF and VRSCR), '04-later XL (except XL883N, XL1200N and XL1200XS), '08-'13 XR, '06-'17 Dyna (except FXDB), '00-later Softail, '09-later Touring (except FLHTKSE and '15-later FLTRU, FLTRX, FLTRXS and FLTRXSE), and '09-later Trike models. Requires separate purchase of Phone Carrier Mount P/N 76000537.

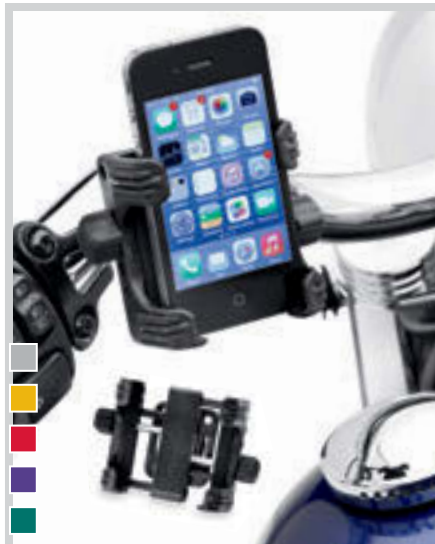

B. UNIVERSAL HANDLEBAR MOUNT PHONE CARRIER



C. WATER RESISTANT HANDLEBAR MOUNT PHONE CARRIER – SAMSUNG GALAXY S3/4

C. WATER RESISTANT HANDLEBAR MOUNT PHONE CARRIER

Designed for life on the road, this rigid rain and dust resistant case protects your phone from the elements during all kinds of riding conditions. Ideal for use with a Bluetooth®-paired phone and infotainment system or headset, the hard case features a 360° gasket design that seals your phone inside with a positive full length hinge and clamp. The screen protecting membrane permits fingertip operation of all on-screen functions, and the case's crystal clear back allows unencumbered camera use. When combined with the Phone Carrier Mount (sold separately), the swivel head allows the phone to be rotated into the ideal viewing position, and the device can be removed in seconds when you reach your destination.

Fits '02-'17 VRSC (except VRSCF and VRSCR), '04-later XL (except XL883N, XL1200N and XL1200NS), '08-'13 XR, '06-'17 Dyna (except FXDB), '00-later Softail, '09-later Touring (except FLHTKSE and '15-later FLTRU, FLTRX, FLTRXS and FLTRXSE), and '09-later Trike models. Requires separate purchase of Phone Carrier Mount P/N 76000537.

76000605 For Samsung Galaxy S3/4 Phones. **\$69.95**

76000576 For Apple iPhone 5/5S Phones. **\$69.95**

76000670 For Apple iPhone 6/6S Phone. **\$74.95**

NOTE: Apple, iPhone, Samsung, and Galaxy S are trademarks of their respective owners.

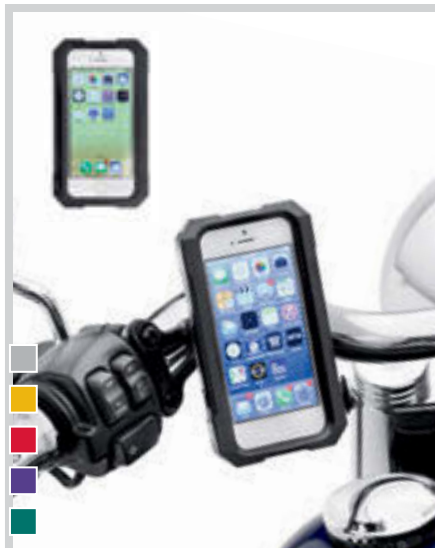

C. WATER RESISTANT HANDLEBAR MOUNT PHONE CARRIER – APPLE IPHONE 5/5S

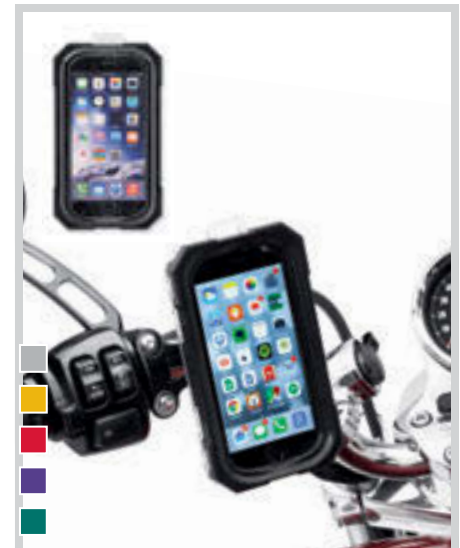

C. WATER RESISTANT HANDLEBAR MOUNT PHONE CARRIER – APPLE IPHONE 6/6S

Model Family Fitment:

- V-ROD
- SPORTSTER
- DYNA
- SOFTAIL
- TOURING

Notice: The prices appearing in this catalog are the manufacturer's suggested retail prices. Actual retail prices may vary.

AUDIO & GAUGES 691

Amp & Speaker Kit



D. BOOM! AUDIO BLUETOOTH CRUISER AMP & SPEAKER KIT – CHROME



D. BOOM! AUDIO BLUETOOTH CRUISER AMP & SPEAKER KIT – SATIN BLACK



E. BOOM! AUDIO BLUETOOTH CRUISER AMP & SPEAKER EXPANSION KIT – CHROME



E. BOOM! AUDIO BLUETOOTH CRUISER AMP & SPEAKER EXPANSION KIT – SATIN BLACK

D. BOOM!™ AUDIO BLUETOOTH® CRUISER AMP & SPEAKER KIT

Boom!™ Audio Cruiser Amp and Speaker Kits provide amplified music through two great-sounding handlebar-mounted speakers. The bullet shaped enclosures house a 3.6" woofer and separate 1" tweeter that combine to deliver rich bass notes and sparkling highs. The waterproof speaker elements are protected behind stylish metal grills that are finished with a center-mounted trim ring. Powered by a self-contained 40 watt RMS amplifier, these speakers can cut through the background noise and deliver clear, crisp sound. Cruiser Speakers feature wireless Bluetooth® technology for easy connectivity with a smart phone, GPS unit or other music player, and can also connect to traditional music players through a standard 3.5mm stereo auxiliary input.

Available in chrome or black finish, the individual speaker pods clamp to either a 1.0" or 1.25" handlebar and can be adjusted to direct the sound toward the rider. Thumb-activated switches that control on/off/pause, track forward/back, and volume level are conveniently mounted above the right switch housing for easy reach while your hands remain on the grips. Complete kit includes all wiring and mounting hardware. For a complete 4-speaker surround-sound experience, add the optional rear sissy bar mounted Speaker Expansion Kit.

Fits '04-later XL (except XL1200CB, XL1200CX, XL1200L, XL1200N, XL1200T, XL1200V, XL1200X, XL1200XS, XL1200NS '13-later XL883N), '06-'17 Dyna® and '00-later Softail® models (except FLS, FLSS, FLXL, FLSS, FXBB, FXDRS, FXFB, FXFBS and FXS). Also fits '09-later Road King®, and '15-later FLRT models. '14-later XL, '12-'17 Dyna and '11-'17 Softail models require separate purchase of Electrical Connection Kit P/N 72673-11. '14-'16 FLHR, FLHRC, FLHRXS and FLRT models require Electrical Connection Kit P/N 69200722. '18-later Softail and FLHR, FLHRC and FLRT models require Electrical Connection Kit P/N 69201599A. Not for use with Chizeled handlebars, SiriusXM® Handlebar Mount P/N 76390-05A, Sport Windshields, 1/4 Fairing or windshield bags.

76000635	Chrome.	\$529.95
76000636	Satin Black.	\$529.95

E. BOOM! AUDIO BLUETOOTH CRUISER AMP & SPEAKER EXPANSION KIT

Add a complete 4-speaker surround-sound experience to your Harley-Davidson® cruiser motorcycle. When combined with the front mounted Boom! Audio handlebar speaker package, these rear sissy bar-mounted speakers dramatically enhance the sound quality of your music system. The waterproof two-way speakers feature 3.6" woofers and separate 1" tweeters for a rich full range sound, and the integrated 40 watt RMS amplifier helps the music cut through the road and wind noise.

This Expansion Kit connects to the front-mounted speaker system, and is operated by the handlebar speaker's controls and Bluetooth connectivity. Available in chrome or satin black finish, these custom speaker enclosures feature a unique mounting system with adjustable clamps that can be mounted to most round and square bar sissy bar uprights. The speakers can be positioned to direct the sound toward the rider and passenger seating area. Complete kit includes speakers, wiring harness, and hardware.

Fits '04-later XL (except XL1200CB, XL1200CX, XL1200L, XL1200T, XL1200V, XL1200X, XL1200XS, XL1200NS and '13-later XL883N), '06-'17 Dyna and '00-later Softail models (except FLS, FLSS, FLXL, FLSS, FXDRS, FXFB, FXFBS and FXS). Also fits '09-later Road King models with an Original Equipment or accessory sissy bar upright. The installation of Boom! Audio Bluetooth Amp & Speaker Kit P/N 76000635 or 76000636 is required. '14-later XL, '12-'17 Dyna and '11-'17 Softail models require separate purchase of Electrical Connection Kit P/N 72673-11. '14-'16 FLHR, FLHRC and FLHRXS models require Electrical Connection Kit P/N 69200722. '18-later Softail and '17-later FLHR and FLHRC models require Electrical Connection Kit P/N 69201599A and Hardware P/N 72114-94BK, 72191-94 and 72154-94.

76000666	Chrome.	\$249.95
76000700	Satin Black.	\$249.95

Notice: The prices appearing in this catalog are the manufacturer's suggested retail prices. Actual retail prices may vary.

692 AUDIO & GAUGES

Navigation

A. ROAD TECH™ ZŪMO® 590 NAVIGATION SYSTEM

The road ahead is easy to see on a 5" dual-orientation touch-screen display that is glove friendly and sunlight readable – you'll find it on the rough and rugged Road Tech™ zūmo® 590LM premium GPS motorcycle navigator. Tough enough to withstand the brutal elements and the harsh weather conditions, the zūmo 590LM offers hands-free phone control and spoken directions heard in-helmet via Bluetooth® technology. zūmo includes an MP3 player and works with iPod® and Pandora® for music control right on its display.

- Bright sunlight readable high resolution display
- Smartphone Link – Enables the customer to access basic weather, local search
- Active Lane Guidance, exit services and PhotoReal junction views
- Curvy Road/Round Trip Feature
- Media Player – Integrated iPod control with MP3 player
- Pandora Music Player
- Upgradable features include advanced weather radar/alerts, live traffic images, fuel prices, safety cameras

Fits '02-'17 VRSC™ (except VRSCF and VRSCR), '04-later XL and XR (except XL883N, XL1200N and XL1200NS), '06-'17 Dyna® (except FXDB), '00-later Softail® (except FXFB and FXFBS), '09-later Road King® and Road Glide®, '14-later Electra Glide®, Ultra Limited and Street Glide® (except '14-'16 CVO™ models), and Trike models with the separate purchase of Handlebar Mount Kit P/N 76000191A or 76000192A. Also fits '09-'13 Touring models (except Road King and Road Glide) and Trike models with separate purchase of Fairing Mount Kit P/N 92238-09. '14-later XL, '12-'17 Dyna and '11-'17 Softail models require separate purchase of Electrical Connection Kit P/N 72673-11. '14-'16 Touring and Trike models require separate purchase of Electrical Harness Extension P/N 69200722. '18-later Softail and '17-later models require Electrical Harness Extension P/N 69201599A.

76000573	North America.	\$799.95
76000574	International.*	\$699.95

*Maps not included.

Notice: The prices appearing in this catalog are the manufacturer's suggested retail prices. Actual retail prices may vary.



A. ROAD TECH ZŪMO 590 NAVIGATION SYSTEM

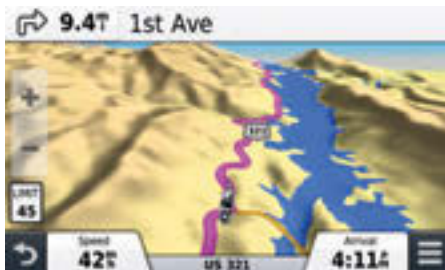

Curvy Road / Round Trip Feature



Active Lane Guidance, exit services and PhotoReal junction views



Media Player – Integrated iPod control, MP3 player and Pandora Music Player

In The Box

- zūmo 590LM
- Preloaded City Navigator® NT (North America only)
- Battery pack
- Motorcycle mount and hardware
- Motorcycle power cable
- Automotive suction cup mount
- Automotive power cable
- USB cable
- Quick start manual

Maps & Memory:

- Preloaded street maps (76000573 only)
- Internal solid-state memory
- MicroSD™ data card compatible
- 1,000 Waypoints/favorites/locations

Ride Planning Features:

- Trip Planner
- Trip Log
- Curvy Roads routing

Size & Specs:

- Physical dimensions: 5.12"W x 3.7"H x 1.18"D (13.0 x 9.4 x 3.0 cm)
- Display size: 4.25"W x 2.55"H (10.8 x 6.5 cm); 5.0" diag (12.6 cm)
- Display resolution: 800 x 480 pixels
- Weight: 13.2 ounces (374.5 g)
- Rechargeable lithium-ion battery
- Battery life: Up to 4 hours
- Headphone jack/audio line-out
- High-sensitivity receiver
- Water rating: IPX7

Navigation Features:

- Speaks street names
- Lane assist
- Junction view
- Route avoidance
- Bluetooth® wireless technology
- Speed limit indicator
- View upcoming POI along route
- Custom POIs

Additional Features:

- Reverse Round Trip Planning
- Service History Log
- Track Route Support
- Custom Map Support
- TOPO Map Support
- Pandora® Support

AUDIO & GAUGES 693

Navigation



B. ROAD TECH ZŪMO HANDLEBAR MOUNT KIT

B. ROAD TECH™ ZŪMO® HANDLEBAR MOUNT KIT

This installation kit is designed for handlebar mounting of the Road Tech™ zūmo® GPS system on specified Harley-Davidson® models. Replacing the left-hand half clamp, this sweeping chrome or gloss black bracket accepts the connection cradle for the Road Tech zūmo GPS system. Fits 1" and 1.25" handlebars.

Fits '02 VRSC™ (except VRSCF and VRSCR), '96-later XL (except XL883N and XL1200N), and XR, '96-'17 Dyna®, '96-later Softail®, and '96-later Road King® '97-'13 Road Glide® and '14-later Touring and Trike models equipped with Road Tech zūmo 590, 660 or 665 GPS units. XL and XR models require separate purchase of (2) Screw P/N 4669M. Does not fit with Road Tech Satellite Radio, Left-Hand Auxiliary Switch Housing or Clutch Lever Bracket Clamp Clock or Thermometer. Must be wired on exterior of handlebar.

76000191B	Chrome.	\$134.95
76000192B	Gloss Black.	\$134.95



B. ROAD TECH ZŪMO HANDLEBAR MOUNT – CHROME



B. ROAD TECH ZŪMO HANDLEBAR MOUNT – GLOSS BLACK

C. ROAD TECH ZŪMO FAIRING MOUNT KIT

This installation kit is designed to allow fairing mounting of the Road Tech zūmo GPS System on specified Harley-Davidson models. Positioned for convenient viewing by both the rider and passenger, the Mounting Kit easily accepts the slide-in connection cradle for the Road Tech zūmo 590/660/665 GPS System. Kit includes bracket and all required hardware. Installation requires drilling through inner fairing.

92238-09 **\$49.95**
Fits '96-'13 Electra Glide®, Street Glide® and Trike models equipped with Road Tech zūmo 590, 660 or 665 GPS unit. Does not fit with Road Tech SiriusXM® Satellite Radio P/N 76390-05A, '06-'10 CVO™ Electra Glide models or models equipped with Fairing Dash Pad P/N 58262-05.

D. ROAD TECH NAVIGATION INTERFACE MODULE

Available exclusively for Harley-Davidson Road Tech zūmo Navigation Systems. The Navigation Interface Module will provide an integrated link between the fairing-mounted Advanced Audio Radio and a Road Tech zūmo 590, 660 or 665 GPS Navigator. When linked, the music volume will automatically drop when a GPS spoken command is detected, allowing you to hear the instructions through the radio speakers or the 7-pin communications-style headset. The module attaches directly to the radio and is concealed within the fairing. Kit includes adaptor cable that permits stereo sound from the zūmo unit's internal MP3 player or SiriusXM radio if connected into radio's AUX input.

76000024A **\$174.95**
Fits '06-'13 Touring models (except '12 FLHXSE and '13 FLTRXSE) equipped with the Advanced Audio system and a Road Tech zūmo 660 GPS Navigator P/N 92115-09A, Road Tech zūmo 665 GPS Navigator P/N 76000014A or Road Tech zūmo 590 Navigator P/N 76000573. '11 FLHXSE and '12 FLTRXSE models require separate purchase of CVO Speaker Expansion Kit P/N 76000275. '06-'13 FLHTC, FLHX, FLTR and FLTRX models and those not equipped with Wiring Harness P/N 70169-06 require the separate purchase of Connector Kit P/N 69200033. Does not fit with Advanced Audio Hands Free Cell Phone Kit P/N 76408-06.

E. MUSIC PLAYER TANK POUCH

This portable music system pouch is designed for motorcycle use. The neoprene jacket offers hard-core protection for your portable music device, while the built-in magnets hold the pouch securely to the fuel tank. The clear play-through window permits touch-screen control and the anti-skid interior allows the pouch to accommodate players of various sizes. The clamshell design makes inserting your player into the pouch quick and easy and the double zipper allows for headphone and output cables to exit the pouch at any point on top, bottom or one side of the pouch. Simply plug in your headphones or connect your in-dash Advanced Audio Radio with an auxiliary cable or iPod® Interface and enjoy your music collection. Works well with many MP3 and other personal music players, but should not be used with hard-disk memory players. Window measurement: 2.25" W x 4.0" H.

76000193 **\$44.95**
Fits models with steel fuel tanks or airbox covers.



C. ROAD TECH ZŪMO FAIRING MOUNT KIT



D. ROAD TECH NAVIGATION INTERFACE MODULE



E. MUSIC PLAYER TANK POUCH

Model Family Fitment:

V-ROD	SPORTSTER	DYNA
SOFTAIL	TOURING	

Notice: The prices appearing in this catalog are the manufacturer's suggested retail prices. Actual retail prices may vary.

694 AUDIO & GAUGES

Electrical Accessories

A. AUXILIARY POWER PORT – HANDLEBAR MOUNT

Ideal for powering handlebar-mounted accessories, this elegant cast housing securely clamps to the handlebar to keep your power port within easy reach.

Fits '15-later XG, '14-later XL, '12-'17 Dyna®, '11-later Softail® (except FXDRS), and '14-later Road King® models with either 1" or 7/8" diameter handlebars. '17-later Road King requires separate purchase of Electrical Connection Kit P/N 69201599A. '18-later Softail models require separate purchase of Electrical Connection Kit P/N 69201750.

69200971 Chrome. **\$94.95**

69200970 Black. **\$94.95**

Fits '12-'17 Dyna, '11-later Softail (except FXDRS), and '14-later Road King models with 1-1/4" diameter handlebars. '17-later Road King requires separate purchase of Electrical Connection Kit P/N 69201599A. '18-later Softail models require separate purchase of Electrical Connection Kit P/N 69201750.

69200855 Chrome. **\$94.95**

69200854 Black. **\$94.95**



A. AUXILIARY POWER PORT – HANDLEBAR MOUNT, CHROME



A. AUXILIARY POWER PORT – HANDLEBAR MOUNT, BLACK

B. AUXILIARY POWER PORT – HORN MOUNT

This fuse-protected power port is conveniently located in an easily accessible location just off the horn mount bracket.

69201136 **\$79.95**

Fits EFI equipped models equipped with a side-mount horn (except XG models and '17-later Touring and Trike models).

C. AUXILIARY POWER PORT – SIDE-PANEL MOUNT

Designed to fit into the leading edge of the Touring model's removable side panel cover.

69201099 **\$29.95**

Fits '14-later Touring and Trike models. '17-later models require separate purchase of Electrical Connection Kit P/N 69201599A.

91843-97 **\$29.95**

Fits '94-'13 Touring and Trike models.

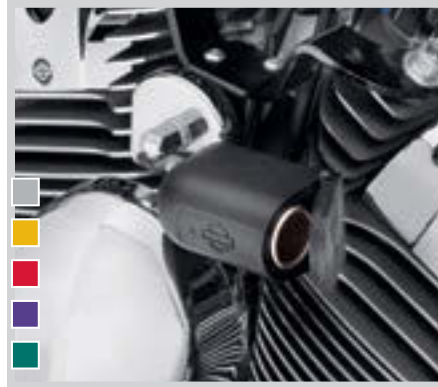

B. AUXILIARY POWER PORT – HORN MOUNT



C. AUXILIARY POWER PORT – SIDE-PANEL MOUNT

D. AUXILIARY POWER PORT – SADDLEBAG MOUNT

This convenient power port mounts to the inside wall of the saddlebag, allowing you to charge cell phones and music players in an out-of-site location.

69200091 **\$44.95**

Fits models equipped with 12-volt battery (except FXDRS, VRSC™, XG models, or with Throw-Over or Swingarm Bags). Not for use with accessory Fitted Liners or Premier Liners. Requires separate purchase of Battery Charging Harness P/N 94624-97B, if not already equipped.

E. AUXILIARY POWER PORT – TOUR-PAK® MOUNT

Easy access power port mounts to the wall of the Tour-Pak® luggage.

69200826 **\$40.95**

Fits '14-later FLHTCU, FLHTCUL, FLTRU and FLHTCUTG models. Original Equipment on FLHTK and FLHTKL.

91671-10 **\$49.95**

Fits '06-'13 FLHTC and FLTRU, '96-'13 FLHTCU and '09-'13 FLHTCUTG models. Also fits '06-'13 Touring models with accessory King Tour-Pak® luggage and '98-'13 Touring models with Tour-Pak mounted rear speaker pods. Not for use with Accessory Fitted Liners or Premier Liner.



D. AUXILIARY POWER PORT – SADDLEBAG MOUNT



E. AUXILIARY POWER PORT – TOUR-PAK MOUNT '14-LATER MODELS

F. USB CHARGING ADAPTOR

Charge your cell phone, MP3 players and other hand-held devices while on the road. Compact Adaptor plugs into standard or accessory 12-volt power ports and provides a standard USB-style outlet that accepts many phone and music player power cords.

69200357 **\$19.95**

For use with Original Equipment or accessory 12V Auxiliary Power Port.

G. EXTENDED USB CHARGING ADAPTER – 12V POWER PORT

Available in either 24" or 36" length. Maximum output: 5V/1A.

For use with Original Equipment or accessory 12V Auxiliary Power Port.

69201148 36.0". **\$24.95**



F. USB CHARGING ADAPTOR



G. EXTENDED USB CHARGING ADAPTER – 12V POWER PORT

Model Family Fitment:

- V-ROD
- SPORTSTER
- DYNA
- SOFTAIL
- TOURING

AUDIO & GAUGES 695

Electrical Accessories



H. 54-AMP HIGH OUTPUT CHARGING SYSTEM

H. 54-AMP HIGH OUTPUT CHARGING SYSTEM

The Harley-Davidson® High Output Charging System is engineered to provide 30% more power than the stock system at idle. With 54 amps of output at 4000 rpm, accessories will operate at their peak performance. This is a recommended installation anytime a multi-amp audio system is installed on the vehicle in order to achieve the full capability of your audio system. It is also recommended when installing heated seats, heated gear and other higher draw powered accessories.

Stock on select CVO™ Touring models, the complete kit includes high performance rotor, stator, voltage regulator and all gaskets and hardware required for installation.

29900028A **\$509.95**
Fits '11-'16 Touring, '10-'16 CVO Touring and '09-'16 Trike models. Stock on '14-'16 FLHTKSE, FLHXSE and FLTRUSE.

I. ELECTRICAL CONNECTION UPDATE KIT*

Harness plugs into accessory connector to provide 12-volt power leads.

69201599A **\$34.95**
Fits '18-later Softail® models and '17-later Touring and Trike models.

69200722 **\$29.95**
Fits '14-'16 Touring and Trike models.

69201750 **\$14.95**
Fits '18-later Softail models.

72673-11 **\$17.95**
Fits '14-later XL, '12-'17 Dyna® and '11-'17 Softail models.

J. SWITCHED CIRCUIT ADAPTER HARNESS*

Switch two accessories on or off simultaneously as required.

70264-94A **\$19.95**
Fits '94-later Touring and Trike models. Required on '14-later Touring and Trike models when connecting multiple powered accessories using Electrical Connection Kit P/N 69200722, 71400129, or 69201599A.

69201706 **\$24.95**
Fits '18-later Softail models and '17-later Touring and Trike models. Required when connecting the CoolFlow™ Fan and another powered accessory using Electrical Connection Kit P/N 69201599A.

K. ELECTRICAL ACCESSORY ADAPTER*

70270-04A **\$15.95**
Fits '07-later VRSC™, '04-'13 XL and XR, '04-'11 Dyna, '04-'10 Softail and '04-'13 Touring models. Also fits '14-later Touring and Trike when equipped with a third or fourth pair of Boom!™ Audio Stage II speakers.

L. 12V TO SAE 2-PIN POWER HARNESS

Use a standard 12V power port to power air pumps or other accessories that utilize the SAE 2-pin power connection. 24" length.

69201146 **\$24.95**
For use with Original Equipment or accessory 12V Auxiliary Power Port.

M. SAE 2-PIN TO USB ADAPTER

Mini harness converts SAE style connection used on battery tender cables to the common USB connection required to power many phone and music players.

69201149 **\$29.95**
Fits H-D® 12V Battery Charging Harnesses.

N. SAE 2-PIN Y-HARNESS

Mini 1-into-2 Y-harness allows two connections to the battery tender harness, permitting simultaneous battery charging and powering of personal electronics or air pumps.

69201150 **\$19.95**
Fits H-D 12V Battery Charging Harnesses.

*NOTE: It is possible to overload your motorcycle's charging system by adding too many electrical accessories. If your combined electrical accessories operating at any one time consume more electrical current than your vehicle's charging system can produce, the electrical consumption can discharge the battery and cause vehicle electrical system damage. Ask your dealer for advice about the amount of current consumed by additional electrical accessories.

Notice: The prices appearing in this catalog are the manufacturer's suggested retail prices. Actual retail prices may vary.

AUDIO & GAUGES



I. ELECTRICAL CONNECTION UPDATE KIT – (69201599A SHOWN)



J. SWITCHED CIRCUIT ADAPTER HARNESS



K. ELECTRICAL ACCESSORY ADAPTER



L. 12V TO SAE 2-PIN POWER HARNESS



M. SAE 2-PIN TO USB ADAPTER



N. SAE 2-PIN Y-HARNESS

696 AUDIO & GAUGES

Speedometers/Tachometers

COMBINATION SPEEDOMETER/TACHOMETER

Maintain the clean view over the handlebar. This unique Combination Speedometer/Tachometer allows you to monitor engine speed without adding additional handlebar-mounted gauges. The unit mounts in the stock dash opening and is a direct plug-in installation. The backlit gauges include a large LCD (liquid crystal display) information screen that displays odometer/tripmeter data, miles-to-empty readings, an easy-to-read segmented fuel display, a gear position indicator and clock. This valuable information is available to the rider at a glance. The gauge features push-button adjustable backlighting with over 600 color tone options, allowing the rider to adjust pointer, LCD and backlighting colors to match any paint scheme or viewing preference.

NOTE: As a result of different Original Equipment capabilities, the following exceptions apply: Gear position not available on '04-'07 models, Fuel functions are not available on '04-'06 XL, '04-'08 Dyna®, '04-'07 Softail® and '04-'07 Road King® models.

A. ANALOG SPEEDOMETER/TACHOMETER – 5"

Gauges feature speedometer and tachometer pointers that sweep clockwise to provide a "gauge within a gauge" look. Kit includes a data transfer cable to easily upload initial mileage at time of installation.

Fits '04-'11 Dyna, '04-'10 Softail (except FLSTSE) and '04-'13 Road King models (except '07-'08 FLHRSE) equipped with a 5" Speedometer.

70900070B	Spun Aluminum Dial, MPH.	\$314.95
70900071A	Spun Aluminum Dial, km/h.	\$314.95
70900072A	Spun Aluminum Dial, MPH/km/h.	\$314.95

Fits '12-'17 Dyna, '11-'17 Softail (except '11-'12 FLSTSE) and '14-later FLHR, FLHRC and FLHRXS models with a 5.0" Speedometer.

74774-11C	Spun Aluminum Dial, MPH.	\$314.95
74775-11B	Spun Aluminum Dial, km/h.	\$314.95
70900171B	Spun Aluminum Dial, MPH/km/h.	\$314.95
74776-11C	Black Dial, MPH.	\$314.95
74777-11B	Black Dial, km/h.	\$314.95

B. DIGITAL SPEEDOMETER/ANALOG TACHOMETER – 4"

The digital speed reading can be easily toggled between MPH and kph to simplify cross-border travel. Mileage reinstatement resides in the vehicle ECM so initial mileage will be uploaded at the time of installation.

70900475 Spun Aluminum Dial, MPH/km/h. **\$314.95**
U.S. models. Fits '14-later XL, '12-'17 Dyna and '11-'17 Softail models equipped with 4" speedometer. XL models require separate purchase of Fuel Sensor Kit P/N 61200008A to make use of the fuel level and range function.

70900100C Spun Aluminum Dial, MPH/km/h. **\$314.95**
Non-U.S. models. Fits '14-later XL, '12-'17 FXDB and FXDWG, '11-'17 FXCWC, FXS and FXSB models equipped with 4" speedometer. XL models require separate purchase of Fuel Sensor Kit P/N 61200008A to make use of the fuel level and range function.

70900274 Spun Aluminum Dial, MPH/km/h. **\$314.95**
Worldwide Models. Fits '04-'13 XL (except XR, XL50 and '04-'08 XL1200R), '04-'11 Dyna models with 4" speedometer and '08-'10 FXCW and FXCWC models. '07-'13 XL models require separate purchase of Fuel Sensor Kit P/N 61200008A to make use of the fuel level and range function. Does not fit XL883 models equipped with Screamin' Eagle® 120Occ Stage I Conversion Kit P/N 29784-07 and 30003-10.

Also available:

FUEL LEVEL SENSOR KIT

In-tank sending unit employs capacitive sensing technology to accurately monitor the fuel level and relays the information to the Speedo/Tach LCD display for at-a-glance viewing. Kit includes sending unit, wiring harness and all necessary installation hardware.

61200008A **\$139.95**
Fits '07-later XL models equipped with Combination Digital Speedometer/Analog Tachometer P/N 70900274, 70900100C or 70900475.



A. COMBINATION ANALOG SPEEDOMETER/TACHOMETER – 5" SPUN ALUMINUM DIAL



A. COMBINATION ANALOG SPEEDOMETER/TACHOMETER – 5" BLACK DIAL



B. DIGITAL SPEEDOMETER/ANALOG TACHOMETER – 4" SPUN ALUMINUM DIAL

Notice: The prices appearing in this catalog are the manufacturer's suggested retail prices. Actual retail prices may vary.

AUDIO & GAUGES 697

Gear Indicator & Gauges



C. SPUN ALUMINUM FACE SPEEDOMETER



C. SPUN ALUMINUM FACE SPEEDOMETER

Add a touch of luxury and style to your dash. First featured on the '04 Screamin' Eagle® Deuce™ and Electra Glide® motorcycles, these spun aluminum metal-faced gauges offer a rich contrast to a chrome console or black inner fairing surface. The gauges feature subtle Harley-Davidson® racing orange backlighting for a unique nighttime look. Mileage reinstatement is available through your Dealer.

Fits '04-'06 FXDWG, '06 FXD35, '07 FXDC and '04-'06 Softail® and Road King® models.

67313-05A 5" Speedometer – MPH. **\$204.95**

67315-05A 5" Speedometer – km/h. **\$204.95**

D. DIGITAL GEAR INDICATOR

What gear am I in right now? Eliminate the guesswork with a Digital Gear Indicator. Conveniently located on the handlebar for line-of-sight viewing, the bright LED display is easy to read with a quick glance. When the clutch is out, the display indicates the current gear 1-6 or a large N when the transmission is in the neutral position. Easy to install, this plug & play Gear Indicator requires no wire splicing or complicated programming. A built-in photocell automatically adjusts the display for improved visibility in direct sunlight and dims the display at night to reduce distraction. Available in satin black finish. The complete kit includes a self-contained LED and control module, control housing, wiring harness and required mounting hardware. Switch housing can accept one additional auxiliary switch (sold separately).

70900078 Satin Black. **\$219.95**

Fits '07-'17 VRSC™ (except VRSCF), '07-'13 XL and XR, '07-'11 Dyna®, '07-'10 Softail and '07-'13 Touring models. '07-'08 XL1200 models require update calibration. Does not fit XL883 models equipped with Screamin' Eagle® 1200CC Stage I Conversion Kits P/N 29784-07 and 30003-10. Also, does not fit with Boom!™ Audio Cruiser Amp and Speaker Kits P/N 76262-08A, 76320-08A or 76321-09A.

E. TACH KIT FOR SPORTSTER® MODELS

Upgrade your XL883 to dual instruments. The kit includes an electronic tachometer, wrinkle-black dual gauge mounting bracket and hardware required for installation. Tachometer graphics complement Original Equipment speedometer and brackets allow for installation of your stock indicator lights.

67182-07 **\$336.95**

Fits '07-'08 XL883, '07-'10 XL883L and '07-later XL883R models. Stock on '07-'08 XL1200R models.



D. DIGITAL GEAR INDICATOR – SATIN BLACK



E. TACH KIT FOR SPORTSTER MODELS



Model Family Fitment:

- V-ROD
- SPORTSTER
- DYNA
- SOFTAIL
- TOURING

Notice: The prices appearing in this catalog are the manufacturer's suggested retail prices. Actual retail prices may vary.

698 AUDIO & GAUGES

Fairing Mount Gauges

A. CUSTOM FACE GAUGES

Add a rich, custom look to your dash. First featured on the '14-'15 CVO™ models, these chrome-accented gauges feature backlighting and large, easy-to-read numbers for at-a-glance viewing. Gauges are plug-in ready and require no additional splicing or re-wiring for installation. Mileage reinstatement is available through your Dealer.

Fits '14-later Electra Glide®, Road Glide®, Street Glide® and Ultra Limited models. Original Equipment on some CVO models.

70900773	Speedo/Tach Cluster – MPH.	\$647.47
70900777	Speedo/Tach Cluster – km/h.	\$283.56
70900778	Speedo/Tach Cluster – MPH/km/h.	\$647.47
70900774	Fuel Gauge.	\$150.21
70900775	Voltmeter.	\$129.50



A. CUSTOM FACE GAUGES

B. SPUN ALUMINUM FACE GAUGES

Add a touch of luxury and style to your dash. First featured on the '04 Screamin' Eagle® Deuce™ and Electra Glide models, these Spun Aluminum Face Gauges offer a rich contrast to a chrome console or black inner fairing surface. The gauges feature subtle Harley-Davidson® racing orange backlighting for a unique nighttime look. Mileage reinstatement is available through your Dealer.

67516-08	4" Speedometer – MPH.	\$204.95
Fits '08-'13 Electra Glide and Road Glide models equipped with 4" gauges.		
67516-04B	4" Speedometer – MPH.	\$204.95
Fits '04-'07 Electra Glide and Road Glide models equipped with 4" gauges.		
67522-04B	4" Tachometer.	\$246.95
Fits '04-'13 Electra Glide and Road Glide models and '04-later XL and Dyna® models equipped with 4" gauges.		
74552-04A	Voltmeter.	\$89.95
Fits '04-'13 Electra Glide, Road Glide and Trike models.		
75113-04A	Fuel Gauge.	\$89.95
Fits '04-'07 Electra Glide and Road Glide models.		
75113-08	Fuel Gauge.	\$89.95
Fits '08-'13 Electra Glide and Road Glide models.		
74553-04A	Oil Pressure Gauge.	\$89.95
Fits '04-'13 Electra Glide, Road Glide and Trike models. FLHT and FLHTI models require purchase of additional service parts for installation. See your Dealer for details.		
74554-04	Air Temperature Gauge.	\$54.95
Fits '04-'13 Electra Glide, Road Glide and Trike models. FLHT and FLHTI models require purchase of additional service parts for installation. See your Dealer for details.		



B. SPUN ALUMINUM FACE GAUGES

C. TITANIUM FACE GAUGES

Add a rich, custom look to your dash. First featured on the '10 FLHTK Ultra Limited model, these black and icy cool titanium numbered gauges feature white backlighting and large, easy-to-read numbers for at-a-glance viewing. Gauges are plug-in ready and require no additional splicing or re-wiring for installation. Mileage reinstatement is available through your Dealer.

74682-10	4" Speedometer – MPH.	\$189.95
74683-10	4" Speedometer – km/h.	\$189.95
74692-10	4" Tachometer.	\$159.95
74688-10	Fuel Gauge.	\$69.95
74689-10	Air Temperature Gauge.	\$69.95
74690-10	Oil Pressure Gauge.	\$69.95
74691-10	Voltmeter.	\$69.95
70900176	Oil Temperature – Fahrenheit.	\$149.95



C. TITANIUM FACE GAUGES

Notice: The prices appearing in this catalog are the manufacturer's suggested retail prices. Actual retail prices may vary.

AUDIO & GAUGES 699

Oil Pressure Gauges



D. DIGITAL OIL PRESSURE GAUGE – CHROME



D. DIGITAL OIL PRESSURE GAUGE – CHROME

Keep an eye on your engine's vital signs. This Oil Pressure Gauge features a brilliant blue, easy-to-read digital display that shines through a mirror-coated glass when the ignition is turned on. The readout is invisible when not in use. A photocell automatically adjusts the display's brightness to improve visibility in direct sunlight or to dim the display at night to avoid distraction. The display can be toggled between PSI and BAR pressure readings. Kit includes die-cast mounting bracket with gauge, pressure sensor and wiring harness.

75138-09 \$249.95

Fits '99-'17 Dyna®, '00-'17 Softail®, '99-'16 Road King®, Electra Glide® Standard and Freewheeler® models. Also fits '99-'16 Electra Glide Classic, Ultra Classic®, Ultra Limited and Tri Glide® models if original oil pressure gauge is disconnected. Does not fit with Billet Rocker Box Covers P/N 17658-03, Burst Rocker Box Covers P/N 25700251, Mid-Frame Air Deflectors P/N 58022-07A or 58170-09 or models equipped with Sidecars. '12-'17 Dyna and '11-'17 Softail models require separate purchase of Electrical Connection Kit P/N 72673-11. '14-'16 Touring models require separate purchase of Electrical Connection Kit P/N 69200722.

E. OIL PRESSURE GAUGE KIT

Check your oil pressure at a glance with this oil-filled Pressure Gauge Kit, specifically designed to look good, fit right and perform properly on your Twin Cam-equipped motorcycle. The custom mounting brackets have been polished and chrome-plated to rigid Harley-Davidson standards and the gauge offers premium reliability. The kit includes all necessary hardware and mounting brackets for quick and clean installation.

75133-99 \$109.95

Fits '99-'05 Dyna, '00-'17 Softail, '99-'13 FLHR and '99-'05 FLHT models. Does not fit with Billet Rocker Box Cover P/N 17658-03.

F. LIQUID-FILLED OIL PRESSURE GAUGE

Contains special non-yellowing fluid that dampens the internal movement for improved gauge reliability. Incorporates corrosion-resistant stainless steel bezel and includes Harley-Davidson Bar & Shield graphics that match various late model instruments. Complete with chrome-plated steel fittings and O-rings for crankcase installation. New mounting design prevents damage from improper installation.

75012-82D \$69.95

Fits '82-'84 Shovelhead and '84-later Evolution® 1340-equipped models.

G. OIL TEMPERATURE GAUGE – FAIRING MOUNT

Keep a close eye on your engine's vital signs. This 2.0" diameter gauge monitors engine oil temperature to provide an early warning of conditions that may require attention. The gauge face is styled to complement Original Equipment fairing mount gauges. Complete kit includes gauge, installation hardware and wiring harness.

Fits '99-'13 FLHT, FLHTC, FLHTCU, FLHX, FLTR and Trike models. Does not fit '09-later CVO™ models.

1. 70900284 Silver Face – Fahrenheit. \$149.95

2. 70900283 Black Face – Fahrenheit. \$149.95

Fits '08-'13 Touring models (except Road King) and Trike models.

3. 70900176 Titanium Face – Fahrenheit. \$149.95



E. OIL PRESSURE GAUGE KIT



F. LIQUID-FILLED OIL PRESSURE GAUGE



G. OIL TEMPERATURE GAUGE – FAIRING MOUNT

Model Family Fitment:

- V-ROD
- SPORTSTER
- DYNA
- SOFTAIL
- TOURING

Notice: The prices appearing in this catalog are the manufacturer's suggested retail prices. Actual retail prices may vary.

700 AUDIO & GAUGES

Gauge Trim

A. GAUGE BEZELS – DEFIANCE COLLECTION

The perfect finishing touch. Defiance Collection Gauge Bezels add a custom detail to the place you constantly look – your instrument cluster. Accented with deep grooves, these machined aluminum rings cover the factory gauge surround adding texture and visual interest to the dash. Available in chrome, gloss black or machine cur black finishes, these self-adhesive rings are easy to install.

Fits '99-later XL (except XL1200CX, XL1200X and XL1200XS), '11-'13 FXS, '13-'17 FXSB, '13-'14 FXSBSE, '98-'13 Road Glide®, '14-'17 FXDL, and '18-later FXFB, FXFBS and FXLR models.

61400435	4" Tank Gauge – Chrome.	\$69.95
61400436	4" Tank Gauge – Black Machine Cut.	\$74.95
61400437	4" Tank Gauge – Black Anodized.	\$69.95

Fits '18-later FLDE, FLHC, FLHCS, and FLSL models.

61400438	5" Tank Gauge – Chrome.	\$54.95
61400439	5" Tank Gauge – Black Machine Cut.	\$59.95
61400440	5" Tank Gauge – Black Anodized.	\$54.95

B. GAUGE VISOR RING

A touch of chrome makes all the difference. These easy-to-install trim rings feature an integrated eyebrow visor to shield the gauge face from the sun's glare. Self-adhesive backing for secure mount.

74661-04 5.0" Gauge. **\$27.95**

Fits '12-'16 FLD, '99-'08 FXDWG, '15-'17 FXDF, '99-'17 Softail® (except FLSTFSE, FLSTNSE, FXCW, FXCWC, FXS, FXSB, FXSBSE, FXSE, FXST-Aus, FXSTD and models equipped with Chrome Console P/N 67575-04), '18-later FLSL, FLDE, FLHC and FLHCS and '99-'07 Road King® models.

C. INSTRUMENT GAUGE BEZEL

A touch of chrome makes all the difference. These bezel covers take just seconds to install and add the beauty of chrome to your dash. Available to fit all the fairing-mount gauges, these easy-to-install, chrome-plated formed rings feature peel-and-stick adhesive backing for permanent installation.

74541-00 4.0" Gauge. **\$16.95**

Fits Speedometer and Tachometer Gauges on '00-later XL, '00-'13 Dyna® (except FLD and FXDWG), '13-'17 FXSB, FXSBSE and FXST-Aus and '00-'13 Electra Glide®, Street Glide®, Road Glide and Trike Models (sold individually).



**A. GAUGE BEZELS – DEFIANCE COLLECTION
(5" BLACK MACHINE CUT SHOWN)**



**A. GAUGE BEZELS – DEFIANCE COLLECTION
(4" BLACK MACHINE CUT SHOWN)**



A. GAUGE BEZELS – DEFIANCE COLLECTION



B. GAUGE VISOR RING – 5" GAUGE



C. INSTRUMENT GAUGE BEZEL – 4" GAUGE

Model Family Fitment:

- V-ROD
- SPORTSTER
- DYNA
- SOFTAIL
- TOURING

Notice: The prices appearing in this catalog are the manufacturer's suggested retail prices. Actual retail prices may vary.

AUDIO & GAUGES 701

Fuel Caps & Gauges



D. FLUSH-MOUNT FUEL CAP AND GAUGE KIT – CHROME



D. FLUSH-MOUNT FUEL CAP AND GAUGE KIT – GLOSS BLACK



D. FLUSH-MOUNT FUEL GAUGE – FULL



D. FLUSH-MOUNT FUEL CAP – GLOSS BLACK



E. FLUSH-MOUNT FUEL CAP – CHROME



D. FLUSH-MOUNT FUEL CAP AND GAUGE KIT*

Emphasize the long and lean look of the fuel tank. This Flush-Mount Fuel Cap and Gauge Kit offers a pop-up filler design that when installed and sealed looks identical to the flush gauge. A simple push and the fuel filler cap pops up to provide ample grip, even while wearing gloves. The flush fuel gauge features individual LED lamps that shine through a mirror-coated glass that glows when the ignition is switched on. A photocell automatically adjusts LED brightness for improved visibility in direct sunlight and dims at night to avoid distraction. Complete kit includes fuel cap, fuel gauge, trim ring and plug-in wiring harness.

Fits '09-'17 Dyna® models (except FXD).

62910-09C	Chrome.	\$209.95
75327-09C	Gloss Black.	\$209.95

Fits '04-'08 FXD35, FXDB, FXDL and FXDWG and '07-'08 FXDC and FXDF models.

62910-06C	Chrome.	\$209.95
------------------	---------	-----------------

Fits '08-'17 Softail® (except FLSTNSE, FXCW, FXCWC, FXS, FXSB, FXSBSE and FXSE). '08-later Road King® and '15-later Freewheeler® models.

62823-08C	Chrome.	\$209.95
75027-08C	Gloss Black.	\$209.95

Fits '08-'11 FXCW and FXCWC models.

62811-08C	Chrome.	\$209.95
------------------	---------	-----------------

Fits '04-'06 carbureted and '01-'07 fuel injected Softail models (except FXSTD/I).

62818-06F	Chrome.	\$209.95
75014-06C	Gloss Black.	\$209.95

Fits '04-'07 Road King models.

62823-06C	Chrome.	\$209.95
------------------	---------	-----------------

*Some local regulations prohibit using colored lights during vehicle operation on public streets. May not conform to local lighting regulations.

E. FLUSH-MOUNT FUEL CAPS

Emphasize the long and lean look of the fuel tank. This Flush-Mount Fuel Cap Kit offers a pop-up filler design that replaces the Original Equipment twist-on fuel cap. A simple push and the fuel filler cap pops up to provide ample grip, even while wearing gloves. Easy to install, the cap assembly screws into position and the self-adhesive decorative ring finishes the look. Complete kit includes screw-in mount, pop-up cap and matching trim ring.

Fits '98-later XL models equipped with 3.3 gal (12.5 L) fuel tank.

63133-10A	Chrome.	\$79.95
63134-10A	Gloss Black.	\$79.95

Fits '98-later XL models equipped with 2.1 gal (7.9 L) or 4.5 gal (17.0 L) fuel tank. Does not fit '04-'10 XL1200C models.

63139-10A	Chrome.	\$79.95
63140-10A	Gloss Black.	\$79.95

Fits '11-'17 FLSTNSE, FXS, FXSB, FXSBSE and FXSE models.

61100006A	Chrome.	\$79.95
61100007A	Gloss Black.	\$79.95

Notice: The prices appearing in this catalog are the manufacturer's suggested retail prices. Actual retail prices may vary.

702 AUDIO & GAUGES

Fuel Caps

A. CUSTOM FUEL CAPS

Add a custom touch to your tank. Styled to reflect your attitude, these elegantly constructed fuel caps are the perfect match for your ride. The fuel cap is easy to install and features a ratcheting design to ensure that the design faces the correct direction.

Fits '92-later XL, '92-'17 Dyna® (except '04-'17 FXD and FXDX, '05-'06 FXDC and '07 FXDSE), '00-later Softail®, (except FXFB, FXFBS, FXSTD and FXSTSSE) '94-later Road King® and '15-later Freewheeler® models. Does not fit models equipped with Original Equipment locking or tethered fuel caps or Softail models with Low-Profile Chrome Fuel Tank Console P/N 71208-07. Use on '13-'14 FXSBSE requires removal of stock flush mount trim ring.

61100107	Dominion™ Black.	\$89.95
61100106	Dominion Bronze.	\$89.95
61100093	Gloss Black.	\$34.95
61100076	Brass Collection.	\$119.95
61100126	Diamond Black.	\$49.95
61100127	Agitator.	\$99.95
61100128	Chisel.	\$69.95

Also available:

LEFT SIDE FUEL TANK CAPS

Styled to match the custom right-side fuel cap, this left-side decorative tank cap proudly completes your custom look. The easy-to-install cap replaces the Original Equipment trim, and provides the rider with a symmetrical view over the tank.

Fits '18-later Softail models (except FXBB, FXBR, FXBRS, FXDRS, FXFB and FXFBS).

57300186	Dominion Black.	\$89.95
57300185	Dominion Bronze.	\$89.95
57300236	Gloss Black.	\$34.95
57300165	Brass Collection.	\$119.95
57300151	Diamond Black.	\$49.95
57300150	Agitator.	\$99.95
57300149	Skull.	\$49.95



A. CUSTOM LEFT & RIGHT FUEL CAPS – DOMINION BLACK



A. CUSTOM FUEL CAP – DOMINION BRONZE



A. CUSTOM FUEL CAP – GLOSS BLACK



A. CUSTOM FUEL CAP – BRASS COLLECTION



A. CUSTOM FUEL CAP – DIAMOND BLACK



A. CUSTOM FUEL CAP – AGITATOR



A. CUSTOM FUEL CAP – CHISEL

Notice: The prices appearing in this catalog are the manufacturer's suggested retail prices. Actual retail prices may vary.

AUDIO & GAUGES 703

Fuel Caps



B. CUSTOM FUEL CAP – SKULL



B. CUSTOM FUEL CAP – SKULL

B. CUSTOM FUEL CAP – SKULL

Add a little attitude to your ride. Styled to complement Harley-Davidson® Skull accessory items, the menacing raised skull with black-filled eyes features a rich finish and a styled shape that is easy to grip, even while wearing gloves.

Fits '92-later XL, '92-'17 Dyna® (except '04-'17 FXD, FXDX, '05-'06 FXDC and '07 FXDSE), '00-later Softail® (except FXFB, FXFBS, FXSTD, and '07-'08 FXSTSSE), '94-later Road King® '15-later Freewheeler® models. Does not fit models equipped with Original Equipment locking or tethered fuel caps or Softail models with Low-Profile Chrome Fuel Tank Console P/N 71208-07. Use on '13-'14 FXSBSE requires removal of stock flush mount trim ring.

61100103	Gloss Black.	\$59.95
61100125	Chrome.	\$59.95

C. BAR & SHIELD LOGO SELF-LOCKING FUEL CAP

Functional and stylish, these polished, chrome-plated caps feature a convenient self-locking mechanism and a stamped Harley-Davidson Bar & Shield logo on the key hole cover. Maintains the same features as the Original Equipment fuel cap. The kits come complete with two keys.

Fits '92-later XL, '92-'17 Dyna (except '04-'17 FXD and FXDX, '05-'06 FXDC and '07 FXDSE), '00-later Softail (except FXS), '94-later Road King and '15-later Freewheeler models. Does not fit models equipped with Original Equipment locking or tethered fuel caps. Use on '13-'14 FXSBSE requires removal of stock flush mount trim ring.

61100117	Gloss Black.	\$59.95
61100129	Chrome.	\$54.95



C. BAR & SHIELD LOGO SELF-LOCKING FUEL CAP – GLOSS BLACK



C. BAR & SHIELD LOGO SELF-LOCKING FUEL CAP – CHROME

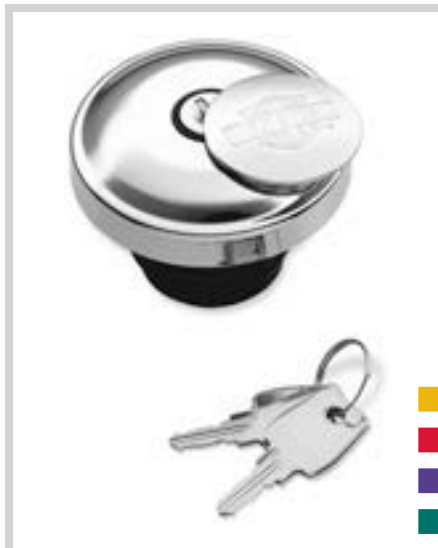

Model Family Fitment:

 V-ROD	 SPORTSTER	 DYNA
 SOFTAIL	 TOURING	

Notice: The prices appearing in this catalog are the manufacturer's suggested retail prices. Actual retail prices may vary.

704 AUDIO & GAUGES

Fuel Caps & Gauges

A. LED FUEL GAUGES*

This low-profile fuel gauge replaces the analog readout with bright LED lamps. The six edge-mounted LED lamps glow blue when the tank is full and extinguish one by one as fuel is consumed. Plug-in installation without splicing. Photocell automatically adjusts LED brightness for improved visibility in direct sunlight and dims at night to avoid distraction.

Fits '09-'17 Dyna® (except FXD), '08-'17 Softail® (except FLSTNSE, FXCW, FXCWC, FXS, FXSB, FXSBSE and FXSE), '08-'17 Road King® and '15-'17 Freewheeler® models.

75242-08A	Smooth.	\$149.95
70900781	Black Skull.	\$169.95
75098-08A	Chrome Skull.	\$169.95
70900521	Agitator.	\$199.95
70900354	Chisel.	\$179.95
75358-10A	Diamond Black.	\$149.95
70900709	Brass.	\$219.95

Fits '04-'08 FXD35, FXDB, FXDF, FXDL and FXDWG, '07-'08 FXDC, '04-'07 Softail, '01-'03 EFI Softail (except FXSTD1), '03-'07 Road King and '01-'02 EFI Road King models.

75357-10A	Diamond Black.	\$149.95
75237-03C	Smooth.	\$149.95

*Some local regulations prohibit using colored lights during vehicle operation on public streets. May not conform to local lighting regulations.



A. LED FUEL GAUGE – SMOOTH



A. LED FUEL GAUGE – BLACK SKULL

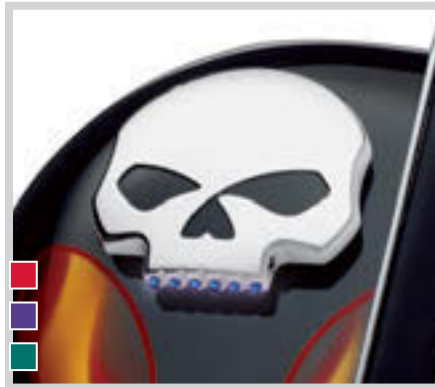

A. LED FUEL GAUGE – CHROME SKULL



A. LED FUEL GAUGE – AGITATOR



A. LED FUEL GAUGE – CHISEL



A. LED FUEL GAUGE – DIAMOND BLACK



A. LED FUEL GAUGE – BRASS COLLECTION



Model Family Fitment:

- V-ROD
- SPORTSTER
- DYNA
- SOFTAIL
- TOURING

Notice: The prices appearing in this catalog are the manufacturer's suggested retail prices. Actual retail prices may vary.

AUDIO & GAUGES 705

Medallions & Handlebar Gauges



B. FUEL CAP MEDALLION – DARK CUSTOM LOGO



B. FUEL CAP MEDALLION – WILLIE G SKULL



B. FUEL CAP MEDALLION – H-D MOTOR CO.



B. FUEL CAP MEDALLION – GOLD LIVE TO RIDE



C. HANDLEBAR CLOCK – 1.5" BLACK/CHROME



D. HANDLEBAR THERMOMETER – 1.5" BLACK



D. HANDLEBAR THERMOMETER – 1.5" SILVER



E. HANDLEBAR MOUNT CLAMP – CHROME

B. FUEL CAP MEDALLIONS

Top off your Original Equipment fuel cap. Adhesive backing for easy installation.

Fits '83-later models (except VRSC™, XG, XL1200V, FXD, FXDX, FXR with plastic fuel cap, FLTNSÉ, FXS, FXSB, FXSBSE, FXST-Aus, '18-later FXBB, FXDRS, FXFB, FXFBS, Electra Glide®, Road Glide®, Tour Glide™, Tri Glide®, '15-later XL883N, '04-'10 XL1200L and XL1200C, '08-later XR, '05-'06 FXDC and all fuel caps with gauges or locks).

99688-10	Dark Custom.	\$19.95
99670-04	Willie G Skull.	\$19.95
99539-97	H-D Motor Co.	\$16.95
99020-90T	Live To Ride.	\$26.95
99669-04	Willie G Skull.	\$19.95

Fits '04-'10 XL883C, XL1200C and XL1200L models.

C. HANDLEBAR CLOCK

Arrive on time without looking at your watch. These large diameter battery-powered analog clocks are easy to read at a glance and are available in your choice of chrome or black finish to complement your styling direction. Designed to mount to the clutch lever bracket, the waterproof clock is powered by a self-contained replaceable battery that makes installation a breeze. Kit includes clutch lever mounting bracket, but if you need to mount the clock on another area of the handlebar, select from the available Handlebar Clock Mount Clamps (sold separately).

Fits all models (except '15-later XG). Models equipped with reverse switch or Auxiliary Accessory Switch Housing Kits will require separate purchase of appropriate Handlebar Clock Mount Clamp.

75041-03	1.5" Black/Chrome.	\$74.95
75042-03	1.5" Silver/Chrome.	\$74.95

D. HANDLEBAR THERMOMETER

Designed to mount to the Brake Master Cylinder Clamp, this polished stainless steel temperature gauge will keep you in touch with the outside air temperature. Styled to match the Original Equipment gauge design and the Clutch Lever Bracket Clamp Clock, the thermometer is available with black or silver face. This waterproof gauge is simple to install. Kit includes clutch lever mounting bracket, but if you need to mount the clock on another area of the handlebar, select from the available Handlebar Clock Mount Clamps (sold separately).

Fits all models (except '15-later XG). Not for use with Auxiliary Accessory Switch Housing Kits.

75102-04	1.5" Black, Fahrenheit.	\$74.95
75104-04	1.5" Silver, Fahrenheit.	\$74.95
75108-06	1.5" Black, Celsius.	\$74.95
75115-06	1.5" Silver, Celsius.	\$74.95

E. HANDLEBAR MOUNT CLAMP

Position your Handlebar Clock or Temperature Gauge for quick and comfortable viewing. Custom hinged clamp firmly grips the handlebar and locks the clock or temperature gauge into position. Easy to install at your choice of location along the bar, this clamp provides an alternative mounting position if the handlebar control clamp bracket is occupied by other accessories like zūmo® GPS Navigator, Boom!™ Audio Cruiser Amp & Speaker Kit, Gear Indicators or Auxiliary Switch Housings.

Fits all models with 1 inch handlebars.

10800055	1.0" Chrome.	\$21.95
10800057	1.0" Black.	\$21.95

Fits all models with 1.25 inch handlebars.

10800056	1.25" Chrome.	\$23.95
10800058	1.25" Black.	\$23.95

Notice: The prices appearing in this catalog are the manufacturer's suggested retail prices. Actual retail prices may vary.

LIGHTING

See and be seen. With Harley-Davidson® Genuine Motor Parts and Accessories headlamps, brake lights and auxiliary lighting, you get improved visibility in front of you and more attention from all around you.





SPECTRA GLO™ RGB COLOR RANGE

YELLOW

GREEN

TEAL

BLUE

WHITE

PINK

RED

YELLOW



LIGHTING 709

LED Decorative Lighting



A. SPECTRA GLO LED LIGHTING CONTROLLER KIT – FOB

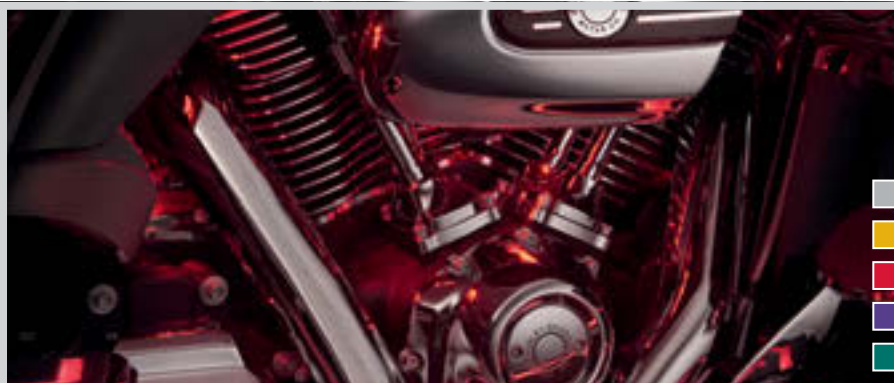

SPECTRA GLO LIGHTING
(RED SETTING SHOWN)



SPECTRA GLO LIGHTING
(GREEN SETTING SHOWN)



SPECTRA GLO LIGHTING
(BLUE SETTING SHOWN)

A. SPECTRA GLO™ LED LIGHTING CONTROLLER KIT*

Nothing draws attention at the curb like a well-lit bike. Whether you are looking for a rich neon glow or a pulsing crowd pleaser, the Harley-Davidson® Spectra Glo™ Lighting System brings ultra-bright LED lighting to your ride. The Spectra Glo System utilizes RGB LED technology to produce over 500 shades of brilliant color, all controllable with a waterproof handheld wireless fob. Simply use one button to select one of the 7 base colors, and then dial in the shade you desire. You can choose to match the color of your bike, or add a contrasting tone from the wide spectrum of colors. Once you select a color, you can choose between solid, flash or fade modes with a tap of the remote control.

At the core of the Spectra Glo system is the Lighting Controller. The compact waterproof controller box is hidden beneath the seat, and is activated with the included wireless remote fob. The Lighting Controller is the hub for all the added Spectra Glo light options, and syncs the color and mode selection between all the LEDs. Designed specifically for Harley-Davidson motorcycles, the controller will not interfere with the bike's electronics. The low draw LED lamps have a one-hour auto-shutoff feature to preserve the battery. Kit includes Controller, Remote Control Fob with battery, and plug-in wiring harness.

68000218 **\$99.95**

Required for use with Spectra Glo components. '18-later Softail® and '17-later Touring models require purchase of Vehicle Connection Kit P/N 69201526. All other vehicles require purchase of Vehicle Connection Kit P/N 69201636.

LIGHTING

*NOTE: Some local regulations prohibit using colored or indirect lighting during vehicle operation on public streets. Check local regulations before installation.

Model Family Fitment:

- | | | |
|-----------|-------------|--------|
| ■ V-ROD | ■ SPORTSTER | ■ DYNA |
| ■ SOFTAIL | ■ TOURING | |

Notice: The prices appearing in this catalog are the manufacturer's suggested retail prices. Actual retail prices may vary.

710 LIGHTING

LED Decorative Lighting

A. SPECTRA GLO™ LED LIGHT POD KIT*

Light Pods allow you to install general lighting almost anywhere on the bike. Ground-facing pod placement provides a neon-like pool of light on the pavement, and pods hidden below the tank or behind covers reflects into chrome surfaces to double the splash of color. These compact flexible pods feature connectors that allow the lights to be chained together in longer strips or placed individually and connected by jumper wires. Each pod features 3 individual RGB LEDs, and includes a tough adhesive backing for easy placement. Begin the installation with the 6-Lamp Starter Kit, and add on with one or more 4-Lamp Expansion Kits. Starter Kit includes 6 light pods, 4 – 3" jumpers, 1 – 8" jumper and 1 – 24" jumper. Expansion Kit includes 4 light pods, 3 – 3" jumpers, and 1 – 8" jumper.

68000213 6-Lamp Starter Kit. **\$149.95**
Fits all models. Requires separate purchase of Controller P/N 68000218. Additional alternate length harnesses are available (sold separately).

68000214 4-Lamp Expansion Kit. **\$99.95**
Fits all models equipped with an Spectra Glo™ Light Pod Kit. Additional alternate length harnesses are available (sold separately).

Also available: (not shown)

SPECTRA GLO WIRE HARNESS KIT

Required for installation of Spectra Glo Lighting System on specified models.

69201636 **\$24.95**
Required for installation of Spectra Glo Lighting System on all models (except '17-later Touring and Trike models.)

Also Available: (not shown)

SPECTRA GLO LIGHTING WIRING JUMPERS

These wiring harnesses are custom made for easy plug-and-play installation of Spectra Glo Light Pods. Plan your installation, and select the matching harness lengths to allow placement of light pods throughout the vehicle. No cutting or splicing is required.

Works with Spectra Glo Light Pod Base and Expansion Kits.

69201525 3" Jumper Harness. **\$9.95**
69201529 8" Jumper Harness. **\$14.95**
69201530 24" Jumper Harness. **\$19.95**
69201595 24" Jumper with Grommet. **\$19.95**
69201625 48" Jumper Harness. **\$24.95**
69201594 Y-Harness. **\$19.95**



A. SPECTRA GLO LED LIGHT POD KIT (RED SETTING SHOWN)



A. SPECTRA GLO LED LIGHT POD KIT (GREEN SETTING SHOWN)



A. SPECTRA GLO LED LIGHT POD KIT (BLUE SETTING SHOWN)



A. SPECTRA GLO LED LIGHT POD KIT (ORANGE SETTING SHOWN)



A. SPECTRA GLO LED LIGHT POD KIT – 6 LAMP STARTER KIT



A. SPECTRA GLO LED LIGHT POD KIT – 4 LAMP EXPANSION KIT

*NOTE: Some local regulations prohibit using colored or indirect lighting during vehicle operation on public streets. Check local regulations before installation.

Notice: The prices appearing in this catalog are the manufacturer's suggested retail prices. Actual retail prices may vary.



B. SPECTRA GLO LED FAIRING VENT LIGHT (RED SETTING SHOWN)



B. SPECTRA GLO LED FAIRING VENT LIGHT (BLUE SETTING SHOWN)



C. SPECTRA GLO FOOTBOARD INSERTS (BLUE SETTING SHOWN)



C. SPECTRA GLO FOOTBOARD INSERTS (ORANGE SETTING SHOWN)



D. SPECTRA GLO SPEAKER ILLUMINATION KIT – STAGE I SPEAKERS



D. SPECTRA GLO SPEAKER ILLUMINATION KIT – STAGE I SPEAKERS



D. SPECTRA GLO SPEAKER ILLUMINATION KIT – STAGE II SPEAKERS ROUND



D. SPECTRA GLO SPEAKER ILLUMINATION KIT – STAGE II SPEAKERS SADDLEBAG

B. SPECTRA GLO™ LED FAIRING VENT LIGHT*

Spectra Glo™ Fairing Vent Light fills the Batwing Split Stream Fairing Vent with a subtle glow. The 12 LED array mounts behind the fairing vent trim for a diffused look. The low profile lamp array does not block air flow and does not interfere with the vent function. Kit includes LED array, mounting template, installation hardware and wiring harness.

68000194 **\$109.95**
Fits '14-later Electra Glide®, Street Glide®, Ultra Limited, and Tri Glide® models.

C. SPECTRA GLO FOOTBOARD INSERTS*

Spectra Glo Rider and Passenger Footboard Inserts offer a unique look to the bike. Carved out of the slip-resistant rubber insert are LED illuminated bands that softly glow to match the selected Spectra Glo color. The rider board features an illuminated Bar & Shield logo, and the rider and passenger boards feature a rearward-sweeping band that ties the look together. Footboard Inserts fit Original Equipment or accessory traditional D-shaped footboard pans. Kits include left and right footboard insert and wiring harness.

50500492 Rider. **\$229.95**
Fits models with traditional D-shaped rider footboards. Does not fit '18-later Softail® models.

50500495 Passenger. **\$189.95**
Fits models with traditional D-shaped passenger footboards. Does not fit '18-later Softail models.

D. SPECTRA GLO™ SPEAKER ILLUMINATION KIT*

Nothing draws attention at the curb like a well-lit bike. Whether you are looking for a rich neon glow or a pulsing crowd pleaser, the Harley-Davidson® Spectra Glo Lighting System brings ultra-bright LED lighting to your ride. The Spectra Glo System utilizes RGB LED technology to produce over 500 shades of brilliant color, all controllable with a waterproof handheld wireless fob. Simply use one button to select one of the 7 base colors, and then dial in the shade you desire. You can choose to match the color of your bike, or add a contrasting tone from the wide spectrum of colors. Once you select a color, you can choose between solid, flash or fade modes with a tap of the remote control.

Spectra Glo Speaker Illumination adds a diffused neon glow to the Boom!™ Audio speakers. The compact LEDs are installed under the speaker bridge to provide a pool of light across the surface. Kits are available to fit Stage I and Stage II 6.5" Round Speakers and 5" x 7" Saddlebag Lid Speakers. Kits include two LED rings, mounting template and wiring harness.

68000232 Stage I Speakers. **\$174.95**
Fits '14-later Touring and Trike models with Boom! Audio 6.5" Stage I Round or 5" x 7" Stage I Saddlebag Speakers.

68000231 Stage II Speakers – Round. **\$199.95**
Fits '14-later Touring and Trike models with Boom! Audio 6.5" Stage II Round Speakers.

68000233 Stage II Speakers – Saddlebag. **\$199.95**
Fits '14-later Touring models with Boom! Audio 5" x 7" Stage II Saddlebag Speakers.

*NOTE: Some local regulations prohibit using colored or indirect lighting during vehicle operation on public streets. Check local regulations before installation.

Model Family Fitment:

- V-ROD
- SPORTSTER
- DYNA
- SOFTAIL
- TOURING

Notice: The prices appearing in this catalog are the manufacturer's suggested retail prices. Actual retail prices may vary.

712 LIGHTING

LED Decorative Lighting

A. ELECTRA GLO™ ILLUMINATED FAIRING ACCENT TRIM

Sweeping trim dresses the Electra Glide® Batwing Fairing for a distinctive, yet functional look. The contour-hugging spear and smoked lenses hide LED lamps that glow white as running lamps when the ignition is on and function as auxiliary amber sequential directional indicators when the turn signals are activated. The wiring is concealed inside the fairing for a clean, custom appearance. Complete kit includes mounting template and all necessary installation hardware. Trim may cover pinstripes or two-tone paint lines on some vehicles. Check appearance prior to installation.

Fits '14-later Electra Glide®, Street Glide®, Ultra Limited, and Tri Glide® models. Fitment on vehicles with two-tone paint, pinstriped, or CVO™ models is not recommended due to the potential for the accent lights to overlap pinstripes or paint lines.

68000190	Chrome.	\$299.95
68000191	Gloss Black.	\$299.95



A. ELECTRA GLO ILLUMINATED FAIRING ACCENT TRIM – RUNNING LIGHT

B. ELECTRA GLO™ FAIRING EDGE LIGHT KIT

Amplify your ride. The Electra Glo™ Fairing Edge Light kit adds forward-facing white LED accent lights to the front profile of your bike. Formed to follow the contour of the batwing fairing, the slim strip of lamps adds a strong visual element to the iconic shape of the Electra Glide model. The electrifying appearance adds conspicuity to get you noticed and the smoked housing conceals the lights and blends into the background when switched off. Simple “plug in” connections with no cutting or splicing of wires required.

68000104		\$99.95
-----------------	--	----------------

Fits '14-later Electra Glide, Street Glide, Ultra Limited and Tri Glide models. Separate purchase of Power Extension Harness P/N 69200921 is required if installed with Hidden AM/FM/WB Antenna P/N 76000513 or Electra Glo Light Rings.

68000035		\$99.95
-----------------	--	----------------

Fits '96-'13 Electra Glide, Street Glide and Trike models.



A. ELECTRA GLO ILLUMINATED FAIRING ACCENT TRIM – TURN SIGNAL

C. ELECTRA GLO ILLUMINATED WINDSHIELD TRIM

Smoked lenses hide bands of amber LED lamps that glow as running lamps when the ignition is on, and the two outer clusters function as auxiliary directional indicators when the turn signals are activated. The wiring is concealed inside the fairing for a clean, custom appearance. Complete kit includes all necessary mounting hardware.

Fits '14-later Electra Glide, Street Glide, Ultra Limited and Tri Glide models. Installation on CVO models requires removal of current windshield trim. Not for use with Three-Pocket Fairing Pouch P/N 93300054B.

57000394A	Chrome.	\$199.95
57000395A	Gloss Black.	\$199.95



B. ELECTRA GLO FAIRING EDGE LIGHT KIT

Model Family Fitment:

	V-ROD		SPORTSTER		DYNA
	SOFTAIL		TOURING		



C. ELECTRA GLO ILLUMINATED WINDSHIELD TRIM – GLOSS BLACK

Notice: The prices appearing in this catalog are the manufacturer's suggested retail prices. Actual retail prices may vary.

DAYMAKER® LED LIGHTING

Daymaker® LED Projector Headlamps were developed to provide light where you need it most. With a combination of superior nighttime performance and modern signature styling, these brilliant LED headlamps push out a bright-white beam that lights up the surroundings and draws the attention of oncoming traffic. The long-life, solid-state LED headlamps are housed in sealed shock and vibration-resistant lamp assemblies that mount into the existing light housing. Installation is simple, and the plug-in headlamps require no rewiring.

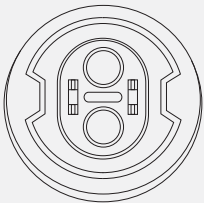

7" DAYMAKER PROJECTOR LED HEADLAMP

Offering best-in-class punch of light, these headlamps illuminate the road in front of you, yet are directed slightly downward to avoid blinding oncoming drivers, making them perfect for highway riding situations.

- Extensive engineering and testing to ensure the road in front of you is equally lit
- No dark spots or streaks in light illumination
- Plug and play headlamps can be installed easily

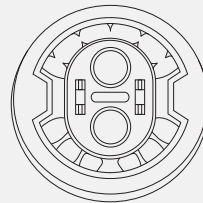

7" DAYMAKER ADAPTIVE LED HEADLAMP

Delivering the right amount of usable light exactly where you need it most – you will see ditch to ditch, and down the road with lean angle controlled bank lighting for improved line of sight through corners.

- Includes all features and benefits of the 7" Daymaker Projector LED Headlamp
- Automatically projects light into corners to illuminate areas of previously unlit road
- Patented sensors and electronics determine lean angle of the motorcycle
- Adaptive technology works in both low beam and high beam

The Daymaker LED Headlamps provide consistent road illumination by eliminating dark pockets and streaks, giving you a clear view of the road, and any hazards ahead.

Our adaptive technology adjusts with your lean angle, adding light to increase visibility through corners.

STANDARD LIGHT
 ADAPTIVE LIGHT

TURN / LEAN RIGHT	STRAIGHT	TURN / LEAN LEFT

LUMENS VS LUX

Lumen is a unit of light, while Lux is a unit of light measurement where the area is also taken into account. The number of Lumens is not the only factor when choosing a headlamp, but also the usable light, or Lux. The Daymaker LED Headlamps have been perfected to utilize both Lumens and Lux, giving you the best visibility of the road.

714 LIGHTING

Headlamps – LED

A. 7" DAYMAKER® ADAPTIVE LED HEADLAMP

The Daymaker® Adaptive Headlamp combines the best in headlight performance with the ultimate in modern styling. The projector-style LED offers best-in-class punch and spread with a pure white light that feels like riding during the day. Best yet, this headlamp features 12 LED spot lights that activate based on the lean of the bike and deliver curb-to-curb lighting that illuminates areas of the road unlit by traditional LED headlamps. Easy-to-install and extremely durable, the Daymaker Adaptive Headlamp provides functional perfection and exquisite styling all in one. DOT and ECE compliant for all markets.

Fits '12-'16 FLD, '04-'17 FLS, FLSS, FLSTC, FLSTF, FLSTFB, FLSTFBS and FLSTN and '09-later Touring models (except Road Glide®). '12-'16 FLD, '04-'17 Softail® models equipped with Freight Train Headlamp Nacelle Kit and '09-'13 Touring models require separate purchase of Headlamp Mounting Ring P/N 67700439 and Jumper Harness P/N 69201070.

67700426	Chrome.	\$849.95
67700427	Black.	\$849.95

B. 7" DAYMAKER PROJECTOR LED HEADLAMP

The 7" Daymaker LED headlamp features a single top-mount low-beam projector lens, a large bottom-mount high-beam projector lens and 2 D-shaped fill-light lenses. The LED lamps include a subtle rear-lit Bar & Shield logo that glows when the ignition is in the accessory switch position. The LED lamps are DOT and ECE compliant for all markets.

Fits '12-'16 FLD, '04-'17 FLS, FLSS, FLSTC, FLSTF, FLSTFB, FLSTFBS and FLSTN and '09-later Touring models (except Road Glide). '12-'16 FLD, '04-'17 Softail models equipped with Freight Train Headlamp Nacelle Kit and '09-'13 Touring models require separate purchase of Headlamp Mounting Ring P/N 67700439 and Jumper Harness P/N 69201070.

67700433	Chrome.	\$574.95
67700430	Black.	\$574.95

Also available:

MOUNTING RING – GLOSS BLACK

67700487	\$24.99
-----------------	----------------

Fits '04-later Softail models equipped with 7" Daymaker LED Headlamps.



A. 7" DAYMAKER ADAPTIVE LED HEADLAMP – BLACK



A. 7" DAYMAKER ADAPTIVE LED HEADLAMP – CHROME



B. 7" DAYMAKER PROJECTOR LED HEADLAMP – BLACK



B. 7" DAYMAKER PROJECTOR LED HEADLAMP – CHROME

Notice: The prices appearing in this catalog are the manufacturer's suggested retail prices. Actual retail prices may vary.

LIGHTING 715

Headlamps – LED



C. 5-3/4" DAYMAKER PROJECTOR LED HEADLAMP



C. 5-3/4" DAYMAKER® PROJECTOR LED HEADLAMP

Lamps feature 2 D-shaped optical lenses, single low-beam lens and three high-beam lenses. The low-beam pattern remains on at all times and the switched high beam adds additional punch down the middle of the road. The LED lamps are DOT and ECE compliant.

Fits '06-'11 VRSCD and VRSCDX, '15-later XG, '04-later XL, '09-'13 XR, '91-'17 Dyna® (except FLD and '91-'05 FXDWG), '84-'99 FLSTS and FXSTS, '08-'11 FLSTSB, '05-'06 FLSTSC, '10-'12 FLSTSE, '00-'17 FXCW, FXCWC, FXS, FXSB, FXSBSE, FXST, FXSTB, FXSTC and FXSTD models. Some models require Vibration Damper P/N 67700059 or Housing Kit P/N 67700093B.

67700144A	Chrome.	\$399.95
67700145A	Black.	\$399.95

Also available:

HEADLAMP VIBRATION DAMPER

Required for mounting the LED headlight in certain models. This damper adds rigidity to the headlamp housing.

67700059 **\$7.95**

Required on '00-'03 FLSTS, '05-'07 FLSTSC, '07-'10 FXSTC, '00-'07 FXSTD and '00-'06 FXSTS models equipped with LED Headlamp.

Also available:

5-3/4" LED HEADLAMP HOUSING KIT

Required for installation of 5-3/4" LED Headlamp on specified models.

67700093B **\$69.95**

Required on '10-later XL1200X, '18-later XL1200XS and '06-'17 Dyna models (except FXDL, FXDLS and FXDWG) equipped with 5-3/4" LED headlamps. FXDF models require separate purchase of Mounting Block P/N 67741-06.



C. 5-3/4" DAYMAKER PROJECTOR LED HEADLAMP – CHROME



C. 5-3/4" DAYMAKER PROJECTOR LED HEADLAMP – BLACK



C. 5-3/4" DAYMAKER PROJECTOR LED HEADLAMP – CHROME



C. 5-3/4" DAYMAKER PROJECTOR LED HEADLAMP – BLACK



Model Family Fitment:

- V-ROD
- SPORTSTER
- DYNA
- SOFTAIL
- TOURING

Notice: The prices appearing in this catalog are the manufacturer's suggested retail prices. Actual retail prices may vary.

LIGHTING

716 LIGHTING

Headlamps – LED

A. DAYMAKER® PROJECTOR LED LAMPS – FAT BOB®

Fat Bob® Daymaker® LED Headlamp Kit features separate left and right lamps that fit easily in the Fat Bob model's unique dual headlamp housing. Each lamp features a single top-mount low-beam projector lens, a matching bottom-mount high-beam projector lens and 2 D-shaped fill-light lenses. The LED lamps are DOT compliant for use in all 50 states.

Fits '08-'17 FXDF models. Does not fit International models.

67700260	Chrome.	\$799.95
67700261	Black.	\$799.95

B. ROAD GLIDE® DAYMAKER PROJECTOR LED HEADLAMP

Road Glide® lamps feature dual headlamp housings mounted to a common back plate for easy installation. Each lamp features a single low-beam projector lens, 3 high-beam projector lenses and 2 D-shaped fill-light lenses. The low-beam pattern remains illuminated at all times and the switched high-beam adds additional light down the center of the lane. The LED lamps are DOT and ECE compliant.

Fits '04-'13 Road Glide models.

67700109	Chrome.	\$749.95
67700112	Contrast Chrome & Black.	\$749.95



A. DAYMAKER PROJECTOR LED LAMPS – FAT BOB, CHROME



A. DAYMAKER PROJECTOR LED LAMPS – FAT BOB, BLACK



B. ROAD GLIDE DAYMAKER PROJECTOR LED HEADLAMP – CHROME



B. ROAD GLIDE DAYMAKER PROJECTOR LED HEADLAMP – CONTRAST CHROME & BLACK

Model Family Fitment:

- V-ROD
- SPORTSTER
- DYNA
- SOFTAIL
- TOURING

Notice: The prices appearing in this catalog are the manufacturer's suggested retail prices. Actual retail prices may vary.



**C. 7" DAYMAKER SIGNATURE REFLECTOR LED HEADLAMP – BLACK
(SHOWN WITH 4" DAYMAKER SIGNATURE REFLECTOR LED AUXILIARY LAMPS)**



**C. 7" DAYMAKER SIGNATURE REFLECTOR LED HEADLAMP – CHROME
(SHOWN WITH 4" DAYMAKER SIGNATURE REFLECTOR LED AUXILIARY LAMPS)**



C. 7" DAYMAKER SIGNATURE REFLECTOR LED HEADLAMP – CHROME



C. 7" DAYMAKER SIGNATURE REFLECTOR LED HEADLAMP – BLACK



C. 5-3/4" DAYMAKER SIGNATURE REFLECTOR LED HEADLAMP – CHROME



C. 5-3/4" DAYMAKER SIGNATURE REFLECTOR LED HEADLAMP – BLACK

C. DAYMAKER® SIGNATURE REFLECTOR LED HEADLAMP

Surrounded by a glowing halo of light, these Daymaker® Signature Reflector LED Lamps offer superior nighttime performance while making a bold visual statement. These brilliant LED lamps produce a bright-white beam that lights up the surroundings and draws the attention of oncoming traffic. The natural daylight lamp color is easy on your eyes and is tuned to enhance and amplify the reflective character of highway signs and lane markers. The efficient LED elements are hidden behind the lamp's stylish center crossbar, and project their brilliant light onto the optically-tuned reflector bowls for a focused beam of light. The always-on low-beam produces a wide pool of general lighting, and the high-beam adds focused light to add punch down the middle of the lane. The long-life solid-state LED lamps are housed in weather-sealed shock and vibration-resistant lamp assemblies. Installation is simple, and the plug-in lamps require no splicing. Meets DOT and ECE standards.

Fits '12-'16 FLD, '91-later Softail®, '94-later Touring (except Road Glide®), and '09-later Trike models. '12-'16 FLD, '94-'13 Touring, '09-'13 Trike, and '94-'17 Softail models equipped with Freight Train Headlamp Nacelle Kit require separate purchase of Headlamp Mounting Ring Kit P/N 67700439. '17-earlier Dyna®, Softail, and Road King® models require separate purchase of Jumper Harness P/N 69201070.

67700353	7" Chrome.	\$499.95
67700354	7" Black.	\$499.95

Fits '15-later XG500, XG750, '17-later XG750A, '11-later XL1200C, '10-later XL1200X, '18-later XL1200XS, '06-'17 FXDB, '16-'17 FXDLS, and '10-'17 FXDWG and '18-later FXBB and FXLR models. All models (except XG500, XG750, and XG750A) require separate purchase of Headlamp Bucket Kit P/N 67700455. XL1200C models require separate purchase of Mounting Block P/N 67746-11.

67700355	5-3/4" Chrome.	\$399.95
67700356	5-3/4" Black.	\$399.95

4" DAYMAKER SIGNATURE REFLECTOR LED AUXILIARY LAMPS

These auxiliary lamps feature reflector bowls that are shaped to add an enhanced pool of light in front of and to the sides of the motorcycle. The LED lamps produce a bright white beam of light, and the modern smooth lens and center-bar reflector design complements the matching Daymaker Signature LED headlamp for a unified look. Meets DOT and ECE standards.

Fits models with 4" round auxiliary forward lighting. '04-earlier models with auxiliary lamps equipped with spade connectors require separate purchase of Adapter Harness P/N 68355-05 (Qty 2).

68000252	Chrome – Pair.	\$359.95
68000253	Black – Pair.	\$359.95

Also available:

7" HEADLAMP MOUNTING RING KIT

Required for installation of accessory 7" LED Headlamps on specific models.

67700439		\$29.95
-----------------	--	----------------

Fits '12-'16 FLD, '94-'13 Touring (except Road Glide) and '09-'13 Trike models. Also fits '94-'17 Softail models equipped with Freight Train Headlamp Nacelle Kit.

Also available:

5-3/4" LED HEADLAMP HOUSING KIT

Required for installation of 5-3/4" Daymaker Signature LED Headlamp P/N 67700355 or 67700356 on specific models. Kit includes headlamp bucket, mounting blocks and necessary hardware.

67700455		\$149.95
-----------------	--	-----------------

Fits '10-later XL1200C, '10-later XL1200X, '18-later XL1200XS, '06-'17 FXDB, '16-'17 FXDLS, '10-'17 FXDWG and '13-'17 FXSB models.

Notice: The prices appearing in this catalog are the manufacturer's suggested retail prices. Actual retail prices may vary.

718 LIGHTING

Headlamps – Auxiliary

A. DAYMAKER® REFLECTOR LED FOG LAMPS

Compact 2.5" bullet-shaped reflector-optics fog lamps produce a bright white pool of light near the vehicle and fill in the dark area between the bike and the low-beam pattern. The fog lamps project a smooth light pattern spread without distracting hot spots and the natural daylight lamp color enhances and amplifies the reflective character of lane markers. Unlike some traditional fog lamps, the low-draw LED lamps do not burden the bike's electrical system. The long-life solid-state LED lamps are sealed in shock and vibration-resistant housings that mount to the engine guard or the Road Glide® fairing for a clean appearance. Fog lamps are DOT and ECE compliant.

Fits Dyna®, Softail®, Touring and Trike models equipped with 1.25" diameter Engine Guards. Also fits '15-later Road Glide models with separate purchase of fairing mount Road Glide LED Fog Lamp Mount Kit P/N P/N 68000183 or 68000184. Does not fit models with Mustache Engine Guards. Installation requires separate purchase of model-specific Clamp Kit and Wiring Harness Kit.

68000090	Chrome Housing.	\$399.95
68000092	Gloss Black Housing.	\$399.95

Also available:

LED FOG LAMP WIRING HARNESS

Required for installation of LED Fog Lamp P/N 68000090 or 68000092 on specific models.

69200863	\$29.95
Fits Dyna and Softail models. Kit includes universal handlebar-mounted switch.	

69201108	\$29.95
Fits '97-later Road King® (except FLHRS) and '15-later Freewheeler® models. Kit uses Original Equipment nacelle switch to power the fog lamps for Road King. Freewheeler requires separate purchase of P/N 71522-08.	

69201109	\$29.95
Fits '14-later Electra Glide®, Road Glide, Street Glide® and Tri Glide® models. Street Glide and Road Glide Custom models require separate purchase of Switch Pack P/N 69200172. Not required for fairing mount Road Glide LED Fog lamp mount kits, P/N 68000183 and 68000184.	

69200864	\$29.95
Fits '97-'13 Electra Glide, Road Glide, Street Glide and Trike models. Models without an Original Equipment fog lamp switch require separate purchase of Switch Kit P/N 71505-96.	

B. LED FOG LAMP ENGINE GUARD CLAMP KIT

Required for installation of LED Fog Lamp P/N 68000090 or 68000092 on specific models. Kit includes left and right clamp and all required mounting hardware. Lamps and wiring harnesses sold separately.

Fits Touring and Trike models equipped with 1.25" Engine Guards and fairing lowers.

68000170	Chrome.	\$54.95
68000142	Gloss Black.	\$54.95

Fits Dyna, Softail, Touring, and Trike models equipped with 1.25" engine guards. Does not fit models with Mustache Engine Guards. Does not fit models equipped with Original Equipment or accessory fairing lowers.

68000171	Chrome.	\$54.95
68000141	Gloss Black.	\$54.95



A. DAYMAKER REFLECTOR LED FOG LAMPS



A. DAYMAKER REFLECTOR LED FOG LAMPS – CHROME HOUSING



A. DAYMAKER REFLECTOR LED FOG LAMPS – GLOSS BLACK HOUSING



A. DAYMAKER REFLECTOR LED FOG LAMPS – CHROME & GLOSS BLACK



B. LED FOG LAMP ENGINE GUARD CLAMP KITS – CHROME & GLOSS BLACK

Notice: The prices appearing in this catalog are the manufacturer's suggested retail prices. Actual retail prices may vary.



C. ROAD GLIDE LED FOG LAMP MOUNT KIT – CHROME



C. ROAD GLIDE LED FOG LAMP MOUNT KIT – CHROME



C. ROAD GLIDE LED FOG LAMP MOUNT KIT – GLOSS BLACK



C. ROAD GLIDE LED FOG LAMP MOUNT KIT – CHROME & GLOSS BLACK



D. PERFORMANCE HEADLAMP BULB

C. ROAD GLIDE® LED FOG LAMP MOUNT KIT

This elegant Mount Kit replaces the Original Equipment turn signal mount, and positions the Daymaker® Reflector LED Fog Lamps and turn signals close to the fairing for a custom look. The resulting installation provides a supplemental pool of light in front of the motorcycle, and a clean, uncluttered look to your bike's profile. Mount can be used with Original Equipment or accessory Bullet Turn Signals. Available in chrome or gloss black finish, the kit includes left and right mounts and all required hardware. Requires separate purchase of Daymaker Reflector LED Fog Lamps.

Fits '15-later Road Glide® models with Original Equipment or accessory bullet turn signals. Requires separate purchase of Daymaker Reflector LED Fog Lamps. May require purchase of Original Equipment switch pack, see dealer for details.

68000183	Chrome.	\$99.95
68000184	Gloss Black.	\$99.95

D. PERFORMANCE HEADLAMP BULB

This Xenon gas-filled replacement headlamp bulb lights the way with a whiter, more natural light. The coating on the lamp shows a slight blue tint to the oncoming traffic.

67074-02 **\$29.95**

Fits all models with replaceable headlamp bulb (except '02-later VRSCA, '04 VRSCB, '06-later VRSCR, VRSCX, VRSCF, '15-later XG, '08-'12 XR and models equipped with Dual Bulb Halogen Headlamp Kit P/N 67864-04 or 67863-04).

Model Family Fitment:

- V-ROD
- SPORTSTER
- DYNA
- SOFTAIL
- TOURING

Notice: The prices appearing in this catalog are the manufacturer's suggested retail prices. Actual retail prices may vary.

720 LIGHTING

Headlamps – Auxiliary

A. AUXILIARY LIGHTING KIT

There's a lot of road on this planet and these chrome lamps will light the way. Just add the desired lamp bulb kit (sold separately) to complete the installation. The kit includes the chrome lamp housings and the chrome mounting brackets that match the contour of the triple tree and highlight the headlamp. Kit comes complete with the necessary wiring, switch and hardware for installation. Can be used with Turn Signal Relocation Kit P/N 68603-01 (Bulbs sold separately.)

68000110 **\$299.95**

Fits '14-later XL models (except XL1200CX, XL1200T, XL1200X and XL1200XS).

68605-08A **\$319.95**

Fits '06-'17 Dyna® models (except FLD).

69284-05 **\$309.95**

Fits '88-'13 XL, '88-'94 FXR, FXRS and FXLR (except models equipped with engine guards or Front Directional Signal Relocation Kit P/N 68517-94A) and '91-'05 Dyna models (except FXDS-CONV, FXDWG and FXDXT). '88-'97 XL883, '88-'96 XL883 Deluxe, '96-'97 XL1200S, '88-'94 FXRS-SP and '91-'92 FXDB-S require Turn Signal Relocation Kit P/N 68603-01.

Also available:

TURN SIGNAL RELOCATION KIT

This kit relocates the turn signals to the passing lamp bracket and allows the use of a detachable windshield. Kit includes all necessary hardware required for installation.

68603-01 **\$49.95**

Fits '88-later XL (except XL1200CX, XL1200T, XL1200X and XL1200XS), '91-'05 Dyna and '84-'15 FXS, FXST, FXSTB and FXSTC models equipped with Auxiliary Lighting Kits.

Also available:

WINDSHIELD DOCKING HARDWARE AND TURN SIGNAL RELOCATION KIT

Required for installation of H-D® Detachables™ Windshields on FXDWG and FXST models equipped with Passing Lamps. Includes windshield mounting hardware and turn signal relocation hardware.

58361-03 **\$99.95**

Fits '93-'05 FXDWG and '84-'15 FXST, FXSTB and FXSTC models equipped with Auxiliary Lighting Kits.



A. AUXILIARY LIGHTING KIT – 68000110 SHOWN
(SHOWN WITH TURN SIGNAL RELOCATION KIT AND AUXILIARY LAMP BULB KIT)



A. AUXILIARY LIGHTING KIT – 68605-08A SHOWN
(SHOWN WITH AUXILIARY LAMP BULB KIT)



A. AUXILIARY LIGHTING KIT –
69284-05 SHOWN
(SHOWN WITH AUXILIARY LAMP BULB KIT)

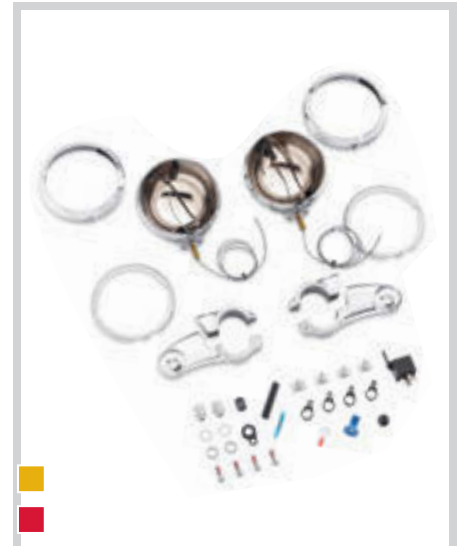

A. AUXILIARY LIGHTING KIT
(69284-05 SHOWN)

Notice: The prices appearing in this catalog are the manufacturer's suggested retail prices. Actual retail prices may vary.



**B. CUSTOM AUXILIARY LIGHTING KIT
(SHOWN WITH AUXILIARY LAMP BULB KIT)**

B. CUSTOM AUXILIARY LIGHTING KIT

Shaped by the wind, this Auxiliary Lighting Kit follows the contours of the triple tree and headlamp shell for a custom look. The chrome-plated cantilever brackets serve as stylized mounting points for the passing lamp housings and eliminate the cross brace and flat side supports of traditional auxiliary lamps. The brackets can also accommodate the bike's Original Equipment bullet turn signals if you choose to relocate them from the handlebar for a clean look. Kit includes die-cast aluminum brackets, lamp housings and all required wiring and hardware. All you need to add is your choice of bulb style and you'll light up the open road. Bulbs sold separately.

68000051 **\$309.95**
Fits '12-'16 FLD and '00-'17 FLS, FLSS, FLSTF, FLSTFB and FLSTFB models. Softail® models require the separate purchase of Mounting Kit P/N 68000069.

Also available:

CUSTOM AUXILIARY LIGHTING MOUNTING KIT – FAT BOY® MODELS

Required for installation of Custom Auxiliary Lighting Kit P/N 68000051 on Fat Boy® and Softail Slim® models. Kit includes fasteners, wiring and windshield mounting hardware.

68000069 **\$69.95**
Required for installation of Custom Auxiliary Lighting Kit P/N 68000051 on Fat Boy and Softail Slim models.

C. AUXILIARY LIGHTING KIT – FL SOFTAIL® MODELS

Function and style in one. This Auxiliary Lighting Kit features traditional mounting brackets and a tubular crossbar contoured to accent the headlamp. Available in bright chrome or gloss black finish, the kit includes lamp housings and all required wiring, toggle switch and hardware. All you need to add is your choice of bulb style and you'll light up the open road. (Bulbs sold separately.)

Fits '00-'17 FLS, FLSS, FLSTF, FLSTFB and FLSTFBS and '06 FLST models.

69287-07	Chrome.	\$239.95
68000026	Gloss Black.	\$219.95

Shown with:

TURN SIGNAL RELOCATION KIT FOR AUXILIARY LIGHTING KITS

Easy to install, this kit relocates the turn signals from the handlebar to the auxiliary lamp chrome mounting bracket. Provides a clean look to the front end of the motorcycle by removing wires and lights from the handlebar area. Kit includes turn signals for auxiliary lamps, mounting bracket and all necessary hardware.

Fits Softail models equipped with Auxiliary Lighting Kit P/N 69287-07 or 68000026.

68413-99A	Domestic.	\$119.95
68412-99A	International.	\$119.95



**C. AUXILIARY LIGHTING KIT – FL SOFTAIL MODELS, CHROME
(SHOWN WITH AUXILIARY LAMP BULB KIT AND TURN SIGNAL RELOCATION KIT)**



**C. AUXILIARY LIGHTING KIT – FL SOFTAIL MODELS, GLOSS BLACK
(SHOWN WITH AUXILIARY LAMP BULB KIT)**

Model Family Fitment:

- | | | |
|--|--|---|
| V-ROD | SPORTSTER | DYNA |
| SOFTAIL | TOURING | |

Notice: The prices appearing in this catalog are the manufacturer's suggested retail prices. Actual retail prices may vary.

722 LIGHTING

Headlamps – Auxiliary

A. DELUXE AUXILIARY LIGHTING KIT – FL SOFTAIL® MODELS

Shaped by the wind. These billet-look mounting brackets hug the contour of the smooth chrome Triple Tree Cover (included). Separate purchase of the sealed lamp is required to allow the flexibility to choose from four different styles. Bulbs sold separately.

Fits '00-'17 FLS, FLSS, FLSTF, FLSTFB and FLSTFBS and '06 FLST models. Compatible with Nostalgic Windshield Kit P/N 57140-05, 57181-05 and 57141-05 only. Will not fit with Chrome Headlamp Nacelle Kit P/N 67907-96B.

68669-05A	Domestic.	\$409.95
68670-05A	International.	\$409.95

B. AUXILIARY LAMP BULB KITS

Available in 3 lens styles, these sealed beam bulbs are a direct replacement for Original Equipment or accessory Auxiliary Lighting Kits.

Fits all models with Original Equipment or accessory Auxiliary Lighting Kits (except '14-later Electra Glide®, Street Glide®, Ultra Limited and Trike models). Sold in pairs.

1. Clear Lens with Halogen Bulb	
68208-98A	\$74.95
2. Clear Lens and Vertical Reflector Optics	
68348-05	\$74.95

C. INDEPENDENT CONTROL AUXILIARY LAMP WIRE HARNESS KIT

Maximize your nighttime view down a lonely stretch of back road. This simple-to-install wiring harness permits independent control of your bike's auxiliary lamps and allows the lamps to be switched on when the headlamp is in either the low or high beam setting.

69200441 **\$29.95**
Fits '98-'13 Electra Glide, Street Glide and Trike models equipped with auxiliary lamps.

69200442 **\$29.95**
Fits '96-'17 FL Softail® and '97-'13 Road King® models equipped with auxiliary lamps.



A. DELUXE AUXILIARY LIGHTING KIT – FL SOFTAIL MODELS (SHOWN WITH AUXILIARY LAMP BULB KIT)



B. AUXILIARY LAMP BULB KITS



C. INDEPENDENT CONTROL AUXILIARY LAMP WIRE HARNESS KIT (TOURING SHOWN)

Model Family Fitment:

 V-ROD	 SPORTSTER	 DYNA
 SOFTAIL	 TOURING	

Notice: The prices appearing in this catalog are the manufacturer's suggested retail prices. Actual retail prices may vary.



D. CUSTOM AUXILIARY LIGHTING KIT – CHROME
(67800367 SHOWN)

D. CUSTOM AUXILIARY LIGHTING KIT

Shaped by the wind, this Auxiliary Lighting Kit follows the contours of the triple tree and headlamp shell for a custom look. The elegant cantilever brackets serve as stylized mounting points for the passing lamp and turn signal housings and eliminate the cross brace and flat side supports of traditional auxiliary lamps.

Fits '14-later FLHX and FLHXS models. Kit includes passing lamp housings, retaining rings, mounting brackets, bullet turn signals, auxiliary lamp switch and hardware. Auxiliary Lamp Bulbs sold separately.

67800367	Chrome.	\$429.95
67800366A	Gloss Black.	\$429.95

Fits '06-'13 FLHX and '10-'11 FLHXXX models. Kit includes passing lamp housings, retaining rings, mounting brackets, auxiliary lamp switch and hardware. Auxiliary Lamp Bulbs and Bullet Turn Signal Kits sold separately.

69818-06	Chrome.	\$369.95
68000042	Gloss Black.	\$369.95

Fits '97-'13 Electra Glide® and '94-'13 Road King® models. Does not fit Street Glide® models. Road King models equipped with windshield require separate purchase of Hardware Kit P/N 69235-04. CVO™ Road King models require the purchase of additional components. For installation on FLHRS models that do not presently have a windshield, but wish to install a windshield, the additional purchase of Hardware Kit P/N 69234-04 is required. Kit includes passing lamp housings, mounting brackets and hardware. Installation reuses Original Equipment sealed beam lamps and retaining rings. Bullet Turn Signal Kits sold separately.

69227-04A	Chrome.	\$349.95
68000043	Gloss Black.	\$349.95

Also available:

CUSTOM AUXILIARY LAMP BRACKET TURN SIGNAL KIT

Add your choice of Bullet Style Turn Signals to the Custom Passing Lamp Bracket. Select from amber, clear or smoked lens turn signal kits to complement your custom direction. Kit includes left and right bullet turn signal housing, two lenses and two front bulbs.

Fits '94-'13 FLHR and '97-'13 FLHT and FLHX models equipped with Custom Auxiliary Lighting Bracket Kits.

69230-04	Chrome Amber Lens, Clear Bulb.	\$69.95
69228-04	Chrome Smoked Lens, Amber Bulb.	\$69.95
67800166	Black Smoked Lens, Amber Bulb.	\$74.95

Also available:

CUSTOM AUXILIARY LAMP BRACKET HARDWARE KIT

Add Custom Passing Lamp Brackets to your Road King model.

69235-04		\$9.95
-----------------	--	---------------

Required to install the Custom Auxiliary Lighting Bracket Kit P/N 69227-04A on '94-'13 Road King models equipped with a H-D® Detachables™.

69234-04		\$16.95
-----------------	--	----------------

Required to install the Custom Auxiliary Lighting Bracket Kit P/N 69227-04A on FLHRS models not presently equipped with a windshield, but wish to install a windshield at the same time or in the future.



D. CUSTOM AUXILIARY LIGHTING KIT – CHROME



D. '97-'13 MODELS



D. '14-LATER MODELS



D. CUSTOM AUXILIARY LIGHTING KIT – GLOSS BLACK



D. '97-'13 MODELS



D. '14-LATER MODELS

Notice: The prices appearing in this catalog are the manufacturer's suggested retail prices. Actual retail prices may vary.

724 LIGHTING

Headlamps – Shells

A. BILLET HEADLAMP SHELL

Add style and substance to the front fork with this bullet-shaped Headlamp Shell. Manufactured from billet aluminum, this extended headlamp housing recesses the headlamp for a true custom appearance. The mirror-finish chrome surfaces and the close-fitting inner trim ring create the appearance of a one-piece design. Kit includes chrome-plated mounting hardware and a custom billet mount.

67704-03 **\$339.95**

Fits '99-'05 FXDWG and '00-'17 FXS, FXSB, FXSBSE, FXST, FXSTB, FXSTC and FXSTD models. Also fits '02-'11 VRSC™ models (except VRSCF) equipped with Installation Bracket P/N 68211-05. Not compatible with LED headlamps. (Does not fit International models.)

B. BULLET HEADLAMP KIT

Light the way to a custom look. This mirror chrome Bullet Headlamp Kit features a high-tech deep drawn aluminum housing that is precision machined for a perfect contour and surface finish. The visor-style shell adds a unique profile to the bike's front end and the complete kit includes a smooth lens lamp assembly with a replaceable halogen bulb.

68593-06 5-3/4" **\$349.95**

Fits '06-'17 FXD, FXD35, FXDB, FXDC, FXDF and FXDSE, '06-'13 FXDL, '94-'17 FXDWG, '99-'00 FXR, '98-later XL883C, '96-'10 and '14-later XL1200C, '14-'16 XL1200V, '08-'17 FXCW, FXCWC, FXS, FXSB and FXSBSE, '99-'15 FXST and FXSTB, '86-'10 FXSTC and '00-'07 FXSTD models. Installation requires separate purchase of appropriate Headlamp Mounting System P/N 68595-06 or 69611-06. Not compatible with LED headlamps.

Shown with:

HEADLAMP MOUNTING SYSTEM FOR BULLET HEADLAMP

Chrome-plated headlamp mounts are designed to position the Bullet Headlamp Kit in the proper location for specific vehicle applications. The mount is machined from solid steel for performance and durability and is polished and plated for a superior custom look.

68595-06 Short Mount. **\$44.95**

Fits '94-'05 FXDWG, '08-'17 FXCW, FXCWC, FXS, FXSB and FXSBSE, '99-'15 FXST and FXSTB, '86-'10 FXSTC and '00-'07 FXSTD models.

69611-06 Tall Mount. **\$49.95**

Fits '98-later XL883C, '96-'10 and '14-later XL1200C, '14-'16 XL1200V, '99-'00 FXR, '06-'10 FXD, '06 FXD35, '06-later FXDB, FXDF and FXDWG, '06-'14 FXDC and '07-'08 FXDSE models. Also fits '00-'17 FX Softail® models equipped with Custom Inverted Front Fork Kit.

C. DUAL HEADLAMP KIT

First introduced on the Fat Bob® model, this unique Dual Headlamp housing adds a slimmed-down custom look to the Wide Glide® model's stretched front end. Complete kit includes headlamp housing, headlamp bulbs and mounting hardware.

69797-08 Domestic. **\$359.95**
Fits '06-'17 FXDWG models.

69802-08 International. **\$359.95**
Fits '06-'08 FXDWG models.



A. BILLET HEADLAMP SHELL



B. BULLET HEADLAMP AND MOUNTING KIT – 5-3/4"



C. DUAL HEADLAMP KIT

Notice: The prices appearing in this catalog are the manufacturer's suggested retail prices. Actual retail prices may vary.

LIGHTING 725

Headlamp Trim

D. DEFIANCE COLLECTION HEADLAMP TRIM RING

Ringed with deep radial grooves, Defiance Collection Headlamp Trim Rings reflect your custom taste. Available in mirror chrome, gloss black or machine cut black finishes, these cast aluminum trim rings surround the leading edge of the lamp for a solid billet look. Easy to install rings include mounting hardware.

Fits '14-later Electra Glide®, Street Glide®, Ultra Limited and Tri Glide® models and '94-later Road King® models.

61400347	7" – Chrome.	\$159.95
61400349	7" – Black Machine Cut.	\$174.95
61400348	7" – Black Anodized.	\$159.95

Fits '18-later FLDE, FLHC, FLHCS, FL5B and FL5L models.

61400432	7" – Chrome.	\$159.95
61400433	7" – Black Machine Cut.	\$174.95
61400434	7" – Black Anodized.	\$159.95

Fits '18-later FXBB and FXLR models.

61400429	5-3/4" – Chrome.	\$139.95
61400430	5-3/4" – Black Machine Cut.	\$154.95
61400431	5-3/4" – Black Anodized.	\$139.95

Fits '62-later models equipped with Original Equipment or accessory Auxiliary Lamp Kits. Sold in pairs.

61400353	4" Auxiliary Lamp – Chrome.	\$199.95
61400355	4" Auxiliary Lamp – Black Machine Cut.	\$219.95
61400354	4" Auxiliary Lamp – Black Anodized.	\$199.95



D. DEFIANCE COLLECTION HEADLAMP TRIM RING – 7" CHROME



D. DEFIANCE COLLECTION HEADLAMP TRIM RING – 7" BLACK ANODIZED



D. DEFIANCE COLLECTION HEADLAMP TRIM RING – 7" BLACK MACHINE CUT



D. DEFIANCE COLLECTION HEADLAMP TRIM RING – 7" BLACK ANODIZED



D. DEFIANCE COLLECTION HEADLAMP TRIM RING – 5-3/4" CHROME



D. DEFIANCE COLLECTION HEADLAMP TRIM RING – 5-3/4" BLACK MACHINE CUT



D. DEFIANCE COLLECTION AUXILIARY LAMP TRIM RING – 4" CHROME



D. DEFIANCE COLLECTION AUXILIARY LAMP TRIM RING – 4" BLACK MACHINE CUT

Model Family Fitment:

- V-ROD
- SPORTSTER
- DYNA
- SOFTAIL
- TOURING

Notice: The prices appearing in this catalog are the manufacturer's suggested retail prices. Actual retail prices may vary.

726 LIGHTING

Headlamp Trim

A. FRENCHED TRIM RING COLLECTION

This chrome-plated Headlamp Trim Ring extends forward, giving the headlamp assembly a frenched look reminiscent of classic hot rod car designs by recessing the headlamp and adding the appearance of depth. Functions as a direct replacement for the Original Equipment trim ring, except when used with P/N 69627-99, where it easily installs over the Original Equipment trim ring. (Does not fit with Accessory Headlamp Visor or Passing Lamp Visor.)

1. 69627-99 Headlamp. **\$43.95**
Fits '12-'16 FLD, '94-later Road King®, '83-'13 Touring (except Tour Glide™ and Road Glide®) and '08-'13 Trike models. Also Fits '86-'17 FL Softail® models with Freight Train Headlight Nacelle. (Does not fit with Fairing Bra P/N 57800-00.)

2. 69622-99B Passing Lamp. **\$59.95**
Fits '62-later models equipped with Original Equipment or accessory Auxiliary Lamp Kits. Sold in pairs.

3. 69740-01 Turn Signal – Flat Lens. **\$46.95**
Fits flat lens turn signals on rear of '06 FLST, '94-'17 FLSTC, '94-'97 FLSTN and on the front and rear of '14-later FLHR, FLHRC and '88-'13 Touring (except FLHRS, FLHX and '04-'13 FLTR) models. Also fits FL Softail models with front Turn Signal Relocation Kit P/N 68413-99 or 68412-99.

67700215 Headlamp. **\$44.95**
Fits '94-later Road King, '14-later Electra Glide®, Street Glide®, Ultra Limited and Tri Glide® models.

69626-99 Headlamp. **\$43.95**
Fits '94-'17 FLS, FLSS, FLSTF, FLSTFB, FLSTFBS and FLSTN and '15-later FLRT models.

69623-99A Headlamp. **\$37.95**
Fits '05 VRSCB, '04-later XL883, XL883L, XL883N, XL883R, XL1200L, XL1200N, XL1200R, XL1200T, XL1200X and XL1200XS, '16-later XL1200CX, '94-'17 Dyna® (except FXDF and FLD equipped with 7" headlamp), '94-'15 FXLR, FXST and FXSTB, '08-'17 FLSTSB and FXS, '16-'17 FXSE and '94-'99 FXSTC models.

69624-99A Headlamp. **\$37.95**
Fits '96-later XL883C, XL1200C and XL1200V, '16-later XL1200CX, '99 FXR, '16-'17 FXDLS, '97-'03 FLSTS, '05-'07 FLSTSC, '16-'17 FXSE, '07-'10 FXSTC, '00-'07 FXSTD, '93-'06 FXSTS and '95-'97 FXSTSB models.



**A. FRENCHED TRIM RING COLLECTION
(HEADLAMP, PASSING LAMP AND TURN SIGNAL TRIM RINGS) – ROAD KING**



A. FRENCHED TRIM RING – ELECTRA GLIDE



A. FRENCHED TRIM RING – SOFTAIL STANDARD



A. FRENCHED TRIM RING – DYNA LOW RIDER



A. FRENCHED TRIM RING – XL883 LOW

Notice: The prices appearing in this catalog are the manufacturer's suggested retail prices. Actual retail prices may vary.



**B. VISOR STYLE TRIM RING COLLECTION
(HEADLAMP, PASSING LAMP AND TURN SIGNAL TRIM RINGS) – ROAD KING**

B. VISOR STYLE TRIM RING COLLECTION

These chrome-plated Visor Style Trim Rings recess the headlamp into the housing and add a traditional eyebrow design to the headlamp shell. The trim ring stretches the profile of the bike for a long, lean appearance. Add matching Visor Style Passing Lamp and Turn Signal Trim Rings for a true custom look.

1. 69733-05 Headlamp. **\$43.95**
Fits '12-'16 FLD, '94-later Road King®, '83-'13 Touring (except Tour Glide™ and Road Glide®) and '08-'13 Trike models. Also fits '86-'17 FL Softail® models with Freight Train Headlight Nacelle. (Does not fit with Fairing Bra P/N 57800-00.)

2. 69732-05 Passing Lamp. **\$59.95**
Fits '62-later models equipped with Original Equipment or accessory Auxiliary Lamp Kits. Sold in pairs.

3. 69749-05 Turn Signal – Flat Lens. **\$46.95**
Fits flat lens turn signals on rear of '06 FLST, '94-'17 FLSTC, '94-'97 FLSTN and on the front and rear of '14-later FLHR, FLHRC and '88-'13 Touring (except FLHRS, FLHX and '04-'13 FLTR) models. Also fits FL Softail models with front Turn Signal Relocation Kit P/N 68413-99 or 68412-99.

67700216 Headlamp. **\$44.95**
Fits '94-later Road King, '14-later Electra Glide®, Street Glide®, Ultra Limited and Tri Glide® models.

69734-05 Headlamp. **\$43.95**
Fits '94-'17 FLS, FLSS, FLSTF, FLSTFB, FLSTFBS and FLSTN and '15-later FLRT models.

69735-05 Headlamp. **\$37.95**
Fits '05 VRSCB, '04-later XL883, XL883L, XL883N, XL883R, XL1200L, XL1200N, XL1200R, XL1200T, XL1200X and XL1200XS, '16-later XL1200CX, '94-'17 Dyna® (except FXDF and FLD equipped with 7" headlamp), '94-'15 FXLR, FXST and FXSTB, '08-'17 FLSTSB and FXS, '16-'17 FXSE and '94-'99 FXSTC models.

69738-05 Headlamp. **\$37.95**
Fits '96-later XL883C, XL1200C and XL1200V, '16-later XL1200CX, '18-later XL1200XS, '99 FXR, '97-'03 FLSTS, '05-'07 FLSTSC, '07-'10 FXSTC, '00-'07 FXSTD, '93-'06 FXSTS and '95-'97 FXSTSB models.

LIGHTING



B. VISOR STYLE TRIM RING – ELECTRA GLIDE



B. VISOR STYLE TRIM RING – SOFTAIL DELUXE



B. VISOR STYLE TRIM RING – XL/DYNA



B. VISOR STYLE TRIM RING – XL CUSTOM

Model Family Fitment:

V-ROD
 SPORTSTER
 DYNA
 SOFTAIL
 TOURING

Notice: The prices appearing in this catalog are the manufacturer's suggested retail prices. Actual retail prices may vary.

728 LIGHTING

Headlamp Trim Rings

A. HEADLAMP TRIM RING – BURST COLLECTION

Sculpted machining sends reflections of light in all directions. This Headlamp Trim Ring features a rich black anodized finish that is machined to expose the highlights of raw aluminum. The contrasting cut-back look makes a powerful visual statement and works great with both traditional and contemporary customizing styles. Easy to install.

61400319 **\$139.95**
Fits '14-later Electra Glide®, Street Glide®, Ultra Limited and Tri Glide® models and '94-later Road King® models.

61400149 **\$139.95**
Fits '96-'13 Electra Glide, Street Glide and Trike models (except '11-'13 FLHTCUSE and '11 FLHXSE). Does not fit with Fairing Bra P/N 57800-00. Does not fit with accessory headlamps P/N 67700040A, 67700243 or 90050-02A.

Shown with:

AUXILIARY LAMP TRIM RINGS – BURST COLLECTION

Lamp Trim Rings feature a rich black anodized finish that is machined to expose the highlights of raw aluminum. Easy to install.

61400255 **\$199.95**
Fits '62-later models equipped with Original Equipment or accessory Auxiliary Lamp Kits. Sold in pairs.

B. HEADLAMP TRIM RING – GLOSS BLACK

Finish the Dark Custom look by replacing the Original Equipment chrome headlamp trim ring with sinister black. Easy to install, the ring's rich black surface matches the stock headlamp shell finish for a unified look.

4655-03B 7" Headlamp. **\$39.95**
Fits '94-later Touring (except Road Glide®) and FLHTCUTG models.

61400573 7" Headlamp. **\$39.95**
Fits '18-later FLDE, FLHC, FLHCS, FLFSB and FLSL models.

67700487 7" Headlamp. **\$24.99**
Fits '04-later Softail models equipped with 7" Daymaker LED Headlamps.

61400574 5-3/4" Headlamp. **\$34.95**
Fits '18-later FXBB and FXLR models.

67700115 7" Headlamp. **\$39.95**
Fits '08-'17 FLS, FLSS, FLSTF, FLSTFB, FLSTFBS and FLSTN and '15-later FLRT models.

67700116 5-3/4" Headlamp. **\$34.95**
Fits '05 VRSCB, '06-'08 VRSCD, '07-'11 VRSCDX, '04-later XL883L, XL883N, XL883R, XL1200R, XL1200N, XL1200T, XL1200X and XL1200XS, '04-'11 XL883C, XL1200C, '16-later XL1200CX, '93-'17 Dyna® (except FLD and FXDF) and '11-'13 FXS and '13-'17 FXSB models.

67700117 4" Passing Lamp. **\$49.95**
Fits '62-later models equipped with Original Equipment or accessory Auxiliary Lamp Kits. Sold in pairs.

C. CONTOURED HEADLAMP TRIM RING

Add an integrated look to your headlamp. The Contoured Headlamp Trim Ring, introduced on the Screamin' Eagle® Road King model, is designed to visually reduce the space between the headlamp bulb and the headlamp housing for a sleek, custom style. The bright chrome finish matches the headlamp housing for a factory original look.

69604-03A **\$49.95**
Fits '83-later Touring (except Tour Glide™ and Road Glide). Also fits '86-'17 FL Softail® models with Freight Train Headlight Nacelle. Does not fit Trike models.



A. HEADLAMP TRIM RING – BURST COLLECTION (SHOWN WITH BURST AUXILIARY LAMP TRIM RINGS)



B. HEADLAMP TRIM RING – GLOSS BLACK ('19 SOFTAIL SLIM SHOWN)



B. HEADLAMP TRIM RING – GLOSS BLACK ('19 STREET BOB SHOWN)



B. HEADLAMP TRIM RING – GLOSS BLACK (ROAD KING SHOWN)



B. HEADLAMP TRIM RING – GLOSS BLACK (FAT BOY LO SHOWN)



B. HEADLAMP TRIM RING – GLOSS BLACK (IRON 883 SHOWN)



C. CONTOURED HEADLAMP TRIM RING

Notice: The prices appearing in this catalog are the manufacturer's suggested retail prices. Actual retail prices may vary.

LIGHTING 729

Headlamp Trim Rings



D. FRENCHED TRIM RING COLLECTION – GLOSS BLACK (ELECTRA GLIDE SHOWN)



D. FRENCHED TRIM RING COLLECTION – GLOSS BLACK (ROAD KING SHOWN)



E. VISOR STYLE TRIM RING COLLECTION – GLOSS BLACK (ELECTRA GLIDE SHOWN)



E. VISOR STYLE TRIM RING COLLECTION – GLOSS BLACK (ROAD KING SHOWN)



F. FREIGHT TRAIN HEADLIGHT NACELLE – CHROME



F. FREIGHT TRAIN HEADLIGHT NACELLE – GLOSS BLACK

D. FRENCHED TRIM RING COLLECTION – GLOSS BLACK

This easy to install Headlamp Trim Ring extends forward, giving the headlamp assembly a frenched look reminiscent of classic hot rod car designs by recessing the headlamp and adding the appearance of depth. Does not fit with accessory Headlamp Visors or Passing Lamp Visors.

61400294 7" Headlamp – Gloss Black. **\$49.95**
Fits '94-later Road King®, '14-later Electra Glide®, Street Glide®, Ultra Limited and Tri Glide® models.

61400295 7" Headlamp – Gloss Black. **\$49.95**
Fits '12-'16 FLD, '83-'13 Touring (except Tour Glide™ and Road Glide®), '94-later Road King and '08-'13 Trike models. Also fits '86-'17 FL Softail® models with Freight Train Headlight Nacelle. Does not fit with Fairing Bra P/N 57800-00.

E. VISOR STYLE TRIM RING COLLECTION – GLOSS BLACK

These easy to install Visor Style Trim Rings recess the headlamp into the housing and add a traditional eyebrow design to the headlamp shell. The trim ring stretches the profile of the bike for a long, lean appearance.

61400292 7" Headlamp – Gloss Black. **\$49.95**
Fits '94-later Road King, '14-later Electra Glide, Street Glide, Ultra Limited and Tri Glide models.

61400293 7" Headlamp – Gloss Black. **\$49.95**
Fits '12-'16 FLD, '83-'13 Touring (except Tour Glide™ and Road Glide®), '94-later Road King and '08-'13 Trike models. Also fits '86-'17 FL Softail models with Freight Train Headlight Nacelle. Does not fit with Fairing Bra P/N 57800-00.

F. FREIGHT TRAIN HEADLIGHT NACELLE

If the shape of this nacelle seems to reflect the image of the 1960s FL models, that's because the spirit of the past is built right in. Bold locomotive styling adds visual strength to the bike's profile and stretches the rider's view to the horizon when looking over the headlamp. Coupled with the separate purchase of the Nacelle Hardware Kit P/N 67897-96B, the nacelle fits with an existing H-D® windshield and/or passing lamps. Kit includes hardware required for installation of the nacelle with a detachable windshield without passing lamps. Separate Hardware Kit is required when installing nacelle with passing lamps or rigid mount windshield.

Fits '86-'17 FLST, FLSTF, FLSTFB, FLSTFBS and FLSTC models. '07-'17 FLSTF, FLSTFB and FLSTFBS models with Original Equipment 1.25" handlebar require separate purchase of Riser Kit P/N 56789-05. '09-'17 FLSTC models with Original Equipment 1.0" handlebar requires separate purchase of Riser Kit P/N 46809-09.

61300420 Chrome. **\$449.95**

61300421 Gloss Black. **\$449.95**

Model Family Fitment:

- V-ROD
- SPORTSTER
- DYNA
- SOFTAIL
- TOURING

Notice: The prices appearing in this catalog are the manufacturer's suggested retail prices. Actual retail prices may vary.

730 LIGHTING

Headlamp Trim Rings

A. LAMP VISORS

This complete collection of Lamp Visors dresses your bike for a true custom look.

Headlamp

Fits 7" Headlamp (except '18-later Softail® and FLHTCU, FLHTCUL, FLHTK, FLHTKL FLHTKSE, FLHX, FLHXS, FLHXSE, FLTRU, FLTRX, FLTRXS, FLTRXSE and FLHTCUTG models). (Does not fit with Accessory Headlamp Trim Rings.)

69793-07	Skull.	\$26.95
67752-77T	Classic Chrome.	\$16.95
67791-91T	Eagle Wing.	\$30.95

Headlamp

Fits 5-3/4" Headlamp. (Does not fit Springer™, XL883C, XL1200C, XL1200NS, XL1200V, '18-later Softail models, or models with Accessory Headlamp Trim Rings.)

67750-88T	Classic Chrome.	\$17.95
67751-91T	Eagle Wing.	\$30.95

Passing Lamp

Fits all Passing Lamps. ('87-later models require Passing Lamp Trim Rings P/N 68775-93TA.) (Does not fit models with Passing Lamp Trim Rings P/N 69622-99B or 69732-05.) Sold in pairs.

69795-07	Skull.	\$29.95
67783-78T	Classic Chrome.	\$22.95
67796-91T	Eagle Wing.	\$33.95

Flat Lens Turn Signal

Fits front turn signals on '88-'17 FLSTC, '94-later FLHR, '07-later FLHRC, '86-'09 FLHT, '86-'13 FLHTC, '89-'13 FLHTCU and '10-'13 FLHTK models. Sold in pairs.

67734-88T	Classic Chrome.	\$20.95
67735-91T	Eagle Wing.	\$32.95

Flat Lens Turn Signal

Fits rear turn signals on '86-'92 FXRT, '86-'90 FLST, '88-'17 FLSTC, '94-later FLHR, '07-later FLHRC, '86-'09 FLHT, '86-'13 FLHTC, '89-'13 FLHTCU and '10-'13 FLHTK models. Also fits front and rear turn signals on '88-'91 FLTC, '89-'96 FLTCU and '99-'03 FLTR models. Sold in pairs.

67737-88T	Classic Chrome.	\$20.95
67738-91T	Eagle Wing.	\$32.95

Also available:

ROAD KING® HEADLAMP VISOR MOUNTING KIT

Allows 7" headlamp visors to be mounted on Road King® motorcycle.

67761-96		\$5.95
-----------------	--	---------------

Fits '94-later FLHR, FLHRC and FLHRXS models. Visor and Trim Ring not included.

Also available:

PASSING LAMP TRIM RINGS

68775-93TA		\$26.95
-------------------	--	----------------

Replaces Original Equipment P/N 68725-62. Required for proper installation of H-D® Passing Lamp Visors on '87-later models (except FXSTD).



A. SKULL COLLECTION LAMP VISORS



A. CLASSIC CHROME LAMP VISORS



A. EAGLE WING LOGO LAMP VISORS

Notice: The prices appearing in this catalog are the manufacturer's suggested retail prices. Actual retail prices may vary.



B. BULLET TURN SIGNAL TRIM RINGS – VISOR STYLE



B. BULLET TURN SIGNAL TRIM RINGS – FRENCH STYLE



C. BULLET TURN SIGNAL VISOR TRIM RINGS – BLACK

B. BULLET TURN SIGNAL TRIM RINGS

Trim ring contour matches the turn signal housing and extends out past the lens for a sleek appearance. These easy-to-install chrome-plated trim rings look great alone or in combination with Headlamp Trim Rings. Available in Visor Style for a nostalgic look or in Trim Ring style for contemporary frenched contour. Sold in pairs.

Front or Rear, Amber Lenses

Fits models equipped with bullet style turn signals (except models equipped with stop/tail/turn lights).

69756-05	Amber, Visor Style.	\$33.95
69739-01	Amber, Frenched Style.	\$33.95

Front, Lenses with Amber Bulbs

Fits models equipped with front bullet style turn signals (except models equipped with Original Equipment or Accessory LED turn signals).

69758-05	Smoked, Visor Style.	\$36.95
69752-04	Smoked, Frenched Style.	\$36.95
69760-05	Clear, Visor Style.	\$36.95

Rear, Lenses with Amber Bulbs

Fits models equipped with bullet style turn signals (except models equipped with stop/tail/turn lights).

69759-05	Smoked, Visor Style.	\$36.95
69753-04	Smoked, Frenched Style.	\$36.95
69761-05	Clear, Visor Style.	\$36.95

Rear, Red Lenses

Fits rear of models equipped with bullet style turn signals (except models equipped with stop/tail/turn lights).

69757-05	Red, Visor Style.	\$33.95
69736-02	Red, Frenched Style.	\$33.95

C. BULLET TURN SIGNAL VISOR TRIM RING – BLACK

Visor-shaped trim rings add a traditional look to the contemporary style of the bullet turn signal. These easy-to-install black finish trim rings are available with smoked or red lenses to match your customizing direction. Sold in pairs.

73342-09 Front, Smoked Lens, Amber Bulb. **\$36.95**
Fits '08-later XL883N, XL1200N, XL1200NS, XL1200X and XL1200XS, '11-'13 XL1200C, '16-later XL1200CX and '08-later FL Softail® (except FLDE) models. Does not fit FLSTC or models equipped with Original Equipment or accessory LED signal lamps.

73343-09 Rear, Smoked Lens, Amber Bulb. **\$36.95**
Fits '09-'17 FLSTSB models (except models equipped with Original Equipment or accessory LED turn signals).

73344-09 Rear, Red Lens. **\$33.95**
Fits '08-later XL883N and XL1200N, '18-later XL1200NS and XL1200XS, '11-later XL1200C, '16-later XL1200CX and '08-'13 XL1200V and XL1200X models (except models equipped with Original Equipment or accessory LED turn signals). Also fits FL Softail models equipped with Auxiliary Turn Signal and Brake Light Kit P/N 69462-06B.

Model Family Fitment:

- V-ROD
- SPORTSTER
- DYNA
- SOFTAIL
- TOURING

Notice: The prices appearing in this catalog are the manufacturer's suggested retail prices. Actual retail prices may vary.

732 LIGHTING

Turn Signals

A. CUSTOM TOURING FRONT BULLET TURN SIGNAL KIT

Add the lean, stripped-down look of the FLHX models to your Electra Glide® or Road King® motorcycle. Complete kit replaces the Original Equipment passing lamps and flat lens turn signal mounts with streamlined bullet-style turn signals. The chrome-plated brackets serve as stylized mounting points for the turn signals and conceal the wiring for a clean, custom appearance.

69577-06A Chrome with Amber Lens. **\$159.95**
Fits '94-later Road King (except FLHRXS) models.

69492-05 Chrome with Amber Lens. **\$144.95**
Fits '96-'13 FLHT and FLHTC, '05-'13 FLHTCU and FLHTK and '09-'13 FLHTCUTG models. Will not fit vehicles equipped with Non-Vented Fairing Lower.

67800167 Gloss Black with Smoked Lenses. **\$139.95**
Fits '96-'13 FLHT, FLHTC and FLHX, '05-'13 FLHTCU and FLHTK and '09-'13 FLHTCUTG models. Will not fit vehicles equipped with Non-Vented Fairing Lower.



A. CUSTOM TOURING FRONT BULLET TURN SIGNAL KIT – CHROME

B. STREET GLIDE® FRONT BULLET TURN SIGNAL MOUNT KIT – GLOSS BLACK

Complement the lean, stripped-down look of your Street Glide® model. Manufactured from Original Equipment components, these rich gloss black Turn Signal Mounts replace the factory-installed chrome mounts to complete the blacked-out look. The brackets serve as stylized mounting points for the Original Equipment or accessory LED bullet turn signals, and conceal the wiring for a clean, custom appearance. Kit includes left and right mounting bracket.

67800706 **\$99.95**
Fits '14-later FLHX, FLHXS and FLHXSE models.



A. CUSTOM TOURING FRONT BULLET TURN SIGNAL KIT – GLOSS BLACK

C. ROAD GLIDE® FRONT BULLET TURN SIGNAL MOUNTS – GLOSS BLACK

Complete the sinister look of your Road Glide® model. Manufactured from Original Equipment components, these rich gloss black Turn Signal Mounts replace the factory-installed chrome mounts, and continue the blacked-out look. The brackets serve as stylized mounting points for the Original Equipment or accessory LED bullet turn signals, and are the perfect complement to Gloss Black Fairing Support P/N 47200278, a gloss black engine guard and gloss black front end components. Kit includes right and left hand mounts.

67800707 **\$69.95**
Fits '15-later Road Glide models.



B. STREET GLIDE FRONT BULLET TURN SIGNAL MOUNT KIT – GLOSS BLACK



C. ROAD GLIDE FRONT BULLET TURN SIGNAL MOUNTS – GLOSS BLACK

Notice: The prices appearing in this catalog are the manufacturer's suggested retail prices. Actual retail prices may vary.



D. LED BULLET TURN SIGNAL INSERT KIT



D. LED BULLET TURN SIGNAL INSERT KIT – AMBER (SHOWN WITH CLEAR LENS)



D. LED BULLET TURN SIGNAL INSERT KIT – RED (SHOWN WITH CLEAR LENS)



E. LENSES FOR LED BULLET TURN SIGNAL INSERTS – AMBER



E. LENSES FOR LED BULLET TURN SIGNAL INSERTS – SMOKED



E. LENSES FOR LED BULLET TURN SIGNAL INSERTS – CLEAR



E. LENSES FOR LED BULLET TURN SIGNAL INSERTS – RED

D. LED BULLET TURN SIGNAL INSERT KIT

Grab the attention of the traffic around you. These LED Turn Signal Inserts feature a single bright, fast-acting amber or red LED lamp sealed in a waterproof housing. The multi-faceted reflector amplifies the light, and the focused lens spreads the light across the lamp's surface. The drop-in lamp assembly replaces the bulb and reflector in the stock bullet turn signal housing for a simple on-bike installation, and the included plug-in harness and crimp connectors attach directly to the existing turn signal wiring. Installation does not require a control box or load equalizer for correct operation. Kit includes 2 LED modules, 2 wiring harnesses, and crimping connectors. Customize the look with your choice of outer lens cover color. Lenses sold separately. Amber Inserts are DOT/ECE compliant. Red Inserts are DOT compliant.

Fits '14-later XL, '12-'16 FLD and FXDC, '12-'17 FLS and FLSS, '11-'17 FLSTN and FXST, '16-'17 FLSTF, FLSTFB, FLSTFBS and FXSB, '12 FLSTSE, '18-later Softail® (except FLDE and FXDRS) and '14-later Touring and Trike models.

67800639	Amber LED Insert.	\$89.95
67800640	Red LED Insert.	\$89.95

E. LENSES FOR LED BULLET TURN SIGNAL INSERTS

Add a unique touch to your bike. These Turn Signal Lens Kits replace the Original Equipment lenses when you install LED Bullet Turn Signal Inserts P/N 67800639 or 67800640. Available in amber, clear, smoked and red to match your style or functional needs. Kit contains 2 lenses.

67800642 Amber Lenses. **\$12.95**
For use with Amber LED Bullet Turn Signal Insert Kit. Fits most models with Original Equipment bullet style turn signals. Does not fit accessory LED Bullet Turn Signal Kit or models with sealed LED rear turn signals. ECE/DOT compliant.

67800643 Smoked Lenses. **\$12.95**
For use with Amber or Red LED Bullet Turn Signal Insert Kit. Fits most models with Original Equipment bullet style turn signals. Does not fit accessory LED Bullet Turn Signal Kit or models with sealed LED rear turn signals. ECE/DOT compliant with Amber insert. DOT compliant with Red insert.

67800644 Clear Lenses. **\$12.95**
For use with Amber or Red LED Bullet Turn Signal Insert Kit. Fits most models with Original Equipment bullet style turn signals. Does not fit accessory LED Bullet Turn Signal Kit or models with sealed LED rear turn signals. ECE/DOT compliant with Amber insert. DOT compliant with Red insert.

67800645 Red Lenses. **\$12.95**
For use with Red LED Bullet Turn Signal Insert Kit. Fits most models with Original Equipment bullet style turn signals or models with sealed LED rear turn signals. Does not fit accessory LED Bullet Turn Signal Kit or models with sealed LED rear turn signals. DOT compliant.

Model Family Fitment:

■ V-ROD	■ SPORTSTER	■ DYNA
■ SOFTAIL	■ TOURING	

Notice: The prices appearing in this catalog are the manufacturer's suggested retail prices. Actual retail prices may vary.

734 LIGHTING

Turn Signals

A. LED BULLET TURN SIGNAL KIT

These Turn Signals feature fast-acting, extra bright LEDs set in compact bullet-shaped die-cast chrome housings. In the front, the lights function as running light and directional indicators. In the rear, the lights function as running light, brake light and directional indicators. The front amber lights are available in your choice of smoked or amber lens and the red rear lights are offered with either smoked or red lens. Installation does not require installation of a "control box" or load equalizer and the turn signals attach directly to existing wiring without cutting or splicing. Featuring a Bar & Shield™ medallion, these signals are the perfect match for the available LED Tail Lamps. Sold in pairs. Meets DOT requirements.

Fits '14-later Touring and Tri Glide® models with bullet turn signals.

67800477	Chrome – Amber Lens.	\$199.95
67800478	Chrome – Smoked Lens.	\$199.95
67800479	Black – Amber Lens.	\$199.95
67800480	Black – Smoked Lens.	\$199.95

Fits '12-'17 Dyna® (except '15-'17 FXDBC), '11-'17 FLS, FLSS, FLSTF, FLSTFB, FLSTFBS and FXS, '08-'11 FLSTSB. Does not fit '11-'12 FLSTSE models.

67800061	Front, Amber Lens.	\$199.95
67800060	Front, Smoked Lens.	\$199.95

Fits '12-'17 FXDC, '12-'13 FXDF, '11-'17 FLS, FLSS, FLSTF, FLSTFB and FLSTFBS, '08-'11 FLSTSB. Does not fit '11-'12 FLSTSE models. Not for use with Layback License Plate Kit P/N 60215-06.

67800055A	Rear, Smoked Lens.	\$199.95
67800056A	Rear, Red Lens.	\$199.95

B. TURN SIGNAL LENS KIT – SMOKED AND CLEAR

Add a unique touch to your bike. These Turn Signal Lens Kits replace the amber lenses for a clean front and rear appearance. Available in clear and smoked versions. Meets DOT requirements.

Fits '00-later models with bullet turn signals (except VRSC™ and models equipped with rear red lens stop/turn/tail signals). Will also fit V-Rod® models equipped with Chrome Turn Signal Kit P/N 69374-05 or 69065-05. Kit includes 4 lenses and 4 amber bulbs.

69303-02	Clear – Bullet Lens.	\$39.95
69304-02	Smoked – Bullet Lens.	\$39.95

Fits front lenses on '08-later XL883N, XL1200CX, XL1200N, XL1200T and XL1200X, '11-later XL1200C and XL1200V, '16-'17 FXDLS, '12-'17 FLS and FLSS, '08-'11 FXCW and FXCWC, '11-'13 FXS and '16-'17 FXSE models. This kit includes 2 lenses and 2 amber bulbs.

69208-09	Smoked – Bullet Lens.	\$24.95
-----------------	-----------------------	----------------



A. LED BULLET TURN SIGNAL KIT – TOURING, CHROME



A. LED BULLET TURN SIGNAL KIT – TOURING, GLOSS BLACK



A. LED BULLET TURN SIGNAL KIT – AMBER LENS



A. LED BULLET TURN SIGNAL KIT – SMOKED LENS



A. LED BULLET TURN SIGNAL KIT – RED LENS



B. TURN SIGNAL LENS KIT – CLEAR, BULLET LENS



B. TURN SIGNAL LENS KIT – SMOKED, BULLET LENS

Notice: The prices appearing in this catalog are the manufacturer's suggested retail prices. Actual retail prices may vary.

LIGHTING 735

Turn Signals



NEW



NEW

C. LED BULLET FRONT TURN SIGNAL KIT – BLACK

C. LED BULLET TURN SIGNAL KIT – BLACK

Grab the attention of the traffic around you. These LED Turn Signals feature a single bright, fast-acting amber or red LED lamp sealed in a waterproof housing. The multi-faceted reflector amplifies the light, and the focused lens spreads the light across the lamp's surface. The complete lamp and housing assembly replaces the stock bullet turn signal housing, and the wiring harness connects to the existing turn signal wiring without splicing. Installation does not require a control box or load equalizer for correct operation. Kit includes 2 pre-wired LED turn signal modules mounted in black bullet housings. Customize the look with your choice of outer lens cover color. Lenses sold separately. Amber Inserts are DOT/ECE compliant. Red Inserts are DOT compliant.

67800977 Front, Amber LED. **\$249.95**
Fits '18-later FLFB, FLFBS, FLSB and FXLR models. Kit includes LED lamps, black housings and black turn signal mounts.

67800978 Rear, Amber LED. **\$249.95**
Fits '18-later FXLR models. Kit includes LED lamps, black housings and black turn signal mounts.

67800981 Rear, Red LED. **\$249.95**
Fits 18-later FLFB and FLFBS models. Kit includes LED lamps, black housings and black turn signal mounts.

67800982 Rear Light Bar, Amber LED. **\$299.95**
Fits 18-later FLHC and FLHCS models. Kit includes LED lamps, black housings and black light bar.



NEW



NEW

C. LED BULLET REAR TURN SIGNAL KITS – BLACK

C. LED BULLET TURN SIGNAL KIT – BLACK – REAR LIGHT BAR

D. BULLET TURN SIGNAL HOUSINGS – BLACK

Complete the blacked-out look. Kit contains two black bullet-shaped turn signal housings that have been pre-wired for installation. Just add the Original Equipment LED Turn Signal Inserts from the stock chrome housings.

67800980 Rear. **\$99.95**
Fits 18-later FLSB models. Kit includes LED lamps and black housings.



NEW



NEW

D. BULLET TURN SIGNAL HOUSINGS – BLACK

Model Family Fitment:

- V-ROD
- SPORTSTER
- DYNA
- SOFTAIL
- TOURING

Notice: The prices appearing in this catalog are the manufacturer's suggested retail prices. Actual retail prices may vary.

LIGHTING

736 LIGHTING

Turn Signals

A. LED FLAT LENS TURN SIGNALS

Beautiful signature light for models with Flat Lens Turn Signals. These turn signals feature fast-acting, extra bright LEDs set in low-profile die-cast chrome housings. In the front, the lights function as running light and directional indicators. In the rear, the lights function as running light, brake light and directional indicators. The front amber lights are available in your choice of smoked or amber lens and the red rear lights are offered with either smoked or red lens. Installation does not require installation of a "control box" or load equalizer and the turn signals attach directly to existing wiring without cutting or splicing. Featuring pillow-style optics, a horizontal chrome band and a Bar & Shield™ medallion, these signals are the perfect match for the available LED Tail Lamps. Sold in pairs. Meets DOT requirements.



A. LED FLAT LENS TURN SIGNAL – AMBER



A. LED FLAT LENS TURN SIGNAL – SMOKED

Fits '14-later Touring models equipped with flat lens turn signals.

67800374	Front, Amber Lens.	\$189.95
67800375	Front, Smoked Lens.	\$189.95

Fits '01-'17 FLSTC and '01-'13 Touring models equipped with flat lens turn signals.

68411-10	Front, Amber Lens.	\$189.95
68435-10	Front, Smoked Lens.	\$189.95

Fits '99-'17 FLSTC and '01-later Touring models equipped with flat lens turn signals.

68127-10	Rear, Smoked Lens.	\$189.95
68128-10	Rear, Red Lens.	\$189.95

B. TURN SIGNAL LENS KIT – SMOKED AND CLEAR

Add a unique touch to your bike. These Turn Signal Lens Kits replace the amber lenses for a clean front and rear appearance. Available in clear and smoked versions. Meets DOT requirements.

Fits '86-later models with Flat Turn Signal Lenses. Kit includes 4 lenses and 4 amber bulbs.

69307-02	Clear – Flat Lens.	\$39.95
69308-02	Smoked – Flat Lens.	\$39.95



A. LED FLAT LENS TURN SIGNAL – RED



C. BULLET STYLE TURN SIGNAL KIT

Streamline the styling by replacing the front and rear flat lens turn signal lamps with sleek bullet signals. The bullet-shaped housings attach to the Original Equipment turn signal mounting brackets. The kit includes two front and two rear turn signal assemblies and the necessary hardware for installation.

Fits '96-'17 FLSTC, '93-'96 FLSTN, '94-later FLHR and FLHRC, '94-'13 FLHT, FLHTC and FLHTCU and '98-'03 FLTR models.

69153-03A	Smoked Lens and Amber Bulb, Domestic.	\$139.95
69063-03A	Amber Lens and Clear Bulb, Domestic.	\$139.95



B. TURN SIGNAL LENS KIT – FLAT LENS, CLEAR



B. TURN SIGNAL LENS KIT – FLAT LENS, SMOKED



C. BULLET STYLE TURN SIGNAL KIT – FRONT, SMOKED LENS



C. BULLET STYLE TURN SIGNAL KIT – REAR, SMOKED LENS

Notice: The prices appearing in this catalog are the manufacturer's suggested retail prices. Actual retail prices may vary.

Turn Signal Relocation Kits



D. FRONT TURN SIGNAL RELOCATION KIT – (69433-08A SHOWN)



D. FRONT TURN SIGNAL RELOCATION KIT

Styled to blend with the lower triple clamp. This chrome-plated Turn Signal Relocation Kit moves the Original Equipment bullet-style turn signals from the handlebar to the front fork for a clean, streamlined look. Kit includes left and right mounting stalk and all required hardware.

69433-08A \$99.95

Fits '08-'17 Dyna® models (except FLD and FXDSE).

68564-06 \$29.95

Fits '06-'07 Dyna models (except FXDSE).

58742-05 \$59.95

Fits '93-'05 FXDWG, '86-'15 FXST, FXSTB and FXSTC and '00-'07 FXSTD models.

E. FRONT TURN SIGNAL RELOCATION KIT

This kit includes the required hardware and wiring to move the front directional from the handlebar to the lower triple clamp.

Fits '88-later XL (except XL1200CX, XL1200T, XL1200X, XL1200XS and '11-later XL883L and XL1200C) and '91-'05 Dyna models (except FXDWG and FXDXT).

68517-94A Chrome. \$39.95

68643-09 Gloss Black. \$34.95

Fits '10-'15 XL1200X models.

67800452 Satin Black. \$39.95

Fits '16-later XL1200X and XL1200XS models.

67800557 Gloss Black. \$99.95

F. FRONT TURN SIGNAL SWIVEL ASSEMBLY KIT – CHROME

Add a subtle chrome detail to match your own chrome accessories with this swivel kit, a durable stylish replacement for the stock zinc-plated swivel.

68185-00 \$24.95

Fits '88-'03 XLH883, XLH883 Hugger™, XL1200C and XL1200S, '88-later FXR, FXRS and FXLR, '91-'08 FXDWG, '91-later FXD, FXDL, FXDX and FXDXT, '88-'17 FLS, FLSS, FLSTF, FLSTFB, FLSTFBS, FXST, FXSTB, FXSTC, FXSTD, FXSTS and FXSTSB, '18-later Softail® models (except FLDE, FLHC and FLHCS) and '97-'03 FLSTS models. (Does not fit with Turn Signal Relocation Kits or '03 FXSTDSE or FLHRSE.)

G. FRONT TURN SIGNAL MOUNT KIT – CHROME

Chrome left and right turn signal mounting bracket with swivel adjustment. Fits models equipped with handlebar mounted bullet front turn signals.

68266-03 \$69.95

Fits XL (except '04-later XL), Dyna and Softail models equipped with handlebar mounted bullet-style turn signals. Stock on '10 FXDWG and '05-later FLSTSC.



E. FRONT TURN SIGNAL RELOCATION KIT – CHROME, (68517-94A SHOWN)



E. FRONT TURN SIGNAL RELOCATION KIT – GLOSS BLACK, (68643-09 SHOWN)



67800452



67800557

E. FRONT TURN SIGNAL RELOCATION KIT – XL1200X MODELS



F. FRONT TURN SIGNAL SWIVEL ASSEMBLY KIT – CHROME



G. FRONT TURN SIGNAL MOUNT KIT – CHROME

Model Family Fitment:

- V-ROD
- SPORTSTER
- DYNA
- SOFTAIL
- TOURING

Notice: The prices appearing in this catalog are the manufacturer's suggested retail prices. Actual retail prices may vary.

738 LIGHTING

Turn Signals

A. NARROW REAR DIRECTIONAL BAR – CHROME

Enhance the rear profile of your Softail® or Touring model with this Narrow Chrome Directional Bar that enhances the visual proportions of the bike. At 10 inches wide, this die-cast, chrome-plated bar is 3 inches shorter than the stock bar and features the same great quality.

68611-98 **\$50.95**

Fits '86-'17 FLST and FLSTC, '93-'96 FLSTN, '09-'13 FLHTC, FLHTCU and FLHTK and '91-'08 Touring models (except '04-later FLHRS and FLTR). (Does not fit with Flat Lens Turn Signal Module P/N 91699-99A.)



A. NARROW REAR DIRECTIONAL BAR – CHROME

B. BULLET REAR TURN SIGNAL BAR KIT – CHROME

Give your bike a new sporting attitude with the Bullet Turn Signal Kit. The chrome-plated bar and bullet turn signal housings provide a custom look and the narrow profile places the signal lamps between the saddlebag and the rear fender for a sleek appearance.

Fits '99-'08 Touring models (except FLHX), '09-'13 FLHRC, FLHTC, FLHTCU, and FLHTK models (Original Equipment on FLTRU). Also fits '99-later FLST and FLSTC models. Will not fit FLSTC models with '00-later Original Equipment Heritage Classic Saddlebags.

68615-04 Domestic. **\$159.95**

68617-04 International. **\$154.95**



B. BULLET REAR TURN SIGNAL BAR KIT – CHROME

C. BULLET REAR TURN SIGNAL BAR AND LICENSE PLATE RELOCATION KIT

Accent the long and lean look of your Touring bike. This complete kit moves your license plate from the support bar to the rear fender tail for a true custom look. The kit includes a Bullet Turn Signal Bar with integrated down-lighting for the license plate, bullet turn signals, chrome rear fender tip and decorative trim to cover the original license plate mounting holes.

53702-04A **\$269.95**

Fits '99-'08 Touring models. '99-early '03 models require the separate purchase of Tail Light Socket P/N 68370-03A.



C. BULLET REAR TURN SIGNAL BAR AND LICENSE PLATE RELOCATION KIT

D. NARROW MOUNTING KIT FOR REAR TURN SIGNALS

Tuck the rear turn signals close to the fender struts. These sleek chrome-plated turn signal mounts move the Original Equipment bullet turn signals 1 inch closer to the rear fender for a custom narrow profile.

69820-06 **\$38.95**

Fits '02-'17 FXD, FXD35, FXDB, FXDC, FXDL, FXDX, '07-'08 FXDB, '02-'05 FXDWG, '02-'17 FLSTF, FLSTFB, FLSTFBS, FLSTS and FLSTSC and '02-'05 FXST, FXSTS and FXSTB and '18-later Softail models (except FLDE, FLHC, FLHCS, FLSEB and FXDRS). Will not fit with saddlebags or FLD rear light bar.



D. NARROW MOUNTING KIT FOR REAR TURN SIGNALS

Notice: The prices appearing in this catalog are the manufacturer's suggested retail prices. Actual retail prices may vary.

LIGHTING 739

Turn Signals & Brake Lamps



E. AUXILIARY BRAKE LIGHT/RUNNING LIGHT/TURN SIGNAL CONVERSION KIT – FLAT LENS STYLE



E. AUXILIARY BRAKE LIGHT/RUNNING LIGHT/TURN SIGNAL CONVERSION KIT*

Turn signal module adds an auxiliary brake light and running light function to your existing turn signals for auxiliary rear lighting. Red lenses glow when the headlamp is on and increase in intensity when brakes or turn signals are activated. Easy to install, the kit simply plugs into your existing wiring harness. Red turn signal lenses are included. Meets DOT requirements.

68000123A Flat Lens. **\$74.95**
Fits '14-later Touring models equipped with Original Equipment flat lens style turn signals.

69461-06D Flat Lens. **\$69.95**
Fits '96-'17 Softail® and '97-'08 Touring models (except FLHX) equipped with Original Equipment flat lens style turn signals. Also fits '09-'13 FLHR, FLHRC, FLHTC, FLHTCU and FLHTK models. (Does not fit with Narrow Chrome Directional Bar P/N 68611-98.)

69200765A Bullet Lens. **\$69.95**
Fits '14-later XL models (except XL883N, XL1200CX, XL1200N, XL1200NS, XL1200T, XL1200X and XL1200XS).

69462-06D Bullet Lens. **\$69.95**
Fits '02-'03 XL, '02-'17 Dyna® (except FXDXT and '09-'17 FXDB and FXDWG) and '02-'17 Softail (except FXS, FXSB, FXSBSE, FXSTD and FXSTDI) models with stock bullet-style turn signals. (NOTE: Not intended for use on '05-later FLSTN, '04-later FLHRS, FLHTCSE, FLHX and FLTR or models equipped with Bullet Turn Signal Bar Kit P/N 68615-04 or 68617-04. If installed on these models, the system will function properly but will not meet the DOT minimum separation requirements for a red tail light to red turn signal.)

69463-06B Bullet Lens. **\$69.95**
Fits '04-'13 XL models (except XL883N, XL1200N, XL1200X and '11-later XL1200C).

F. TOUR-PAK® BRAKE LIGHT/RUNNING LIGHT/TURN SIGNAL CONVERSION KIT*

Turn signal module adds an auxiliary brake light and turn signal function to your Original Equipment Tour-Pak® rear lighting. Red lenses glow when the headlamp is on and increase in intensity when brakes or turn signals are activated. Easy to install, the kit simply plugs into your existing wiring harness.

69200042A **\$74.95**
Fits '97-'13 FLHTCU, FLHTK, FLTRU, FLHTCUTG and other models equipped with Ultra-style Tour-Pak. (Does not fit '10-'13 FLHTCUSE.)



E. AUXILIARY BRAKE LIGHT/RUNNING LIGHT/TURN SIGNAL CONVERSION KIT



F. TOUR-PAK BRAKE LIGHT/RUNNING LIGHT/TURN SIGNAL CONVERSION KIT

! *WARNING: Disconnecting your DOT required tail, brake and turn signal lighting could reduce your visibility to others and result in death or serious injury.

Model Family Fitment:

- V-ROD
- SPORTSTER
- DYNA
- SOFTAIL
- TOURING

Notice: The prices appearing in this catalog are the manufacturer's suggested retail prices. Actual retail prices may vary.

740 LIGHTING

Rear Lighting

A. LIGHT BAR WITH LED BULLET TURN SIGNALS

These Turn Signals feature fast-acting, extra bright LEDs set in compact bullet-shaped die-cast housings. Available with red or smoked lenses, these lamps glow a bright red color when functioning as brake lamps, running lights and directional indicators. The kit includes the Rear Light Bar with integrated down-lighting for the license plate, bullet lamp housings and wiring. Installation does not require installation of a control box or load equalizer and the turn signals attach directly to existing wiring without cutting or splicing. These LED signals are the perfect match for the available LED Front Turn Signals. Meets DOT requirements.

Fits '17-later FLHRXS and '14-later FLHX, FLHXS, FLTRX, and FLTRXS models with Original Equipment rear bullet stop/turn/tail light bar.

67800493	Black – Red Lens.	\$299.95
67800494	Black – Smoked Lens.	\$299.95
67800491	Chrome – Red Lens.	\$299.95
67800492	Chrome – Smoked Lens.	\$299.95



A. LIGHT BAR WITH LED BULLET TURN SIGNALS – BLACK WITH SMOKED LENSES

B. BULLET REAR LIGHT BAR – GLOSS BLACK

Complete the blacked-out treatment of your custom Touring bike. This complete kit replaces the Original Equipment chrome bar and lamps with a sinister black edition for a minimalistic look. The kit includes the Rear Light Bar with integrated down-lighting for the license plate, bullet lamp housings and wiring.

Fits '10-later Street Glide® and Road Glide® models with Original Equipment rear bullet turn signal light bar.

67800483	Domestic.	\$199.95
67800484	International.	\$399.95



A. LIGHT BAR WITH LED BULLET TURN SIGNALS – CHROME WITH RED LENSES



A. LIGHT BAR WITH LED BULLET TURN SIGNALS



B. BULLET REAR LIGHT BAR – GLOSS BLACK



67800484

Notice: The prices appearing in this catalog are the manufacturer's suggested retail prices. Actual retail prices may vary.

LIGHTING 741

Saddlebag Lighting



C. ELECTRA GLO KEYSTONE AUXILIARY LED RUN/BRAKE/TURN LAMP – BRAKES APPLIED



C. ELECTRA GLO KEYSTONE AUXILIARY LED RUN/BRAKE/TURN LAMP

C. ELECTRA GLO™ KEYSTONE AUXILIARY LED RUN/BRAKE/TURN LAMPS*

Nestled in the fender strut opening, these Keystone LED lamps add stylish and practical lighting to the rear of the bike. The red LED lights emit a soft neon-like glow when the ignition is on and the center row of fast-acting LED lamps burn brightly when the brakes or turn signals are activated. And when the bike is parked, the dark lamps fill the gap between the fender and saddlebags for a clean, uncluttered look. The easy-to-install lamps are mounted in a sealed housing that slips into the opening, and are held in place with the saddlebag support hardware and an adhesive pad. Complete kit includes left and right lamps and a plug-and-play wiring harness.

67800589 **\$299.95**
Fits '14-later FLHTCU, FLHTCUL, FLHTK, FLHTKL and FLTRU models.

D. ELECTRA GLO SADDLEBAG SIDE MARKER LIGHT KIT

This wrap-around Side Marker Light Kit adds a splash of light to the lower edge of the color-matched saddlebags. Available in your choice of red or smoked lens, the bright band of LED lamps is housed in a mirror chrome frame that hugs the bottom of the saddlebag. The low-profile self-adhesive Electra Glo™ lamps can be installed on models equipped with standard-length saddlebags, and are compatible with optional saddlebag guard rails. Easy to install kit includes left and right lamp and quick-disconnect wiring harness.

Fits '14-later Touring models with hard saddlebags. Not compatible with CVO™ or other models equipped with Stretched Saddlebags. '14-later models require separate purchase of Electrical Harness Extension P/N 69200722. '17-later models require Electrical Harness Extension P/N 69201599A.

68000082 Red Lens. **\$249.95**
68000083 Smoked Lens. **\$249.95**



D. ELECTRA GLO SADDLEBAG SIDE MARKER LIGHT KIT – RED LENS



D. ELECTRA GLO SADDLEBAG SIDE MARKER LIGHT KIT – SMOKED LENS



***WARNING:** Disconnecting your DOT required tail, brake and turn signal lighting could reduce your visibility to others and result in death or serious injury.

Model Family Fitment:

V-ROD
 SPORTSTER
 DYNA
 SOFTAIL
 TOURING

Notice: The prices appearing in this catalog are the manufacturer's suggested retail prices. Actual retail prices may vary.

742 LIGHTING

Saddlebag Lighting

A. ELECTRA GLO™ LED SADDLEBAG RUN/BRAKE/TURN LAMP*

Add functional lighting to the rear of your Touring bike. These running, directional and brake lights command the attention of following vehicles. The bright, fast-acting LED lamps glow red when the ignition is on, and intensify when the turn signals or brakes are activated. The lamps act as a supplement to the Tour-Pak® luggage mounted rear lighting. The lamps are housed in a low-profile frame that is contoured to hug the curve of the hard saddlebags. The self-adhesive lamps fit seamlessly beneath the saddlebag lid and add a stylish touch of color, even when the bike is parked. Complete kit includes left and right lamps, modulator and quick-disconnect wiring harness.

Fits '14-later FLHTCU, FLHTCUL, FLHTK, FLHTKL, FLTRU and '16-later FLHTKSE or FLTRUSE models.

67800241A	Chrome Housing/Red Lens.	\$239.95
67800242A	Chrome Housing/Smoked Lens.	\$239.95
67800607	Black Housing/Red Lens.	\$239.95
67800604	Black Housing/Smoked Lens.	\$239.95

Fits '14-later FLHRXS, FLHX, FLHXS, FLTRX and FLTRXS models. Does not fit Canadian models.

67800448A	Chrome Housing/Red Lens.	\$239.95
67800450A	Chrome Housing/Smoked Lens.	\$239.95
67800608	Black Housing/Red Lens.	\$239.95
67800605	Black Housing/Smoked Lens.	\$239.95

Fits '14-later FLHR models, '14-'15 FLHTKSE, '14 FLHRSE, and '15 FLTRUSE models. Also fits Canadian FLHRXS, FLHX, FLHXS, FLTRX and FLTRXS models.

67800449A	Chrome Housing/Red Lens.	\$239.95
67800451A	Chrome Housing/Smoked Lens.	\$239.95
67800609	Black Housing/Red Lens.	\$239.95
67800606	Black Housing/Smoked Lens.	\$239.95



A. ELECTRA GLO LED SADDLEBAG RUN/BRAKE/TURN LAMP



A. ELECTRA GLO LED SADDLEBAG RUN/BRAKE/TURN LAMP – CHROME HOUSING/SMOKED LENS



A. ELECTRA GLO LED SADDLEBAG RUN/BRAKE/TURN LAMP – BLACK HOUSING/RED LENS



A. ELECTRA GLO LED SADDLEBAG RUN/BRAKE/TURN LAMP – BLACK HOUSING/SMOKED LENS



***WARNING:** Disconnecting your DOT required tail, brake and turn signal lighting could reduce your visibility to others and result in death or serious injury.

Model Family Fitment:

- V-ROD
- SPORTSTER
- DYNA
- SOFTAIL
- TOURING

Notice: The prices appearing in this catalog are the manufacturer's suggested retail prices. Actual retail prices may vary.

LIGHTING 743

Saddlebag Lighting



B. ELECTRA GLO STEALTH AUXILIARY LED RUN/ BRAKE/TURN LAMP – ON

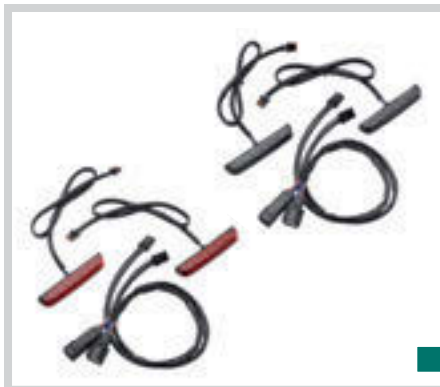

B. ELECTRA GLO STEALTH AUXILIARY LED RUN/BRAKE/TURN LAMP

B. ELECTRA GLO™ STEALTH AUXILIARY LED RUN/ BRAKE/TURN LAMPS*

Keep a low profile while drawing maximum attention. These covert lamps hug the bottom edge of the saddlebags, and provide a subtle band of red light beneath the bike when the ignition is on. To help grab the attention of following drivers, the fast-acting LED lamps increase in intensity when the brakes or turn signals are applied. Strong adhesive pads secure the water- and shock-proof housings to the bags, and the quick-release wiring harness connects to the bike's wiring without splicing. Kit includes left and right lamp and quick-disconnect wiring harness.

Fits '14-later Touring models with standard hard saddlebags. Does not fit models equipped with Original Equipment or accessory Stretched Saddlebags or with some 4.5" accessory mufflers.

67800554	Red Lens.	\$149.95
67800555	Smoked Lens.	\$149.95

Fits '93-'13 Touring models with standard hard saddlebags. Does not fit models equipped with Original Equipment or accessory Stretched Saddlebags.

67800574	Red Lens.	\$149.95
67800575	Smoked Lens.	\$149.95



C. CENTER-MOUNT AUXILIARY RUNNING & BRAKE LIGHT



C. CENTER-MOUNT AUXILIARY RUNNING AND BRAKE LIGHT*

Brilliant red center-mount running and brake light grabs the attention of following vehicles. The fast-acting long life LEDs glow red when ignition is on and intensify when the brakes are applied. The low-profile chrome shell attaches to and hugs the contour of the turn signal bar for a custom look. Plug-in connection for easy installation.

68000119A		\$129.95
------------------	--	-----------------

Fits '14-later FLHX, FLHXS, FLTRX and FLTRXS models.

68000029A		\$129.95
------------------	--	-----------------

Fits '10-'13 FLHX and FLTRX models.

D. TRI-BAR LIGHT UPGRADE – AUXILIARY RUNNING LIGHT/BRAKE LIGHT*

Upgrade the Original Equipment Tri-Bar fender light from a single-mode running light to a dual-mode running and brake light. The three smoked light bands glow red in the running mode and increase in intensity when the brakes are applied.

68358-07A		\$99.95
------------------	--	----------------

Fits '06-'09 FLHX models.

67774-10		\$149.95
-----------------	--	-----------------

Fits '10-later FLHX and FLTRX models (except HDI models).



D. TRI-BAR LIGHT UPGRADE – AUXILIARY RUNNING LIGHT/BRAKE LIGHT



E. REAR FENDER TIP LIGHT – AUXILIARY RUNNING LIGHT/BRAKE LIGHT*

Upgrade your Touring model's Original Equipment fender tip light from a single-mode running light to a dual-mode running and brake light. The brilliant lamp glows red in the running mode and increases in intensity when the brakes are applied. The available smoked or red lenses complement any styling direction. Easy plug-in connection to the Original Equipment wiring harness.

Fits '09-'16 FLHTC, FLHTCU, FLHTCUL, FLHTK, FLHTKL and '16 FLTRU models.

59685-10	Red Lens.	\$99.95
59776-10	Smoked Lens.	\$99.95



E. REAR FENDER TIP LIGHT – AUXILIARY RUNNING LIGHT/BRAKE LIGHT



! *WARNING: Disconnecting your DOT required tail, brake and turn signal lighting could reduce your visibility to others and result in death or serious injury.

Notice: The prices appearing in this catalog are the manufacturer's suggested retail prices. Actual retail prices may vary.

LIGHTING

744 LIGHTING

Tail Lamps – LED

A. LAYBACK LED TAIL LAMP

Shaped to mirror the contour of the rear fender, this Layback LED Tail Light combines style and performance in one. Featuring an array of fast acting red LED lamps arranged in a grid pattern, this bright running lamp outshines traditional incandescent lamps. And when you hit the brakes, you'll grab everyone's attention. Available in your choice of red or smoked lenses, this complete tail lamp assembly features an easy plug-in connection to the Original Equipment wiring harness. Lamp meets ECE requirements.

Fits '99-later XL (except XL883N, XL1200CX, XL1200N, XL1200NS, XL1200V, XL1200X, XL1200XS and '11-later XL1200C), '99-'17 FXDL, '18-later FXLR, FLHC and FLHCS, '03-'15 FXST, FXSTS, FXSTB and FXSTC, '00-'17 FLST, FLSTF, FLSTFB, FLSTFBS, FLSTSB and FLSTC and '99-'08 Touring models (except FLHX, '05 FLHTCSE, '07-'08 FLHRSE and models equipped with License Plate Relocation Kit P/N 53702-04). Also fits '09-later FLHRC, FLHTC, FLHTCU, FLHTK and FLTRU models. Does not fit models with Bobtail fenders.

67800355 Red Lens with Plate Lamp. **\$169.95**
For U.S. and Canada.

67800356 Smoked Lens with Plate Lamp. **\$169.95**
For U.S. and Canada.

67800614 Red Lens with Plate Lamp. **\$169.95**
For all markets (except U.S. and Canada).

67800615 Smoked Lens with Plate Lamp. **\$169.95**
For all markets (except U.S. and Canada).

Fits '07-'08 FLHRSE, '05 FLHTCSE, '06-'09 FLHX, '09-later FLHR (except FLHRXS), FLHT and FLTR and models equipped with License Plate Relocation Kit P/N 53702-04.

67800357 Red Lens. **\$169.95**
For U.S. and Canada.

67800358 Smoked Lens. **\$169.95**
For U.S. and Canada.

67800616 Red Lens. **\$169.95**
For all markets (except U.S. and Canada).

67800617 Smoked Lens. **\$169.95**
For all markets (except U.S. and Canada).

B. CHOPPED FENDER EDGE LIGHT

Style and function in one. This center-mount auxiliary running and brake light commands the attention of following vehicles. The bright, fast-acting LED lamp glows red when the ignition is on and intensifies when the brakes are applied. The low-profile lamp is contoured to hug the curve of the chopped rear fender and adds a stylish touch of color, even when the bike is parked.

73416-11 Red Lens. **\$89.95**
Fits '10-'17 FXDWG models.

73420-11 Red Lens. **\$89.95**
Fits '04-'13 XL883N, XL1200N, XL1200V, XL1200X and models equipped with Chopped Rear Fender Kit P/N 60236-09, 60236-10 and side-mount license plate. Will not fit models with center-mount license plates.

68000105 Red Lens. **\$99.95**
Fits '14-later XL883N, XL1200NS, XL1200V, XL1200X, XL1200XS and '14-later models equipped with Chopped Rear Fender Kit P/N 60236-09, 60236-10 and side-mount license plate. Will not fit models with center-mount license plates.

Model Family Fitment:

- V-ROD
- SPORTSTER
- DYNA
- SOFTAIL
- TOURING

Notice: The prices appearing in this catalog are the manufacturer's suggested retail prices. Actual retail prices may vary.



A. LAYBACK LED TAIL LAMP – SMOKED

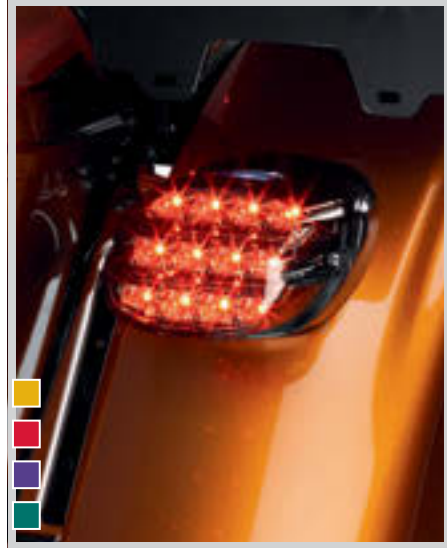

A. LAYBACK LED TAIL LAMP – ON

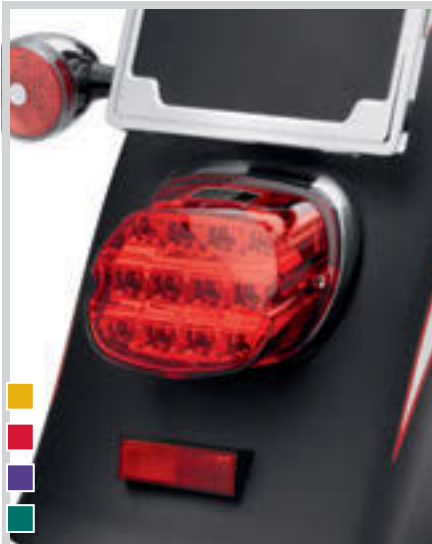

A. LAYBACK LED TAIL LAMP – RED



A. LAYBACK LED TAIL LAMPS



B. CHOPPED FENDER EDGE LIGHT – DYNA WIDE GLIDE

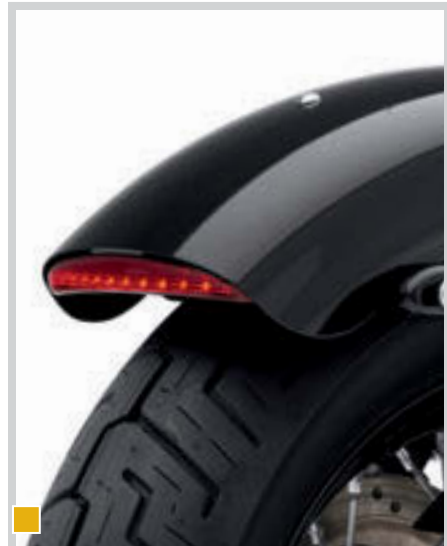

B. CHOPPED FENDER EDGE LIGHT – SPORTSTER

LIGHTING 745

Tail Lamps – LED



**C. LED TAIL LAMP – SMOKED LENS/
CHROME BEZEL – ON**



**C. LED TAIL LAMP –
SMOKED LENS/BLACK BEZEL**



Smoked Lens
Chrome Bezel

Smoked Lens
Black Bezel

C. LED TAIL LAMPS



D. TRI-BAR LED TAIL LIGHT – OFF



D. TRI-BAR LED TAIL LIGHT – ON



E. CUSTOM LED TAIL LAMP – CLEAR LENS



E. CUSTOM LED TAIL LAMP – RED LENS

C. LED TAIL LAMP

Combine LED technology and contemporary styling for a bright new look. Featuring a full array of 20 fast-acting red LED lamps, this brilliant running and brake lamp will grab everyone's attention. Designed to fit the contour of both Bobtail and full rear fenders, the smoked or red lens Bar & Shield logo-accented tail lamp complements any custom direction. The black or chrome bezel is wrapped in a clear outer housing for a mirror-like finish. Easy plug-in connection to the Original Equipment wiring harness.

Fits '06-'09 FLHX, '07 FLHTCUSE, '07-'08 FLHRSE, '09-later Road King®, Electra Glide®, Ultra Limited, Road Glide® and models equipped with License Plate Relocation Kit P/N 53702-04.

68117-08	Smoked Lens/Chrome Bezel.	\$149.95
68118-08	Smoked Lens/Black Bezel.	\$149.95
68116-08	Red Lens/Chrome Bezel.	\$149.95

Fits '09-later FLHTCUTG and '10-'11 FLHXXX models. Sold in pairs.

67800133	Red Lens/Chrome Bezel.	\$349.95
67800134	Smoked Lens/Chrome Bezel.	\$349.95

Fits '15-later FLRT models. Sold in pairs.

67800457	Red Lens/Chrome Bezel.	\$349.95
67800459	Smoked Lens/Chrome Bezel.	\$349.95

D. TRI-BAR LED TAIL LIGHT

This bobtail fender-styled tail lamp features fast-reacting LED lamps behind a smoked outer lens. Internally masked to form three distinct light bands, the smoked lens glows red in the running mode and rapidly increases in intensity when the brakes are applied. The lamp assembly fills the fender opening for a custom look and the minimalist license plate bracket continues the streamlined appearance. Features easy plug-in connection to the Original Equipment wiring harness. DOT and TUV compliant.

69817-07A Smoked Lens. **\$249.95**

Fits '06-'15 FXST, FXSTB, FXSTC, FXSTS and FLSTSB models. Original Equipment on '07-'08 FXSTSSE models. Will fit with Bobtail Fender Racks P/N 53979-07A and 56452-07 when used with Installation Kit P/N 59320-07A. Does not fit with Bobtail Fender Rack P/N 56452-07, 60161-06 or 53979-07.

E. CUSTOM LED TAIL LAMP

Function and style in one. Twenty-three brilliant red LED lamps are set in a mirror-finished chrome inner reflector. The diamond cut facets shape and direct the light and add a style all their own. Available with a red or clear outer lens, the installed lens adds a red metallic or chrome finishing touch to the rear fender. Featuring easy plug-in connection to the Original Equipment wiring harness. Meets DOT and TUV requirements.

Fits '02-'11 VRSC™ models (except VRSCF) and '00-'07 FXSTD models.

69367-07	Clear Lens with Chrome Reflector.	\$139.95
69366-07	Red Lens with Chrome Reflector.	\$139.95

LIGHTING

Notice: The prices appearing in this catalog are the manufacturer's suggested retail prices. Actual retail prices may vary.

746 LIGHTING

Tail Light Visors

A. TAIL LIGHT VISORS

Mirror-finish chrome visor dresses the tail light in style. Available in your choice of design, this easy to install visor adds a finishing touch.

Fits '73-later models (except VRSC™, XG, XR, XL883N, XL1200CX, XL1200N, XL1200V, XL1200X, FXDF, FXDLS, FXDWG, FXWG, FLS, FLBS, FLSS, FLSTN, FLSTS, FLSTSB, FX Softail®, FXSE, FLHX, FLHTCUTG, FLRT, FLTRX and FLTRXS, '11-later XL1200C, '09-'17 FXDB, '14-later FLHX, FLHRSE and FLHTKSE and '09-later FLHR and FLTR models).

68006-83T	Classic Chrome.	\$21.95
68011-91T	Eagle Wing Gold.	\$31.95
68011-88T	Eagle Wing Chrome (not shown).	\$23.95



A. TAIL LIGHT VISOR – CLASSIC CHROME



A. GOLD TAIL LIGHT VISOR – EAGLE WING

B. TAIL LIGHT COLLAR – CHROME

This chrome-plated ABS tail light collar dramatically changes the appearance of your rear fender. The collar is easy to install and the kit includes all mounting hardware.

68311-01 \$35.95
Fits '73-later models (except VRSC, XG, XR, XL883N, XL1200CX, XL1200N, XL1200V, XL1200X, FXDF, FXDLS, FXDWG, FXWG, FLS, FLBS, FLSS, FLSTN, FLSTS, FLSTSB, FX Softail, FXSE, FLHX, FLHTCUTG, FLRT, FLTRX and FLTRXS, '11-later XL1200C, '09-'17 FXDB, '14-later FLHX, FLHRSE and FLHTKSE and '09-later FLHR and FLTR models).

68332-08 \$35.95
Fits '06-'09 FLHX and '09-later FLHR, FLHRC and FLHT and '06-'09 FLTR and FLHTCUTG models with Original Equipment tail lamp. Also fits Touring models equipped with Bullet Turn Signal and License Plate Relocation Kit P/N 53702-04A.



B. TAIL LIGHT COLLAR – CHROME



C. LED FENDER TIP LENS – SMOKED FRONT FENDER

C. LED FENDER TIP LENS – SMOKED

Add a custom look to the fender tip lens on your bike. Smoked lenses replace the Original Equipment lenses and self-contained LED lamp replaces the bulb.

59338-09 Front Fender. \$23.95
Fits '86-'08 FLSTC, '93-'96 FLSTN and '80-'13 FLHR, FLHS, FLHT and FLT models. Does not fit models with clean front fender.

59336-09 Rear Fender. \$23.95
Fits '86-'08 FLSTC, '93-'96 FLSTN and '80-'08 FLHR, FLHS, FLHT and FLT models.

59380-05 Front and Rear Fender. \$44.95
Fits '86-'08 FLSTC, '93-'96 FLSTN and '80-'08 FLHR, FLHS, FLHT and FLT, '86-'08 FLSTC and '93-'96 FLSTN models. Does not fit FLST, FLSTS, FLSTSB, FLSTSC, FLHRS, FLHX, FLTR or models equipped with clean front fender.

D. CURVED LICENSE PLATE FRAME – SOFTAIL® DELUXE

Love the look of your bike but hate the appearance of your state-mandated license plate? This stylish Curved License Plate Frame is shaped to hug the contour of the rear fender and layback design reduces the "in-your-face" look of the flat, unfinished plate. Designed to replace the upright license plate mount, the front frame cover hides the plate's holes and raw edges and the solid backing plate conceals the unfinished rear side of the plate. Available in chrome, the complete kit includes all required mounting hardware.

67900007 Chrome. \$94.95
Fits '05-'17 FLSTN and '05-'07 FLSTSC models.



D. CURVED LICENSE PLATE FRAME – SOFTAIL DELUXE, CHROME

E. LAYBACK LICENSE PLATE AND TURN SIGNAL RELOCATION KIT

This kit combines our popular Layback License Plate Mount with an integrated turn signal bar to add a stylish slant to the rear fender. Kit relocates the Original Equipment bullet-style turn signals from the fender strut to the turn signal bar to allow clearance for saddlebags. This kit is a stylish alternative to Turn Signal Relocation Kit P/N 68732-02A and includes all necessary mounting hardware.

60215-06 \$94.95
Fits '04-later XL (except XL883N, XL1200C, XL1200CX, XL1200N, XL1200NS, XL1200T, XL1200V, XL1200X and XL1200XS) and '02-'17 Dyna® models (except FLD, FXDF, FXDWG and '09-'17 FXDB). Does not fit models equipped with side-mount license plates.

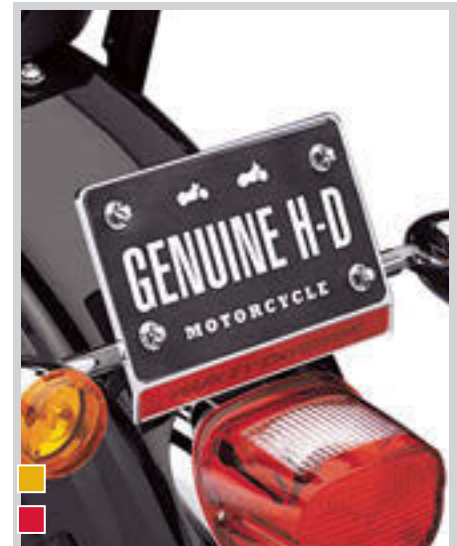

E. LAYBACK LICENSE PLATE AND TURN SIGNAL RELOCATION KIT

Model Family Fitment:

- V-ROD
- SPORTSTER
- DYNA
- SOFTAIL
- TOURING

Notice: The prices appearing in this catalog are the manufacturer's suggested retail prices. Actual retail prices may vary.



F. CURVED LICENSE PLATE FRAME WITH LED LIGHTING – CHROME



F. CURVED LICENSE PLATE FRAME WITH LED LIGHTING – GLOSS BLACK



G. CURVED LICENSE PLATE FRAME – TOURING, CHROME



G. CURVED LICENSE PLATE FRAME – TOURING, GLOSS BLACK

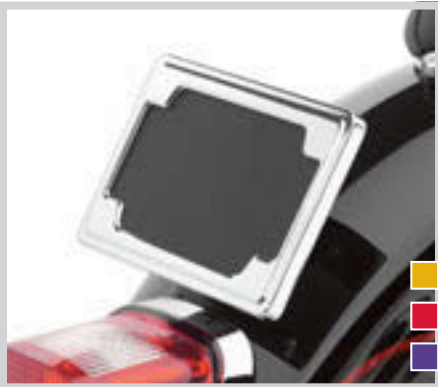

H. FRAMED LAYBACK LICENSE PLATE MOUNT – FENDER TOP



H. FRAMED LAYBACK LICENSE PLATE MOUNT – TOURING



I. LAYBACK LICENSE PLATE MOUNT – FENDER TOP



I. LAYBACK LICENSE PLATE MOUNT – TOURING

F. CURVED LICENSE PLATE FRAME WITH LED LIGHTING

Dress up the rear of your Street Glide® or Road Glide® model and add practical auxiliary lighting at the same time. Designed to replace the Original Equipment black license plate bracket, this curved license plate frame is shaped to hug the contours of the rear fender. The mount attaches to the underside of the rear turn signal bar, and the smooth license plate frame with signature Harley-Davidson script appears to float above the fender for a custom look. The frame features two vertical LED halo lights that glow while in the run mode and burn brightly when the brakes are applied. Kit includes all necessary harnesses and connectors to enable complete installation – no drilling or wire splicing is required. Available in your choice of chrome or gloss black finish.

Fits '10-later FLHRXS, FLHX, FLHXS, FLTRX and FLTRXS models.

67900275	Chrome.	\$159.95
67900273	Gloss Black.	\$159.95

G. CURVED LICENSE PLATE FRAME – TOURING

Love the look of your bike but hate the appearance of your state-mandated license plate? This stylish Curved License Plate Frame is shaped to hug the contour of the rear fender. Designed to replace the Original Equipment black license plate bracket, installation requires no drilling or rewiring. The front frame cover conceals the plate's mounting holes and raw edges and the curved shape hides the unfinished rear side of the plate. Available in chrome or gloss black finish, the complete kit includes all required mounting hardware.

Fits '10-later FLHRXS, FLHX, FLHXS, FLHXSE, FLTRX and FLTRXS models.

67900008	Chrome.	\$94.95
67900058	Gloss Black.	\$94.95

Fits '09, FLHR, FLHT and FLTR and '06-'08 FLHX models.

67900056	Chrome.	\$94.95
-----------------	---------	----------------

H. FRAMED LAYBACK LICENSE PLATE MOUNT

Wrap your license plate in chrome. This mirror-finish license mount tips the plate back for a sleek appearance and conceals the mounting hardware for a custom look. The front frame covers the license holes and the mirror-smooth back plate hides the unfinished rear of the plate. Kit accepts plates measuring to 7.25" x 4.25" (184 x 108mm). Kit includes installation hardware and rear fender reflector.

60193-07 Fender Top. **\$74.95**

Fits license plate up to 7-1/4" x 4-1/4". Fits models with a three-hole rear fender mount license plate bracket. (Does not fit VRSC™, XL883N, XL1200CX, XL1200N, XL1200NS, XL1200T, XL1200V, XL1200X, XL1200XS, FLD, FXDS-CONV, FXDXT, FLSTS, FXCW, FXCWC, Touring, Trike, models with a Bobtail Rear Fender, '00-'01 FXDX, '11-later XL1200C, '09-'17 FXDB and '10-'17 FLS, FLSS, FXDWG, FXS, FXSB and FXSBSE models). (Check for clearance before installing with rear fender rack.)

60210-07 Touring. **\$74.95**

Fits '99-'08 Road King®, Road Glide and Electra Glide® Standard models with 7.25" x 4.25" license plate.

I. LAYBACK LICENSE PLATE MOUNT

Showcase your laid-back attitude by replacing the stand-up license plate mount. Chrome-plated die-cast mount tips the license plate back for a low-profile style. Kit accepts plates measuring to 7.25" x 4.25" (184 x 108mm). Kit includes chrome-plated license mounting hardware, installation hardware and rear fender reflector.

60280-07 Fender Top. **\$49.95**

Fits license plate up to 7.25" x 4.25". Fits models with a three-hole rear fender mount license plate bracket. (Does not fit VRSC™, XL883N, XL1200CX, XL1200N, XL1200NS, XL1200T, XL1200V, XL1200X, XL1200XS, FLD, FXDS-CONV, FXDXT, FLSTS, FXCW, FXCWC, Touring, Trike, models with a Bobtail Rear Fender, '00-'01 FXDX, '11-later XL1200C, '09-'17 FXDB, '18-later Softail® and '10-'17 FLS, FLSS, FXDWG, FXS, FXSB and FXSBSE models). (Check for clearance before installing with rear fender rack.)

60277-07 Touring. **\$44.95**

Fits '99-'08 Road King, Road Glide and Electra Glide Standard models with 7.25" x 4.25" license plate.

748 LIGHTING

License Plate Frames & Mounts

A. HARLEY-DAVIDSON® LICENSE PLATE FRAME

Make your plate shine with this chrome-plated license plate frame, featuring a black paint-filled Harley-Davidson logo. Includes chrome-plated stainless steel mounting hardware.

60051-01 **\$23.95**
Fits 7.25" x 4.25" license plates (except XR, '14-later Touring, '09-later Trike, and models equipped with layback license plate mounting kits or side-mount license plates).



A. HARLEY-DAVIDSON LICENSE PLATE FRAME



B. HARLEY-DAVIDSON SCRIPT LICENSE PLATE FRAME

B. HARLEY-DAVIDSON SCRIPT LICENSE PLATE FRAME

If a license plate is required, you might as well make it look good. This decorative, chrome-plated license plate frame has three-dimensional twist contours, a black Harley-Davidson script and a DOT compliant reflector. Stainless steel mounting hardware included.

59141-98 **\$26.95**
Fits 7.25" x 4.25" license plates (except XR, FXDLS, FXSE, '14-later Touring models, '09-later Trike, and models equipped with layback license plate mounting kits or side-mount license plates).

C. USA LICENSE PLATE FRAME

Ride with pride. This chrome-plated license plate frame combines Bar & Shield logos with multi-color red, white and blue USA lettering. Includes chrome-plated stainless steel mounting hardware.

60065-03 **\$23.95**
Fits 7.25" x 4.25" license plates (except XR, '14-later FLHTCU, FLHTCUL, FLHTK, FLHTKL, FLTRU, '09-later Trike, and models equipped with layback license plate mounting kits or side-mount license plates).

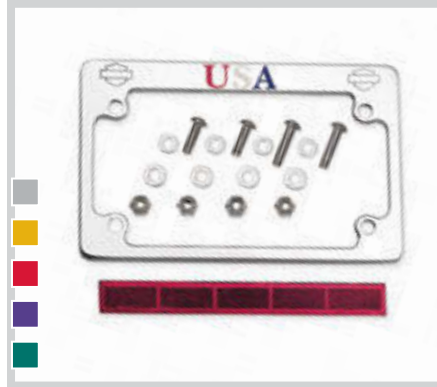

C. USA LICENSE PLATE FRAME

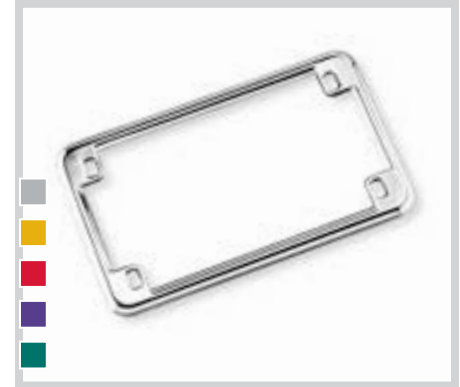

D. LICENSE PLATE FRAME - CHROME

D. LICENSE PLATE FRAME - CHROME

59863-94T **\$16.95**
Fits 7.25" x 4.25" license plates (except XR, XL883N, XL1200CX, XL1200V, XL1200X, FXBB, FLSL, FXFB, FXFBS, FLFB, FLFBS, FXBR, FXBRS, FXDB, FXDF, FXDLS, FXCW, FXCWC, FXSB, FXSE, Trike and '10 FXDWG models).

E. SKULL LICENSE PLATE MOUNTING HARDWARE

Leave them looking at your "attitude." This complete license plate hardware kit features chrome-plated skull-shaped bolts with sinister black-filled eyes. The hardware is installed with a special open wrench to reduce the possibility of license plate theft. Kit includes 4 skull bolts, nuts, lock washers and the special wrench.

94546-05 Universal (except FLHTCUTG). **\$27.95**



E. SKULL LICENSE PLATE MOUNTING HARDWARE



F. BAR & SHIELD LOGO LICENSE PLATE MOUNTING HARDWARE KIT

F. BAR & SHIELD LOGO LICENSE PLATE MOUNTING HARDWARE KIT

Proudly display the Bar & Shield. The Bar & Shield logo shaped bolt heads on this unique chrome-plated stainless steel License Plate Mounting Kit stand out from the pack. The hardware is installed with a custom Bar & Shield logo shaped wrench, reducing the possibility of license plate theft. The kit includes 4 lock nuts, washers, bolts and the special wrench.

94114-02 Universal (except FLHTCUTG). **\$21.95**

G. WILLIE G SKULL COLLECTION LICENSE PLATE HARDWARE KIT

Your bike has an attitude front to back and the final view they see should reflect it. This chrome-plated hardware kit features a skull logo set off by a gloss black background. Sold in sets of 4, includes .25"-20 x .75" fasteners with lock nuts and washers.

41170-03 Universal (except FLHTCUTG). **\$21.95**



G. WILLIE G SKULL COLLECTION LICENSE PLATE HARDWARE KIT



H. BAR & SHIELD LOGO LICENSE PLATE HARDWARE KIT

H. BAR & SHIELD LOGO LICENSE PLATE HARDWARE KIT

This chrome-plated hardware kit features the Bar & Shield logo set against a gloss black background. Kit includes a set of four .25"-20 x .75" fasteners with matching lock nuts and washers.

41161-01 Universal (except FLHTCUTG). **\$21.95**

LIGHTING 749

Horns

I. LICENSE PLATE MOUNTING KIT WITH BUTTON HEAD SCREWS

Kit contains two chrome button head screws, two chrome acorn nuts, two chrome flat washers and two chrome lock washers.

94109-95 Universal fitment. **\$6.95**

J. LICENSE PLATE MOUNTING KIT

Kit contains two chrome .25" acorn nuts, two chrome .25"-20 screws and two chrome .25" lockwashers.

94135-93T Universal fitment. **\$5.95**

K. LOUD SIDE-MOUNT HORN KIT

Get Noticed. Ride with increased confidence with a loud horn that will grab everyone's attention. Engineered to be 5dB louder (at 2 meters) than the '13-earlier Original Equipment side-mounted horn. The loud horn is stocked on '14-later models equipped with side-mount horns. Designed to be a plug-in replacement that is easy to install. Fits all H-D® side-mount horn covers.

69060-90H **\$49.95**

Fits '91-'17 VRSC™, '91-later XL1200C and XL1200V, '91-'17 Dyna® (except '14-'17 FXDL), '91-'17 Softail® (except FLSTS, FLSTSC, FXCW, FXCWC, FXS, FXSB and FXSBSE), '91-later Touring and '09-later Trike models.

L. LOUD HORN KIT

Grab everyone's attention. Engineered to be 3dB louder (at 2 meters) than the Original Equipment front-mounted horn, this Horn Kit is tuned to a frequency that helps cut through the background noise. Designed to be a plug-in replacement for the factory horn, this easy-to-install option is available in your choice of brilliant chrome or gloss black finish. The traditional Bar & Shield logo adds a classic finishing touch.

Fits '96-later XL and '08-'13 XR models with front-mount horn.

69000007 Chrome. **\$29.95**

69000009 Gloss Black. **\$29.95**



I. LICENSE PLATE MOUNTING KIT WITH BUTTON HEAD SCREWS



J. LICENSE PLATE MOUNTING KIT



K. LOUD SIDE-MOUNT HORN KIT



L. LOUD HORN KIT - CHROME



L. LOUD HORN KIT - GLOSS BLACK

Model Family Fitment:

- V-ROD
- SPORTSTER
- DYNA
- SOFTAIL
- TOURING

Notice: The prices appearing in this catalog are the manufacturer's suggested retail prices. Actual retail prices may vary.

750 LIGHTING

Horns

A. WILLIE G SKULL COLLECTION HORN COVER

Styled to complement the components of the Willie G Skull Collection, this round chrome finished horn cover features a cast 3-dimensional medallion with black-filled detailing. This kit re-uses Original Equipment horn and mounting hardware.

61300622 **\$69.95**

Fits '93-later models with side-mounted horn (except VRSC™ and XG models). Not available in India or China markets.



A. WILLIE G SKULL COLLECTION HORN COVER



B. SMOOTH HORN COVER

B. SMOOTH HORN COVER

Add a custom touch to your ride. Styled to complement the Smooth Air Cleaner Cover P/N 29153-07, this compact round horn cover features a mirror chrome finish. Mounts easily to the stock horn cover bracket.

68189-07A **\$38.95**

Fits '93-later models with side-mounted horn (except VRSC and XG).

C. DARK CUSTOM LOGO HORN COVER

The famous Harley-Davidson #1 logo with a sinister twist. This horn cover is coated in gloss black and features a machined aluminum Dark Custom logo recessed in the face. The look complements other Dark Custom collection accessories, or is a perfect stand-alone addition to a completely blacked-out ride. The oval horn cover features a deep drawn steel chamber to maintain horn tone and volume. Simple to install, this kit re-uses Original Equipment horn and mounting hardware.

61300621 **\$69.95**

Fits '93-later models with side-mounted horn (except VRSC and XG models).



C. DARK CUSTOM LOGO HORN COVER



D. GLOSS BLACK HORN COVER – WATERFALL STYLE

D. GLOSS BLACK HORN COVER

This Horn Cover Kit is the perfect start in converting your powertrain to a striking blacked-out look. Manufactured from Original Equipment components, this cover is painted alongside our other components to ensure a matching black finish. Simple to install, this kit re-uses Original Equipment horn and mounting hardware.

Fits '93-later models with side-mounted horn (except VRSC and XG models).

61300623 Waterfall Style. **\$44.95**

61300452 Cowbell Style. **\$41.95**

E. WRINKLE BLACK HORN COVER

This powder coated horn cover is the perfect start in converting your powertrain to a striking blacked-out look. Manufactured from Original Equipment components, this cover is painted on the factory production line to ensure a matching wrinkle black finish.

69039-09A **\$41.95**

Fits '93-later models with side-mounted horn (except VRSC and XG).



D. GLOSS BLACK HORN COVER – COWBELL STYLE

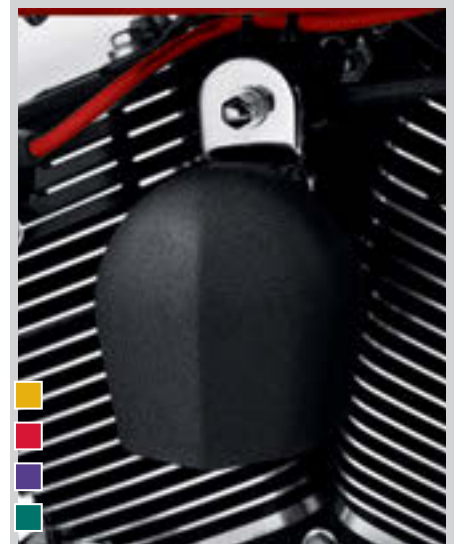

E. WRINKLE BLACK HORN COVER

Notice: The prices appearing in this catalog are the manufacturer's suggested retail prices. Actual retail prices may vary.

LIGHTING 751

Horns



F. AIR WING HORN COVER



G. BAR & SHIELD LOGO HORN COVER

F. AIR WING HORN COVER

This exclusive Air Wing chrome-plated horn cover is styled to complement the Harley-Davidson® Billet Air Cleaner Cover and is a stylish replacement for the Original Equipment horn cover. Mounts easily to stock horn cover bracket.

69167-02B **\$47.95**
Fits '93-later models with side-mounted horn (except VRSC™ and XG).

G. BAR & SHIELD LOGO HORN COVER

Complement your engine fins with this chrome-plated horn cover with engraved inserts, which feature a Bar & Shield emblem accented by a black background. Easily mounts to stock horn bracket.

69166-01B **\$47.95**
Fits '93-later models with side-mounted horn (except VRSC and XG).

H. SIDE-MOUNT HORN KIT – CHROME

Convert your stock Sportster® horn to the look of a Big Twin.

69112-95E **\$99.95**
Fits '92-later XL883, XL883C, XL883H, XL883L, XL883N, XL833R, XL1200, XL1200CX, XL1200L, XL1200N, XL1200R, XL1200V and XL1200X and '08-'13 XR models.

I. CLASSIC HORN

Early style 12V horn features nostalgic Harley-Davidson Bar & Shield logo on chrome cover. To be used as an auxiliary horn only. Do not disconnect your Original Equipment horn.

69036-88A **\$89.95**
Fits '88-'06 FXSTS models. Includes chrome mounting bracket and acorn nuts.



H. SIDE-MOUNT HORN KIT – CHROME



I. CLASSIC HORN



Model Family Fitment:

- V-ROD
- SPORTSTER
- DYNA
- SOFTAIL
- TOURING

Notice: The prices appearing in this catalog are the manufacturer's suggested retail prices. Actual retail prices may vary.

LIGHTING

WHEELS

Make a definitive style statement. Whether you're going for an old-school or new-school look, this is where you set the tone. You'll ride comfortably knowing that Harley-Davidson® wheels meet the highest standards of performance and durability.



WHEEL FINISH OPTIONS

SELECT A FINISH TO MATCH YOUR STYLE



MIRROR CHROME

Looking for the ultimate flash? Choose Mirror Chrome wheels. To achieve this rich look, our dedicated team of polishers spends hours preparing the wheel for its finish. All visible wheel surfaces are micro-polished to a glass smooth finish, and special masking is applied to prevent contamination to threads and bearing bores.

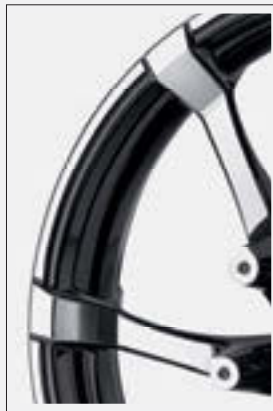

CONTRAST CHROME

Can't make up your mind? Choose Contrast Chrome wheels. We start with a hand polished wheel, and add a proprietary finish that features both gloss black paint and chrome highlights. The combination produces a stunning contrast that lightens the wheel's profile by visually thinning the spokes, rim and hub.



GLOSS BLACK

Want a sinister look? Choose Gloss Black. First, we polish all the surfaces. Then we apply the rich coating for a finish with incredible depth and shimmer. The all-black spoke and rim blend with the tire sidewall to deliver a massive profile on a blacked-out bike, but the deep gloss surface holds its own in the company of chrome.

WHEEL CARE

The road provides plenty of nasty elements that can be potentially damaging to the finish of motorcycle wheels. Harley® Wheel & Tire Cleaner safely removes brake dust and road grime from wheels, tires and whitewalls in seconds. Just wet the wheel, spray on Wheel & Tire Cleaner, work it into tight areas with a Spoke Brush, and rinse away the dirt.



WHEEL ORDERING PROCESS

STEP ONE

Select a wheel part number for your specific fitment.

STEP TWO

Select the wheel installation kit for your specific application (model, year, and front or rear). Note: If your model is not specified in the wheel fitment, a wheel installation kit will not make the wheel fit your model.

STEP THREE

Refer to the instruction sheet included in your wheel kit to determine the necessary parts required from the installation kit.

STEP FOUR

Use only Harley-Davidson specified tires. See a Harley-Davidson® dealer. Using non-specified tires can adversely affect stability, handling or braking, which could result in death or serious injury.

WHEELS 755

Tomahawk™ Custom Wheels

NEW



A. TOMAHAWK CUSTOM WHEEL – CONTRAST CHROME

A. TOMAHAWK™ CUSTOM WHEELS*

This premium cast aluminum Tomahawk™ Wheel features five spoke design for an open, airy look. Wheel comes in Contrast Chrome or Gloss Black/Black Anodized with Highlights.

19" Front

Fits '14-later Touring models (except CVO™ unless originally equipped with Tomahawk wheels).

43300641	Contrast Chrome.	\$749.95
43300642	Gloss Black/Black Anodized.	\$749.95

18" Rear

Fits '14-later Touring models (except CVO unless originally equipped with Tomahawk wheels).

40900623	Contrast Chrome.	\$749.95
40900624	Gloss Black/Black Anodized.	\$749.95

NEW



A. TOMAHAWK CUSTOM WHEEL – GLOSS BLACK/BLACK ANODIZED

*NOTE: Requires separate purchase of model-specific Wheel Installation Kit, Sprocket hardware and Brake Rotor-specific hardware. See I-sheet for details. Installation may require separate purchase of wheel size and model-specific tire.

Model Family Fitment:

- V-ROD
 SPORTSTER
 DYNA
- SOFTAIL
 TOURING

Notice: The prices appearing in this catalog are the manufacturer's suggested retail prices. Actual retail prices may vary.

756 WHEELS

Knockout™ Custom Wheel Kit

A. KNOCKOUT™ CUSTOM WHEEL KIT

The perfect one-two styling punch for your custom Road Glide® model. Knockout™ 21" front and 18" rear wheels feature a split seven-spoke design that provides an open and airy look, with the spokes blending into the rim to add visual diameter. Kit includes 21" front wheel, 18" rear wheel, and the internal front suspension components necessary to optimize fork travel and ride quality. Available in gloss black with black anodizing or contrast chrome finishes, the Knockout wheel kit provides the big wheel look you crave, without compromising touring performance and reliability.

Fits '17-later FLTRX and FLTRXS models. Does not fit models equipped with Fairing Lower, Road Glide Chizeled Handlebars or Road Glide Chizeled Lo Handlebars. Can be installed with Chopped Engine Guard P/N 49000117A. Requires separate purchase of 21" Front Fender, Front Tire P/N 43100008, Rear Tire P/N 44006-09 and model-specific Wheel Installation Kits. May require purchase of brake rotors. Models with ABS brakes require ABS recalibration. Dealer installation required. See dealer for details.

43300494 Contrast Chrome. **\$2,249.95**

43300496 Gloss Black/Anodized Black. **\$2,249.95**

Also available:

TURBINE FLOATING BRAKE ROTORS

Complete the custom look with floating brake rotors, styled to complement Original Equipment or custom wheels. Floating rotors feature a steel inner carrier that is shaped to accent the wheel, with a drilled stainless steel outer disc that is precision-riveted in place. Rotors are sold individually and include chrome installation hardware.

Fits '14-later XL, '06-'17 Dyna® (except FXDLS), '15-later Softail® (except FXSE), '08-later Touring and '09-later Trike models with Original Equipment or accessory wheel with 3.25" bolt circle rotor mount.

41500147 Gloss Black Inner. **\$249.95**

41500120 Polished. **\$249.95**

Also available:

COLOR-MATCHED 21" FRONT FENDER

Fits '17-later FLTRX and FLTRXS models equipped with Knockout Wheel Kit P/N 43300494 or 43300496.

See page 791 for all of the available Color-Matched 21" front fenders.



A. KNOCKOUT CUSTOM WHEEL – CONTRAST CHROME



A. KNOCKOUT CUSTOM WHEEL – GLOSS BLACK/ANODIZED BLACK



A. KNOCKOUT CUSTOM WHEEL KIT (SHOWN WITH TURBINE FLOATING BRAKE ROTOR AND 21" FRONT FENDER)

Notice: The prices appearing in this catalog are the manufacturer's suggested retail prices. Actual retail prices may vary.

WHEELS 757

Agitator



B. AGITATOR CUSTOM WHEELS – MIRROR CHROME

B. AGITATOR CUSTOM WHEELS*

Get ready to stir things up. The 7 forward-facing spokes of these Agitator Wheels dig deep into the soul for maximum custom impact. Spiraling from the custom hub, the flat profile spokes blend to the edge of the rim, minimizing the profile of the wheel and adding an open look that's easy to see around the matching Floating Brake Rotors. Available in your choice of finish, these wheels will set the stage for your custom direction.

19" Front

Fits '09-later Road King®, Road Glide® and Street Glide® models and '14-later Ultra Classic® and Ultra Limited models (except '12-later CVO™ unless originally equipped with Agitator wheels). Does not fit Trike models. Requires separate purchase of Agitator Floating Brake Rotors.

55071-11 Mirror Chrome. **\$749.95**

Fits '09-later Touring models (except '12-later CVO unless originally equipped with Agitator wheels). Does not fit Trike models. Requires separate purchase of Agitator Floating Brake Rotors.

55070-11 Contrast Chrome. **\$749.95**

43300442 Gloss Black. **\$614.95**

18" Rear

Fits '09-later Touring models (except '12-later CVO unless originally equipped with Agitator wheels). Does not fit Trike models.

47951-10 Mirror Chrome. **\$749.95**

40225-10 Contrast Chrome. **\$749.95**

40900459 Gloss Black. **\$614.95**

C. AGITATOR POLISHED BRAKE ROTORS

Complete the custom look with floating brake rotors, styled to complement the Agitator custom wheels. Floating rotors feature a steel inner carrier that is shaped to accent the wheel, with a polished and drilled stainless steel outer disc that is precision-riveted in place. Rotors are sold individually and include chrome installation hardware.

Front Left. Fits '09-later Touring models equipped with Agitator Custom Front Wheel.

41500007 Chrome Inner. **\$209.95**

41500053 Gloss Black Inner. **\$209.95**

Front Right. Fits '09-later Touring models equipped with Agitator Custom Front Wheel.

41500008 Chrome Inner. **\$209.95**

41500052 Gloss Black Inner. **\$209.95**



B. AGITATOR CUSTOM WHEELS – MIRROR CHROME



B. AGITATOR CUSTOM WHEELS – CONTRAST CHROME



B. AGITATOR CUSTOM WHEELS – GLOSS BLACK



C. AGITATOR POLISHED BRAKE ROTOR – GLOSS BLACK

*NOTE: Requires separate purchase of model-specific Wheel Installation Kit, Sprocket hardware and Brake Rotor-specific hardware. See I-sheet for details. Installation may require separate purchase of wheel size and model-specific tire.

Model Family Fitment:

- V-ROD
- SPORTSTER
- DYNA
- SOFTAIL
- TOURING

Notice: The prices appearing in this catalog are the manufacturer's suggested retail prices. Actual retail prices may vary.

758 WHEELS

Slicer, Machete & Enforcer

A. SLICER CUSTOM WHEELS*

Cut to the bone. The seven minimalist spokes radiate from the center hub and grasp the rim with an iron fist. The mirror chrome finish and the faceted spokes collect the light and throw it back in a brilliant display. Tested to H-D's high standards for durability and finish, this wheel will give you years of trouble-free miles.

17" Front

43300388 **\$749.95**
Fits '14-later Touring models (except CVO™ unless originally equipped with Slicer wheels). Does not fit Trike models. Requires separate purchase of (2) Polished Brake Rotors P/N 41500040.

16" Rear

40900332 **\$749.95**
Fits '14-later Touring models (except CVO unless originally equipped with Slicer wheels). Does not fit Trike models.

Shown with:

POLISHED FLOATING BRAKE ROTORS

Complete the custom look with Floating Rotors. Styled to complement the Chisel and Slicer front wheel, the inner spider features a cutout design that mirrors the wheel's 7 distinctive open spokes. Rotors are polished to a mirror shine to match your customizing direction. Rotors include chrome mounting hardware.

41500040 **\$159.95**
Fits '09-later Touring models equipped with Chisel or Slicer Custom Front Wheel.

B. MACHETE CUSTOM WHEELS*

Tempered like a fine blade, the Machete wheel holds an edge like no other. This stunning mirror chrome motion-style wheel features 3-dimensional cutting edge spokes that catch the light and shine like the full moon on a cloudless night. Tested to H-D's high standards for durability and finish, this wheel will give trouble-free miles year after year, and will keep attracting the crowd's attention.

16" Front

43300369 **\$749.95**
Fits '07-'17 FLS, FLSS, FLST, FLSTC and FLSTN models and '18-later FLDE, FLHC, FLHCS and FLSL models.

16" Rear

40900088 **\$749.95**
Fits '08-'17 FLS, FLSS, FLSTC, FLSTN, '11-'13 FXS models and '18-later FLDE, FLHC, FLHCS and FLSL models..

C. ENFORCER CUSTOM WHEELS*

Bring on the bling! Add a custom touch without changing the distinctive style of your Touring motorcycle. These 100% polished and mirror chrome plated versions of the split 5-spoke Original Equipment cast aluminum wheels broadcast stunning reflections, even while standing still. These wheels have undergone hundreds of hours of real-world testing to meet the highest standards of performance and durability.

19" Front

43300336 **\$674.95**
Fits '09-later Touring models (except '12-later CVO). Does not fit Trike models.

43300324 **\$674.95**
Fits '09-later Trike models.

16" Rear

40900346 **\$674.95**
Fits '09-later Touring models (except '12-later CVO). Does not fit Trike models.

15" Rear – Trike

40900070 **\$674.95**
Fits '09-later Trike models.



A. SLICER CUSTOM WHEELS



B. MACHETE CUSTOM WHEELS



C. ENFORCER CUSTOM WHEELS

*NOTE: Requires separate purchase of model-specific Wheel Installation Kit, Sprocket hardware and Brake Rotor-specific hardware. See I-sheet for details. Installation may require separate purchase of wheel size and model-specific tire.

Notice: The prices appearing in this catalog are the manufacturer's suggested retail prices. Actual retail prices may vary.

WHEELS 759

Impeller



D. IMPELLER CUSTOM WHEELS – CONTRAST CHROME

D. IMPELLER CUSTOM WHEELS*

Shift into a higher gear. Add a custom touch of chrome without changing the distinctive style of your Touring motorcycle. These custom finished versions of the 10-spoke Original Equipment cast aluminum wheels are the perfect marriage of tough and mechanical. Available in a 100% polished brilliant mirror chrome or contrast chrome finishes, these wheels have undergone hundreds of hours of real-world testing to meet the highest standards of performance and durability.

17" Front

Fits '09-later Touring models (except '12-later CVO™). Does not fit Trike models.

43300386	Contrast Chrome.	\$674.95
43300338	Mirror Chrome.	\$674.95

16" Rear

Fits '09-later Touring models (except '12-later CVO). Does not fit Trike models.

40900391	Contrast Chrome.	\$674.95
40900348	Mirror Chrome.	\$674.95

Shown with:

POLISHED BRAKE ROTORS – FRONT

A perfect complement to stock or custom wheels. Manufactured to Original Equipment specifications for exact fit, these rotors are meticulously polished to achieve a chrome-like appearance. Rotors are sold individually and include chrome installation hardware.

41500094		\$194.95
-----------------	--	-----------------

Fits '14-later Touring models (except FLHRC, FLHRSE and FLHTKSE) with Original Equipment, Enforcer or Impeller wheels. Also fits '09-'13 Touring models equipped with Enforcer or Impeller wheels.



D. IMPELLER CUSTOM WHEELS – MIRROR CHROME

WHEELS

*NOTE: Requires separate purchase of model-specific Wheel Installation Kit, Sprocket hardware and Brake Rotor-specific hardware. See I-sheet for details. Installation may require separate purchase of wheel size and model-specific tire.

Model Family Fitment:

■ V-ROD	■ SPORTSTER	■ DYNA
■ SOFTAIL	■ TOURING	

Notice: The prices appearing in this catalog are the manufacturer's suggested retail prices. Actual retail prices may vary.

760 WHEELS

Turbine

A. TURBINE CUSTOM WHEELS*

Bring the gleam and add some edge. These cast aluminum Turbine-style wheels feature 21 spokes which extend all the way to the edge of the rim, creating the illusion of a larger wheel diameter. The visually stunning wheels are meticulously polished and painted gloss black or chrome-plated for maximum reflective effect. All Genuine Motor Accessory wheels have been certified by Harley-Davidson to perform to our tough vehicle standards for quality and durability. Available in two unique finishes.

19" Front

Fits '14-later Touring models (except CVO™). Does not fit Trike models. Requires separate purchase of (2) Turbine Floating Brake Rotors P/N 41500120 or 41500147.

43300395	Mirror Chrome.	\$874.95
43300396	Contrast Chrome.	\$874.95
43300640	Gloss Black.	\$699.95

18" Rear

Fits '14-later Touring models (except CVO). Does not fit Trike models.

40900403	Mirror Chrome.	\$874.95
40900405	Contrast Chrome.	\$874.95
40900622	Gloss Black.	\$699.95

Shown with:

TURBINE FLOATING BRAKE ROTORS

Complete the custom look with floating brake rotors, styled to complement Original Equipment or custom wheels. Floating rotors feature a steel inner carrier that is shaped to accent the wheel, with a drilled stainless steel outer disc that is precision-riveted in place. Rotors are sold individually and include chrome mounting hardware.

Fits '14-later XL, '06-later Dyna® (except FXDLS), '15-later Softail® (except FXSE), '08-later Touring and '09-later Trike models with Original Equipment or accessory wheel with 3.25" bolt circle rotor mount.

41500120	Polished.	\$249.95
41500147	Gloss Black Inner.	\$249.95



A. TURBINE CUSTOM WHEELS – MIRROR CHROME



A. TURBINE CUSTOM WHEELS – CONTRAST CHROME



A. TURBINE CUSTOM WHEELS – GLOSS BLACK

*NOTE: Requires separate purchase of model-specific Wheel Installation Kit, Sprocket hardware and Brake Rotor-specific hardware. See I-sheet for details. Installation may require separate purchase of wheel size and model-specific tire.

Notice: The prices appearing in this catalog are the manufacturer's suggested retail prices. Actual retail prices may vary.

WHEELS 761

Turbine

B. TURBINE CUSTOM WHEELS – BREAKOUT*

Bring the gleam and add some edge. These cast aluminum Turbine-style wheels feature 21 spokes which extend all the way to the edge of the rim, creating the illusion of a larger wheel diameter. Original Equipment on the CVO™ Breakout® model, these visually stunning wheels are meticulously polished and chrome-plated for maximum reflective effect. All Genuine Motor Accessory wheels have been certified by Harley-Davidson to perform to our tough vehicle standards for quality and durability.

21" Front

Fits '13-'17 FXSB and FXSBSE models.

43300047	Mirror Chrome.	\$874.95
43300315	Contrast Chrome.	\$874.95

18" Rear

Fits '13-'17 FXSB and FXSBSE and '16-'17 FXSE models.

40900057	Mirror Chrome.	\$874.95
40900324	Contrast Chrome.	\$874.95



B. TURBINE CUSTOM WHEELS – BREAKOUT
MIRROR CHROME



B. TURBINE CUSTOM WHEELS – BREAKOUT
CONTRAST CHROME

*NOTE: Requires separate purchase of model-specific Wheel Installation Kit, Sprocket hardware and Brake Rotor-specific hardware. See I-sheet for details. Installation may require separate purchase of wheel size and model-specific tire.

Model Family Fitment:

 V-ROD	 SPORTSTER	 DYNA
 SOFTAIL	 TOURING	

Notice: The prices appearing in this catalog are the manufacturer's suggested retail prices. Actual retail prices may vary.

762 WHEELS

9-Spoke

A. 9-SPOKE CAST WHEELS*

Styled to match the popular 9-spoke traditional Touring wheel, these mirror chrome wheels utilize tooling developed specifically to give a near perfect finish without the "waves" created when polishing the Original Equipment cast wheel. The rib on the Original Equipment wheel spoke has been removed to provide a smooth uninterrupted look and countless hours of polishing result in a superior finish.

16" Front

41880-07 **\$674.95**
Fits '00-'17 FLS, FLSS, FLST, FLSTC, FLSTN, '00-'06 FLSTF, '05 FLSTFSE and '14-later FLSTNSE models.

16" Rear

40789-08 **\$674.95**
Fits '08-'17 FLS, FLSS, FLSTC, FLSTN, '14-'15 FLSTNSE and '11-'13 FXS models.

B. ABS FRONT WHEEL SPACERS

It is all in the details. Complete your total front end with these wheel spacers in mirror chrome finish. Manufactured to the Original Equipment tolerances, they deliver the exact fitment and custom shine. Chrome is Original Equipment on FLSTNSE

43300010 Chrome. **\$49.95**
Fits '11-'17 FLS, FLSS, FLSTF, FLSTC and FLSTN models with ABS brakes. FLSTC and FLSTN models require removal of Original Equipment hub cap.

C. ABS HARNESS COVER – CHROME

Dress your ABS-equipped Softail model in style. Shaped to conceal the ABS wheel speed sensor harness, this bracket mounts to the brake caliper tabs on the lower fork sliders. The mirror chrome finish complements the Original Equipment satin polished sliders or serves as the final finishing touch to a complete chrome front end.

32700002 **\$37.95**
Fits '11-'17 Softail® models (except FXCWC, FXSB and FXSBSE) equipped with ABS.



A. 9-SPOKE CAST WHEEL



B. ABS FRONT WHEEL SPACERS – CHROME



C. ABS HARNESS COVER – CHROME

*NOTE: Requires separate purchase of model-specific Wheel Installation Kit, Sprocket hardware and Brake Rotor-specific hardware. See I-sheet for details. Installation may require separate purchase of wheel size and model-specific tire.

Notice: The prices appearing in this catalog are the manufacturer's suggested retail prices. Actual retail prices may vary.

D. WHEEL INSTALLATION KITS

Once you select your wheel style, select the Wheel Installation Kit designed specifically for your motorcycle. Kit includes the bearings and spacers required for installation.



43833-07A



43848-08A



41454-08B



42400009A



43854-08A



43861-08A



41451-08C



41453-08C



43077-11A



42400003

43833-07A Front, .75" axle. **\$89.95**
Fits '00-'07 XL, '00-'03 Dyna®, '00-'05 FXDWG, '00-'06 Softail® (except FLSTS, FLSTSC and FXSTDSE) and '08-later FLSTSB models.

43848-08A Front, 1.0" axle. **\$89.95**
Fits '02-'07 VRSC™, '04-'07 Dyna (except '04-'05 FXDWG) and '00-'07 Touring models.

43851-11B Front, 25mm axle. **\$79.95**
Fits '18-later FLSL, FLDE, FLHC and FLHCS models, '08-'17 FLD, FXDF and FXDWG without ABS brakes and '07-'17 Softail models without ABS brakes (except FLSTSC, FLSTSB, FXCW, FXCWC, FXSB and FXSE).

41454-08B Front, 25mm axle, ABS. **\$79.95**
Fits '08-'17 VRSC with ABS brakes, '12-'17 FXDB, FXDC and FXDL and '16-'17 FXDLS with ABS brakes and '08-later Touring models with ABS brakes.

41455-08C Front, 25mm axle. **\$79.95**
Fits '08-'17 VRSC without ABS brakes, '08-'17 Dyna without ABS brakes (except FLD, FXDF, FXDLS and FXDWG), '16-'17 FXSE and '08-later Touring and Trike models without ABS brakes. Also fits '09-'11 Sidecar.

42400008 Front, 25mm axle. **\$79.95**
Fits '15-later XG, '08-later XL without ABS brakes and '13-'17 FXSB models without ABS brakes.

42400009A Front, 25mm axle, ABS. **\$79.95**
Fits '14-later XL models with ABS brakes and '13-'17 FXSB and FXSBSE models with ABS brakes.

42400010A Front, 25mm axle, ABS. **\$79.95**
Fits '18-later FLSL, FLDE, FLHC and FLHCS models, '12-'17 FLD, FXDF and FXDWG with ABS brakes and '11-'17 Softail models with ABS brakes (except FLSTSB and FXCWC, FXCW, FXSB and FXSBSE).

43854-08A Rear, .75" axle. **\$89.95**
Fits '00-'04 XL, '00-'05 Dyna, '00-'07 Softail and '00-'01 Touring models.

43861-08A Rear, 1.0" axle. **\$89.95**
Fits '02-'07 VRSC, '05-'07 XL, '06-'07 Dyna and '02-'07 Touring models.

43878-08B Rear, 25mm axle. **\$79.95**
Fits '08-later XL (except XL1200CX), '18-later FLSL, FLDE, FLHC and FLHCS models, '08-'17 Softail (except FXCW, FXCWC, FXSB and FXSE) and '08 Touring models without ABS brakes.

41451-08C Rear, 25mm axle. **\$79.95**
Fits '15-later XG, '16-later XL1200CX, '18-later XL1200NS and XL1200XS and '08-'17 Dyna models without ABS brakes.

41456-08C Rear, 25mm axle. **\$79.95**
Fits '08-'13 VRSC without ABS brakes, '08-'13 FXCW, FXCWC and FXSB without ABS brakes and '09-later Touring models without ABS brakes.

41453-08C Rear, 25mm axle, ABS. **\$79.95**
Fits '08-'17 VRSC with ABS brakes, '14-later XL with ABS brakes and '08-later Touring models with ABS brakes.

43077-11A Rear, 25mm axle, ABS. **\$79.95**
Fits '18-later FLSL, FLDE, FLHC and FLHCS models, '11-'17 Softail models with ABS brakes.

42400003 Rear, 25mm axle, ABS. **\$79.95**
Fits '12-'17 Dyna models with ABS brakes.

Model Family Fitment:

- V-ROD
- SPORTSTER
- DYNA
- SOFTAIL
- TOURING

Notice: The prices appearing in this catalog are the manufacturer's suggested retail prices. Actual retail prices may vary.

D. WHEEL INSTALLATION KITS

764 WHEELS

Billet Sprockets & Accessories

A. BILLET SPROCKETS

Designed to complement the wheel's styling, these custom sprockets are manufactured from 6061-T6 forged billet aircraft aluminum and precision machined to exacting Original Equipment standards. Harley-Davidson® custom sprockets are finished with a proprietary process that combines the decorative chrome with a wear-resistant surface applied to the teeth.

Fits '18-later Softail® models, '07-'17 FLS, FLSS, FLSTC, FLSTN, FLSTSC, FXCW, FXCWC, FXS, FXSB and FXSTD, '12-'17 FLSTF, FLSTFB, FLSTFBS, FLSTNSE, FLTSE, FXSBSE and FXST, and '16-'17 FXSE models. Does not fit '07-'15 Japan models. Requires separate purchase of model-specific sprocket mounting hardware.

42200066	Machete – Chrome.	\$419.95
42200067	Machete – Gloss Black.	\$419.95
42200007	Turbine.	\$419.95



A. MACHETE BILLET SPROCKET – CHROME



A. MACHETE BILLET SPROCKET – GLOSS BLACK

B. MAGNUM 5 SPROCKET COVER

Styled to match the distinctive Magnum 5 Custom Wheel. Available in mirror chrome or gloss black, this Sprocket Cover gives the appearance of having a custom sprocket at a fraction of the cost. Cover is easy to install with Original Equipment hardware or add the Chrome Hardware Kit P/N 94773-07 (sold separately) for a finished look.

Fits '07-'17 Dyna® models (except FLD).

40120-09	Chrome.	\$64.95
-----------------	---------	----------------

Fits '07-'17 Softail models (except FLSTNSE, FXCW, FXCWC, FXSB, FXSBSE and FXSE).

40121-09	Chrome.	\$64.95
-----------------	---------	----------------



A. TURBINE BILLET SPROCKET



B. MAGNUM 5 SPROCKET COVER – CHROME

C. CHROME SPROCKET COVER

This Sprocket Cover gives the appearance of having a chrome sprocket at a fraction of the cost. It matches the styling of the Original Equipment sprocket and bolts on using the stock hardware.

37757-07		\$59.95
-----------------	--	----------------

Fits '07-'17 Softail (except FLSTNSE, FXCW, FXCWC, FXSB, FXSBSE and FXSE).

91347-00		\$59.95
-----------------	--	----------------

Fits '00-'06 Softail models.



C. SPROCKET COVER – CHROME



D. REAR SPROCKET BOLT COVER KIT

These chrome-plated covers with internal spring clips hide the Original Equipment sprocket bolts for a clean, custom look. Set of 5 covers.

43876-04		\$39.95
-----------------	--	----------------

Fits '04-later XL, '93-'17 Softail, '99-later Touring models with Original Equipment 7/16" hex head sprocket mounting bolts (5/8" hex across the flats).



D. REAR SPROCKET BOLT COVER KIT



Notice: The prices appearing in this catalog are the manufacturer's suggested retail prices. Actual retail prices may vary.

WHEELS 765

Brake Rotors

E. POLISHED FLOATING BRAKE ROTORS

Complete the custom look with floating brake rotors, styled to complement Original Equipment or custom wheels. Floating rotors feature a steel inner carrier that is shaped to accent the wheel, with a polished and drilled stainless steel outer disc that is precision-riveted in place. Rotors are sold individually and include chrome installation hardware.

Front

Fits '14-later XL, '06-'17 Dyna® (except FXDLS), '15-later Softail® (except FXSE), '08-later Touring and '09-later Trike models with Original Equipment or accessory wheel with 3.25" bolt circle rotor mount.

41500107	Split 7 Spoke.	\$189.95
41500108	Split 7 Spoke, Black.	\$189.95
44944-08A	Chrome.	\$159.95
44942-08A	Teardrop – Chrome & Raw.	\$159.95
44947-08A	Vivid Black.	\$159.95
41500120	Turbine.	\$249.95
41500147	Turbine – Gloss Black.	\$249.95

Rear

Fits '00-'13 XL and XR, '00-'05 Dyna, '00-'14 Softail (except Springer™) and '00-'07 Touring models.

44360-00A	Chrome.	\$159.95
44367-00A	Teardrop.	\$159.95
44358-00A	Vivid Black.	\$159.95

Rear

Fits '00-'10 XL, '00-'17 Dyna (except FXDLS), '00-later Softail (except FXSE), and '00-'07 Touring models. Separate purchase of Brake Rotor Hub Plate P/N 43837-00 is required when installing on FXSTD original equipment 17" wheels.

41500109	Split 7 Spoke.	\$189.95
41500110	Split 7 Spoke, Black.	\$189.95
44359-00A	Chrome.	\$159.95
44368-00A	Teardrop.	\$159.95
44357-00A	Vivid Black.	\$159.95
41500069	Turbine.	\$249.95

F. AGITATOR POLISHED BRAKE ROTORS

Front Left. Fits '09-later Touring models equipped with Agitator Custom Front Wheel.

41500007	Chrome Inner.	\$209.95
41500053	Gloss Black Inner.	\$209.95

Front Right. Fits '09-later Touring models equipped with Agitator Custom Front Wheel.

41500008	Chrome Inner.	\$209.95
41500052	Gloss Black Inner.	\$209.95



E. POLISHED FLOATING BRAKE ROTORS – SPLIT 7 SPOKE



E. POLISHED FLOATING BRAKE ROTORS – SPLIT 7 SPOKE, BLACK



E. POLISHED FLOATING BRAKE ROTORS – CHROME



E. POLISHED FLOATING BRAKE ROTORS – TEARDROP



E. POLISHED FLOATING BRAKE ROTORS – VIVID BLACK



E. POLISHED FLOATING BRAKE ROTORS – TURBINE (INSET SHOWS GLOSS BLACK)



F. POLISHED AGITATOR POLISHED BRAKE ROTORS – CHROME INNER



F. POLISHED AGITATOR POLISHED BRAKE ROTORS – GLOSS BLACK INNER

Model Family Fitment:

V-ROD	SPORTSTER	DYNA
SOFTAIL	TOURING	

Notice: The prices appearing in this catalog are the manufacturer's suggested retail prices. Actual retail prices may vary.

766 WHEELS

Brake Rotors

POLISHED BRAKE ROTORS

A perfect complement to stock or custom wheels. Manufactured to Original Equipment specifications for exact fit, these rotors are meticulously polished to achieve a chrome-like appearance. Rotors are sold individually and include chrome installation hardware.

- A. Fits '09-later Touring models (except FLHRC, FLHRSE and FLHTKSE) with Enforcer or Impeller wheels.

41500094 Front.	\$194.95
------------------------	-----------------
- B. Fits '00-'13 XL and XR, '00-'05 Dyna®, '00-'14 Softail® (except Springer™) and '00-'07 Touring models.

41830-05A Front – Left Side.	\$149.95
41831-05A Front – Right Side.	\$149.95
- C. Fits '17-later FLHRXS, '14-later FLHRC and '08-'13 Touring (except '08 FLHRSE, '10-'11 FLHXSE and '09 FLTRSE) and Trike models. Fits selected accessories wheels with standard 5 hole hub-mount brake disc. Consult wheel I-sheet for details.

44950-08 Front – Left Side.	\$149.95
44959-08 Front – Right Side.	\$149.95
- D. Fits '06-'17 VRSC™ and Dyna models. Also Fits '08-later Touring and Trike models. Requires Original Equipment or accessory wheel with 6.7" bolt circle rotor mount. Does not fit Enforcer or Impeller wheels.

41500012A Front.	\$149.95
-------------------------	-----------------
- E. Fits '00-'10 XL, '00-'17 Dyna and Softail and '00-'07 Touring models. Separate purchase of Brake Rotor Hub Plate P/N 43837-00 is required when installing on FXSTD Original Equipment 17" wheels.

41832-05A Rear.	\$149.95
------------------------	-----------------



A. POLISHED BRAKE ROTOR – FRONT



A. POLISHED BRAKE ROTOR – FRONT



B. POLISHED BRAKE ROTOR – FRONT
(41831-05A SHOWN)



C. POLISHED BRAKE ROTOR – FRONT
(44950-08 SHOWN)



D. POLISHED BRAKE ROTOR – FRONT



E. POLISHED BRAKE ROTOR – REAR

Model Family Fitment:

- V-ROD
- SPORTSTER
- DYNA
- SOFTAIL
- TOURING

Notice: The prices appearing in this catalog are the manufacturer's suggested retail prices. Actual retail prices may vary.



F. DECORATIVE WHEEL WEIGHTS – BAR & SHIELD

F. DECORATIVE WHEEL WEIGHTS – BAR & SHIELD

Calibrate your wheel balance with a touch of class with these uniquely designed wheel weights. Adhesive backing for easy installation.

95615-04 .5 oz. **\$2.95**
Fits Original Equipment and accessory wheel rims.

G. BRAKE ROTOR HARDWARE KIT – CHROME

It's the details, like this chrome hardware kit, that really get your bike noticed. This hardware adds a unique chrome-plated finish to the Original Equipment or accessory floating brake rotors. Kit includes 5 chrome-plated bolts manufactured to factory specifications to ensure fit and performance.

91800029 Shoulder Bolt – Front. **\$29.95**
Fits '02-later models equipped with Open Brake Rotor P/N 44343-01, 44553-06A, 41500012A, 41500040 or 41500042.

41500095 Button Head – Front. **\$39.95**
Fits '09-later Touring models equipped with Enforcer or Impeller Wheels.

46646-05 Button Head – Front. **\$14.95**
Fits '90-later models (except VRSC™, FXSB, FXSE, '14-later Touring and Trike and models equipped with Open Brake Rotor P/N 44343-01, 44553-06A, 41500012, 41500040 or 41500042).

46647-05 Button Head – Rear. **\$14.95**
Fits '92-later models (except Trike).

H. SPROCKET HARDWARE – CHROME HEX HEAD

This kit includes highly-polished, chrome-plated, grade 8 hex-head screws with chrome-plated washers, providing an extra custom accent. The perfect addition to the chrome sprocket. Made from the same Original Equipment bolts to ensure product integrity. Also works with chrome belt sprocket covers and Original Equipment sprockets.

94773-07 **\$29.95**
Fits '07-'17 Dyna® and Softail® models.

94773-00A **\$29.95**
Fits '00-'05 Dyna and '00-'06 Softail models.

94708-98 **\$29.95**
Fits '91-later XL and '93-'99 Dyna and Softail models.

I. CHROME-PLATED ABS VALVE STEM CAPS

A special chrome touch with special graphics. Will not seize on valve stems and includes O-rings for reliable seal. Sold in pairs.

Universal fitment. Also fits suspension air valves.

1. 41144-97 Color Bar & Shield Logo. **\$9.95**

2. 41145-97 Bar & Shield Outline on Black. **\$9.95**

3. 41171-03 White Skull Logo on Black. **\$9.95**

J. CHROME-PLATED BRASS VALVE STEM CAPS

The beauty of chrome with the durability of machined brass, featuring a laser-etched Bar & Shield logo painted black. Available with a traditional, unique fluted or rugged acorn shaped cylinder. Will not seize on valve stems and includes O-rings for reliable seal. Sold in pairs.

Universal fitment. Also fits suspension air valves.

1. 41149-98 **\$14.95**
Fluted Cylinder with Bar & Shield Logo.

2. 41148-98 **\$14.95**
Acorn Nut with Bar & Shield Logo.

3. 41150-98 **\$14.95**
Acorn Nut with Grooved Cylinder with Bar & Shield Logo.



G. BRAKE ROTOR HARDWARE KIT – CHROME (91800029 SHOWN)



G. BRAKE ROTOR HARDWARE KIT – CHROME (41500095 SHOWN)



G. BRAKE ROTOR HARDWARE KIT – CHROME (46646-05 SHOWN)



H. SPROCKET HARDWARE – CHROME HEX HEAD



I. CHROME-PLATED ABS VALVE STEM CAPS



J. CHROME-PLATED BRASS VALVE STEM CAPS

Notice: The prices appearing in this catalog are the manufacturer's suggested retail prices. Actual retail prices may vary.

LUGGAGE

Sometimes a little added storage capacity is just what you need to make your ride more enjoyable. Rain gear, extra clothing and basic supplies are easy to take along when you add soft luggage to your bike.



PREMIUM TOURING LUGGAGE COLLECTION

Designed by riders, for riders. The Premium Luggage Collection features everything you ever wanted in a bag and more. Formed of superior heavy-weight ballistic nylon, these sturdy bags will maintain their shape and protect your belongings over the long haul and are tastefully styled to feel at home when carried into a nice hotel.

3M™ SCOTCHLITE™ REFLECTIVE TRIM

Retroreflection technology enhances low-light and nighttime visibility by bouncing light directly back to the source.

UV-RESISTANT FINISH

Coated to fight the sun's harshest rays and maintain the rich black color.

2-YEAR
HARLEY-DAVIDSON®
WARRANTY

DURABLE BALLISTIC NYLON CONSTRUCTION

Heavy-weight formed ballistic nylon helps bag retain its shape.

SECURE SPANDEX MOUNTING SYSTEM

Smooth band slips over the passenger backrest for a snug fit, eliminating the belts and fasteners that poke you in the back.



QUICK-RELEASE MOUNTING STRAPS

Convenient straps simplify installation and removal and provide a secure no-shift fit.



INTERLOCKING D-RINGS

Multipurpose D-Rings simplify attachment of other luggage, bungee cords or cargo nets.



OVERSIZE HANDLES

Soft-touch ergonomic handle is shaped for effortless transport to and from the bike.



GLOVE-FRIENDLY ZIPPER PULLS

Large ergonomic-contoured pulls are easy to grip for quick on-the-go access.



INTEGRATED RAIN COVER

Ripstop nylon cover is coated to shed water and features 3M™ Scotchlite™ reflective trim for added visibility.



A. TOURING LUGGAGE SYSTEM

A. TOURING LUGGAGE SYSTEM

This two-bag system features both a large Touring Bag and an exclusive compact Day Bag. The Touring Bag is ideal for a long weekend trip, but expands an additional 4.0" when you need to store a few extras. The Day Bag is perfect for the daily work commute and can be stored inside of the Touring Bag when not in use. The bags can be used together or separately to match your storage needs. The bags feature an innovative spandex mounting pocket that makes installation and removal a simple process. Just slip the smooth, low-profile band over the passenger backrest for a snug and secure fit and cinch the bag in place with the adjustable mounting straps. The spandex material reverts back to its original shape when the bag is removed for a first-class look when you are checking in to the hotel. Bag and integrated rain cover feature 3M™ Scotchlite™ reflective piping and graphics for added visibility. Luggage features a two-year Harley-Davidson® warranty. See your Dealer for details.

For additional versatility, these bags can be equipped with an optional Clip-On Rider Backrest for long haul comfort and a Premium Shoulder Strap for easy handling. Touring Bag features 3 zippered exterior pockets and 1 zippered mesh interior pocket. Day Bag features 2 exterior pockets and 1 zippered mesh interior pocket. Touring Bag Dimensions: 15.5" W x 10.0" D x 17.0" T (unexpanded); 20.0" W x 10.0" D x 17.0" T (expanded). Luggage capacity: 2400 cubic inches (unexpanded) and 3000 cubic inches (expanded). Day Bag Dimensions: 13.0" W x 10.0" D x 9.0" T. Luggage capacity: 900 cubic inches.

93300003 **\$309.95**

Installation requires a sissy bar upright, backrest pad and luggage rack (if not mounting luggage on passenger pillion). Does not fit with oversized backrest pad.

B. TOURING BAG

The Touring Bag is ideal for a long weekend trip, but expands an additional 4.0" when you need to store a few extras. The bag features large exterior pockets with glove-friendly, ergonomically contoured zipper pulls and an oversize custom handle. The innovative spandex mounting pocket makes installation and removal a simple process. Just slip the smooth, low-profile band over the passenger backrest for a snug and secure fit and cinch the bag in place with the adjustable mounting straps. The spandex material reverts back to its original shape when the bag is removed for a first-class look when you are checking in to the hotel. Bag and integrated rain cover feature 3M Scotchlite reflective piping and graphics for added visibility. Luggage features a two-year Harley-Davidson warranty. See your Dealer for details.

For additional versatility, these bags can be equipped with an optional Clip-On Rider Backrest for long haul comfort and a Premium Shoulder Strap for easy handling. Touring Bag features 3 zippered exterior pockets and 1 zippered mesh interior pocket. Dimensions: 15.5" W x 10.0" D x 17.0" T (unexpanded); 20.0" W x 10.0" D x 17.0" T (expanded). Luggage capacity: 2400 cubic inches (unexpanded) and 3000 cubic inches (expanded).

93300004 **\$229.95**

Installation requires a sissy bar upright, backrest pad and luggage rack (if not mounting luggage on passenger pillion). Does not fit with oversized backrest pad.

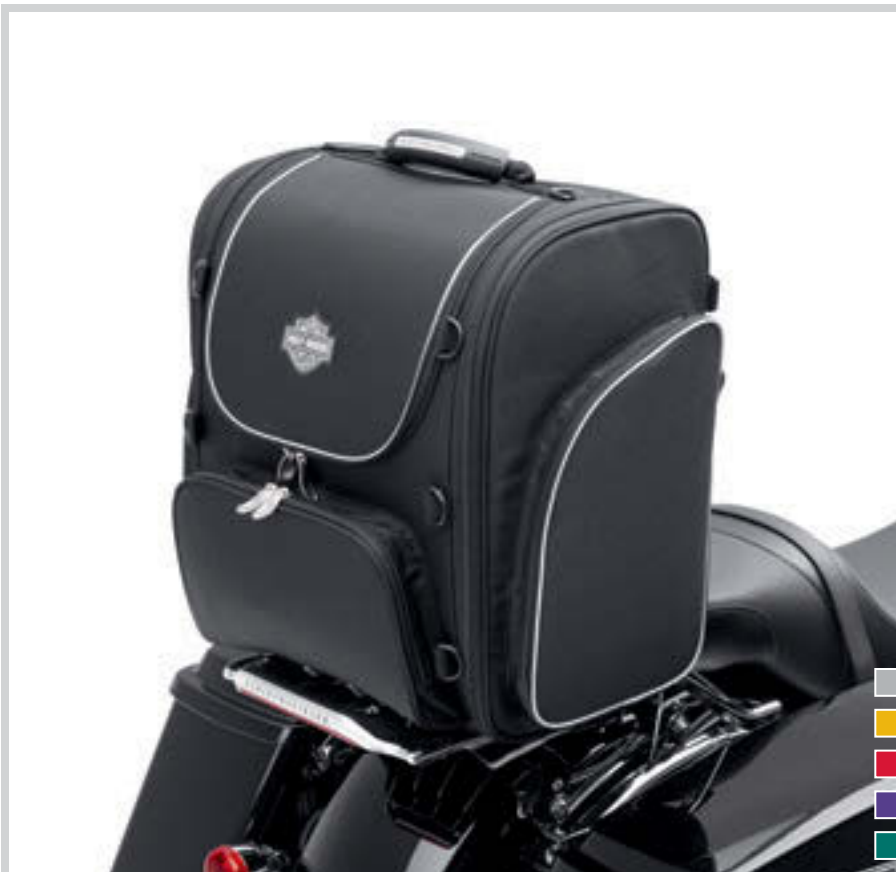

B. TOURING BAG

Model Family Fitment:

- V-ROD
- SPORTSTER
- DYNA
- SOFTAIL
- TOURING

Notice: The prices appearing in this catalog are the manufacturer's suggested retail prices. Actual retail prices may vary.

772 LUGGAGE

Touring Luggage

A. ROLLING TOURING BAG

The Rolling Touring Bag is our largest bag and is ideal for a cross-country trip. Equipped with smooth rolling sealed ball-bearing wheels and a locking push-button 2-stop extension handle, this bag is easy to move from the bike to the hotel. The Rolling Bag features large exterior pockets with glove-friendly, ergonomically contoured zipper pulls and an over-size custom handle. The innovative spandex mounting pocket makes installation and removal a simple process. Just slip the smooth, low-profile band over the passenger backrest for a snug and secure fit and cinch the bag in place with the adjustable mounting straps. The spandex material reverts back to its original shape when the bag is removed for a first-class look when you are checking in to the hotel. Bag and integrated rain cover feature 3M™ Scotchlite™ reflective piping and graphics for added visibility. Luggage features a two-year Harley-Davidson® warranty. See your Dealer for details.

For additional versatility, these bags can be equipped with an optional Clip-On Rider Backrest for long haul comfort and a Premium Shoulder Strap for easy handling. Rolling Bag features 2 zippered exterior side pockets, 1 zippered front pouch with mesh pocket and a large interior space with 1 zippered mesh pocket. Dimensions: 18.5" W x 10.5" D x 18.0" T. Luggage capacity: 3100 cubic inches.

93300008 **\$259.95**

Installation requires a sissy bar upright, backrest pad and luggage rack (if not mounting luggage on passenger pillion). Does not fit with oversized backrest pad.

B. OVERNIGHT BAG

The Overnight Bag is ideal for the shorter trip and conveniently mounts to either your Tour-Pak® luggage rack or Sissy Bar Upright. The bag features large exterior pockets with glove-friendly, ergonomically contoured zipper pulls and an over-size custom handle. The innovative spandex mounting pocket makes installation and removal a simple process. Just slip the smooth, low-profile band over the passenger backrest for a snug and secure fit and cinch the bag in place with the adjustable mounting straps. The spandex material reverts back to its original shape when the bag is removed for a first-class look when you are checking in to the hotel. Bag and integrated rain cover feature 3M Scotchlite reflective piping and graphics for added visibility. Luggage features a two-year Harley-Davidson warranty. See your Dealer for details.

For additional versatility, these bags can be equipped with an optional Clip-On Rider Backrest for long haul comfort and a Premium Shoulder Strap for easy handling. Overnight Bag features 2 zippered exterior pockets and 1 zippered mesh interior pocket. Dimensions: 16.5" W x 12.0" D x 11.0" T. Luggage capacity: 1700 cubic inches.

93300005 **\$149.95**

Installation requires a sissy bar upright, backrest pad and luggage rack (if not mounting luggage on passenger pillion). Does not fit with oversized backrest pad. Also fits models equipped with Tour-Pak, Trike or Sidecar Luggage Racks (except Mini Rack P/N 53100-96).

C. DAY BAG

The compact Day Bag is perfect for the daily work commute. The innovative spandex mounting pocket makes installation and removal a simple process. Just slip the smooth, low-profile band over the passenger backrest for a snug and secure fit and cinch the bag in place with the adjustable mounting straps. The spandex material reverts back to its original shape when the bag is removed for a first-class look when you are checking in to the hotel. Bag and integrated rain cover feature 3M Scotchlite reflective piping and graphics for added visibility. Luggage features a two-year Harley-Davidson warranty. See your Dealer for details.

For additional versatility, these bags can be equipped with a Premium Shoulder Strap for easy handling. Day Bag features 2 exterior pockets and 1 zippered mesh interior pocket. Day Bag Dimensions: 13.0" W x 10.0" D x 9.0" T. Luggage capacity: 900 cubic inches.

93300017 **\$114.95**

Installation requires a sissy bar upright, backrest pad and luggage rack (if not mounting luggage on passenger pillion). Does not fit with oversized backrest pad.



A. ROLLING TOURING BAG



B. OVERNIGHT BAG



C. DAY BAG

Notice: The prices appearing in this catalog are the manufacturer's suggested retail prices. Actual retail prices may vary.

LUGGAGE 773

Touring Luggage



D. TAIL BAG

D. TAIL BAG

This Tail Bag is the perfect addition for your daily commute or a run to the sunset. The bag rests on the passenger pillion and is secured in position with adjustable quick-release straps. The surprisingly roomy bag features 2 exterior side pockets and a large top-opening for access to the interior. The UV-resistant ballistic nylon surface covers the built-in reinforced tub that helps the bag maintain its shape – even when empty. The bag features 3M™ Scotchlite™ reflective trim for added visibility and an integrated rain cover for protection from the elements. The oversize custom handle simplifies transport to and from the motorcycle. Luggage features a two-year Harley-Davidson® warranty. See your Dealer for details.

For additional versatility, these bags can be equipped with an optional Clip-On Rider Backrest for long haul comfort and a Premium Shoulder Strap for easy handling. Tail Bag features 2 zippered exterior pockets and mesh interior pockets. Dimensions: 16.0" W x 16.0" D x 10.0" T. Luggage capacity: 1250 cubic inches.

93300069A

\$184.95

Fits passenger pillion on most models.

E. TOUR-PAK® LUGGAGE RACK BAG

The Tour-Pak® Rack Bag is perfect for one night or a quick weekend getaway and conveniently mounts to your Tour-Pak luggage rack. The built-in plastic reinforced tub and the UV-resistant, formed, 1680-denier ballistic nylon upper will maintain its sturdy shape and protect your belongings for the long haul. The bag features large exterior pockets with glove-friendly, ergonomically contoured zipper pulls and an oversize custom handle. Bag and integrated rain cover feature 3M Scotchlite reflective piping and graphics for added visibility. Luggage features a two-year Harley-Davidson warranty. See your Dealer for details.

For additional versatility, these bags can be equipped with an optional Premium Shoulder Strap for easy handling. Tour-Pak Rack Bag features 2 zippered exterior side pockets, 1 zippered top pocket and 3 zippered mesh interior pockets. Dimensions: 20.5" W x 13.0" D x 9.5" T. Luggage capacity: 2000 cubic inches.

93300006

\$209.95

Fits models equipped with Tour-Pak, Trike or Sidecar Luggage Racks (except Mini Rack P/N 53100-96).

F. COLLAPSIBLE RACK BAG

The Collapsible Rack Bag is the ideal "just in case" storage solution. Made from 1680 denier ballistic nylon, the bag folds flat to fit inside your Tour-Pak luggage when not in use. When ready, this large soft-sided bag is easy to pack and can be expanded when the need for more storage arises. The bag features an easy-access exterior pocket with glove-friendly zipper pulls. The Collapsible Rack Bag mounts to the Tour-Pak Rack with adjustable quick-release straps and includes a basic shoulder strap. Bag and integrated rain cover feature 3M Scotchlite reflective piping and graphics for added visibility. Luggage features a two-year Harley-Davidson warranty. See your Dealer for details. Dimensions: 20.0" W x 12.0" D x 12.0" T. Luggage capacity: 2700 cubic inches.

93300009

\$99.95

Fits models equipped with Tour-Pak, Trike or Sidecar Luggage Racks (except Mini Rack P/N 53100-96).



E. TOUR-PAK LUGGAGE RACK BAG



F. COLLAPSIBLE RACK BAG

Model Family Fitment:

■ V-ROD ■ SPORTSTER ■ DYNA
■ SOFTAIL ■ TOURING

Notice: The prices appearing in this catalog are the manufacturer's suggested retail prices. Actual retail prices may vary.

774 LUGGAGE

Touring Luggage

A. SISSY BAR BACKPACK

This attractive backpack is shaped to provide convenient storage on your way to work. The heavy-duty hook-and-loop flaps secure the bag to the sissy bar for one-step installation. And when you get to work, this bag features traditional backpack straps that allow you to carry your bag in hands-free comfort. The bag features plenty of smart storage spaces with glove-friendly, ergonomically contoured zipper pulls. Backpack features 2 zippered exterior pockets, 2 exterior mesh water bottle pockets, personal music device pocket with headphone port, a padded laptop compartment and a large interior space. Bag and integrated rain cover feature 3M™ Scotchlite™ reflective piping and graphics for added visibility. Luggage features a two-year Harley-Davidson® warranty. See your Dealer for details. Dimensions: 14.0" W x 13.0" D x 18.5" T. Luggage capacity: 1600 cubic inches.

93300007 \$149.95

Installation requires a sissy bar upright, backrest pad and luggage rack (if not mounting luggage on passenger pillion). Does not fit with oversized backrest pad.



A. SISSY BAR BACKPACK



B. PREMIUM RIDER BACKREST PAD

B. PREMIUM RIDER BACKREST PAD

Snap on some comfort. Designed to provide a little extra support on a long trip, this 10.0" x 7.0" Backrest Pad attaches to the Premium Touring Bag, Overnight Bag or Rolling Touring Bag with 4 simple-to-install clips. Just strap the bag to the passenger pillion, clip the pad to the Premium Luggage Bag D-rings and sit back and relax.

93300010 \$29.95

For use with Premium Luggage Collection Touring Bag, Overnight Bag and Rolling Touring Bag.

C. HDMC™ MESSENGER BAG

Take to the road in style. This bag is crafted to serve as a practical commuter and as a stylish day bag—both on and off the bike. The soft and flexible sling bag features a padded shoulder strap with a cross-chest stabilizer strap that securely holds the bag in place across your back. Or you can secure the bag to the sissy bar with the wide adjustable hook-and-loop flap and quick release tabs. The genuine canvas bag is trimmed with contrasting web straps, distressed metal buckles and a comfortable carrying handle. The exterior of the bag features a newspaper pocket, a side pocket, and bold stenciled HDMC™ graphics. Behind the wide flap, the water-resistant inner cavity features a 10" x 15" padded laptop compartment, a padded tablet pocket, and separate pockets to store cell phones, pens, glasses and more. The bag also includes a rubberized port for easy headphone connection. Dimensions: 19.0" W x 3.5" D x 13.5" T.

Installation requires a sissy bar upright, backrest pad and luggage rack (if not mounting on passenger pillion).

93300099 Black/Silver. \$169.95

93300101 Army Green. \$169.95



C. HDMC MESSENGER BAG – BLACK/SILVER



C. HDMC MESSENGER BAG – ARMY GREEN

D. PREMIUM SHOULDER STRAP

Carry your bag in comfort. This stylish Premium Shoulder Strap features a large cushioned pad that spreads the weight and eases the pressure on your shoulder. The strap clips to most Premium Luggage Collection bags and extends to 61.0" to place the bag at the ideal carrying position. The strap conveniently hides in the outside pocket of your bag and quickly snaps into place when you carry the bag into the hotel.

93300014 \$14.95

For use with Premium Luggage Collection Bags (except Sissy Bar Backpack P/N 93300007).



D. PREMIUM SHOULDER STRAP

E. AUXILIARY STRAP KIT

Ideal for use when luggage is mounted on a narrow passenger pillion, or when you need to secure multiple pieces of luggage for a long trip. This Auxiliary Strap Kit features two 34.0" adjustable straps that clip onto the luggage D-rings to provide additional mounting support.

93300015 \$14.95

For use with Premium Luggage Collection Bags.



E. AUXILIARY STRAP KIT

Notice: The prices appearing in this catalog are the manufacturer's suggested retail prices. Actual retail prices may vary.

LUGGAGE 775

Travel-Paks



F. PREMIUM TRAVEL-PAK – KING TOUR-PAK



F. PREMIUM TRAVEL-PAK – HARD SADDLEBAGS

F. PREMIUM TRAVEL-PAKS

This collection of fitted luggage provides convenient storage for your next long ride. The bags are manufactured of water resistant ballistic nylon that matches the premium luggage collection. The exterior features comfortable carrying handles, heavy-duty glove-friendly zippers, a zippered pocket and D-rings for optional carrying straps. The padded interior features a variety of convenient storage pockets and plenty of open storage. Saddlebag right-hand bag features an internal padded laptop pocket and plenty of smart storage spaces.

93300072 King Tour-Pak®. **\$99.95**
Fits '93-later Touring and Trike models equipped with King Tour-Pak luggage.

93300070 Hard Saddlebags. **\$129.95**
Fits '93-later Touring models equipped with hard saddlebags. Sold in pairs.



G. TRAVEL-PAK – KING TOUR-PAK



G. TRAVEL-PAK – HARD SADDLEBAGS

G. TRAVEL-PAKS

Simplify packing and unpacking your motorcycle. These well-constructed, water-resistant bags are designed to fit perfectly into Touring model luggage systems. The soft sides conform to the interior of the luggage to help use every available inch of space. Styled with a Bar & Shield logo, they feature heavy-duty zippers and convenient carrying handles.

53605-97 King Tour-Pak. **\$64.95**
Fits '93-later Touring and Trike models equipped with King and Ultra Tour-Pak luggage.

91885-97A Hard Saddlebags. **\$69.95**
Fits '93-later Touring models equipped with Color-Matched Hard Saddlebags and '09-'17 VRSCF models equipped with Rigid Saddlebags P/N 91172-09. Sold in pairs.

91887-98 Leather Saddlebags. (not shown) **\$64.95**
Fits '98-later FLHRC and FLHRS models. Sold in pairs.

H. SADDLEBAG TRAVEL-PAKS

Water-resistant liners make packing easy. Features inner pockets for extra storage and an embroidered Bar & Shield logo.

91959-97 **\$59.95**
Liner dimensions: 12.0" W x 10.0" T x 5.0" D.



H. SADDLEBAG TRAVEL-PAKS



I. SADDLEBAG TRAVEL-PAKS

I. SADDLEBAG TRAVEL-PAKS

Simplify packing and unpacking your motorcycle. Made from water resistant material these liners are designed to fit into the Original Equipment saddlebags on Heritage Classic models. The Travel-Pak bags feature two-way zippers for easy access, and embossed Bar & Shield patches for style.

93300107 **\$59.95**
Fits '18-later FLHC and FLHCS models with Original Equipment saddlebags. Also fits FLDE models equipped with Softail Deluxe Rigid Mount Saddlebags P/N 90201558.

93300110 **\$64.95**
Fits '18-later FLSB models.

J. SADDLEBAG COOLER

Keep beverages and snacks cold right in your saddlebag on those hot summer rides. This zippered bag is fully lined and insulated and fits the full length of your saddlebag.

90200991 **\$74.95**
Fits '93-later Touring models equipped with Color-Matched Hard Saddlebags.



J. SADDLEBAG COOLER



Model Family Fitment:

- V-ROD
- SPORTSTER
- DYNA
- SOFTAIL
- TOURING

Notice: The prices appearing in this catalog are the manufacturer's suggested retail prices. Actual retail prices may vary.

776 LUGGAGE

Small Bags

A. BLACK STANDARD LINE BAGS

Made of ultra-durable leather-like synthetic featuring a debossed H-D #1 logo, the Black Standard Line Sissy Bar and Tool Bags have a simple, black on black style that complements many styling directions and budgets. An internal reinforcement system maintains the bag's shape over time. The "MOLLE-style" system of mounting loops accommodate hook and loop straps and allow for multiple mounting locations and orientations. The bags feature either matte black enamel buckles with hidden quick-detach buckles underneath or, a hook and loop flap closure.

1. HANDLEBAR BAG

Made of ultra-durable leather-like synthetic, this Handlebar Bag is great for holding eyeglasses, toll passes and other small items you need within an arm's reach. Straight and 90 degree mounting loops make for versatile mounting to your bike. Internal capacity: 125Cl. Carrying capacity: 2.5 lbs.

93300112 \$69.95

Fits risers/handlebars without riser-mounted gauges. Does not fit 100th Anniversary logo windshields or Road Tech™ Riser Mount Radio.

2. SISSY BAR/SOLO BAG

This Sissy Bar Bag features quick-release buckles to get you in and out of the bag fast. Great for storing a light jacket, sunscreen, gloves and glasses. Bag measures 8" x 10.5" x 3.25". Internal capacity: 260Cl. Carrying capacity: 5 lbs.

93300114 \$99.95

3. TOOL BAG

This Tool Bag features decorative, black enamel buckles under which are quick-release buckles for easy access and can be mounted to various parts of the bike including the sissybar, handlebars, down tubes or a luggage rack. This Tool Bag is constructed to handle the weight of tools. The bag measures: 5.25" in diameter x 11" long. Internal capacity: 165Cl. Carrying capacity: 6 lbs.

93300113 \$69.95

B. DETACHABLE HANDBAG FOR WINDSHIELDS

Combine the on-bike storage of a windshield bag with the take-along convenience of a handbag. Constructed of leather and nylon, this durable and spacious bag features a zippered inside pocket for cell phones, cameras, wallets or sunglasses. The convenient mounting system allows easy attachment to the windshield and the quick-detach buckle lets you take it with you when you leave your bike. The purse-length leather shoulder strap and the smooth leather flap with embossed Bar & Shield logo offer the styling flexibility to complement any Harley-Davidson® motorcycle or MotorClothes® fashion design. Maximum capacity 2.5 lbs.

58402-04 \$79.95

Fits King-Size (except Nostalgic, Flame and Skull with Wings King-Size) and Compact windshields (except FXSTD, Flame and Skull with Wings). Does not fit 100th Anniversary logo windshields, models equipped with handlebar mount gauges or Road Tech™ Riser Mount Radio.

C. WINDSHIELD BAGS

Ideal for storing cell phones, sunglasses and other small items, these easy to install bags are available in a wide variety of styles to suit your customizing direction.

Fits King-Size and Compact windshields (except FXSTD, Flame and Skull with Wings). Does not fit 100th Anniversary logo windshields, models equipped with handlebar mount gauges or Road Tech Riser Mount Radio.

1. FAT BOY® WINDSHIELD BAG WITH CONCHO

56626-99 \$104.95

2. WINDSHIELD BAG FOR SOFTAIL® DELUXE MODELS

57207-05A \$114.95

3. LEATHER WITH BAR & SHIELD LOGO

58298-87 \$104.95

4. EMBOSSED BAR & SHIELD LOGO LEATHER

58308-95 \$99.95

5. ROAD KING® CLASSIC LEATHER WINDSHIELD BAG

58189-98 \$114.95



A. BLACK STANDARD LINE HANDLEBAR BAG



A. BLACK STANDARD LINE SISSY BAR/SOLO BAG



A. BLACK STANDARD LINE TOOL BAG



B. DETACHABLE HANDBAG FOR WINDSHIELDS



C. WINDSHIELD BAGS

Notice: The prices appearing in this catalog are the manufacturer's suggested retail prices. Actual retail prices may vary.

LUGGAGE 777

Windshield Bags



D. THREE-POCKET WINDSHIELD POUCH

D. THREE-POCKET WINDSHIELD POUCH

Add convenient storage space up front where you need it. This easy-to-install windshield pouch features three easily accessible storage pockets sized for cell phones, glasses and other small items. The center pouch is accented with an embossed Harley-Davidson script for a finishing touch.

58904-03 **\$109.95**

Fits King-Size (except Springer™ and Rigid-Mount King Size) and Road King® windshields (except Wind Deflector and Adjustable Height).

E. TWO-POCKET WINDSHIELD POUCH

Add convenient storage space up front where you need it. This easy-to-install windshield pouch features two easily accessible storage pockets sized for cell phones, glasses and other small items. Hook-and-loop closures allow easy one-handed opening. Both pouches are accented with an embossed Harley-Davidson logo for a finishing touch.

57203-07 **\$109.95**

Fits King-Size or Compact windshields. Does not fit FXDWG, FLSTSB or FXSTD models. Does not fit Rigid-Mount, Super Sport, Nostalgic or Flamed windshields.

F. HANDLEBAR/FORK BAGS

Constructed of durable synthetic leather with embossed H-D Eagle Wing logo. Looks great on sissy bar uprights, handlebars and front forks.

If used in front fork application, fits '93-'17 FXDWG and '84-'17 FLSTC models. Also fits '82-'89 FXR with additional purchase of Directional Relocation Kit P/N 90504-82A.

91743-87T 11-inch length. **\$34.95**

91744-87T 8-inch length. **\$29.95**

G. SOFT LEATHER HANDLEBAR/FORK BAG

Features include embroidered logos, full-length hook-and-loop closure over zipper and plush nylon pile inside lining. Features silver Harley-Davidson logo.

91773-85 **\$79.95**

If used in front fork application, fits '93-'17 FXDWG and '84-'17 FLSTC models. Also fits '82-'89 FXR with additional purchase of Directional Relocation Kit P/N 90504-82A.

H. LEATHER SISSY BAR/TOOL BAG

Heavy full-grain Latigo leather is specially tanned, oiled and waxed to withstand the elements. Identified with a custom Harley-Davidson® concho. 4.0" W x 4.0" D x 11.0" T.

91772-85A **\$99.95**

For use with FXDWG (except '10-'17 FXDWG with Original Equipment Sissy Bar) and FXSTC models only.

I. STUDED LEATHER SISSY BAR BAG

Manufactured of durable full-grain Latigo leather and decorated with bright, chrome-plated studs.

91051-94 **\$109.95**



E. TWO-POCKET WINDSHIELD POUCH



F. HANDLEBAR/FORK BAGS



G. SOFT LEATHER HANDLEBAR/FORK BAG



H. LEATHER SISSY BAR/TOOL BAG



I. STUDED LEATHER SISSY BAR BAG

Model Family Fitment:

- V-ROD
- SPORTSTER
- DYNA
- SOFTAIL
- TOURING

Notice: The prices appearing in this catalog are the manufacturer's suggested retail prices. Actual retail prices may vary.

778 LUGGAGE

Storage

A. RIDER CUP HOLDER

Shaped to blend with the contours of your Harley-Davidson® motorcycle, this unique cup holder is easy to reach without cluttering the handlebar. The attractive chrome mount securely attaches to the frame downtube and sweeps rearward to support the cup holder. The soft-touch insulated holder flexes to grip the beverage and features a perforated bottom to drain away rain water. Kit includes model-specific clamp, support rod, cup holder and all required mounting hardware.

50700002 \$59.95

Fits '00-'17 Softail® models without ABS Brakes.

50700001 \$59.95

Fits '09-later Touring and Trike models. Does not fit '14-later models equipped with Fairing Lower.



A. RIDER CUP HOLDER

B. BUNGEE CORD SOFT-HOOK EXTENSIONS

Keep your luggage firmly in place. Simply loop these soft-hook extensions around your luggage rack bar and you have a secure connection point for bungee hooks. Manufactured from a strong but flexible material, the soft-hook extensions provide convenient connection points anywhere around the luggage rack. When tightly secured around the rack bar, these soft-hook extensions will not slide, reducing the potential for luggage shift during transit.

52300140 Set of 4. \$14.95

For use on all luggage racks with rails up to .75" diameter.

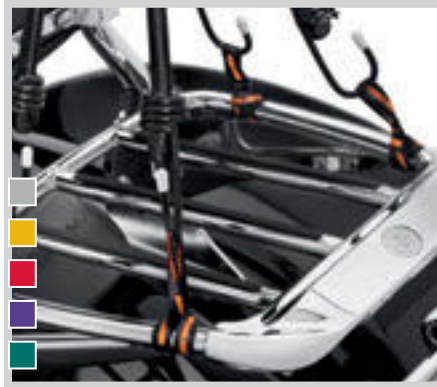

B. BUNGEE CORD SOFT-HOOK EXTENSIONS

C. BLACK CARGO NETS

These versatile nets feature vinyl-coated attaching hooks to hold your cargo securely. For helmets, small packages, etc. Works great with chrome bungee nuts.

97008-07 12.0" x 12.0" – 4 hook. \$10.95

98170-88T 15.0" x 15.0" – 6 hook. \$11.95

98169-88T 18.0" x 18.0" – 6 hook. \$12.95

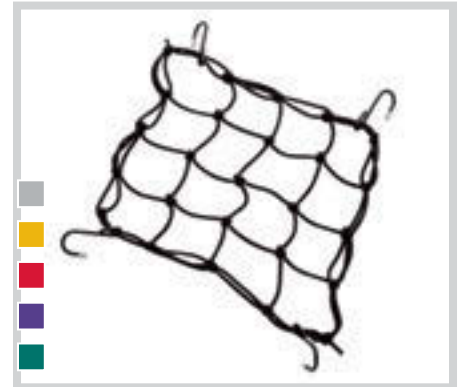

C. BLACK CARGO NET

D. BLACK BUNGEE CORDS

98196-85T 18.0" length. \$2.95

98197-85T 24.0" length. \$2.95

98198-85T 30.0" length. \$2.95

98199-85T 24.0" length – 4 hook. \$4.95

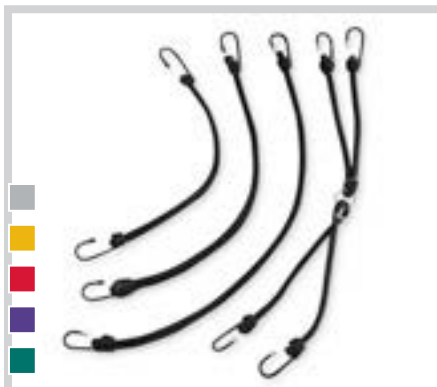

D. BLACK BUNGEE CORDS

E. CHROME BUNGEE NUTS

98185-90T .375" – 16 thread. (pair) \$8.95



E. CHROME BUNGEE NUTS

Notice: The prices appearing in this catalog are the manufacturer's suggested retail prices. Actual retail prices may vary.

LUGGAGE 779

Luggage Accessories



F. MUSIC PLAYER TANK POUCH

F. MUSIC PLAYER TANK POUCH

This portable music system pouch is designed for motorcycle use. The neoprene jacket offers hard-core protection for your portable music device, while the built-in magnets hold the pouch securely to the fuel tank. The clear play-through window permits touch-screen control and the anti-skid interior allows the pouch to accommodate players of various sizes. The clamshell design makes inserting your player into the pouch quick and easy and the double zipper allows for headphone and output cables to exit the pouch at any point on top, bottom or one side of the pouch. Simply plug in your headphones or connect your in-dash Advanced Audio Radio with an auxiliary cable or iPod® Interface and enjoy your music collection. Works well with many MP3 and other personal music players, but should not be used with hard-disk memory players. Window measurement: 2.25" W x 4.0" H.

76000193 **\$44.95**

Fits models with steel fuel tanks or airbox covers.



G. DOCUMENT HOLDER

G. DOCUMENT HOLDER

This Document Holder provides a convenient storage space under the VRSC™ hinged seat or in saddlebags. The clear zip-closure pouch attaches to the underside of the seat or to the interior of a saddlebag with convenient hook-and-loop strips and the pouch can be removed and replaced with a simple lift and pull.

94206-03 **\$10.95**

Fits '02-'17 VRSC models (except VRSCR). Also fits inside saddlebags.

H. DECORATIVE SPOTS

Make your own personal styling statement by identifying your leather jacket, cap, saddlebags, sissy bar bag, etc., with Decorative Spots that are made of rustproof, nickel-plated solid brass. Package quantity 1.

Decorative Chrome Spots

93024-88 Round .50" **\$0.25**

93025-88 Round .25" **\$0.20**

Decorative Road King® Black Jeweled Spot

93036-95 Matches FLHR models. **\$1.95**

Decorative Heritage Chrome Spot

93037-09 Matches FLSTC models. **\$1.95**

I. SADDLEBAG STRAP REPAIR KIT

Features rivets and washers required for saddlebag strap repair. Kit includes 16 rivets (4 sizes) and 16 washers.

88272-06 **\$11.95**

J. DECORATIVE CONCHOS

Stylish Harley-Davidson® conchos can customize anything, from saddlebags and seats to tank pouches and tool bags. Includes Rosette & Lacing Strap.

91877-97 Package quantity 1. **\$7.95**

K. HARLEY-DAVIDSON®/U.S.A. CUSTOM CONCHO

Conchos are polished, nickel-plated and identified with a recessed Harley-Davidson Motorcycles – U.S.A. logo in contrasting black. Attaches securely with a tie wrap. Rosette & Lacing Strap sold separately.

91857-91 Package quantity 1. **\$5.95**

Shown with:

LEATHER ROSETTE AND LACING STRAP FOR HARLEY-DAVIDSON®/U.S.A. CUSTOM CONCHO

Available in black, these leather accents can be used when attaching H-D® custom conchos.

91722-04 Package quantity 1. **\$13.95**



H. DECORATIVE SPOTS



I. SADDLEBAG STRAP REPAIR KIT



J. DECORATIVE CONCHOS



K. HARLEY-DAVIDSON®/U.S.A. CUSTOM CONCHO AND LEATHER ROSETTE AND LACING STRAP

Model Family Fitment:

- V-ROD
- SPORTSTER
- DYNA
- SOFTAIL
- TOURING

Notice: The prices appearing in this catalog are the manufacturer's suggested retail prices. Actual retail prices may vary.

780 LUGGAGE

Flags

A. PREMIUM AMERICAN FLAG KIT

Proudly display Old Glory with this Premium Flag and Mast Kit. The mast features a rich bullet shaped finial tip and a spring-mount base that easily attaches to your Luggage Rack with a chrome-plated billet clamp. The high-quality 14.0" x 11.0" nylon flag features hemmed and double-stitched edges for durability. Kit includes American flag, chrome billet mounting bracket, flag mast and all required hardware. (Flags are designed for parade use only and will not withstand high-speed use.)

61400074 **\$64.95**

Fits Air Wing Tour-Pak® Luggage Rack P/N 79179-08, 53000063 or 50300097, Premium Tour-Pak Luggage Rack P/N 53665-87, Contoured Tour-Pak Luggage Rack P/N 79148-06A and all luggage racks with .5" diameter round outer bar.

B. AMERICAN FLAG KIT

Whether showing your patriotism or your love of Harley® motorcycles, showing your colors is easier than ever with quality flag and mast kits. Flags are made with high-quality nylon for durability. Available in sissy bar mount or Tour-Pak® Luggage Carrier/Saddlebag mount. (Flags are designed for parade use only and will not withstand high-speed use.)

94616-98 Sissy bar. **\$34.95**

Fits Sissy Bars (except Mini and Short Uprights with Backrest Pads).

61400206 Tour-Pak Mount. **\$39.95**

Mounts to '14-later Touring and Tri Glide® models with Color-Matched Tour-Pak Luggage Carriers. Does not fit Leather Tour-Pak Luggage.

94626-98 Tour-Pak/Saddlebag Mount. **\$34.95**

Mounts to '14-later Touring models with Color-Matched Hard Saddlebags and mounts to '93-'13 Touring and Trike models equipped with Color-Matched Tour-Pak luggage carriers or Hard Saddlebags. Does not fit Leather Tour-Pak luggage. Also fits many car and truck roll-down windows.

94625-98 Replacement flag only. **\$19.95**



A. PREMIUM AMERICAN FLAG KIT



B. AMERICAN FLAG KIT

Notice: The prices appearing in this catalog are the manufacturer's suggested retail prices. Actual retail prices may vary.



C. WOUNDED WARRIOR PROJECT FLAG KIT

C. WOUNDED WARRIOR PROJECT® FLAG KIT

Raise the flag and salute our returning veterans who incurred service-connected injuries or illness. Complete flag and mast kit is easy to install, and features a flag manufactured with high-quality nylon for durability. Available in sissy bar mount or Tour-Pak® Luggage Carrier/Saddlebag mount versions. (Flags are designed for parade use only and will not withstand high-speed use.)

61400374 Sissy Bar. **\$34.95**
Fits Sissy Bars (except Mini and Short Uprights with Backrest Pads).

61400375 Tour-Pak Mount. **\$39.95**
Mounts to '14-later Touring and Tri Glide® models with Color-Matched Tour-Pak Luggage Carriers. Does not fit Leather Tour-Pak Luggage.

61400377 Tour-Pak/Saddlebag Mount. **\$34.95**
Mounts to '14-later Touring models with Color-Matched Hard Saddlebags and mounts to '93-'13 Touring and Trike models equipped with Color-Matched Tour-Pak Luggage carriers or Hard Saddlebags. Does not fit Leather Tour-Pak luggage. Also fits many car and truck roll-down windows.

NOTE: The Wounded Warrior Project (WWP) name and logo are trademarks of Wounded Warrior Project Inc., a tax-exempt 501 (C)(3) nonprofit organization, and are used here with their permission.

D. POW/MIA FLAG KIT

Show support for the American POW and MIA military forces with this flag and mast kit. Flags are made with high-quality nylon for durability. Available in sissy bar mount or Tour-Pak Luggage Carrier/Saddlebag mount versions. (Flags are designed for parade use only and will not withstand high-speed use.)

61400205 Tour-Pak Mount. **\$39.95**
Mounts to '14-later Touring and Tri Glide models with Color-Matched Tour-Pak Luggage Carriers. Does not fit Leather Tour-Pak Luggage.

94901-03 Tour-Pak/Saddlebag Mount. **\$34.95**
Mounts to '14-later Touring models with Color-Matched Hard Saddlebags and mounts to '93-'13 Touring and Trike models equipped with Color-Matched Tour-Pak luggage carriers or Hard Saddlebags. Does not fit Leather Tour-Pak luggage. Also fits many car and truck roll-down windows.

94902-03 Replacement POW/MIA flag only. **\$19.95**

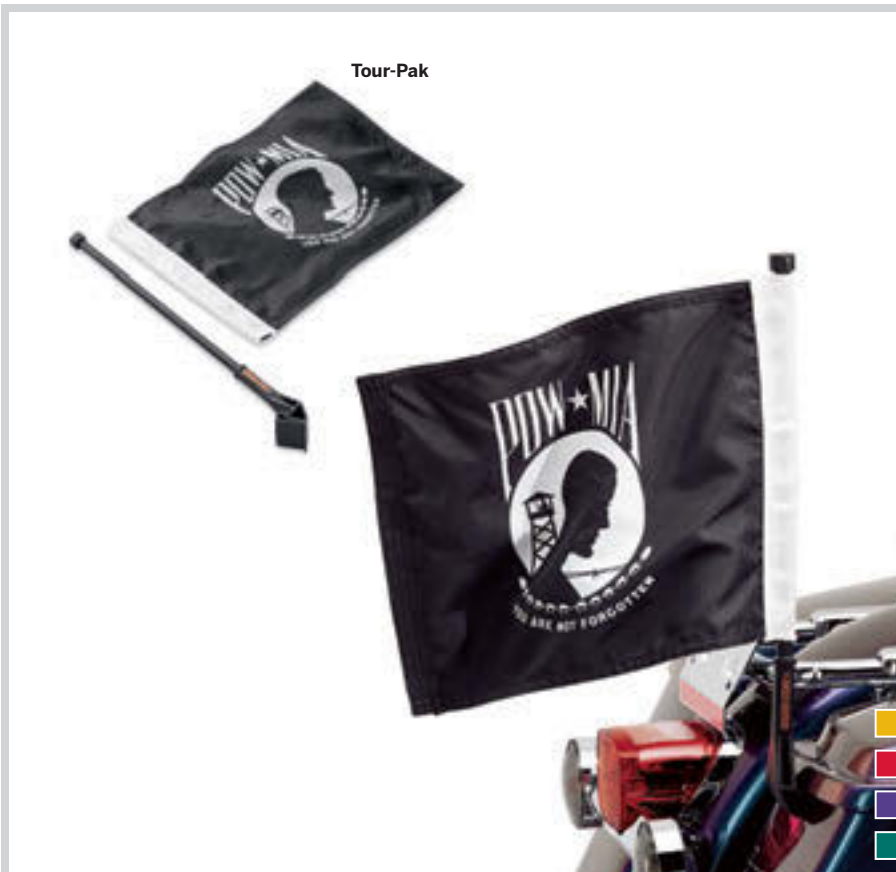

D. POW/MIA FLAG KIT

Model Family Fitment:

- V-ROD
- SPORTSTER
- DYNA
- SOFTAIL
- TOURING

Notice: The prices appearing in this catalog are the manufacturer's suggested retail prices. Actual retail prices may vary.

COLOR SHOP

The bike is a blank canvas, a surface ready to express your personality with design, color and texture. Harley-Davidson® Color Shop paint and color-matched components set the tone for the rest of the accessories and set your bike apart from the crowd.



COLOR SHOP LIMITED SERIES – GRANDSTAND

You'll be the farthest thing from a spectator when you install the Grandstand Limited Paint set on your bike. Black Denim and Fierce Orange set the stage for a hand-applied treatment resembling brushed aluminum, which is surrounded by warm red pinstripes. The lines and Harley-Davidson badging of the Grandstand Limited Paint set are a visual representation of Harley-Davidson performance. Set includes Outer Fairing, Tank, Wrapped Front Fender, Side Covers, CVO™ Rear Fender System and Stretched Saddlebags with your choice of Lid option – Standard Lids or Boom!™ Audio Speaker Lids (Boom! Audio system not included). To complete the look, this set matches perfectly with the Fierce Orange Inner Fairing (sold separately). Limited availability – only 150 serialized sets will be offered worldwide and, each set comes with a certificate of authenticity. Sets ship December 2018.



COLOR SHOP LIMITED SERIES – GRANDSTAND (SHOWN ON ROAD KING® MODEL)

Available to fit:	LIMITED: GRANDSTAND	Available to fit:	LIMITED: GRANDSTAND
Street Glide® Fits '14-later FLHX and FLHXS U.S. Domestic models only. Kit includes Domestic style CVO™ rear fender and lighting, Custom Wrapped Front Fender, Stretched Boom!™ Audio Saddlebags and Lids, Side Covers, Tank and Outer Fairing. Boom! Audio Saddlebag Speaker Kits are sold separately.	92200195EJK \$6,999.95	Road Glide® Fits '15-Later FLTRX and FLTRXS U.S. Domestic models only. Kit includes Domestic style CVO rear fender and lighting, Custom Wrapped Front Fender, Stretched Boom! Audio Saddlebags and Lids, Side Covers, Tank and Outer Fairing. Boom! Audio Saddlebag Speaker Kits are sold separately.	92200199EJK \$7,099.95
Street Glide Fits '14-later FLHX and FLHXS U.S. Domestic models only. Kit includes Domestic style CVO Rear Fender and lighting, Custom Wrapped Front Fender, Stretched Saddlebags and Lids, Side Covers, Tank and Outer Fairing.	92200193EJK \$6,999.95	Road Glide Fits '15-Later FLTRX and FLTRXS U.S. Domestic models only. Kit includes Domestic style CVO rear fender and lighting, Custom Wrapped Front Fender, Stretched Saddlebags and Lids, Side Covers, Tank and Outer Fairing.	92200197EJK \$7,099.95
Street Glide Fits '14-later FLHX and FLHXS Australia, Brazil, Europe, Japan and Mexico models. Does not fit U.S. Domestic models. Kit includes International style CVO rear fender and lighting, Custom Wrapped Front Fender, Stretched Boom! Audio Saddlebags and Lids, Side Covers, Tank and Outer Fairing. Boom! Audio Saddlebag Speaker Kits are sold separately.	92200196EJK \$6,999.95	Road Glide Fits '15-Later FLTRX and FLTRXS Australia, Brazil, Europe, Japan and Mexico models. Does not fit U.S. Domestic models. Kit includes International style CVO rear fender and lighting, Custom Wrapped Front Fender, Stretched Boom! Audio Saddlebags and Lids, Side Covers, Tank and Outer Fairing. Boom! Audio Saddlebag Speaker Kits are sold separately.	92200200EJK \$7,099.95
Street Glide Fits '14-later FLHX and FLHXS Australia, Brazil, Europe, Japan and Mexico models. Does not fit U.S. Domestic models. Kit includes International style CVO rear fender and lighting, Custom Wrapped Front Fender, Stretched Saddlebags and Lids, Side Covers, Tank and Outer Fairing.	92200194EJK \$6,999.95	Road Glide Fits '15-Later FLTRX and FLTRXS Australia, Brazil, Europe, Japan and Mexico models. Does not fit U.S. Domestic models. Kit includes International style CVO rear fender and lighting, Custom Wrapped Front Fender, Stretched Saddlebags and Lids, Side Covers, Tank and Outer Fairing.	92200198EJK \$7,099.95
Street Glide Fits '14-later FLHX and FLHXS Canada models. Does not fit U.S. Domestic models. Kit includes Canada style CVO rear fender and lighting, Custom Wrapped Front Fender, Stretched Boom! Audio Saddlebags and Lids, Side Covers, Tank and Outer Fairing. Boom! Audio Saddlebag Speaker Kits are sold separately.	92200216EJK \$6,999.95	Road King® Fits '14-later FLHR and FLHRXS U.S. Domestic models only. Kit includes Domestic style CVO rear fender and lighting, Custom Wrapped Front Fender, Stretched Saddlebags and Lids, Side Covers and Tank.	92200201EJK \$6,099.95

Notice: The prices appearing in this catalog are the manufacturer's suggested retail prices. Actual retail prices may vary.



COLOR SHOP LIMITED SERIES – GRANDSTAND (SHOWN ON STREET GLIDE® MODEL)



COLOR SHOP LIMITED SERIES – GRANDSTAND (SHOWN ON ROAD GLIDE® MODEL)

Available to fit:

**LIMITED:
GRANDSTAND**

Road King®

Fits '14-later FLHR and FLHRXS Australia, Brazil, Europe, Japan and Mexico models. Does not fit U.S. Domestic models. Kit includes International style CVO™ rear fender and lighting, Custom Wrapped Front Fender, Stretched Saddlebags and Lids, Side Covers and Tank.

**92200202EJK
\$6,099.95**

Road King

Fits '14-later FLHR and FLHRXS Canada models. Does not fit U.S. Domestic models. Kit includes Canada style CVO rear fender and lighting, Custom Wrapped Front Fender, Stretched Saddlebags and Lids, Side Covers and Tank.

**92200217EJK
\$6,099.95**

Available to fit:

**LIMITED:
GRANDSTAND**

Inner Fairing – Batwing

Fits '14-later FLHX and FLHXS models.

**57000389EJL
\$799.95**

Inner Fairing – Road Glide

Fits '15-later FLTRX and FLTRXS models. Kit includes matching Vent Duct Trim.

**57000536EJL
\$1,499.95**

Chopped Tour-Pak

Fits '14-later Road King, Road Glide and Street Glide models. Separate purchase of H-D® Detachables™ Two-Up or Solo Tour-Pak Mounting Rack and applicable Docking Hardware is required. Separate purchase of Tour-Pak® Lock Kit P/N 90300030 is required.

**53000660EJK
\$1,699.95**

COLOR SHOP LIMITED SERIES – TAGGED

Since 1903, Harley-Davidson has inspired people to follow their own road, set their own style, and find their own freedom. The Harley® riders' mantra of living life by their own rules is what the Tagged Limited Paint Set is about – stepping outside the boundaries of convention and conformity and living free-er. This distinctive paint set features a gunmetal base with a satin finish and unique, hand-ground metal grind markings that convey an attitude of edginess. Atop this canvas is intricate wildstyle graffiti art with tag lines that features graphic messaging of freedom that is reminiscent of a tough, urban landscape. This three-piece set includes front fender, rear fender and tank. Limited availability – only 150 sets will be offered worldwide and, each set comes with a certificate of authenticity. Sets ship December 2018.



COLOR SHOP LIMITED SERIES – TAGGED (SHOWN ON FAT BOB® MODEL)



COLOR SHOP LIMITED SERIES – TAGGED (SHOWN ON STREET BOB® MODEL)

Available to fit:

Fat Bob®

Fits '18-later FXFB and FXFBS models. Kit includes front fender, fuel tank and rear fender.

LIMITED: TAGGED

92200192EJN
\$2,999.95

Street Bob®

Fits '18-later FXBB models. Kit includes front fender, fuel tank and rear fender.

92200215EJN
\$2,999.95

Notice: The prices appearing in this catalog are the manufacturer's suggested retail prices. Actual retail prices may vary.

COLOR SHOP LIMITED SERIES – LA JOLLA

You're a performance junkie, a cultural rebel...you don't ride to fit in, you ride to get noticed. La Jolla Limited Paint features a vibrant chrome-yellow base with a gold pearl sheen and a vibrant orange undertone that's as bold as a California sunset. The Vivid Black slash graphics convey your performance-evangelism and a subtle counter-culture vibe. Features Harley-Davidson tank badging in a silver-charcoal hue. This four-piece set includes front fender, rear fender, tank and speed screen. Limited availability – only 100 serialized sets will be offered worldwide and, each set comes with a certificate of authenticity. Sets ship December 2018.



COLOR SHOP LIMITED SERIES – LA JOLLA (SHOWN ON BREAKOUT® MODEL)



COLOR SHOP LIMITED SERIES – LA JOLLA (SHOWN ON FXDR 114 MODEL)

Available to fit:

Breakout®

Fits '18-later FXBR and FXBRS models. Kit includes front fender, fuel tank and rear fender.

LIMITED: LA JOLLA

92200204EJM
\$3,099.95

FXDR 114

Fits '19-later FXDRS models. Kit includes front fender, speed screen, fuel tank and rear fender.

92200191EJM
\$2,999.95

Shown with:

Front Chin Spoiler – Vivid Black

Designed to cover the lower frame area and add sweeping style to the lower front end of the motorcycle, this Vivid Black Chin Spoiler is the a perfect addition for the total blacked-out look or as an accent piece to accompany custom paint. Includes all necessary mounting hardware. Fits '19-later FXDRS models.

57200222DH
\$524.95

Side Covers – Vivid Black

These left and right Side Covers instantly transform the look of your bike to smooth the visual transition from the side of the bike to the rear wheel and complement the body lines of the bike. Fits '19-later FXDRS models.

57200223DH
\$349.95

Notice: The prices appearing in this catalog are the manufacturer's suggested retail prices. Actual retail prices may vary.

COLOR-MATCHED BODYWORK

Wish you could splash more of your factory color over your bike's profile? Consider Color Shop's Accessory Bodywork. This collection of primed and color-matched components endows your Harley® motorcycle with a personality of its own. Tour-Pak® luggage, stretched saddlebags, inner fairings, spoilers and more are available in factory-matched colors for most late model Harley motorcycles.

VELOCITY RED
SUNGLO



COLOR-MATCHED SPLITSTREAM VENT TRIM AND ROAD GLIDE® HEADLAMP TRIM

COLOR-MATCHED SPLITSTREAM VENT TRIM – BATWING FAIRING

The batwing fairing is a key visual and functional element of your Touring bike, and the Splitstream vent sits front and center for all to see. Shaped to replace the Original Equipment satin black soft trim, this one-piece rigid component blends into the sweep of the outer fairing and dresses the vent in style. Available in your choice of finishes, this vent trim is the perfect complement to available windshield trim kits.

Fits '14-later Electra Glide®, Street Glide®, Ultra Limited and Tri Glide® models with batwing fairing.



COLOR-MATCHED ROAD GLIDE® HEADLAMP TRIM

This sleek one-piece headlamp surround adds a clean custom look to the nose of the Road Glide® model. The easy-to-install Headlamp Trim hugs the dual headlamps and covers the matte black factory bezel for a menacing aerodynamic appearance. The swept back look and the knife-edge side strakes emphasize the streamlined shape of the fairing without impeding air flow to the vents or obstructing headlamp light patterns. Available in your choice of finish, the self-adhesive Headlamp Trim can be installed without removing the headlamp or fairing.

Fits '15-later Road Glide models.



*NOTE: This product is a Paint to Order accessory. Please allow for an average of 5 weeks delivery for this item.



Solid Color

	Splitstream Vent Trim		Headlamp Trim	
	P/N	Price	P/N	Price
Chrome	61300505	\$74.95	61400411	\$99.95
Barracuda Silver	61300461EKR	\$99.95	—	—
Billiard Blue	61300461EKP	\$99.95	61400412EKP	\$119.95
Black Denim	—	—	61400412BYM	\$124.95
Black Earth	—	—	61400412EGS	\$155.95
Black Fuse	—	—	61400412ELL	\$139.95
Black Tempest	61300461EEV	\$99.95	—	—
Blue Max	61300461ELE	\$119.95	61400412ELE	\$139.95
Bonneville Salt Denim	61300461EFW	\$99.95	—	—
Bonneville Salt Pearl	—	—	61400412EFU	\$124.95
Chameleon Flake (HCC)	61300461EEP	\$119.95	61400412EEP	\$144.95
Crushed Ice Pearl	61300461DZS	\$99.95	—	—
Electric Blue	61300461EFM	\$99.95	61400412EFM	\$124.95
Gunship Gray (CVO)	—	—	61400412EGZ	\$155.95
Hot Rod Red Flake (HCC)	61300461ECN	\$119.95	—	—
Industrial Gray	—	—	61400412EEZ	\$124.95
Industrial Gray Denim	61300461EFC	\$99.95	61400412EFC	\$119.95
Kinetic Green	61300461ELD	\$119.95	61400412ELD	\$139.95
Laguna Orange	61300461ECL	\$119.95	—	—
Legend Blue Denim	61300461EEL	\$119.95	—	—
Legend Blue	61300461EEN	\$119.95	—	—
Lightning Silver	—	—	61400412EHY	\$149.95
Mako Shark	—	—	61400412EJH	\$149.95
Midnight Blue	61300461EKA	\$99.95	61400412EKA	\$119.95
Olive Gold	61300461DZW	\$99.95	—	—
Orange Lava (CVO)	—	—	61400412EGX	\$155.95
Red Pepper	—	—	61400412EHV	\$149.95
Scorched Orange	61300461ELG	\$119.95	—	—
Shattered Flake (HCC)	61300461EEO	\$119.95	61400412EEO	\$144.95
Silver Flux	61300461ELI	\$119.95	—	—
Silver Fortune	61300461EFP	\$99.95	61400412EFP	\$124.95
Sumatra Brown	—	—	61400412EFD	\$124.95
Superior Blue	61300461DWC	\$99.95	—	—
Twisted Cherry	61300461EFH	\$99.95	61400412EFH	\$124.95
Velocity Red Sunglo	61300461DZT	\$99.95	—	—
Vivid Black	61300461DH	\$74.95	61400412DH	\$99.95
Wicked Red	61300461EFF	\$99.95	61400412EFF	\$124.95
Wicked Red Denim	61300461EKG	\$99.95	61400412EKG	\$119.95

790 COLOR SHOP

Custom Body Components

A. CUSTOM WRAPPED FRONT FENDER

Give your bike a big hug. This all-steel fender is shaped to show off the full profile of your 19" front wheel. The apron-less fender wraps almost 180 degrees around the front tire for a clean, custom appearance, and the low profile cutaway design exposes the wheel from hub to rim for maximum visual impact. Designed for mistake-proof installation, the fender is pre-drilled to fit Original Equipment fender mounting bosses, and does not require additional fender spacers or install kits. Available in Color-Matched, Vivid Black or primed and ready-to-paint finish.

Fits '14-later Touring models equipped with 17", 18" or 19" wheel and tire combination. Does not fit with Fender Tip Assembly P/N 59600003 or 59600006. Does not fit Trike models.

58900196BEO	Primed.	\$449.95
58900196BYM	Black Denim.	\$699.95
58900196EKR	Barracuda Silver.	\$699.95
58900196EKP	Billiard Blue.	\$699.95
58900421ELE	Blue Max.	\$749.95
58900196EEV	Black Tempest.	\$699.95
58900196EFW	Bonneville Salt Denim.	\$699.95
58900196EFU	Bonneville Salt Pearl.	\$699.95
58900196EEP	Chameleon Flake (HCC).	\$849.95
58900196DZN	Charcoal Denim.	\$699.95
58900196DZS	Crushed Ice Pearl.	\$699.95
58900196EFM	Electric Blue.	\$699.95
58900196ECN	Hot Rod Red Flake (HCC).	\$849.95
58900196EEZ	Industrial Gray.	\$699.95
58900196EFC	Industrial Gray Denim.	\$699.95
58900421ELD	Kinetic Green.	\$749.95
58900196ECL	Laguna Orange.	\$749.95
58900196EEL	Legend Blue Denim.	\$749.95
58900363EEM	Legend Blue/Vivid Black.	\$749.95
58900196EKA	Midnight Blue.	\$699.95
58900196DZW	Olive Gold.	\$699.95
58900403ELF	Scorched Orange/Black Denim.	\$749.95
58900196EEO	Shattered Flake (HCC).	\$849.95
58900403ELH	Silver Flux/Black Fuse.	\$749.95
58900196EFP	Silver Fortune.	\$699.95
58900196EFD	Sumatra Brown.	\$699.95
58900196DWC	Superior Blue.	\$699.95
58900196EFH	Twisted Cherry.	\$699.95
58900196DZT	Velocity Red Sunglo.	\$699.95
58900196DH	Vivid Black.	\$699.95
58900196EFF	Wicked Red.	\$699.95
58900196EKG	Wicked Red Denim.	\$699.95

CVO™ Color

58900196EJD	Black Forest.	\$699.95
58900360EJC	Black Forest & Wineberry.	\$849.95
58900360EJB	Charred Steel & Lightning Silver.	\$849.95
58900360EGW	Dark Alloy & Black Denim.	\$849.95
58900196EGZ	Gunship Gray.	\$699.95
58900360EGY	Orange Lava & Black Denim.	\$849.95



A. CUSTOM WRAPPED FRONT FENDER – VIVID BLACK



A. CUSTOM WRAPPED FRONT FENDER – HOT ROD RED FLAKE

Notice: The prices appearing in this catalog are the manufacturer's suggested retail prices. Actual retail prices may vary.



B. COLOR-MATCHED 21" FRONT FENDER

B. COLOR-MATCHED 21" FRONT FENDER

Required for use with the Knockout Custom Wheel Kit.

Fits '17-later FLTRX and FLTRXS models equipped with Knockout Wheel Kit P/N 43300494 or 43300496.

58900319	Primed.	\$399.95
58900336EKP	Billiard Blue.	\$549.95
58900336BYM	Black Denim.	\$449.95
58900423ELE	Blue Max.	\$599.95
58900336EFU	Bonneville Salt Pearl.	\$549.95
58900336EEP	Chameleon Flake (HCC).	\$699.95
58900336ECN	Hot Rod Red Flake (HCC).	\$699.95
58900336EEZ	Industrial Gray.	\$549.95
58900336EFC	Industrial Gray Denim.	\$549.95
58900423ELD	Kinetic Green.	\$599.95
58900400ELF	Scorched Orange/Black Denim.	\$599.95
58900336EEO	Shattered Flake (HCC).	\$699.95
58900400ELH	Silver Flux/Black Fuse.	\$599.95
58900336EFD	Sumatra Brown.	\$549.95
58900336EFH	Twisted Cherry.	\$549.95
58900336DGH	Vivid Black.	\$549.95
58900336EFF	Wicked Red.	\$549.95
58900336EKG	Wicked Red Denim.	\$549.95

C. ROAD GLIDE® FAIRING SPOILER

Add a custom touch to your motorcycle with a Color-Matched Road Glide® Fairing Spoiler. Designed to replace the Original Equipment Road Glide Fairing Spoiler.

Fits '17-later FLTRX and FLTRXS models. Requires separate purchase of Chopped Engine Guard P/N 49000117A.

57001042EKP	Billiard Blue.	\$399.95
57001042ELE	Blue Max.	\$449.95
57001042EEZ	Industrial Gray.	\$399.95
57001042EFC	Industrial Gray Denim.	\$399.95
57001042ELD	Kinetic Green.	\$449.95
57001042ELI	Silver Flux.	\$479.95
57001042ELG	Scorched Orange.	\$479.95
57001042EFH	Twisted Cherry.	\$399.95
57001042DGH	Vivid Black.	\$399.95
57001042EFF	Wicked Red.	\$399.95
57001042EKG	Wicked Red Denim.	\$399.95



C. ROAD GLIDE FAIRING SPOILER

Notice: The prices appearing in this catalog are the manufacturer's suggested retail prices. Actual retail prices may vary.

792 COLOR SHOP

Custom Body Components

COLOR-MATCHED MID-FRAME AIR DEFLECTORS & VENTED FAIRING LOWER KITS

COLOR-MATCHED MID-FRAME AIR DEFLECTORS

Improve rider comfort during the summer riding season. Designed for severe duty and extreme temperature applications, these color-matched deflectors attach to the frame and surround the top of the rear cylinder head. The scoop shape captures the moving air and uses the flow to direct the heat down and away from the rider to improve comfort. Kit includes all required mounting hardware.

Fits '17-later Touring and Trike models equipped with CoolFlow™ Fan P/N 26800120, 26800121 and 26800128.

Fits '09-later Touring and Trike models. Not compatible with '17-later models equipped with CoolFlow Fan P/N 26800120, 26800121 and 26800128.

COLOR-MATCHED VENTED FAIRING LOWER KIT*

Original Equipment on many Touring models, these Fairing Lower feature a venting system that allows you to adjust the amount of air that circulates across the engine. Open the vent to direct additional cooling air and close the vents for protection from the elements. The ratcheting friction lock pivot allows you to easily set the position. The complete kit includes left and right Fairing Lower, convenient glove box and lid and all necessary mounting hardware. NOTE: Fairing Lower Kits are painted in a single color and do not feature pinstriping.

Fits '14-later Air-Cooled Touring and Trike models. Does not fit Twin-Cooled™ models or '18 FLTRXSE. Freewheeler® models require separate purchase of Engine Guard P/N 49184-09A or 49050-09A and Steering Stabilizer Bracket P/N 83865-09. Does not fit with Mustache Engine Guards, Chopped Engine Guards or Knockout Wheel Kit P/N 43300494 or 43300496.



Vented Fairing Lower – Fits '14-later Air-Cooled Touring and Trike models

Solid Color	Fits models – with CoolFlow™ Fan		Fits models – without CoolFlow Fan		Vented Fairing Lower – Fits '14-later Air-Cooled Touring and Trike models	
	P/N	Price	P/N	Price	P/N	Price
Primed/Paintable	—	—	—	—	57100258	\$454.95
Barracuda Silver	57300226EKR	\$139.95	57300225EKR	\$139.95	57100257EKR	\$699.95
Billiard Blue	57300226EKP	\$139.95	57300225EKP	\$139.95	57100257EKP	\$699.95
Black Tempest	—	—	—	—	57100257EEV	\$704.95
Blue Max	57300226ELE	\$149.95	57300225ELE	\$149.95	57100257ELE	\$719.95
Bonneville Salt Denim	57300226EFW	\$139.95	57300225EFW	\$139.95	57100257EFW	\$704.95
Bonneville Salt Pearl	57300226EFU	\$139.95	57300225EFU	\$139.95	57100257EFU	\$704.95
Chameleon Flake	—	—	—	—	57100257EEP	\$724.95
Charcoal Denim	—	—	—	—	57100257DZN	\$704.95
Electric Blue	—	—	—	—	57100257EFM	\$704.95
Hot Rod Red Flake	—	—	—	—	57100257ECN	\$724.95
Industrial Gray	57300226EEZ	\$139.95	57300225EEZ	\$139.95	57100257EEZ	\$699.95
Industrial Gray Denim	57300226EFC	\$139.95	57300225EFC	\$139.95	57100257EFC	\$704.95
Kinetic Green	57300226ELD	\$149.95	57300225ELD	\$149.95	57100257ELD	\$719.95
Laguna Orange	—	—	—	—	57100257ECL	\$704.95
Legend Blue	—	—	—	—	57100257EEN	\$724.95
Legend Blue Denim	—	—	—	—	57100257EEL	\$724.95
Midnight Blue	57300226EKA	\$139.95	57300225EKA	\$139.95	57100257EKA	\$699.95
Olive Gold	—	—	—	—	57100257DZW	\$704.95
Scorched Orange	57300226ELG	\$149.95	57300225ELG	\$149.95	57100257ELG	\$719.95
Shattered Flake	—	—	—	—	57100257EEO	\$724.95
Silver Fortune	—	—	—	—	57100257EFP	\$704.95
Sumatra Brown	—	—	—	—	57100257EFD	\$704.95
Superior Blue	—	—	—	—	57100257DWC	\$704.95
Silver Flux	57300226ELI	\$149.95	57300225ELI	\$149.95	57100257ELI	\$719.95
Twisted Cherry	57300226EFH	\$139.95	57300225EFH	\$139.95	57100257EFH	\$704.95
Velocity Red Sunglo	—	—	—	—	57100257DZT	\$704.95
Vivid Black	57300226DH	\$139.95	57300225DH	\$139.95	57100257DH	\$704.95
Wicked Red	57300226EFF	\$139.95	57300225EFF	\$139.95	57100257EFF	\$704.95
Wicked Red Denim	57300226EKG	\$139.95	57300225EKG	\$139.95	57100257EKG	\$699.95

CVO™ Primary Color	P/N	Price	P/N	Price
Black Forest	57300226EJD	\$159.95	57300225EJD	\$159.95
Blue Tide	57300226EJJ	\$159.95	57300225EJJ	\$159.95
Charred Steel	57300226EJA	\$159.95	57300225EJA	\$159.95
Lightning Silver	57300226EHY	\$159.95	57300225EHY	\$159.95
Magnetic Gray	57300226EHU	\$159.95	57300225EHU	\$159.95
Wineberry	57300226EHW	\$159.95	57300225EHW	\$159.95

*NOTE: This product is a Paint to Order accessory. Please allow for an average of 5 weeks delivery for this item.

Notice: The prices appearing in this catalog are the manufacturer's suggested retail prices. Actual retail prices may vary.

COLOR SHOP 793

Custom Body Components



C. CUSTOM STRETCHED SIDE COVERS – VIVID BLACK

C. CUSTOM STRETCHED SIDE COVERS

Add a long, lean look to the profile of your Touring bike. These Stretched Side Covers are sculpted to smooth the visual transition from the side of the bike to the front of the saddlebag, and trade the traditional stepped look for a rearward flowing design. Shaped to flare out and down the saddlebag face, the sleek side covers complement the body lines and eliminate the saddlebag guard clearance notch at the lower corner for a seamless flow. And unlike some aftermarket designs, these side covers fit without significantly compromising the available passenger foot space. The one-piece covers are a snap-in replacement for the Original Equipment covers, and require no bonding or modification for installation. Available in Color-Matched, Vivid Black or primed and ready-to-paint finish.

Fits '14-later Touring models. Does not fit with Auxiliary Power Port P/N 69201099.

61300671BEO	Primed.	\$449.95
61300671EKR	Barracuda Silver.	\$649.95
61300671EKP	Billiard Blue.	\$649.95
61300671BYM	Black Denim.	\$649.95
61300671EEV	Black Tempest.	\$649.95
61301098ELE	Blue Max.	\$699.95
61300671EFW	Bonneville Salt Denim.	\$649.95
61300671EFU	Bonneville Salt Pearl.	\$649.95
61300671EEP	Chameleon Flake (HCC).	\$799.95
61300671DZN	Charcoal Denim.	\$649.95
61300671DZS	Crushed Ice Pearl.	\$649.95
61300671EFM	Electric Blue.	\$649.95
61300671ECN	Hot Rod Red Flake (HCC).	\$799.95
61300671EEZ	Industrial Gray.	\$649.95
61300671EFC	Industrial Gray Denim.	\$649.95
61301098ELD	Kinetic Green.	\$699.95
61300671ECL	Laguna Orange.	\$699.95
61300671EEL	Legend Blue Denim.	\$699.95
61300960EEM	Legend Blue/Vivid Black.	\$699.95
61300671EKA	Midnight Blue.	\$649.95
61300671DZW	Olive Gold.	\$649.95
61300923ELF	Scorched Orange/Black Denim.	\$699.95
61300671EEO	Shattered Flake (HCC).	\$799.95
61300923ELH	Silver Flux/Black Fuse.	\$699.95
61300671EFP	Silver Fortune.	\$649.95
61300671EFD	Sumatra Brown.	\$649.95
61300671DWC	Superior Blue.	\$649.95
61300671EFH	Twisted Cherry.	\$649.95
61300671DZT	Velocity Red Sunglo.	\$649.95
61300671DH	Vivid Black.	\$649.95
61300671EFF	Wicked Red.	\$649.95
61300671EKG	Wicked Red Denim.	\$649.95

CVO™ Color

61300671EJD	Black Forest.	\$799.95
61300923EJC	Black Forest & Wineberry.	\$899.95
61300923EJE	Charred Steel.	\$899.95
61300923EJB	Charred Steel & Lightning Silver.	\$899.95
61300923EJF	Magnetic Gray.	\$899.95
61300923EJG	Mako Shark Fade.	\$899.95



C. CUSTOM STRETCHED SIDE COVERS – HOT ROD RED FLAKE

Notice: The prices appearing in this catalog are the manufacturer's suggested retail prices. Actual retail prices may vary.

794 COLOR SHOP

Color-Matched Accessories

COLOR-MATCHED STRETCHED SADDLEBAG BOTTOMS

COLOR-MATCHED STRETCHED SADDLEBAG BOTTOMS*

Add the long low "slammed" look to your Touring bike without compromising the suspension travel and ride height. These Stretched Saddlebag Bottoms wrap around the exhaust to add visual length to the bike and hide the muffler bracket and hanger from view. Stretched Bottoms are predrilled to accept your existing saddlebag lids and latches. Simply attach the extended saddlebag bottom to your saddlebag lids with the included hardware and install on the bike like the original bags.

Available to fit:

Fits '14-later Touring models with Color-Matched Hard Saddlebags.

*NOTE: This product is a Paint to Order accessory. Please allow for an average of 5 weeks delivery for this item.



Stretched Saddlebag Bottoms Fits '14-later models

Solid Color	Inner/Outer Pinstripe	P/N	Price
Primed/Paintable	—	90201107	\$1,099.95
Barracuda Silver	—	90201078EKR	\$1,299.95
Black Denim	—	90201078BYM	\$1,299.95
Black Gold Flake (HCC)	—	90201078EAI	\$1,399.95
Black Tempest	—	90201078EEV	\$1,299.95
Blue Max	—	90201953ELE	\$1,399.95
Chameleon Flake (HCC)	—	90201078EEP	\$1,399.95
Charcoal Denim	—	90201078DZN	\$1,299.95
Cosmic Blue Pearl	—	90201385DZZ	\$1,399.95
Crushed Ice Pearl	—	90201078DZS	\$1,299.95
Electric Blue	—	90201078EFM	\$1,299.95
Gold Flake (HCC)	—	90201078DWG	\$1,399.95
Hot Rod Red Flake (HCC)	—	90201078ECN	\$1,399.95
Industrial Gray	—	90201078EEZ	\$1,299.95
Industrial Gray Denim	—	90201078EFC	\$1,299.95
Kinetic Green	—	90201953ELD	\$1,399.95
Laguna Orange	—	90201504ECL	\$1,399.95
Midnight Blue	—	90201078EKA	\$1,299.95
Olive Gold	—	90201078DZW	\$1,299.95
Shattered Flake (HCC)	—	90201078EEO	\$1,399.95
Silver Fortune	—	90201078EFP	\$1,299.95
Sumatra Brown	—	90201078EFD	\$1,299.95
Superior Blue	—	90201078DWC	\$1,299.95
Twisted Cherry	—	90201078EFH	\$1,299.95
Velocity Red Sunglo	—	90201078DZT	\$1,299.95
Vivid Black	—	90201078DH	\$1,299.95
Billet Silver (FLHR)	Burgundy/Charcoal Metallic	90201093DZR	\$1,349.95
Black Quartz (FLHXS/FLTRXS)	Pale Gold	90201088EAK	\$1,349.95
Charcoal Denim (FLHXS)	Charcoal Metallic	90201088DZO	\$1,349.95
Velocity Red Sunglo (FLHXS/FLTRXS)	Medium Red	90201088EAM	\$1,349.95
Velocity Red Sunglo (FLHR)	Medium Red/Pale Gold	90201093DZU	\$1,349.95
Vivid Black	Medium Silver/Medium Silver	90201093BHJ	\$1,349.95
Wicked Red	Twisted Cherry	90201093EGG	\$1,399.95

CVO™ Colors

Panel Inner/Outer Pinstripe

Auburn Sunglo	Black Hole/Rich Bourbon	90201905EHT	\$1,599.95
Crushed Ice Pearl/Frosted Teal Pearl (FLHR)	Gray/Teal	90201093EAE	\$1,399.95
Electric Blue/Silver Fortune	Blue/Warm Silver	90201093EGA	\$1,399.95
Legend Blue/Vivid Black	Blue/Medium Silver/Blue	90201093EEM	\$1,399.95
Magnetic Gray	Red Pepper/Wineberry	90201905EHX	\$1,599.95
Magnetic Gray Fade	—	90201905EHZ	\$1,599.95
Olive Gold/Black Tempest	Olive Tan/Roman Gold	90201093EGE	\$1,399.95
Purple Fire/Blackberry Smoke (FLHR)	Proper Purple/Charcoal Metallic	90201093EAG	\$1,399.95
Silver Fortune/Sumatra Brown	Burgundy/Warm Silver	90201093EGC	\$1,399.95

Notice: The prices appearing in this catalog are the manufacturer's suggested retail prices. Actual retail prices may vary.

BOOM!™ AUDIO SADDLEBAG SPEAKER LIDS & FAIRING LOWER SPEAKER HOUSINGS

SADDLEBAG AND FAIRING LOWER SPEAKER HOUSINGS*

Custom Color-Matched covers are shaped to accommodate Boom!™ Audio Saddlebag Lid and Fairing Lower Speakers. Speaker openings are formed to angle the speakers and direct the sound forward toward the rider and passenger. Installation reuses Original Equipment hinges, locks and mounting hardware.

SADDLEBAG LID SPEAKERS – Available to fit:

Fits '14-later Touring (except Road King®) models equipped with Boom!™ Audio Saddlebag Speaker Kit P/N 76000489 or 76000319.

FAIRING LOWER SPEAKER BOXES – Available to fit:

Fits '14-later Touring (except Road King and CVO™) models equipped with vented fairing lowers and Boom! Audio Fairing Lower Speaker Kit P/N 76000487 or 76000353. Does not fit models with Twin-Cooled™ engines.



*NOTE: This product is a Paint to Order accessory. Please allow for an average of 5 weeks delivery for this item.

	Boom! Saddlebag Lid–Left Fits '14-later models		Boom! Saddlebag Lid–Right Fits '14-later models		Boom! Fairing Lower Speaker Box Fits '14-later models	
Solid Color	P/N	Price	P/N	Price	P/N	Price
Primed/Paintable	90201109	\$199.95	90201108	\$199.95	57100233	\$184.95
Barracuda Silver	90200827EKR	\$309.95	90200826EKR	\$309.95	76000497EKR	\$279.95
Billet Silver	90200827DZP	\$309.95	90200826DZP	\$309.95	—	—
Billiard Blue	90200827EKP	\$309.95	90200826EKP	\$309.95	76000497EKP	\$279.95
Black Denim	90200827BYM	\$309.95	90200826BYM	\$309.95	76000497BYM	\$284.95
Black Gold Flake (HCC)	90201397EAI	\$349.95	90201401EAI	\$349.95	76000497EAI	\$299.95
Black Quartz	90200827DWE	\$309.95	90200826DWE	\$309.95	—	—
Black Tempest	90200827EEV	\$309.95	90200826EEV	\$309.95	76000497EEV	\$284.95
Blue Max	90200827ELE	\$339.95	90200826ELE	\$339.95	76000497ELE	\$299.95
Bonneville Salt Denim	90200827EFW	\$309.95	90200826EFW	\$309.95	76000497EFW	\$284.95
Bonneville Salt Pearl	90200827EFU	\$309.95	90200826EFU	\$309.95	76000497EFU	\$284.95
Chameleon Flake (HCC)	90200827EEP	\$349.95	90200826EEP	\$349.95	76000497EEP	\$304.95
Charcoal Denim	90200827DZN	\$309.95	90200826DZN	\$309.95	76000497DZN	\$284.95
Cosmic Blue Pearl	90200827DZZ	\$339.95	90200826DZZ	\$339.95	—	—
Crushed Ice Pearl	90200827DZS	\$309.95	90200826DZS	\$309.95	76000497DZS	\$284.95
Electric Blue	90200827EFM	\$309.95	90200826EFM	\$309.95	76000497EFM	\$284.95
Gold Flake (HCC)	90201397DWG	\$349.95	90201401DWG	\$349.95	—	—
Hot Rod Red Flake-Flame (HCC)	90201397ECN	\$349.95	90201401ECN	\$349.95	76000497ECN	\$304.95
Hot Rod Red Flake-Solid (HCC)	90200827ECN	\$349.95	90200826ECN	\$349.95	—	—
Industrial Gray	90200827EEZ	\$309.95	90200826EEZ	\$309.95	76000497EEZ	\$279.95
Industrial Gray Denim	90200827EFC	\$309.95	90200826EFC	\$309.95	76000497EFC	\$284.95
Kinetic Green	90200827ELD	\$339.95	90200826ELD	\$339.95	76000497ELD	\$299.95
Laguna Orange	90200827ECL	\$339.95	90200826ECL	\$339.95	76000497ECL	\$304.95
Legend Blue Denim	90200827EEL	\$349.95	90200826EEL	\$349.95	76000497EEL	\$299.95
Legend Blue	90200827EEN	\$349.95	90200826EEN	\$349.95	76000497EEN	\$304.95
Midnight Blue	90200827EKA	\$309.95	90200826EKA	\$309.95	76000497EKA	\$279.95
Olive Gold	90200827DZW	\$309.95	90200826DZW	\$309.95	76000497DZW	\$284.95
Scorched Orange	90200827ELG	\$339.95	90200826ELG	\$339.95	76000497ELG	\$299.95
Shattered Flake (HCC)	90200827EEO	\$349.95	90200826EEO	\$349.95	76000497EEO	\$304.95
Silver Flux	90200827ELI	\$339.95	90200826ELI	\$339.95	76000497ELI	\$299.95
Silver Fortune	90200827EFP	\$309.95	90200826EFP	\$309.95	76000497EFP	\$284.95
Sumatra Brown	90200827EFD	\$309.95	90200826EFD	\$309.95	76000497EFD	\$284.95
Superior Blue	90200827DWC	\$309.95	90200826DWC	\$309.95	76000497DWC	\$284.95
Twisted Cherry	90200827EFH	\$309.95	90200826EFH	\$309.95	76000497EFH	\$284.95
Wicked Red	90200827EFF	\$309.95	90200826EFF	\$309.95	76000497EFF	\$284.95
Wicked Red Denim	90200827EKG	\$309.95	90200826EKG	\$309.95	76000497EKG	\$279.95
Velocity Red Sunglo	90200827DZT	\$309.95	90200826DZT	\$309.95	76000497DZT	\$284.95
Vivid Black	90200827DH	\$279.95	90200826DH	\$279.95	76000497DH	\$284.95

CVO™ Primary Color

Auburn Sunglo with Black Hole/Rich Bourbon	90201906EHT	\$349.95	90201907EHT	\$349.95
Black Earth	90200827EGS	\$349.95	90200826EGS	\$349.95
Burgundy Cherry Sunglo	90200827EGO	\$349.95	90200826EGO	\$349.95
Charcoal Slate	90200827BYZ	\$349.95	90200826BYZ	\$349.95
Magnetic Gray with Wineberry/Red Pepper	90201906EHX	\$349.95	90201907EHX	\$349.95
Magnetic Gray	90200827EHU	\$349.95	90200826EHU	\$349.95
Odyssey Blue	90200827EGM	\$349.95	90200826EGM	\$349.95
Palladium Silver	90200827DXM	\$349.95	90200826DXM	\$349.95
Ruby Red	90200827DAA	\$349.95	90200826DAA	\$349.95

Notice: The prices appearing in this catalog are the manufacturer's suggested retail prices. Actual retail prices may vary.

796 COLOR SHOP

Color-Matched Accessories

COLOR-MATCHED INNER FAIRING KIT – BATWING

COLOR-MATCHED INNER FAIRING KIT*

Add a custom touch to your motorcycle with a Color-Matched Inner Fairing and Fairing Cap. Designed to replace the Original Equipment matte black inner fairing, the color-matched finish offers a brilliant contrast to the gauge faces and accessory chrome instrument bezels.

COLOR-MATCHED BATWING INNER FAIRING – Available to fit:

Fits '14-later Electra Glide®, Street Glide® and Ultra Limited models with handlebar mounted mirrors. Kit includes inner fairing, fairing cap, and media door. Does not fit Tri Glide® models.

Fits '14-later Street Glide models with fairing mounted mirrors. Kit includes inner fairing, fairing cap, and media door. Does not fit Tri Glide models.

COLOR-MATCHED TRIKE INNER FAIRING – Available to fit:

Fits '14-later Tri Glide models. Kit includes inner fairing, fairing cap, and media door.



*NOTE: This product is a Paint to Order accessory. Please allow for an average of 5 weeks delivery for this item.



Batwing Inner Fairing
Fits '14-later Electra Glide®
Street Glide® and Ultra Limited models
with handlebar mounted mirrors

Batwing Inner Fairing
Fits '14-later Street Glide models
with fairing mounted mirrors

Batwing Inner Fairing
Fits '14-later Tri Glide® models

Solid Color	P/N	Price	P/N	Price	P/N	Price
Barracuda Silver	—	—	57000389EKR	\$674.95	—	—
Billiard Blue	—	—	57000389EKP	\$674.95	—	—
Black Tempest	57000387EEV	\$674.95	57000389EEV	\$674.95	57000388EEV	\$674.95
Blue Max	—	—	57000389ELE	\$724.95	—	—
Bonneville Salt Denim	—	—	57000389EFW	\$674.95	—	—
Chameleon Flake (HCC)	—	—	57000389EEP	\$774.95	—	—
Crushed Ice Pearl	57000387DZS	\$674.95	57000389DZS	\$674.95	—	—
Electric Blue	57000387EFM	\$674.95	57000389EFM	\$674.95	—	—
Hot Rod Red Flake (HCC)	—	—	57000389ECN	\$774.95	—	—
Industrial Gray Denim	57000387EFC	\$674.95	57000389EFC	\$674.95	—	—
Kinetic Green	57000387ELD	\$724.95	57000389ELD	\$724.95	57000388ELD	\$724.95
Laguna Orange	—	—	57000389ECL	\$724.95	—	—
Legend Blue	—	—	57000389EEN	\$724.95	57000388EEN	\$724.95
Legend Blue Denim	—	—	57000389EEL	\$724.95	—	—
Midnight Blue	57000387EKA	\$674.95	57000389EKA	\$674.95	57000388EKA	\$674.95
Olive Gold	57000387DZW	\$674.95	57000389DZW	\$674.95	—	—
Scorched Orange	57000387ELG	\$724.95	57000389ELG	\$724.95	57000388ELG	\$724.95
Shattered Flake (HCC)	—	—	57000389EEO	\$774.95	—	—
Silver Flux	57000387ELI	\$724.95	57000389ELI	\$724.95	57000388ELI	\$724.95
Silver Fortune	57000387EFP	\$674.95	57000389EFP	\$674.95	57000388EFP	\$674.95
Superior Blue	57000387DWC	\$674.95	57000389DWC	\$674.95	57000388DWC	\$674.95
Twisted Cherry	57000387EFH	\$674.95	57000389EFH	\$674.95	57000388EFH	\$674.95
Velocity Red Sunglo	—	—	57000389DZT	\$674.95	—	—
Vivid Black	57000387DH	\$674.95	57000389DH	\$674.95	57000388DH	\$674.95
Wicked Red	57000387EFF	\$674.95	57000389EFF	\$674.95	57000388EFF	\$674.95
Wicked Red Denim	—	—	57000389EKG	\$674.95	—	—

Notice: The prices appearing in this catalog are the manufacturer's suggested retail prices. Actual retail prices may vary.

COLOR-MATCHED INNER FAIRING KIT – ROAD GLIDE®

COLOR-MATCHED INNER FAIRING KIT*

Add a custom touch to your motorcycle with a Color-Matched Inner Fairing and Fairing Cap. Designed to replace the Original Equipment matte black inner fairing, the color-matched finish offers a brilliant contrast to the gauge faces and accessory chrome instrument bezels.

COLOR-MATCHED ROAD GLIDE® INNER FAIRING – Available to fit: Fits '15-later Road Glide® models. Kit includes Color-Matched instrument housing. Color-Matched Inner Fairing Air Duct sold separately.

COLOR-MATCHED ROAD GLIDE AIR DUCT – Available to fit: Fits '15-later Road Glide models. Color-Matched Inner Fairing sold separately. Kit includes air duct baffle and actuator assembly.



*NOTE: This product is a Paint to Order accessory. Please allow for an average of 5 weeks delivery for this item.

Solid Color	Road Glide Inner Fairing Fits '15-later models		Road Glide Fairing Air Duct Fits '15-later models	
	P/N	Price	P/N	Price
Billiard Blue	57000482EKP	\$1,149.95	29200102EKP	\$349.95
Black Denim	—	—	—	—
Black Earth	—	—	—	—
Blue Max	57000482ELE	\$1,199.95	29200102ELE	\$379.95
Bonneville Blue	—	—	29200102ECJ	\$379.95
Bonneville Salt Pearl	57000482EFU	\$1,149.95	29200102EFU	\$349.95
Chameleon Flake (HCC)	57000482EEP	\$1,249.95	29200102EEP	\$399.95
Electric Blue	57000482EFM	\$1,149.95	29200102EFM	\$349.95
Gunship Gray	—	—	—	—
Hot Rod Red Flake (HCC)	57000482ECN	\$1,249.95	29200102ECN	\$399.95
Industrial Gray	57000482EEZ	\$1,149.95	29200102EEZ	\$349.95
Industrial Gray Denim	57000482EFC	\$1,149.95	29200102EFC	\$349.95
Kinetic Green	57000482ELD	\$1,199.95	29200102ELD	\$379.95
Laguna Orange	57000482ECL	\$1,199.95	29200102ECL	\$379.95
Midnight Blue	57000482EKA	\$1,149.95	29200102EKA	\$349.95
Olive Gold	57000482DZW	\$1,149.95	29200102DZW	\$349.95
Orange Lava	—	—	—	—
Scorched Orange	57000482ELG	\$1,199.95	29200102ELG	\$379.95
Shattered Flake (HCC)	57000482EEO	\$1,249.95	29200102EEO	\$399.95
Silver Flux	57000482ELI	\$1,199.95	29200102ELI	\$379.95
Silver Fortune	57000482EFP	\$1,149.95	29200102EFP	\$349.95
Sumatra Brown	57000482EFD	\$1,149.95	29200102EFD	\$349.95
Superior Blue	57000482DWC	\$1,149.95	—	—
Twisted Cherry	57000482EFH	\$1,149.95	29200102EFH	\$349.95
Velocity Red Sunglo	57000482DZT	\$1,149.95	29200102DZT	\$349.95
Vivid Black	57000482DH	\$1,149.95	29200102DH	\$349.95
Wicked Red	57000482EFF	\$1,149.95	29200102EFF	\$349.95
Wicked Red Denim	57000482EKG	\$1,149.95	29200102EKG	\$349.95

Notice: The prices appearing in this catalog are the manufacturer's suggested retail prices. Actual retail prices may vary.

798 COLOR SHOP

Color-Matched Accessories

KING TOUR-PAK® LUGGAGE – '14-LATER MODELS



Available to fit:
Fits '14-later Road King®, Road Glide®, Street Glide® and select CVO™ models. Separate purchase of H-D® Detachables™ Two-Up or Solo Tour-Pak® Mounting Rack and applicable Docking Hardware is required. Separate purchase of Tour-Pak Lock Kit P/N 90300030 is required.

CHOPPED TOUR-PAK LUGGAGE – '14-LATER MODELS



Available to fit:
Fits '14-later Road King, Road Glide, Street Glide and select CVO models. Does not fit FLRT models. Separate purchase of H-D Detachables Two-Up or Solo Tour-Pak Mounting Rack and applicable Docking Hardware is required. Separate purchase of Tour-Pak Lock Kit P/N 90300030 is required.

Solid Color	King Tour-Pak® Luggage		Chopped Tour-Pak Luggage	
	P/N	Price	P/N	Price
Primed/Paintable	53000404	\$699.95	53000405	\$699.95
Barracuda Silver	53000399EKR	\$849.95	53000402EKR	\$849.95
Billiard Blue	53000399EKP	\$849.95	53000402EKP	\$849.95
Black Denim	53000399BYM	\$849.95	53000402BYM	\$849.95
Black Tempest	53000399EEV	\$849.95	53000402EEV	\$849.95
Blue Max	53000736ELE	\$899.95	53000731ELE	\$899.95
Bonneville Salt Denim	53000399EFW	\$849.95	53000402EFW	\$849.95
Bonneville Salt Pearl	53000399EFU	\$849.95	53000402EFU	\$849.95
Chameleon Flake (HCC)	53000399EEP	\$1,599.95	53000402EEP	\$1,599.95
Charcoal Denim	53000399DZN	\$849.95	53000402DZN	\$849.95
Crushed Ice Pearl	53000399DZS	\$849.95	53000402DZS	\$849.95
Electric Blue	53000399EFM	\$849.95	53000402EFM	\$849.95
Hot Rod Red Flake-Flame (HCC)	53000521ECN	\$1,599.95	53000527ECN	\$1,599.95
Hot Rod Red Flake-Solid (HCC)	53000399ECN	\$1,599.95	53000402ECN	\$1,599.95
Industrial Gray	53000399EEZ	\$849.95	53000402EEZ	\$849.95
Industrial Gray Denim	53000399EFC	\$849.95	53000402EFC	\$849.95
Kinetic Green	53000736ELD	\$899.95	53000731ELD	\$899.95
Laguna Orange	53000574ECL	\$899.95	53000577ECL	\$899.95
Legend Blue Denim	53000399EEL	\$899.95	53000402EEL	\$899.95
Midnight Blue	53000399EKA	\$849.95	53000402EKA	\$849.95
Olive Gold	53000399DZW	\$849.95	53000402DZW	\$849.95
Shattered Flake (HCC)	53000399EEO	\$1,599.95	53000402EEO	\$1,599.95
Silver Fortune	53000399EFP	\$849.95	53000402EFP	\$849.95
Sumatra Brown	53000399EFD	\$849.95	53000402EFD	\$849.95
Superior Blue	53000399DWC	\$849.95	53000402DWC	\$849.95
Twisted Cherry	53000399EFH	\$849.95	53000402EFH	\$849.95
Velocity Red Sunglo	53000399DZT	\$849.95	53000402DZT	\$849.95
Vivid Black	53000399DH	\$849.95	53000402DH	\$849.95
Wicked Red	53000399EFF	\$849.95	53000402EFF	\$849.95
Wicked Red Denim	53000399EKG	\$849.95	53000402EKG	\$849.95

NOTE: Color-Matched Tour-Paks do not include backrest pads.

Notice: The prices appearing in this catalog are the manufacturer's suggested retail prices. Actual retail prices may vary.

TOUR-PAK® LUGGAGE

Solid Color	Inner/Outer Pinstripe	King Tour-Pak® Luggage		Chopped Tour-Pak Luggage	
		P/N	Price	P/N	Price
Mysterious Red Sunglo	Medium Red/Burgundy	53000377DSX	\$899.95	—	—
Vivid Black	Medium Silver/Medium Silver	53000377BHY	\$899.95	—	—
Two Tone Solid Color/Panel	Inner/Outer Pinstripe				
Electric Blue/Silver Fortune	Blue/Warm Silver	53000377EGA	\$949.95	53000375EGA	\$949.95
Legend Blue/Vivid Black	Blue/Medium Silver/Blue	53000643EEM	\$1,049.95	53000646EEM	\$899.95
Olive Gold/Black Tempest	Olive Tan/Roman Gold	53000377EGE	\$949.95	53000375EGE	\$949.95
Scorched Orange/Black Denim	Black	53000662ELF	\$949.95	53000660ELF	\$949.95
Silver Flux/Black Fuse	Black	53000662ELH	\$949.95	53000660ELH	\$949.95
Silver Fortune/Sumatra Brown	Burgundy/Warm Silver	53000377EGC	\$949.95	53000375EGC	\$949.95
Wicked Red/Twisted Cherry	Brick Red/Tomato Red	53000377EGG	\$949.95	53000375EGG	\$949.95
CVO™ Primary Color					
Black Earth with Vivid Black		53000654EHA	\$1,599.95	53000651EHA	\$1,599.95
Black Forest		53000652EJD	\$1,599.95	53000649EJD	\$1,599.95
Black Forest with Wineberry		53000654EJC	\$1,599.95	53000651EJC	\$1,599.95
Candy Cobalt with Indigo Ink		92200074EDF	\$1,599.95	92200073EDF	\$1,599.95
Charred Steel with Lightning Silver		53000663EJB	\$1,599.95	53000651EJB	\$1,599.95
Dark Alloy with Black Denim		53000653EGW	\$1,599.95	53000650EGW	\$1,599.95
Dark Slate Candy with Arctic Black		92200074EDN	\$1,599.95	92200073EDN	\$1,599.95
Gunship Gray		53000652EGZ	\$1,599.95	53000649EGZ	\$1,599.95
Lightning Silver and Charcoal Steel with Black Hole		53000700EJE	\$1,599.95	53000699EJE	\$1,599.95
Mako Shark		53000652EJH	\$1,599.95	53000649EJH	\$1,599.95
Orange Lava with Black Denim		53000662EGY	\$1,599.95	53000660EGY	\$1,599.95
Orange Lava with Dark Alloy		53000663EHB	\$1,599.95	53000661EHB	\$1,599.95
Red Pepper and Magnetic Gray with Black Hole		53000716EJF	\$1,599.95	53000699EJF	\$1,599.95
Starfire Black with Atomic Red		92200074EDH	\$1,599.95	92200073EDH	\$1,599.95
Sunburst Orange with Starfire Black		92200074EDG	\$1,599.95	92200073EDG	\$1,599.95



'19 CVO BLACK FOREST



'19 CVO BLACK FOREST & WINEBERRY



'19 CVO LIGHTNING SILVER & CHARRED STEEL WITH BLACK HOLE



'19 CVO RED PEPPER & MAGNETIC GRAY WITH BLACK HOLE



'19 CVO MAKO SHARK



'19 CVO CHARRED STEEL & LIGHTNING SILVER

COLOR SHOP

Notice: The prices appearing in this catalog are the manufacturer's suggested retail prices. Actual retail prices may vary.

800 COLOR SHOP

Color-Matched Accessories

KING TOUR-PAK® LUGGAGE – '97-'13 MODELS



Available to fit:

Fits '09-'13 Electra Glide® Standard, Road King®, Road Glide®, Street Glide®, Street Glide Trike and select CVO™ models. Separate purchase of detachable Two-Up or Solo Tour-Pak® Mounting Rack and applicable Docking Hardware is required. Separate purchase of Tour-Pak Lock Kit P/N 53194-07 is required. FLHXXX models require addition of Tour-Pak Installation Kit P/N 54144-10 and Spacer Kit P/N 83294-10.

53963-10DH Vivid Black. **\$849.95**

Fits '06-'08 Electra Glide Standard, Road King, Road Glide and Street Glide models. Separate purchase of detachable Two-Up or Solo Tour-Pak Mounting Rack and applicable Docking Hardware is required. Separate purchase of Tour-Pak Lock Kit P/N 53194-07 is required.

53270-06DH Vivid Black. **\$849.95**

Fits '97-'05 Electra Glide Standard, Road King, and Road Glide models. Separate purchase of detachable Two-Up or Solo Tour-Pak Mounting Rack and applicable Docking Hardware is required. Separate purchase of Tour-Pak Lock Kit P/N 53194-07 is required.

53116-97DH Vivid Black. **\$849.95**

NOTE: Color-Matched Tour-Paks do not include backrest pads.

CHOPPED TOUR-PAK LUGGAGE – '97-'13 MODELS



Available to fit:

Fits '97-'13 Touring and Trike models. FLHTCUTG models require separate purchase of Spacer Kit P/N 83294-10. FLHXXX models require addition of Tour-Pak Installation Kit P/N 54144-10 and Spacer Kit P/N 83294-10.

53111-96DH Vivid Black. **\$849.95**

NOTE: Color-Matched Tour-Paks do not include backrest pads.

COLOR-MATCHED SADDLEBAG FILLER STRIPS

SADDLEBAG FILLER STRIPS

For those who seek perfection, these kits fill in the gaps between the fender and the rear of the saddlebags, hiding the saddlebag mounting bracket. Choose between primed, highly polished chrome, or Color-Matched to your sheet metal and bags for a truly custom look.

Available to fit:

Solid

Fits '14-later Touring (except FLHRXS, FLHX, FLHXS, FLTRX, FLHXSE, FLTRXS and FLTRXSE) models with hard saddlebags. Does not fit with accessory Saddlebag Guard Rails.



Saddlebag Filler Strips—Solid

Solid Color	P/N	Price
Chrome	90200873	\$169.95
Barracuda Silver	90200872EKR	\$199.95
Billiard Blue	90200872EKP	\$199.95
Black Tempest	90200872EEV	\$199.95
Bonneville Salt Pearl	90200872EFU	\$199.95
Charcoal Denim	90200872DZN	\$199.95
Electric Blue	90200872EFM	\$199.95
Hot Rod Red Flake (HCC)	90200872ECN	\$229.95
Industrial Gray	90200872EEZ	\$199.95
Industrial Gray Denim	90200872EFC	\$199.95
Kinetic Green	90200872ELD	\$229.95
Laguna Orange	90200872ECL	\$229.95
Legend Blue	90200872EEN	\$229.95
Midnight Blue	90200872EKA	\$199.95
Olive Gold	90200872DZW	\$199.95
Scorched Orange	90200872ELG	\$229.95
Shattered Flake (HCC)	90200872EEO	\$229.95
Silver Flux	90200872ELI	\$229.95
Silver Fortune	90200872EFP	\$199.95
Twisted Cherry	90200872EFH	\$199.95
Vivid Black	90200872DH	\$199.95
Wicked Red	90200872EFF	\$199.95

Notice: The prices appearing in this catalog are the manufacturer's suggested retail prices. Actual retail prices may vary.

COLOR-MATCHED TOUR-PAK® & SADDLEBAG SPOILERS



COLOR-MATCHED TOUR-PAK® SPOILER KIT*

The combination of contoured styling and the practicality of an integrated auxiliary LED running/brake light blend form and function into the Tour-Pak® Spoiler.

'14-later models

Fits '14-later Touring models equipped with King or Chopped Tour-Pak luggage. Installation requires separate purchase of Tour-Pak Lid Spoiler Light Kit P/N 53000238 or 53000239.



COLOR-MATCHED SADDLEBAG LID SPOILER KIT*

Aero styling and a practical addition to rear visibility. Color-Matched Saddlebag Lid Spoilers equipped with bright fast-acting LED lamps that will get you noticed.

'14-later models

Fits '14-later Touring models with hard saddlebags. Installation requires separate purchase of Saddlebag Lid Spoiler Light Kit P/N 90200735 or 90200736.

*NOTE: This product is a Paint to Order accessory. Please allow for an average of 5 weeks delivery for this item.

Solid Color	Tour-Pak Spoiler Fits '14-later models		Saddlebag Lid Spoiler Fits '14-later models	
Primed/Paintable	57200086BDK	\$159.95	57200087BDK	\$129.95
Barracuda Silver	57200086EKR	\$179.95	57200087EKR	\$149.95
Billet Silver	57200086DZP	\$179.95	57200087DZP	\$149.95
Billiard Blue	57200086EKP	\$179.95	57200087EKP	\$149.95
Black Gold Flake (HCC)	57200086EAI	\$189.95	57200087EAI	\$159.95
Black Tempest	57200086EEV	\$179.95	57200087EEV	\$149.95
Blue Max	57200086ELE	\$189.95	57200087ELE	\$159.95
Bonneville Salt Denim	57200086EFW	\$179.95	57200087EFW	\$149.95
Bonneville Salt Pearl	57200086EFU	\$179.95	57200087EFU	\$149.95
Chameleon Flake (HCC)	57200086EEP	\$189.95	57200087EEP	\$159.95
Charcoal Denim	57200086DZN	\$179.95	57200087DZN	\$149.95
Cosmic Blue Pearl	57200086DZZ	\$189.95	57200087DZZ	\$159.95
Crushed Ice Pearl	57200086DZS	\$179.95	57200087DZS	\$149.95
Electric Blue	57200086EFM	\$179.95	57200087EFM	\$149.95
Gold Flake (HCC)	57200086DWG	\$189.95	57200087DWG	\$159.95
Hot Rod Red Flake (HCC)	57200086ECN	\$189.95	57200087ECN	\$159.95
Industrial Gray	57200086EEZ	\$179.95	57200087EEZ	\$149.95
Industrial Gray Denim	57200086EFC	\$179.95	57200087EFC	\$149.95
Kinetic Green	57200086ELD	\$189.95	57200087ELD	\$159.95
Laguna Orange	57200086ECL	\$189.95	57200087ECL	\$159.95
Legend Blue Denim	57200086EEL	\$189.95	57200087EEL	\$159.95
Legend Blue	57200086EEN	\$189.95	57200087EEN	\$159.95
Midnight Blue	57200086EKA	\$179.95	57200087EKA	\$149.95
Olive Gold	57200086DZW	\$179.95	57200087DZW	\$149.95
Purple Fire	57200086DZY	\$189.95	57200087DZY	\$159.95
Scorched Orange	57200086ELG	\$189.95	57200087ELG	\$159.95
Shattered Flake (HCC)	57200086EEO	\$189.95	57200087EEO	\$159.95
Silver Flux	57200086ELI	\$189.95	57200087ELI	\$159.95
Silver Fortune	57200086EFP	\$179.95	57200087EFP	\$149.95
Sumatra Brown	57200086EFD	\$179.95	57200087EFD	\$149.95
Superior Blue	57200086DWC	\$179.95	57200087DWC	\$149.95
Twisted Cherry	57200086EFH	\$179.95	57200087EFH	\$149.95
Velocity Red Sunglo	-	-	57200087DZT	\$149.95
Vivid Black	57200086DH	\$179.95	57200087DH	\$149.95
Wicked Red	57200086EFF	\$179.95	57200087EFF	\$149.95
Wicked Red Denim	57200086EKG	\$179.95	57200087EKG	\$149.95

CVO™ Primary Color

Auburn Sunglo	57200086EHP	\$199.95	57200087EHP	\$169.95
Black Earth	57200086EGS	\$199.95	57200087EGS	\$169.95
Black Forest	57200086EJD	\$199.95	57200087EJD	\$169.95
Burgundy Cherry Sunglo	57200086EGO	\$199.95	57200087EGO	\$169.95
Charcoal Slate	57200086BYZ	\$199.95	57200087BYZ	\$169.95
Charred Steel	57200086EJA	\$199.95	57200087EJA	\$169.95
Dark Alloy	57200086EGV	\$199.95	57200087EGV	\$169.95
Gunship Gray	57200086EGZ	\$199.95	57200087EGZ	\$169.95
Indigo Ink	57200086EDO	\$199.95	57200087EDO	\$169.95
Lightning Silver	57200086EHY	\$199.95	57200087EHY	\$169.95
Magnetic Gray	57200086EHU	\$199.95	57200087EHU	\$169.95
Mako Shark	57200086EJH	\$199.95	57200087EJH	\$169.95
Orange Lava	57200086EGX	\$199.95	57200087EGX	\$169.95
Red Pepper	57200086EHV	\$199.95	57200087EHV	\$169.95

Notice: The prices appearing in this catalog are the manufacturer's suggested retail prices. Actual retail prices may vary.

802 COLOR SHOP

Café Custom Accessories

A. COLOR-MATCHED CAFÉ CUSTOM TAIL SECTION

Create your own link to the Sportster®-based racing and performance bikes of the '60s and '70s. This fast-back solo seat and tail section mirrors the look and feel of the iconic 1977-78 Harley-Davidson® XLCR Café Racer model, and re-imagines the style for the modern era. Ideal for use with Clip-On or Sportster Clubman Handlebars and mid- or rear-set foot controls, this seat provides the perfect lay-down aggressive riding posture for splitting lanes or carving corners. The seat's upturned tail and longer nose positions the solo rider closer to the tank for better weight balance, quicker steering and added front-end feedback. The Tail Section is a true bolt-on design that wraps the fender struts, so unlike other café bike kits, there is no cutting, welding or frame modifications required. Installation is reversible – you can return easily your bike to the stock look. The complete kit features a sweeping composite tail section with a steel inner support, a deep solo bucket seat with backstop pad, and all necessary installation hardware.

Fits '10-later XL883N, XL1200CX, XL1200N, XL1200NS, XL1200V, XL1200X and XL1200XS models. Separate purchase of License Plate Bracket Kit P/N 67900360 for Canada models or P/N 67900359 for HDI models is required.

59500644	Unpainted.	\$574.95
59500560ELM	Billiard White.	\$749.95
59500560BYM	Black Denim.	\$749.95
59500560ELE	Blue Max.	\$799.95
59500560EFW	Bonneville Salt Denim.	\$749.95
59500560EEP	Chameleon Flake (HCC).	\$849.95
59500689EGB	Electric Blue/Silver Fortune.	\$799.95
59500560EEZ	Industrial Gray.	\$749.95
59500560EFC	Industrial Gray Denim.	\$749.95
59500689EGL	Industrial Gray Denim/Black Denim.	\$799.95
59500560EEL	Legend Blue Denim.	\$799.95
59500560EKN	Rawhide Denim.	\$749.95
59500560EKI	Rugged Gold Denim.	\$749.95
59500786ELF	Scorched Orange/Black Denim.	\$799.95
59500560EEO	Shattered Flake (HCC).	\$849.95
59500786ELH	Silver Flux/Black Fuse.	\$799.95
59500560EFD	Sumatra Brown.	\$749.95
59500560EFH	Twisted Cherry.	\$749.95
59500560DHD	Vivid Black.	\$699.95
59500560EFF	Wicked Red.	\$749.95
59500560EKG	Wicked Red Denim.	\$749.95

B. LICENSE PLATE BRACKET KIT

Required for installation of Café Custom Tail Section P/N 59500644 or 59500560DH on models in specific International markets.

Fits '07-later XL883N, XL1200CX, XL1200N, XL1200NS, XL1200V, XL1200X and XL1200XS models equipped with Café Custom Tail Section.

67900360	Canada Models.	\$149.95
67900359	HDI Models.	\$49.95



A. COLOR-MATCHED CAFÉ CUSTOM TAIL SECTION (WICKED RED SHOWN)



A. CAFÉ CUSTOM TAIL SECTION – UNPAINTED



A. CAFÉ CUSTOM TAIL SECTION – COLOR-MATCHED



B. LICENSE PLATE BRACKET KIT CANADA MODELS



B. LICENSE PLATE BRACKET KIT HDI MODELS

Notice: The prices appearing in this catalog are the manufacturer's suggested retail prices. Actual retail prices may vary.

C. PAINTS

Touch-up paint is available in handy 1/2 oz applicator bottles for all late model Harley-Davidson® motorcycles including CVO™ models. Aerosol and quart containers are also available. See your Authorized Harley-Davidson Dealer for a complete listing of paint.

NOTE: Quart containers of Harley-Davidson Acrylic Urethane paint and urethane activator material are designed for application only by professional, trained personnel using proper equipment under controlled conditions, and they are not intended for sale to the general public.

Black Texture

For use with '95-later Engine and Transmission.

98605BF*	Touch-Up Pen.	\$11.95
98600BF*	Touch-Up Bottle.	\$11.95
98606BF	Aerosol.	\$23.95

Silver Bead Blast

For use with '98-later Engine and Transmission.

98600BY*	Touch-Up Bottle.	\$11.95
98606BY	Aerosol.	\$23.95

Clear Coat

Used to fill in clear coating over chips and surface scratches.

98600EK*	Touch-Up Bottle.	\$11.95
98606EK	Aerosol.	\$23.95
98628EK	Quart. Two-Part Urethane.	\$84.95
99825-02	Urethane Activator.	\$55.95

Black Leather Touch-Up Pens

A convenient way to fix scratches, scuffed and worn pouches, saddlebags, seats and other leather products. Just touch-up the damaged area, wipe off excess, let dry and then buff with a soft cloth to blend color.

98605AX*		\$11.95
-----------------	--	----------------

Black Frame Paint Touch-up Pen

Dispensed from an easy-to-use paint pen, this paint is an easy way to touch-up minor nicks and scratches.

93936*		\$5.95
---------------	--	---------------

*NOTE: Price shown is price per each bottle or pen. There are two bottles or pens per package.



C. PAINTS

Notice: The prices appearing in this catalog are the manufacturer's suggested retail prices. Actual retail prices may vary.

804 COLOR SHOP

Medallions & Decals

A. FUEL TANK NAMEPLATE AND ADAPTER KITS

For those of you with nostalgia in mind, our popular fuel tank trims fit a wide selection of early models. In addition, we now offer adapter kits for later models. The adapter kits come with all necessary hardware for installation of fuel tank trim on later models. Adapter Kit Brackets are self-adhesive to accommodate most universal applications. Due to fuel tank shape variability, test fit relevant adapter plate to desired fuel tank to ensure full surface contact before adhering to tank. All trim and adapter kits are sold in pairs.

1. 61769-47T Fits all '47-'50 models. **\$43.95**

Adapter Kit for P/N 61769-47T

61783-92T **\$23.95**
Fits Fat Bob® fuel tanks (except '08-later Touring and Trike models).

2. 61776-61T Fits '61-'62 FL models. **\$48.95**

Adapter Kit for P/N 61776-61T

61740-90T **\$23.95**
Fits Fat Bob fuel tanks (except '08-later Touring and Trike models).

3. 61775-59T Fits '59-'60 FL models. **\$43.95**

Adapter Kit for P/N 61775-59T

61742-93T **\$23.95**
Fits Fat Bob fuel tanks (except '08-later Touring and Trike models).

4. 61769-40T Fits '36-'46 Big Twin models. **\$43.95**

Adapter Kit for P/N 61769-40T

61785-92T **\$23.95**
Fits Fat Bob fuel tanks (except '08-later Touring and Trike models).

5. 61774-51T **\$43.95**
Fits '51-'54 Big Twin and '52-'54 K models.

Adapter Kit for P/N 61774-51T

61784-92T **\$23.95**
Fits Fat Bob fuel tanks (except '08-later Touring and Trike models).

6. 61777-63T Fits '63-'65 FL and XL models. **\$38.95**

Adapter Kit for P/N 61777-63T

61782-91T **\$23.95**
Fits Fat Bob fuel tanks (except '08-later Touring and Trike models).

7. 61771-66TB **\$38.95**
Fits '66-'71 FL, XL and '71 FX models.

Adapter Kit for P/N 61771-66TB

61741-93T **\$23.95**
Fits Fat Bob fuel tanks (except '08-later Touring and Trike models).

8. 61814-55T Chrome. **\$43.95**
Fits '55-'56 FL models.

Adapter Kit for P/N 61814-55T

61840-94T **\$23.95**
Fits Fat Bob fuel tanks (except '08-later Touring and Trike models).

B. EAGLE FAIRING DECAL

Gives your fairing that custom look. Multi-colored. Made in the U.S.A.

14093-84 Black Background. **\$44.95**
Eagle decal fits '13-earlier FL, FLH and FLHT fairings.



A. FUEL TANK NAMEPLATE AND ADAPTER KITS



B. EAGLE FAIRING DECAL

Notice: The prices appearing in this catalog are the manufacturer's suggested retail prices. Actual retail prices may vary.



C. DECORATIVE MEDALLIONS

C. DECORATIVE MEDALLIONS

Display a touch of attitude. Ideal for use on plate-style sissy bar uprights and battery covers, the adhesive backing on these high-quality cast medallions allows easy installation on most flat surfaces. The medallions are available in black accented chrome or antique nickel finishes. The Oval Bar & Shield logo and the Bar & Shield with Wings medallions look great with Chrome Backrest Mount P/N 52527-01 and 52531-01.

1. Skull – Chrome		
91718-02	3-5/8" x 3".	\$27.95
2. Skull with Wings – Chrome		
91723-02	5" x 1-1/2".	\$27.95
3. Bar & Shield Logo with Wings – Chrome		
91745-02	4" x 1-1/2".	\$19.95
4. Oval with Bar & Shield Logo – Chrome		
91716-02	3-3/8" x 1-1/2".	\$19.95

D. SELF-ADHESIVE MEDALLIONS AND SISSY BAR UPRIGHT INSERTS

Works great on derby covers, timer covers, medallion plate-style sissy bar uprights and chrome battery covers.

Made In U.S.A. Eagle		
1. 99000-77	Large Medallion.	\$25.95
Bar & Shield Logo		
2. 91815-85	Large Medallion.	\$27.95
Eagle with Bar & Shield Logo		
3. 91811-85	Large Medallion.	\$27.95



D. SELF-ADHESIVE MEDALLIONS AND SISSY BAR UPRIGHT INSERTS

E. LIVE TO RIDE LOGO MEDALLIONS

These self-adhesive medallions are made of durable ABS plastic, and look great on sissy bars, battery covers, Tour-Pak® luggage carriers, saddlebags, etc.

99027-90T	3.5" – Gold.	\$25.95
------------------	--------------	----------------

F. METAL ADHESIVE-BACKED LOGO

All you do is choose the style you like, select a Timer or Derby Cover and affix the medallion to the cover. Works great on medallion, plate-style sissy bar uprights and chrome battery covers.

99352-82Z	Bar & Shield Logo. Universal.	\$11.95
------------------	-------------------------------	----------------



E. LIVE TO RIDE LOGO MEDALLIONS – CHROME AND GOLD



F. METAL ADHESIVE-BACKED LOGO

Notice: The prices appearing in this catalog are the manufacturer's suggested retail prices. Actual retail prices may vary.

GARAGE

The exceptional deserves to be treated exceptionally. Show your ride some TLC with cleaning and service supplies created by the only people who know and love your motorcycle as much as you — the experts at Harley-Davidson.



SURFACE CARE PRODUCT MAP

CLEAN

GENERAL	 <p>93600056 US Harley® Bike Wash Kit</p>	 <p>94844-10 GLOBAL Cleaning Brush Kit</p>	 <p>93600110 GLOBAL Bug Eater Sponge</p>	 <p>94811-10 Harley® Bike Wash Bucket GLOBAL</p>
	 <p>94651-09 N. AMERICA HOG® Blaster Motorcycle Dryer</p>	 <p>93600077 INT 93600023 US Sunwash® Bike Soap</p>	 <p>93600071 INT 93600011 US Quick Wash</p>	
		 <p>94791-01 GLOBAL Synthetic Drying Chamois</p>	 <p>93600075 INT 93600022 US Bug Remover</p>	 <p>94760-99 Wash Mitt GLOBAL</p>
GLASS	 <p>93600116 GLOBAL LCD Screen Cleaner Individual Wipes</p>	 <p>93600067 Windshield Cleaner Individual Wipes N. AMERICA</p>		 <p>93600084 INT 93600029 US Spray Cleaner & Polish</p>
PAINT	 <p>93600078 INT 93600064 US Denim Paint Cleaner</p>			 <p>93600084 INT 93600029 US Spray Cleaner & Polish</p>
LEATHER, VINYL & TRIM		 <p>93600010 GLOBAL Seat, Saddlebag & Trim Cleaner</p>		
METAL: CHROME, ALUMINUM & ENGINE	 <p>93600082 INT 93600031 US Chrome Clean & Shine</p>	 <p>93600069 INT 93600001 US Boot Mark Remover (For use on chrome exhaust)</p>		 <p>93600084 INT 93600029 US Spray Cleaner & Polish</p>
WHEEL & TIRE	 <p>93600076 INT 93600024 US Wheel & Tire Cleaner</p>		 <p>43078-99 GLOBAL Wheel & Spoke Brush</p>	

DETAIL

PROTECT

93600057A US
Harley®
Detail & Protect Kit



94663-02 GLOBAL
Microfiber
Detailing Cloth



93600114 GLOBAL
Disposable Detailing
Softcloths



93600073 INT
93600062 US
Gloss Detailer



93600084 INT
93600029 US
Spray Cleaner & Polish



93600079 INT
93600026 US
Glaze™ Poly Sealant



93600073 INT
93600062 US
Gloss Detailer



93600032 GLOBAL
Windshield Water
Repellent



93600074 INT
93600025 US
Scratch & Swirl Repair



93600073 INT
93600062 US
Gloss Detailer



93600079 INT
93600026 US
Glaze™ Poly Sealant



93600081 INT
93600033 US
Black Leather Rejuvenator



93600115 GLOBAL
Black Inner Fairing
& Trim Rejuvenator



93600080 INT
93600034 US
Leather Protectant



93600068 INT
93600002 US
Engine Brightener



93600083 INT
93600028 US
Bare Metal Polish
(Not for use on chrome)



93600079 INT
93600026 US
Glaze™ Poly Sealant
(Not for engine)



93600083 INT
93600028 US
Bare Metal Polish
(For use on bare aluminum
surfaces only)



93600063 GLOBAL
Bare Aluminum
Wheel Protectant
Individual Wipes



810 GARAGE

Surface Care – Clean

A. QUICK WASH

Fast and easy to use, Quick Wash is tough on dirt, oil and bugs, but gentle on other surfaces. This all-over bike cleaner is safe for use on all surfaces of your motorcycle and does not strip wax, corrode fasteners or spokes or stain leather and vinyl seats and saddlebags. Just spray it on and hose it off. Quick Wash gets into hard-to-reach spaces and cleans without scrubbing. Sheeting action rinses clean and prevents spotting. Available in easy-to-handle trigger pump bottles and convenient refill containers.

16 fl oz (473 ml) Spray Bottle.

93600011 U.S. **\$7.95**

93600071 International. **\$7.95**

32 fl oz (946 ml) Trigger Bottle.

93600012 U.S. **\$15.95**

1 gallon (3.79 L) Refill Bottle.

93600013 U.S. **\$42.95**

B. SUNWASH® BIKE SOAP

This revolutionary cleaner lets riders wash their bikes where they want to – in the sun. Most bike wash products can be used only on cool days or in the shade. Sunwash® Bike Soap has a unique sheeting action that prevents hard water spots, and rinses clean even on hot days in the sun. Safe for use on all vehicle surfaces including denim paint. Biodegradable.

8 fl oz (236 ml) Bottle.

93600023 U.S. **\$6.95**

93600077 International. **\$7.95**

C. SPRAY CLEANER & POLISH

Keep your bike clean, even when you are away from home. Aerosol waterless quick cleaner/detailer is the perfect choice when the motorcycle is too clean to wash but too dirty to ride. Safe for use on metal, painted, plastic and windshield surfaces, this cleaning spray dissolves road grime and bugs for quick and easy cleaning and detailing. The spray floats dirt off the motorcycle, reduces static attraction to dust and leaves the surface with a great shine and UV protection.

11 oz (311 g) Aerosol Can.

93600029 U.S. **\$7.95**

93600084 International. **\$7.95**

Also available:

SPRAY CLEANER & POLISH + MICROFIBER KIT

The perfect on-the-road cleaning companion. Kit contains:

- *Spray Cleaner & Polish* aerosol waterless quick cleaner/detailer floats dirt and dust off the surface for a quick and easy cleanup.
- *Microfiber Detailing Cloth* is soft and durable for detailing, cleaning or buffing. The washable cloth can be used wet or dry and is safe for use on all surfaces and finishes.

93600108 U.S. **\$11.95**

93600109 International. **\$13.95**

D. BUG REMOVER

Remove bugs with little effort. Bugs have natural acids in their systems that can prove to be very damaging to motorcycle finishes if not removed. Bug Remover melts away bugs and is safe for use on metal, painted and plastic surfaces, including H-D® windshields. Biodegradable.

16 fl oz (473 ml) Spray Bottle.

93600022 U.S. **\$8.95**

93600075 International. **\$9.95**

Single-Use Wipe.

97400-10 One Single-Use Wipe. **\$1.51**



A. QUICK WASH



B. SUNWASH BIKE SOAP



C. SPRAY CLEANER & MICROFIBER KIT



D. BUG REMOVER



D. BUG REMOVER – INDIVIDUAL WIPES

Notice: The prices appearing in this catalog are the manufacturer's suggested retail prices. Actual retail prices may vary.

E. WHEEL & TIRE CLEANER

The road provides plenty of nasty elements that can be potentially damaging to the finish of motorcycle wheels. Wheel & Tire Cleaner safely removes brake dust and road grime from wheels, tires and whitewalls in seconds. Also recommended for cleaning Harley-Davidson® black-coated exhaust pipes and mufflers. Biodegradable.

16 fl oz (473 ml) Spray Bottle.

93600024	U.S.	\$8.95
93600076	International.	\$9.95

F. DENIM PAINT CLEANER

Specially formulated for denim paint, this handy quick detailer cleans and protects the silky matte finish. Cleaner won't streak or leave residue. Just spray and gently wipe away oils, fingerprints and dust. Compatible with all surfaces on Harley-Davidson motorcycles, this formula cleans without buffing, so you can avoid "polishing" the denim surface. Heavily soiled surfaces should be washed with Sunwash® Bike Soap and water before application.

16 fl oz (473 ml) Spray Bottle.

93600064	U.S.	\$8.95
93600078	International.	\$8.95

G. SEAT, SADDLEBAG & TRIM CLEANER

The perfect quick detailer for vinyl, leather and plastic surfaces, this one-step treatment cleans and refreshes without leaving a greasy residue. Just mist on and wipe away the accumulated dust and grime that dulls the finish. Ideal for use on inner fairings, dash panels, seats and saddlebags, this spray cleaner dries to a healthy satin shine and contains no waxes or other solvents that can dull the surface of vinyl and plastic.

93600010 8 fl oz (236 ml) Spray Bottle. **\$9.95**

H. BOOT MARK REMOVER

Return the shine to your chrome exhaust. Formulated to break down rubber marks and road tar, Boot Mark Remover exhaust cleaner is applied directly to the soiled area. Just cover the target area with gel when the exhaust is cool and let it do its thing. Scrub and wipe away the residue, then rinse clean. Ideal for removing boot marks, asphalt resin, baked-on insects and melted plastic bags. Resealable applicator cap.

4 fl oz (118 ml) Bottle.

93600001	U.S.	\$8.95
93600069	International.	\$8.95

I. CHROME CLEAN & SHINE

Professional strength nonabrasive cleaner is formulated to ensure maximum shine on chrome-plated surfaces. The detergent-resistant formula is easy to apply and can be buffed to a bright, long-lasting finish. Can also be used to clean decorative brushed aluminum, brass and stainless steel surfaces.

4 oz (113 g) Container.

93600031	U.S.	\$9.95
93600082	International.	\$9.95

J. WINDSHIELD WATER REPELLENT

Approved for use on Harley-Davidson motorcycle windshields. Enhance visibility during wet weather riding. Reduces the surface tension of water, allowing the water to bead and dissipate from the windshield by the airflow during riding. The convenient dispensing container includes 10 disposable wipes for easy application of the treatment. You can repeat application of the treatment as necessary. Not recommended for use on face shields. Not for use as an anti-fog product.

93600032 10 Wipes. **\$7.95**

K. LCD SCREEN WIPES – INDIVIDUAL WIPES

Treated cloth safely cleans LCD touch screens. The soft disposable wipes quickly remove fingerprints and road grime from the screen to restore your clear view. The one-time use wipes are sealed in a convenient tear-open pouch so they stay clean and grit-free to avoid scratching the screen. Sold individually.

93600116 One Single-Use Wipe. **\$2.01**



E. WHEEL & TIRE CLEANER



F. DENIM PAINT CLEANER



G. SEAT, SADDLEBAG & TRIM CLEANER



H. BOOT MARK REMOVER



I. CHROME CLEAN & SHINE



J. WINDSHIELD WATER REPELLENT

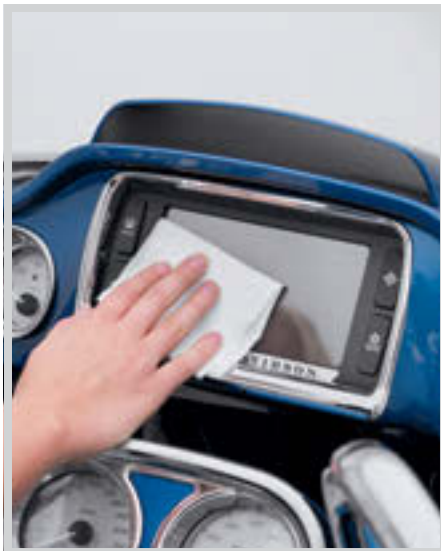

K. LCD SCREEN WIPES – INDIVIDUAL WIPES

Notice: The prices appearing in this catalog are the manufacturer's suggested retail prices. Actual retail prices may vary.

812 GARAGE

Surface Care – Detail

A. GLOSS DETAILER

This easy-to-apply mist produces the highest possible gloss finish in the shortest amount of time. Formulated to enhance luster and provide UV protection between waxes, this nonabrasive quick detailer can be applied to paint, clear coat, chrome, powder coat, windshields, vinyl and plastic. Gloss Detailer contains no waxes, silicones, oils or hydrocarbon solvents and will not remove Glaze™ Poly Sealant. Biodegradable.

16 fl oz (473 ml) Spray Bottle.

93600062 U.S. **\$9.95**

93600073 International. **\$10.95**

1 Gallon Bottle.

93600085 Global. **\$29.95**

Single-Use Wipe.

97401-10 One Single-Use Wipe. **\$1.51**



A. GLOSS DETAILER



A. GLOSS DETAILER – INDIVIDUAL WIPES

B. SCRATCH & SWIRL REPAIR

Formulated to remove fine scratches and swirl marks from gloss paint, this unique compound contains nonrigid abrasives that provide good initial leveling action on clear coat and become less aggressive while being buffed. This staging of grit size provides the benefits of a several step process in one convenient bottle and leaves your clear coat with a new bike shine. Biodegradable.

8 fl oz (236 ml) Bottle.

93600025 U.S. **\$7.95**

93600074 International. **\$7.95**

C. ENGINE BRIGHTENER

Make your engine look new again. Engine Brightener refreshes and rejuvenates tired wrinkle black finishes on engine cases, cylinder fins, covers or anywhere else the color has faded or lost its luster. Formulated with high-temperature silicon polymer, this detergent-resistant finish restorer cleans deep into the wrinkle black surface and “moisturizes” the finish to return the original satin sheen. Just spray it on, let it soak in and wipe away for a fresh look.

11 oz (311 g) Aerosol Can.

93600002 U.S. **\$15.95**

93600068 International. **\$15.95**

D. BLACK INNER FAIRING REJUVENATOR

Great for sun-rich environments, this Inner Fairing Rejuvenator brings back the deep black color on faded Original Equipment satin-black inner fairing surfaces. Just wipe on and buff off. An occasional application restores the luxurious matte finish and provides added UV protection. Can also be used on rubber and other black plastic components.

93600115 8 fl oz (236 ml) Bottle. **\$14.95**

E. GLAZE™ POLY SEALANT

Three products in one bottle. A durable, breathable, clear poly sealant with UV protection that protects against fading and the oxidizing effects of acid rain and harsh airborne pollutants. An ultrafine leveling agent that removes fine scratches and minor blemishes in clear coat finishes. And a cleaner tough enough to handle tar, tree sap, stains and pollutants. Glaze Poly Sealant is easy to apply and hand buff for a deep, reflective finish. For use on all chrome-plated and gloss painted surfaces. Can also be used to slow the natural aging process of Brass Collection components. Not for use on brake discs or denim, semi-gloss or wrinkle-finish surfaces. Biodegradable.

8 fl oz (236 ml) Bottle.

93600026 U.S. **\$7.95**

93600079 International. **\$7.95**



B. SCRATCH & SWIRL REPAIR



C. ENGINE BRIGHTENER



D. BLACK INNER FAIRING REJUVENATOR



E. GLAZE POLY SEALANT

Notice: The prices appearing in this catalog are the manufacturer's suggested retail prices. Actual retail prices may vary.



F. BLACK LEATHER REJUVENATOR



G. LEATHER PROTECTANT

F. BLACK LEATHER REJUVENATOR

Black Leather Rejuvenator puts new life back into faded black leather seats and saddlebags. To re-color and condition weathered leather, just clean the surface and apply the treatment with a Disposable Detailing Soft Cloth. Wipe off the excess, buff the leather surfaces to the desired shine, and your leather looks like new. For lasting weather protection, follow the application with H-D® Leather Protectant.

4 oz (113 g) Container.

93600033	U.S.	\$7.95
93600081	International.	\$7.95

G. LEATHER PROTECTANT

Leather Protectant offers the most effective weatherproofing and preservative action for leather saddlebags, tank panels, gear and apparel. Specially formulated for smooth, oil-tanned leather.

6 oz (170 g) Container.

93600034	U.S.	\$7.95
93600080	International.	\$7.95

H. BARE METAL POLISH

Professional strength micro-abrasive polish is formulated to remove oxidation and refurbish metal motorcycle parts that have lost their original finish. Recommended for use on polished aluminum or polished stainless steel surfaces that are not clear coated. Can also be used to polish Brass Collection components to a bright finish. Not for use on painted, chromed or plated surfaces or decorative brushed aluminum or stainless steel finishes.

4 oz (113 g) Container.

93600028	U.S.	\$9.95
93600083	International.	\$9.95

I. BARE ALUMINUM WHEEL PROTECTANT – INDIVIDUAL WIPES

Bare Aluminum Wheel Protectant provides superior corrosion control for bare aluminum surfaces by forming a protective polymeric coating. The long-lasting formula is detergent and UV-resistant and is compatible with Harley-Davidson® approved painted surfaces. Ideal for bare aluminum machined wheels. Should not be applied to mirror-polished surfaces or areas that will achieve operating temperatures greater than 300 degrees Fahrenheit.

93600063	One Single-Use Wipe.	\$5.95
-----------------	----------------------	---------------

J. WINDSHIELD CLEANER – INDIVIDUAL WIPES

Windshield Cleaner is approved for use on Harley-Davidson windshields and removes water spots and grime that can obstruct your view. Single-use disposable wipe reduces the chance of scratching the shield, and cleans better than the typical grit-laden gas station squeegee or paper towel.

93600067	One Single-Use Wipe.	\$1.51
-----------------	----------------------	---------------

K. TIRE LETTERING PEN

Enhance your tire sidewall lettering by applying White paint. Acrylic ester resin paint provides excellent water resistance with improved color and gloss retention. Pump action paint dispensing pen allows either outlining or filling the lettering. Tip can be shaped or trimmed to allow for customized paint flow.

98625	1/3 fl oz – White.	\$9.95
--------------	--------------------	---------------



H. BARE METAL POLISH



I. BARE ALUMINUM WHEEL PROTECTANT – INDIVIDUAL WIPES



J. WINDSHIELD CLEANER – INDIVIDUAL WIPES



K. TIRE LETTERING PEN

Notice: The prices appearing in this catalog are the manufacturer's suggested retail prices. Actual retail prices may vary.

814 GARAGE

Surface Care

A. HARLEY® WASH BUCKET

The perfect way to keep your bike clean and your garage organized. This handy 3.5 gallon cleaning bucket features a removable Grit Guard® insert that keeps sponges and wash mitts away from the dirt particles that settle to the bottom. The bucket is wrapped with a convenient clip-on apron that features clear vinyl pockets with mesh drains that are sized to fit Harley-Davidson® cleaning and detailing products (*sold separately*). The sturdy handle and snap tight lid make transportation and storage a breeze.

94811-10 **\$39.95**

B. FIREMAN STYLE HOSE NOZZLE

Wash your bike in style. The unique Fireman-Style hose nozzle features a large overhand lever for convenient operation. Just adjust the lever and the nozzle maintains the pressure flow – hands free. The spray head adjusts from a steady stream to a wide fan pattern and the soft rubber nose cone protects your bike's surfaces from accidental contact. The durable metal body won't rust or corrode and the soft-touch ergonomic grip is insulated for cold-water comfort. Standard-size garden hose fitting includes gasket.

93600016 **\$20.95**

C. WASH MITT

This premium quality, wool-blended wash mitt features extra dense pile for scrubbing power and durability. Machine washable, this mitt attains the perfect level of absorbency and has a Bar & Shield logo sewn into the cuff. Including a thumb for added dexterity, this mitt is custom designed to be used with either hand and made specifically for washing Harley-Davidson motorcycles.

94760-99 **\$13.95**

D. WHEEL AND SPOKE BRUSH

The perfect partner for Wheel & Tire Cleaner, this brush features soft, durable fibers attached to a base coated with polypropylene to prevent scratching. With a Bar & Shield logo branded into the handle, the brush has a cone shape for efficient cleaning and durable design that won't melt on hot surfaces.

43078-99 **\$15.95**



A. HARLEY WASH BUCKET



B. FIREMAN STYLE HOSE NOZZLE



C. WASH MITT



D. WHEEL AND SPOKE BRUSH

Notice: The prices appearing in this catalog are the manufacturer's suggested retail prices. Actual retail prices may vary.



E. CLEANING BRUSH KIT



E. CLEANING BRUSH KIT

Make every corner of your bike shine. This set of 3 wood-handled cleaning brushes helps you reach into the tightest places. The chamois brush gently scrubs in between engine fins or can be used after rinse to soak up hard-to-reach water. The reverse spiral brush is perfect for cleaning tire sidewalls or those hard-to-reach spaces elsewhere on your bike, and the soft mop brush will leave your chrome streak free. All brushes have vinyl-coated wires to prevent scratching.

94844-10

\$29.95

F. BUG EATER SPONGE

Tough on bugs but gentle on other surfaces. This easy-to-grip pad features a strong, flexible core laminated with double-sided cleaning surfaces. When paired with water and Bug Remover or Wheel & Tire Cleaner sprays, the textured orange surface helps break down and dissolve baked on bugs and road grime without scratching the surface below.

93600110

\$7.95



F. BUG EATER SPONGE



G. DISPOSABLE DETAILING SOFTCLOTHS – DISPENSER BOX

G. DISPOSABLE DETAILING SOFTCLOTHS – DISPENSER BOX

Now available in a pop-up dispenser box to keep cloths clean and handy. Rags often cause scratches in paint, but these Disposable Detailing Softcloths are made of special material specifically designed not to scratch paint while greatly reducing the amount of lint left behind during waxing and polishing. To avoid contamination, these disposable cloths come in a handy re-sealable pop-up dispenser box. Package contains 50 towels.

93600114

Dispenser Box with 50 Cloths.

\$15.95

H. MICROFIBER DETAILING CLOTH

Super soft and absorbent microfiber synthetic cloth is the multi-purpose choice for washing, cleaning or buffing. The cloth can be used wet or dry and is safe for use on all surfaces and finishes. This durable 16" square cloth is mildew-resistant and machine washable. Includes convenient storage container.

94663-02

\$9.95



H. MICROFIBER DETAILING CLOTH



I. SYNTHETIC DRYING CHAMOIS

I. SYNTHETIC DRYING CHAMOIS

Made of synthetic material that is safe for use on all surface finishes. Ensures extra absorbency without streaking. Stays soft and supple even when dry. Durable, mildew-resistant and machine washable. 12" x 21" chamois stores in a convenient container.

94791-01

\$9.95

J. DETAILING SWABS

Detail those hard-to-reach places. Plush cotton swabs are perfect for removing polish and wax residue from cracks and crevices, and the strong but flexible 8" shaft allows you to clean in hard to reach areas around your engine, pipes and more. Package contains 50 swabs.

93600107

\$8.95



J. DETAILING SWABS



Notice: The prices appearing in this catalog are the manufacturer's suggested retail prices. Actual retail prices may vary.

816 GARAGE

Surface Care

A. HARLEY® BIKE WASH KIT

Bike Wash Kit includes the essentials required to clean your bike.

- Sunwash® Bike Soap
- Bug Remover
- Wash Mitt
- Bug Eater Sponge
- Synthetic Drying Chamois
- Microfiber Detailing Cloth

93600056 **\$49.95**



A. HARLEY BIKE WASH KIT

B. HARLEY DETAIL & PROTECT KIT

Detail & Protect Kit includes the essentials to make your bike shine.

- Glaze™ Poly Sealant
- Gloss Detailer
- Chrome Clean & Shine
- Scratch & Swirl Repair
- Disposable Detailing Soft Cloths
- Microfiber Detailing Cloth
- Detailing Swabs

93600057A **\$54.95**



B. HARLEY DETAIL & PROTECT KIT

C. HARLEY TRAVEL CARE KIT

Everything you need to make your bike shine – except the water. Whether you are starting the ultimate biker's garage, or want to keep your ride clean on the road, the Harley® Travel Care Kit is your answer. The kit includes five 2 oz refillable bottles of proven Harley-Davidson® cleaning products. The kit features Sunwash Bike Soap cleaner, spray-on Bug Remover, fast-acting Wheel & Tire Cleaner, Glaze Poly Sealant, Gloss Detailer and a soft Microfiber Detailing Cloth. The complete kit fits easily in the compact reusable zip-closure bag so you can take it along for the ride or store it neatly in your garage.

93600007 Five 2 oz Bottles. **\$25.95**



C. HARLEY TRAVEL CARE KIT

D. SADDLEBAG STORAGE STAND

Never set your saddlebags on the ground again. This convenient folding rack holds Touring hard saddlebags while you wash or work on your bike and utilizes the bag's quarter-turn quick-disconnect fasteners to securely lock them in place. The strong, lightweight rack features 4 adjustable feet to level the stand and keep the bags off the ground. You can wash, dry, detail and re-install the bags with minimal handling. Stand accommodates both standard and extended hard saddlebags.

94778-10 **\$99.95**

Fits '95-'16 Touring models equipped with standard and extended-length saddlebags.



D. SADDLEBAG STORAGE STAND

E. HOG® BLASTER MOTORCYCLE DRYER

Dry your bike in minutes with the HOG® Blaster. This powerful dryer blows a stream of warm, dry, filtered air at 18,000 feet/minute, allowing you to cut your drying time up to 75%. The HOG Blaster reduces streaks and water spots because water can't hide in hard to reach places. No more annoying drips and runs when you move your bike. With an ergonomically friendly design for comfortable handling, the HOG Blaster features a durable all-steel outer shell, a 1.3 hp motor and a grounded electrical cord. Kit includes blower unit, flexible hose and 2 diffuser attachments. One-year manufacturer's warranty on blower unit.

94651-09 120V, Grounded 3-prong Plug. **\$124.95**
United States, Canada and Mexico.



E. HOG BLASTER MOTORCYCLE DRYER

Notice: The prices appearing in this catalog are the manufacturer's suggested retail prices. Actual retail prices may vary.

HARLEY-DAVIDSON® MOTORCYCLE COVERS

Welcome to the best-dressed list. Unlike a tarp and bungee cords, Harley-Davidson® Motorcycle Covers fight the effects of the elements and protect your bike's paint and finishes from the rough world around us. Whether your bike spends its time in a heated garage or on the driveway, we've got you covered.

ANTENNA ACCESS

Touring and Trike covers feature hook-and-loop opening at the rear to accommodate antennas.

WATER-RESISTANT SEAMS

Heavy-duty Indoor/Outdoor covers feature taped overlapping seams for water resistance.

MOISTURE REDUCTION

Weather-shielded vents or breathable materials promote air circulation and minimize corrosion during short or long term storage.

HEAT-RESISTANT PANELS

Indoor/Outdoor and Premium Indoor Covers feature heat-resistant panels that protect the cover from warm exhaust.

REFLECTIVE TRIM

High-visibility reflective trim makes a parked and covered bike more obvious.

BELLY STRAPS

Quick-release adjustable straps cinch the cover under the frame to reduce ballooning in the wind.

INTEGRATED STORAGE POUCH

After use, just fold the cover into the convenient integrated storage pouch.



CORSET-STYLE BACKBONE

Medium & large covers feature a cinching system that customizes the cover for best fit. Just pull the cord and cover adjusts to the bike's contours.



ADJUSTABLE HEM

Drawstring hem allows custom-tailored fit around the bike and eliminates the one-size-fits-some elastic cord.



LOCK ACCESS

Sewn-in grommets near the front wheel simplify the use of a cable lock or security chain (cable/lock not included).



COVER ALARM POCKET

Hidden pocket accepts optional battery-powered alarm. If the cover is disturbed, the 130-dB alarm is triggered.

818 GARAGE

	INDOOR	PREMIUM INDOOR	INDOOR/OUTDOOR	
				
MATERIAL	Polyester	Luxuriously Soft Microfiber	Heavy-Duty UV Resistant Diamond Pattern Polyester	
WATER-RESISTANT	—	—	✓	
HEAT PANEL	—	✓	✓	
ANTENNA ACCESS	—	✓	✓	
SECURITY FEATURES	Sewn in grommets for use of front wheel chain lock & hidden internal alarm pocket			
ADJUSTABILITY	Corset-Style Backbone & Adjustable Hem			
REFLECTIVE TRIM	✓	✓	✓	✓
INTEGRATED STORAGE POUCH	✓	✓	✓	✓
BELLY STRAP	✓	✓	✓	✓
H-D LOGO	✓	✓	✓	—
STREET™ & SPORTSTER®	Small 93100043 \$99.95	Small 93100042 \$149.95	Small 93100040 \$149.95	Small – Solid Black 93100041 \$139.95
V-ROD®, DYNA® & SOFTAIL®	Large 93100018 \$99.95	Medium 93100019 \$149.95	Medium 93100022 \$149.95	Medium – Solid Black 93100025 \$139.95
TOURING	Large 93100018 \$99.95	Large 93100020 \$159.95	Large 93100023 \$159.95	Large – Solid Black 93100026 \$149.95
TRIKE	Large 93100018 \$99.95	Extra-Large 93100021 \$189.95	Extra-Large 93100024 \$189.95	Extra-Large – Solid Back 93100027 \$179.95



Standard Feature

Notice: The prices appearing in this catalog are the manufacturer's suggested retail prices. Actual retail prices may vary.

*NOTE: H-D® motorcycle covers are not designed to be used while trailering. Using an H-D motorcycle cover while trailering may cause the cover to tear, possibly causing damage to the cover and motorcycle.



A. INDOOR/OUTDOOR MOTORCYCLE COVER – ORANGE/BLACK WITH HARLEY-DAVIDSON GRAPHICS



B. PREMIUM INDOOR MOTORCYCLE COVER



C. INDOOR MOTORCYCLE COVER

A. INDOOR/OUTDOOR MOTORCYCLE COVER*

Perfect for a bike that is exposed to the elements, this heavy duty cover is manufactured from diamond-pattern 300 Denier fade-resistant polyester and features taped seams for water resistance. The weather-shielded vents in the top of the cover promote air circulation to reduce moisture build-up and minimize corrosion during short or long term storage. Internal heat-resistant panels protect the cover from warm exhaust and an integrated storage pouch permits convenient packing when not in use. The cover skirt features front and rear adjustable drawstrings to cinch the cover around the bike and a convenient belly strap to reduce ballooning in the wind. Cover features a convenient opening near the front wheel for a security chain or cable and internal pockets that accept the optional Cover Alarm (P/N 69000038). Available in your choice of two-tone orange and black or inconspicuous plain black finish, the cover features reflective piping for added visibility.

Small. Fits XG, XL and XR models.

93100040	H-D Orange/Black.	\$149.95
93100041	Black.	\$139.95

Medium. Fits VRSC™, Dyna® and Softail® models.

93100022	H-D Orange/Black.	\$149.95
93100025	Black.	\$139.95

Large. Fits Touring and Freewheeler® models. Does not fit FLHXXX or FLHTCUTG models.

93100023	H-D Orange/Black.	\$159.95
93100026	Black.	\$149.95

Extra Large. Fits Trike models.

93100024	H-D Orange/Black.	\$189.95
93100027	Black.	\$179.95

B. PREMIUM INDOOR MOTORCYCLE COVER*

This luxuriously soft microfiber cover is ideal for short and long term indoor storage. The breathable microfiber material promotes air circulation to reduce moisture build-up and minimize corrosion. The cover's skirt features front and rear adjustable drawstrings to cinch the cover around the bike and a convenient belly strap to reduce ballooning in the wind. The cover features heat-resistant panels that protect the material from warm exhaust. Cover features a convenient opening near the front wheel for a security chain or cable and internal pockets that accept the optional Cover Alarm (P/N 69000038). The two-tone orange and black cover features reflective piping for added visibility and an integrated storage pouch for convenient packing when not in use.

Small. Fits XG, XL and XR models.

93100042	H-D Orange/Black.	\$149.95
-----------------	-------------------	-----------------

Medium. Fits VRSC, Dyna and Softail models.

93100019	H-D Orange/Black.	\$149.95
-----------------	-------------------	-----------------

Large. Fits Touring and Freewheeler models. Does not fit FLHXXX or FLHTCUTG models.

93100020	H-D Orange/Black.	\$159.95
-----------------	-------------------	-----------------

Extra large. Fits Trike models.

93100021	H-D Orange/Black.	\$189.95
-----------------	-------------------	-----------------

C. INDOOR MOTORCYCLE COVER*

Perfect for a bike that's parked indoors, this breathable polyester cover promotes air circulation to reduce moisture build-up and minimize corrosion during short or long term storage. The cover's skirt features front and rear adjustable drawstrings to cinch the cover around the bike and a convenient belly strap to reduce ballooning in the wind. The cover features a convenient opening near the front wheel for a security chain or cable and internal pockets that accept the optional Cover Alarm (P/N 69000038). The two-tone orange and black cover features reflective piping for added visibility and an integrated storage pouch for convenient packing when not in use.

Small. Fits XG, XL and XR models.

93100043	H-D Orange/Black.	\$99.95
-----------------	-------------------	----------------

Large. Fits Touring and Freewheeler models.

93100018	H-D Orange/Black.	\$99.95
-----------------	-------------------	----------------

*NOTE: H-D® motorcycle covers are not designed to be used while trailering. Using an H-D motorcycle cover while trailering may cause the cover to tear, possibly causing damage to the cover and motorcycle.



***WARNING:** Do not use while riding; could result in death or serious injury.

820 GARAGE

Motorcycle Covers & Storage Accessories

A. OASIS DAY COVER*

Keep your seat dry when you stop for the night. Lightweight and compact for travel, this easy-to-store cover rolls into the built-in bag. Made from soft micro-fiber, the black and orange water repellent fabric dries quickly for a quick get away. Hook-and-loop closures in the rear let you slip the cover over your antennas and the elastic bottom hem and footboard stirrups ensure a snug fit. The Harley-Davidson script and Bar & Shield logos prominently stand out on the fabric.

93100028 H-D Orange/Black. **\$109.95**
Fits Touring and Trike models equipped with Tour-Pak® luggage.



A. OASIS DAY COVER



B. RAIN COVER – SOLO SEAT

B. RAIN COVERS*

Featuring a handy storage sack, this black nylon, water-resistant, Cordura® cover packs easily and shelters your seat from the storm.

51638-97 Solo Seat. **\$29.95**
Fits H-D® solo seats (except XR and FLSTS).

51639-97 Two-Up Seat. **\$31.95**
Fits VRSC™, XG, XL, Dyna® and Softail® models with Two-Up Seats. Does not fit Touring and Trike models. Does not fit with Rider Backrests.

52952-97 Seat with Rider Backrest. **\$39.95**
Fits H-D Touring and Trike seats. Fits with accessory rider backrest. Includes rain cover for Tour-Pak® mounted passenger backrest.



B. RAIN COVER – TWO-UP SEAT



B. RAIN COVER – SEAT WITH RIDER BACKREST

C. MOTORCYCLE COVER ALARM

Protect your covered motorcycle from tampering. Self-contained alarm fits into the pocket on select H-D® Motorcycle Covers. The snap swivel clips to spokes, rotors or other fixed parts and the cord leads back to the alarm pin. If the cover is pulled off the bike, the pin is pulled, triggering the 130-dB alarm. Weatherproof alarm is powered by a replaceable 9V battery (not included).

69000038 **\$29.95**
Fits select H-D Motorcycle Covers with alarm pocket.



C. MOTORCYCLE COVER ALARM



D. COTTON WINDSHIELD STORAGE BAG

D. COTTON WINDSHIELD STORAGE BAG

This bag is constructed of breathable cotton material and is designed for a scratch-free storage area. The outside of the bag features an embroidered Bar & Shield logo to match the cotton cycle covers.

95982-98B **\$69.95**
Fits all Harley-Davidson® windshields.

E. HELMET HANGER

Proudly display your collection of helmets. Harley-Davidson Helmet Hangers keep your expensive helmet safe and out of the way. Designed to accommodate all types of helmets, these Helmet Hangers allow air to circulate inside to keep the liner fresh and dry. The rigid steel hooks feature a durable e-coated surface and soft rubber edges to protect the finish of the helmet. The wall-mount J-Hook design can be secured to a trailer wall, garage wall or most any flat surface. The universal S-Hook design hangs on doors, cubical walls and closet rods.

93100034 J-Hook. **\$24.95**



E. HELMET HANGER – J-HOOK



F. JIFFY STAND COASTER

F. JIFFY STAND COASTER

Designed for use beneath the jiffy stand, this polypropylene coaster prevents the stand from sinking into soft surfaces such as dirt, asphalt and grass.

94647-98 **\$5.95**
Fits motorcycles equipped with a sidestand.

*NOTE: H-D® motorcycle covers are not designed to be used while trailering. Using an H-D motorcycle cover while trailering may cause the cover to tear, possibly causing damage to the cover and motorcycle.



***WARNING:** Do not use while riding; could result in death or serious injury.

Notice: The prices appearing in this catalog are the manufacturer's suggested retail prices. Actual retail prices may vary.



**G. SERVICE COVER –
(LARGE FUEL TANK SHOWN)**



**G. SERVICE COVER –
(SPORTSTER FUEL TANK SHOWN)**



**G. SERVICE COVER –
(LARGE FRONT FENDER SHOWN)**



**G. SERVICE COVER –
(SMALL FRONT FENDER SHOWN)**

G. SERVICE COVERS*

Protect the finish on your tank and fenders while performing routine service on your motorcycle. These custom shaped covers feature an easy-to-clean black vinyl outer surface and a soft non-abrasive fleece inner liner. Fuel tank covers feature built-in magnets to prevent the cover from sliding, convenient mesh pockets to keep small parts from rolling away and a clear paperwork window for notes and instruction sheets. Fender covers feature soft elastic bands to keep the covers firmly in place. To complete the look, the cover features a nostalgic Harley-Davidson logo that will look great in any garage.

94640-08 Large Fuel Tank. **\$32.95**
Fits Dyna®, Softail®, Touring and Trike models.

94642-08 Sportster® 3.5 Gallon Fuel Tank. **\$31.95**
Fits XL models with 2.2 or 3.3 gallon fuel tank.

94645-08 Sportster 4.5 Gallon Fuel Tank. **\$32.95**
Fits XL models with 4.5 gallon fuel tank. Also fits XG models.

94641-08 Large Front Fender. **\$31.95**
Fits '12-'16 FLD, '86-'17 FL Softail (except FLS and FLSS), '18-later FLDE, FLHC and FLHCS, and most Touring and Trike models.

94643-08 Small Front Fender. **\$29.95**
Fits most XG, XL, XR, Dyna and '84-'17 FX Softail models.

H. REMOTE CONTROL GARAGE DOOR OPENER KIT

Operate your automatic garage door opener without leaving your motorcycle seat or fumbling in your pocket for the remote control. Compatible with most brands of automatic openers, this kit allows you to operate your door by cycling the bike's high-beam switch. The hidden transmitter splices into your bike's wiring harness and is powered by your vehicle battery, so there are no transmitter batteries to replace. When your key is switched off the transmitter is disabled, providing added garage security if you park your bike outside. The signal is sent to the in-garage receiver that plugs into a standard 110-volt outlet and is wired to the automatic opener. The receiver's rolling code technology provides additional security. Kit includes one transmitter and one receiver. Individual components are available to equip additional motorcycles and garages.

91558-01B Complete Kit. **\$139.95**

Fits '02-'17 VRSC™, '15-later XG, '94-later XL, '08-'13 XR, '96-'17 Dyna, '96-later Softail, and '94-later Touring and Trike models. '14-later XL, '12-'17 Dyna and '11-'17 Softail models require separate purchase of Electrical Connection Kit P/N 72673-11. '14-'16 Touring and Trike models require separate purchase of Electrical Connection Kit P/N 69200722. '18-later Softail and '17-later Touring and Trike models require separate purchase of Electrical Connection Kit P/N 69201599A. '15-later XG models require separate purchase of P/N 72136-94GY, 72156-94 and Qty. 4 72195-94. Not compatible with Chamberlain®/Liftmaster® MyQ® or Sears® Craftsman AssureLink™ garage door openers.

1. Remote Control Garage Door Opener Transmitter

This kit allows owners of the Remote Garage Door Opener P/N 91558-01B to equip each of their Harley-Davidson motorcycles with a remote transmitter.

91561-01B **\$74.95**

For use with Remote Control Garage Door Opener Kit P/N 91558-01B. '15-later XG models require separate purchase of P/N 72136-94GY, 72156-94 and 4x 72195-94. '14-later XL, '12-'17 Dyna and '11-'17 later Softail models require separate purchase of Electrical Connection Kit P/N 72673-11. '14-'16 Touring and Trike models require separate purchase of Electrical Connection Kit P/N 69200722. '18-later Softail and '17-later Touring and Trike models require separate purchase of Electrical Connection Kit P/N 69201599A.

2. Remote Control Garage Door Opener Receiver

This additional receiver permits the owner of the Remote Garage Door Opener P/N 91558-01B to operate more than one garage door opener from a single transmitter.

91562-01 **\$74.95**

For use with Remote Control Garage Door Opener Kit P/N 91558-01B. Not compatible with Chamberlain/Liftmaster MyQ or Sears Craftsman AssureLink garage door openers.

*NOTE: H-D® motorcycle covers are not designed to be used while trailering. Using an H-D motorcycle cover while trailering may cause the cover to tear, possibly causing damage to the cover and motorcycle.



***WARNING:** Do not use while riding; could result in death or serious injury.



H. REMOTE CONTROL GARAGE DOOR OPENER KIT

Notice: The prices appearing in this catalog are the manufacturer's suggested retail prices. Actual retail prices may vary.

822 GARAGE

H-D® Detachables™ Storage

A. DETACH DEPOT WALL RACK

Declutter your garage! Detachable windshields, backrests, luggage racks and Tour-Pak® luggage increase the versatility of your bike and allow you to equip your motorcycle for today's ride. Add the accessories to the bike when you need them, and pop them off when you don't. But what do you do with the H-D® Detachables™ when they are not on the bike? The Detach Depot Wall Rack offers an off-the-floor, secure storage place for your detachable accessories. You no longer need to find acres of shelf space or worry about tripping over your detachable components. This heavy-duty Detach Depot Wall Rack can be mounted to any wall, and the 16" on-center design lets you mount it securely to the studs. The rack features 5 coated rods that can be positioned in a wide variety of adjustable mounting slots. Just install the rods in the appropriate location, tighten them down and click your detachable accessories in place. Adjustable rods can accommodate almost any combination of accessories. Kit includes black-finished side panels, 5 coated rods, decorative end caps and all necessary mounting hardware.

93100005 **\$199.95**

For use with Harley-Davidson® Detachables and HoldFast™ products including Tour-Pak Mounting Racks, Sissy Bars, Luggage Racks, Rider Backrests and H-D Detachables-style Windshields. Quick-Release style Windshields and Rider Backrests require separate purchase of auxiliary mount kits.



A. DETACH DEPOT WALL RACK

B. DETACH DEPOT QUICK-RELEASE WINDSHIELD MOUNTS

Required for installation of Quick-Release Windshields on Detach Depot Wall Rack. Stepped conical mounts slip onto the Detach Depot Wall Rack's adjustable rods and allow the clamp-style quick-release windshield mounts to firmly lock in place. Kit includes 2 stepped mounts.

93100015 **\$24.95**

For use with Harley-Davidson Quick-Release Windshields (except XG) and Detach Depot Wall Rack P/N 93100005.



B. DETACH DEPOT QUICK-RELEASE WINDSHIELD MOUNTS

C. DETACH DEPOT RIDER BACKREST MOUNT

Store your Touring Rider Backrest safely in your garage when it's not on your bike. This compact bracket mounts to the Detach Depot Wall Rack side plate and allows you to hang the rider backrest pad in a convenient location. Kit includes mounting bracket and required hardware.

93100016 **\$24.95**

For use with Harley-Davidson Touring and Trike Rider Backrest and Adjustable Rider Backrest Kits and Detach Depot Wall Rack P/N 93100005.



C. DETACH DEPOT RIDER BACKREST MOUNT



SOFTAIL® H-D DETACHABLES



ROAD KING® CLASSIC H-D DETACHABLES

Notice: The prices appearing in this catalog are the manufacturer's suggested retail prices. Actual retail prices may vary.



D. CRUISER CRADLE WHEEL CHOCK



E. CRUISER CRADLE TRAILER ADAPTER KIT



F. CRUISER CRADLE WHEEL CHOCK - TRAILER ONLY VERSION



G. CRUISER CRADLE UNIVERSAL E-TRACK ADAPTER KIT (SHOWN WITH WHEEL CHOCK)



H. MOTORCYCLE SERVICE LIFT

D. CRUISER CRADLE WHEEL CHOCK

This sturdy aluminum wheel chock will hold your bike securely on the ground, on a trailer or in the back of a pickup truck. Sized to fit most motorcycles, this wheel chock will keep your bike upright while you are storing, transporting or working on your bike.

The lightweight, folding wheel chock is easy to transport. Use it on the driveway when you are washing your bike or, when equipped with the optional Trailer Adapter, the versatile wheel chock can be easily moved to a trailer or the back of a pickup truck. Just two tie-down straps are required to hold the bike in place. And because you don't need to over-tighten the straps, you won't damage sensitive suspension parts and handlebar bushings.

92900001 \$264.95
For use with models with vehicle weight up to 3000 lb (1360 kg) and front or rear wheel size of 14" to 22" (355-560mm) rim diameter and 3.15" to 8.66" (80mm-220mm) nominal wheel width.

E. CRUISER CRADLE TRAILER ADAPTER KIT

Engineered to simplify installation of Cruiser Cradle Wheel Chock on many trailers. Simply mount the low profile kit to the floor of your trailer and the Cruiser Cradle can be attached in seconds, without tools.

92900002 \$34.95
For use with Cruiser Cradle Wheel Chock P/N 92900001 on trailer applications.

F. CRUISER CRADLE WHEEL CHOCK - TRAILER ONLY VERSION

Sized to fit most motorcycles, this wheel chock will keep your bike upright while you are transporting or working on your bike. Just two tie-down straps are required to hold the bike in place. The Trailer-Only chock can be removed from the trailer in seconds with four wing nuts or the optional E-Track Adapter and can be folded down when not in use. Includes all brackets and hardware to mount a trailer or lift table.

92900042 \$199.95
For use with models with vehicle weight up to 3000 lbs (1360 kg) and front or rear wheel size of 14" to 22" (355-560mm) rim diameter and 3.15" to 8.66" (80mm-220mm) nominal wheel width.

G. CRUISER CRADLE UNIVERSAL E-TRACK ADAPTER KIT

You can adjust the position of the chock anywhere along the E-Track for maximum flexibility in positioning a motorcycle and the chock can be adjusted side-to-side between 27" and 43" wide. The Universal E-Track Adapter Kit includes all the necessary hardware and including a Boomerang Bar for added Wheel Chock stability. Ratchet tie-downs are required for transporting the motorcycle.

92900043 \$129.95
For use with Cruiser Cradle Wheel Chock P/N 92900001 or 92900042 on trailer applications.

H. MOTORCYCLE SERVICE LIFT

The 1,100 capacity lift can raise any 2-wheel Harley® model 16.9" from the floor. The lift features 2 fixed and 2 swivel heavy duty wheels and a removable T-handle for easy maneuverability. Kit includes lift and 2 tie-down straps. Not available for sale in - Europe, Middle East and Africa.

92900004 \$299.95
Fits Harley-Davidson® V-Twin models (except Trike and models equipped with a Sidecar). Softail® models require Frame Protector Kit P/N 94675-99, Twin Cam-equipped Dyna® models require Adapter Kit P/N 98965-99, both sold separately.

Also available:

FRAME PROTECTORS (not shown)

Use these Frame Protectors to protect the underside of your motorcycle when using any lift. A must for Softail models to provide the clearance necessary to keep lift pressure on the frame and not the shock absorbers. Universal and customizable to fit any V-Twin Harley-Davidson motorcycle. Sold in pairs.

94675-99 Fits all 1.25" frame tubes. **\$25.95**

Also available:

MOTORCYCLE SERVICE LIFT ADAPTOR KIT FOR DYNA® TWIN CAM MODELS (not shown)

Provides the necessary clearance of the oil tank that allows the Motorcycle Service Lift P/N 92900004 to be used on '99-'17 Dyna models equipped with a Twin Cam engine.

98965-99 \$25.95

824 GARAGE

Motorcycle Tie-Downs

A. HARLEY-DAVIDSON® 1.5" GRADUAL RELEASE RATCHET TIE-DOWN STRAPS

600 lbs Working Load – 1.5" x 66"

These heavy duty ratchet straps provide maximum tensioning power and a higher working load capacity with the added benefit of being able to release the tension one click at a time. The ratchet is built with a comfortable molded grip handle and a dual-direction reversing drive that permits the spindle to rotate backwards releasing tension until it reaches 60 lbs. This option helps eliminate the "snap back" release common with most standard ratchet designs under heavy load and also permits the even tensioning of straps without having to release all of the webbing and start over. The strap also features heavy duty 6,000 lbs abrasion resistant Nylon webbing, a built in Soft Hook with vinyl coated full size "S" hook on the fixed end and an large closed end carabiner hook on the adjustable end to keep it hooked securely during the tie-down process. Sold in pairs.

94706-10 **\$69.95**
Ratchet Straps with Integrated Soft Hook.



A. 1.5" GRADUAL RELEASE RATCHET TIE-DOWN STRAPS



B. HARLEY-DAVIDSON 1.25" RATCHET TIE-DOWN STRAPS

B. HARLEY-DAVIDSON 1.25" RATCHET TIE-DOWN STRAPS

400 lbs Working Load – 1.25" x 78"

These 1.25" Harley-Davidson® Tie-Downs have a 1,200 lb capacity and feature Harley-Davidson scripted webbing with a loop handle for easy pulling. Vinyl-coated hooks feature spring loaded one-way wire loop gates that hold the hook in position, simplifying initial tie-down setup. Harley-Davidson Ratchet Tie-Down Straps feature lever-action ratchets for use when greater tensioning power is needed. Straps are also available with integrated soft hooks that are designed to keep the coated hard hooks away from delicate surfaces. Sold in pairs.

94704-10 **\$49.95**
Ratchet Straps with Integrated Soft Hook.



C. HARLEY-DAVIDSON FLEECE SOFT HOOKS



D. HARLEY-DAVIDSON 18" SOFT HOOKS

C. HARLEY-DAVIDSON FLEECE SOFT HOOKS

400 lbs Working Load – 1.25" x 18"

These 18" Soft Hooks are designed to keep ratchets, hooks and buckles away from delicate surfaces. The soft synthetic sheepskin cover cushions the surface and protects handlebars, triple trees and other tie-down points from scratches and abrasion. Each soft hook has a capacity of 2,400 lb. Sold in pairs.

93100017 **\$15.95**

D. HARLEY-DAVIDSON SOFT HOOKS

400 lbs Working Load – 1.25" x 18"

These Harley-Davidson 18" Soft Hooks keep ratchets and buckles away from delicate surfaces. Each soft hook has a capacity of 2,400 lb. Sold in pairs.

94705-10 **\$11.95**

E. HOG TIES® SOFT HOOKS

600 lbs Working Load – 1.5" x 18"

Wider and stronger, Hog Ties® Soft Hooks are designed to be used in conjunction with standard Hog Ties Straps to keep hooks from direct contact with handlebars, fairings, brake lines, wiring and painted surfaces. Secure to bike then secure tie-down hook to opposite end. Made with 6,000 lbs Nylon webbing. Sold in pairs.

94650-98 **\$10.95**



E. HOG TIES SOFT HOOKS

F. ANCRA® RAT-PACK RATCHET STYLE TIE-DOWN STRAPS

400 lbs Working Load – 1" x 66"

The original ratchet tie-down for motorcycles locks secure and provides the added tension needed to secure bikes and ATVs for longer hauls. Straps feature a wider grip ratchet handle, 4,500 lbs abrasion resistant nylon webbing, full size vinyl coated S hooks on fixed ends and non-coated steel S hooks on the adjustable ends. Sold in pairs.

98187-90T **\$37.95**



F. ANCRA RAT-PACK RATCHET STYLE TIE-DOWN STRAPS

Notice: The prices appearing in this catalog are the manufacturer's suggested retail prices. Actual retail prices may vary.

GARAGE 825

Motorcycle Locks

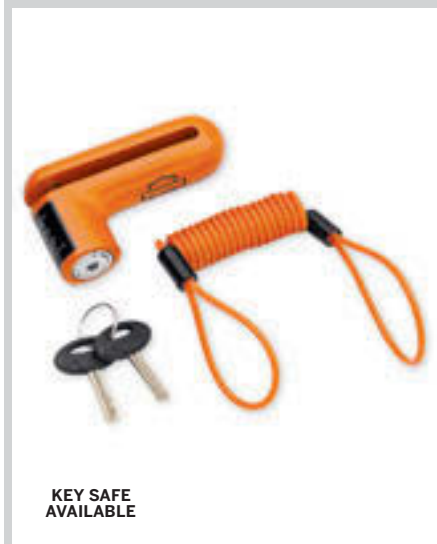

KEY SAFE
AVAILABLE

G. DISC BRAKE LOCK AND REMINDER CORD – ORANGE

G. DISC BRAKE LOCK AND REMINDER CORD^{1*}

Designed to prevent roll-away theft, this lock provides security protection and resists cutting and chisel attacks. Hardened drop-forged steel lock features a dual-reinforced high-security disc-style cylinder and blade-style key. The sleek and compact design is available in mirror chrome or in a bright orange finish for maximum visibility. Kit includes 2 blade-style keys and a high-visibility reminder cord that loops from the lock to the handlebar as a visual indication that your lock is still engaged. Key registration and replacement service is available.

Fits front brake rotor on '83-later models, except those with 19-inch laced front wheels. On VRSC™ models, fits on rear brake rotor, does not fit front brake rotor on models equipped with solid disc wheels.

94873-10 Orange. **\$49.95**

Also available:

LOCK REMINDER CORD¹

Remember to remove your Disc or Fork Lock before beginning your ride with this high-visibility Reminder Cord. Flexible, coiled, bright orange cord loops from external lock to handlebar, acting as a visual indication that your lock is still engaged.

46318-04 **\$4.95**

H. SHACKLE LOCK KIT^{1*}

Secure your brake disc or sprocket. This lock features a fully removable 14mm shackle with a large inside diameter to simplify the capture of chain links and cable loops. The high-security double deadbolt design and anti-float disc lock cylinder is tough to defeat and the soft nylon coating on the shackle and lock protects your bike's finish. The blade-style key slot is hidden behind a sliding dust cover for weather protection and the kit includes a lighted key for nighttime locking. The bright orange color of the lock and the handy reminder cord provides visibility to the user and added theft deterrence. When not in use, the lock and cord can be stored in the compact ballistic nylon pouch with belt clip. Kit includes lock, two standard keys, one lighted key, coiled reminder cord and storage pouch.

- Includes Key Safe program that allows you to order keys if you lose them.
- Optional Anti-Theft protection that will pay up to \$750 if your bike is stolen.
- Thatcham Category 3 Approved.

94868-10 **\$59.95**



KEY SAFE
AVAILABLE

H. SHACKLE LOCK KIT

I. BAR & SHIELD LOGO PADLOCK¹

Classic round-body lock is perfect for use as a fork lock, or to secure protective cables or chains. This high-security lock features a tough case-hardened boron alloy shackle and easy-to-operate quarter-turn five-pin tumbler cylinder, housed in a beautiful chrome-plated lock body with textured surfaces and embossed Bar & Shield logo. Kit includes 2 keys.

45737-72A **\$22.95**



I. BAR & SHIELD LOGO PADLOCK

J. DOUBLE LOOPED SECURITY CABLE^{1,2}

This handy 7' x 10mm Double Looped Cable is very versatile. The vinyl-covered braided cable is flexible, and can be used to lock equipment to your bike. Loop it through the sleeve of your jacket and the strap of your helmet, lock it to the bike, and feel free to walk away unencumbered. The bright orange swage covers provide greater visibility for added theft deterrence, and the hook-and-loop strap lets you tie the coiled cable for convenient storage. Cable length: 7.0'.

94871-10 **\$12.95**



J. DOUBLE LOOPED SECURITY CABLE



¹WARNING: Remove lock before operating motorcycle. Failure to remove lock could result in death or serious injury.



²WARNING: Chain or cable is to be used as a theft deterrent only. Use for towing, lifting, or any other purpose could result in death or serious injury.

***KEY SAFE** registration and replacement service is provided by the lock manufacturer. Information is included in the product packaging.

Notice: The prices appearing in this catalog are the manufacturer's suggested retail prices. Actual retail prices may vary.

826 GARAGE

Motorcycle Locks

A. NOOSE CHAIN AND SHACKLE LOCK KIT^{1,2*}

Maximum protection for your motorcycle. This high-security Noose Chain and Lock features a 12mm triple heat treated boron manganese 6-sided link steel chain with cinch ring for securing your bike to stationary objects. Put the chain around a post, slip the chain through the ring, and cinch it tight. Then loop the nylon-web covered chain through the frame or wheels of the bike and lock it up tight. The lock features a fully removable 14mm shackle, a double deadbolt design for added security, a high-security lock cylinder with anti-float discs and nylon molded dust cover, and a lighted key for nighttime locking. The orange color gives the lock greater visibility for added theft deterrence. Security chain length: 4.25'.

- Includes Key Safe program that allows you to order keys if you lose them.
- Optional Anti-Theft protection that will pay up to \$1,000 if your bike is stolen.
- Thatcham Category 3 Approved.

94869-10

\$124.95



KEY SAFE
AVAILABLE

A. NOOSE CHAIN AND SHACKLE LOCK KIT

B. H-D® 20MM SUPER HARD WIRE CABLE LOCK^{1,2*}

This tempered steel cable lock features a smooth vinyl cover and a soft molded lock head to protect the frame and wheel from scratches. The braided and twisted cable offers improved cut resistance, and the integrated lock features a snap-shut cylinder with quarter-turn key movement. Orange highlights improve visibility for added theft deterrence. Kit includes 2 blade-style keys. Key Safe registration and replacement service is available. Cable length: 6.0'.

46089-98A

\$64.95



KEY SAFE
AVAILABLE

B. H-D 20MM SUPER HARD WIRE CABLE LOCK

C. UNIVERSAL MOUNT HELMET LOCK¹

To limit grab-and-run theft, just unlock the hinged clasp, hang your helmet by its strap, and relock with the included key. Your helmet is held securely in place. In addition, hanging your helmet reduces the risk of impact damage if the helmet slipped off the seat or the handlebar. Designed to be installed to .875" to 1.25" diameter tubing engine guards, saddlebag guards and frame tubes, the Helmet Lock is secured to the bike with tamper-proof hardware that cannot be easily removed. Note: Do not use lock when vehicle is in motion. Helmet Lock should only be used when motorcycle is parked and locked. Duplicate keys are not available.

45732-86

\$27.95

Fits all models. All '02-'17 VRSC™, '15-'17-later XG and '04-later XL and XR models require installation of engine guard.



C. UNIVERSAL MOUNT HELMET LOCK

D. HARLEY-DAVIDSON® HELMET LOCK¹

This carabineer-style universal helmet lock protects your helmet, jacket or bag from casual grab-and-go theft. The lock is small enough to fit into your pocket, but big enough to fit around most any handlebar or engine guard (1.5"/38mm max). No keys are required. Simply set your own 4-digit code, slip the carabineer through your helmet D-ring, and close the outward-opening lock. The aluminum and zinc alloy carabineer is covered with a tough rubber coating to protect the surrounding finishes.

5220003

\$24.95

E. HARLEY-DAVIDSON HELMET/JACKET SECURITY CABLE²

This handy cable is a great complement to the Harley-Davidson® Helmet Lock. Slide one end through your jacket sleeve or luggage, hook the loops at the end of the cable onto the Helmet Lock and attach it to your bike. And, if your helmet does not have D-rings, you can pass the cable through your helmet's chin piece, loop the ends through your Helmet Lock and lock it to your bike. Now your jacket, luggage and helmet are locked to your bike. When you're finished, it will recoil back to its original length and will slip easily into your pocket. The cable is made from 3mm thick nickel plated steel cable, is only 4.5 inches (11cm) long when coiled, stretches up to 6ft (180 cm) and has a load capacity of 200 lbs (100 kg).

52200004

\$12.95



D. HARLEY-DAVIDSON HELMET LOCK



E. HARLEY-DAVIDSON HELMET/JACKET SECURITY CABLE



¹WARNING: Remove lock before operating motorcycle. Failure to remove lock could result in death or serious injury.



²WARNING: Chain or cable is to be used as a theft deterrent only. Use for towing, lifting, or any other purpose could result in death or serious injury.

*KEY SAFE registration and replacement service is provided by the lock manufacturer. Information is included in the product packaging.



F. LOCKING H-D DETACHABLES LATCH KIT – CHROME

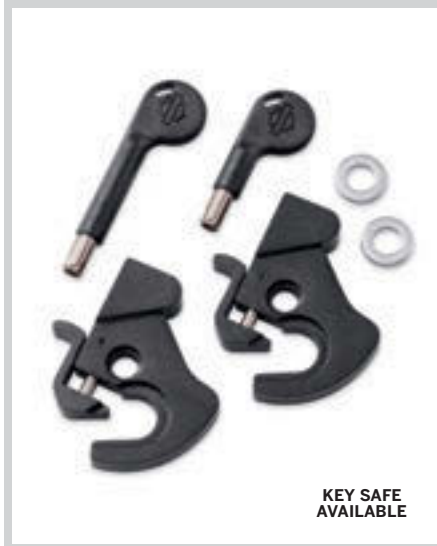

F. LOCKING H-D DETACHABLES LATCH KIT – BLACK

KEY SAFE AVAILABLE

F. LOCKING H-D® DETACHABLES™ LATCH KIT

This unique lock replaces the cam-lock on your Harley-Davidson® Detachables™ accessories, providing additional security and peace-of-mind when parking your vehicle. Kit includes two extended-reach barrel-style keys for easy access to the lock. Key registration and replacement service is available. Sold in pairs.

Fits all models equipped with detachable Sideplates, Racks and Tour-Pak® Luggage Carriers (except '18-later Softail® models with HoldFast™ racks and uprights or '09-later Touring models equipped with detachable Solo Tour-Pak Rack).

90300086	Black.	\$74.95
90300087	Chrome.	\$79.95

G. HOLDFAST™ LOCKING LATCH

Secure your valuables. This locking system allows you to protect your HoldFast™ Sissy Bar, Luggage Rack or Tour-Pak Mounting Rack from theft, providing security and peace of mind when parking your vehicle. The kit includes (2) keys and (1) locking mechanism

Fits '18-later Softail models equipped with HoldFast detachable Sissy Bar, Luggage Rack or Solo Tour-Pak Mounting Rack.

52300513	Chrome.	\$54.95
52300514	Black.	\$54.95

Fits '18-later Softail models equipped with HoldFast detachable Two-Up Tour-Pak Mounting Rack.

52300518	Chrome.	\$54.95
52300519	Black.	\$54.95



G. HOLDFAST LOCKING LATCH – CHROME



G. HOLDFAST LOCKING LATCH – BLACK

H. UNIVERSAL SADDLEBAG LOCK KIT

Keep the contents of your existing soft-sided saddlebags safe from the grab-and-go thief. This unique kit features two extra-small barrel locks that can replace existing saddlebag snaps to perform double duty as locks or as snaps when you don't need to lock your bags. Can be keyed to match your barrel-style ignition key. Sold in pairs.

Fits most soft-sided leather and vinyl saddlebags. Does not fit FLHRC and FLHRS.

90300003	Keyed To Match.	\$59.95
90300017	Random Key Code.	\$49.95

I. LOCKING QUICK-RELEASE WINDSHIELD CLAMP

Protect your investment. This Locking Quick-Release Windshield Clamp secures your windshield from grab-and-run theft, giving you peace of mind when you have to leave your bike unattended. The chrome-plated Locking Clamp replaces one of the Original Equipment windshield clamps, and features a push-button lock with a mini barrel-style key for easy removal. Kit includes one locking clamp and two matching keys.

57400006 39mm. **\$41.95**
Fits '88-later XL (except '16-later XL1200CX and XL1200X) and '91-'05 Dyna® models (except FXDWG) equipped with Quick-Release style windshields.

57400007 41mm. **\$41.95**
Fits '93-'05 FXDWG and '88-'15 FXS, FXST, FXSTB and FXSTC models equipped with Quick-Release style windshields.

57400008 49mm. **\$41.95**
Fits '02-'10 VRSCA and VRSCAW, '04-'05 VRSCB, '07 VRSCX, '16-later XL1200X, '06-'17 Dyna (except FLD) '18-later FXBB, FXBR, FXBRS and FXLR models equipped with Quick-Release style windshields.



H. UNIVERSAL SADDLEBAG LOCK KIT



I. LOCKING QUICK-RELEASE WINDSHIELD CLAMP

Notice: The prices appearing in this catalog are the manufacturer's suggested retail prices. Actual retail prices may vary.

828 GARAGE

Security Systems

A. H-D® SMART SECURITY SYSTEM – '07-LATER MODELS

The H-D® Smart Security System offers automatic self-arming and hands-free disarming for vehicle electronic security functions for your '07-later Harley® motorcycle. The Hands-Free Fob communicates directly on its own unique and individualized frequency with the Hands-Free Security Module and Antenna. Attach the Hands-Free Fob to your vehicle ignition key ring. As you upright your vehicle or switch the ignition on, the Hands-Free Fob will communicate the Security System "disarm" command allowing you to start your vehicle. After riding your vehicle, park and switch the ignition off with your key. Within 5 seconds the Security System will automatically self-arm, disabling your vehicle starter, ignition and electronic fuel injection (EFI). The Smart Security System includes: Hands-Free Security Module (Integrated Security Sensor and Turn Signal Module or Body Control Module), 2 Hands-Free Fobs, Antenna Module, Antenna Harness and Antenna Mount (Dyna® models).

Also available:

H-D SMART SECURITY SYSTEM HANDS-FREE FOB

Replacement/Additional Hands-Free Fob.

68926-07 \$49.95
Fits '07-'16 models (except '16 CVO™) equipped with H-D Smart Security System. Requires activation. See your Harley-Davidson® dealer.

90300111 \$44.95
Fits '17-later XL, Dyna, Softail®, Touring and Trike models equipped with H-D Smart Security System. Does not fit Japan models. Dealer installation required.

90300117 \$49.95
Fits '17-later XG models equipped with H-D Smart Security System. Requires activation. See your Harley-Davidson dealer.

B. H-D FACTORY SECURITY SYSTEM – '06-EARLIER MODELS

Equip your '06-earlier Harley-Davidson® VRSC™, Sportster®, Dyna, Softail or Touring model with the security system designed and approved by The Harley-Davidson Motor Company.

When armed, the Security System disables the starter and ignition while monitoring the electrical system and vehicle motion with adjustable sensitivity. Minor disturbances trigger a momentary warning; major ones, an unbroken thirty-second alarm, after which the Security System returns to monitoring. A distinctive four-way flasher pattern is the alarm signal. An optional self-powered Smart Siren Kit adds a piercing scream that sounds even if the battery cable is cut.

The Security System is armed and disarmed with a remote control waterproof key fob utilizing state-of-the-art rolling code technology. If the key fob is not available, the rider may arm or disarm the system by keying a previously entered personal code on the turn signal switches. Kit includes 1 Key Fob.

Also available:

REPLACEMENT/ADDITIONAL REMOTE CONTROL WATERPROOF KEY FOB

68926-00 \$49.95
Fits '00-'06 models equipped with H-D Factory Security System, North America. Requires activation. See your Harley-Davidson dealer.

68927-00 \$49.95
Fits '00-'06 models equipped with H-D Factory Security System, International (except Japan). Requires activation. See your Harley-Davidson dealer.

Also available:

LITHIUM REPLACEMENT BATTERY – 3 VOLT

Long-lasting, replaceable lithium coin-type battery for use in LED Temperature Dipsticks with Lighted LED Readout, Digital Touring Suspension Air Pump P/N 54000033 and Security Hands-Free Key Fob.

66000107 \$3.95
CR2032 3V Lithium Replacement Battery.



A. H-D SMART SECURITY SYSTEM – '07-LATER MODELS



**A. H-D SMART SECURITY SYSTEM – '07-LATER MODELS
(41000021E & 41000087D SHOWN)**



**A. H-D SMART SECURITY SYSTEM – '07-LATER MODELS
(68200-07A, 68207-07A & 91684-08A SHOWN)**



**B. H-D FACTORY SECURITY SYSTEM – '06-EARLIER MODELS
(68200-00D & 68207-00D SHOWN)**

Notice: The prices appearing in this catalog are the manufacturer's suggested retail prices. Actual retail prices may vary.

C. H-D® SECURITY SYSTEM SMART SIREN II

If your bike is equipped with an Original Equipment or accessory H-D® Smart Security System, this Smart Siren provides added security and convenience in one. The Harley-Davidson® Smart Siren II combines the functionality of the smart siren and pager transmitter into one easy-to-install unit. Featuring a built in back-up power supply, the siren and transmitter functions will continue to operate even if the wires are cut or the vehicle battery is disconnected. When combined with the Pager Receiver II (sold separately), the integrated FM transmitter can warn of tampering up to 1/2 mile away. Smart Siren II features an enhanced sound chamber, a redesigned internal battery access cover, and ultra low power consumption during the standby mode. When activated, the Security System Fob arm and disarm commands are confirmed with a blink feature and '07-later models can be programmed to emit a chirp. Smart Siren II is certified for use in North America.

Also available:

SMART SIREN BATTERY REPLACEMENT KIT (not shown)

Replacement Battery Kit for Harley-Davidson Factory Security System Smart Siren includes replacement nickel metal hydride battery and instructions.

69309-10 \$15.95



C. H-D SECURITY SYSTEM SMART SIREN II

Notice: The prices appearing in this catalog are the manufacturer's suggested retail prices. Actual retail prices may vary.

H-D SECURITY SYSTEMS, NORTH AMERICA

Model Family	Model Year	Security System	Smart Siren II Kit**
VRSC™ (except VRSCF)	2007-2017	68207-07A \$339.95	68328-06A \$94.95
VRSCF	2009-2017	91684-08A \$339.95	68328-06A \$94.95
VRSC (except VRSCR)	2002-2006	68200-00D \$299.95	68328-06A \$94.95
VRSCR	2006	68207-00D \$299.95	68328-06A \$94.95
Trike	2009-2013	68200-07A \$339.95	68328-06A \$94.95
Touring and Trike	2014-later	41000087E \$359.95	68328-06A \$94.95
Touring	2007-2013	68200-07A* \$339.95	68328-06A \$94.95
Touring	2002-2006	68200-00D* \$299.95	68328-06A \$94.95
Touring	2000-2001	68200-00D* \$299.95	68317-06A \$129.95
Dyna®	2012-2017	41000087E \$359.95	68328-06A \$94.95
Dyna	2007-2011	68207-07A \$339.95	68328-06A \$94.95
Dyna	2004-2006	68207-00D \$299.95	68328-06A \$94.95
Dyna	2000-2003	68200-00D \$299.95	— —
Softail®	2011-later	41000021F \$359.95	68328-06A \$94.95
Softail (except FXCW/C)	2007-2010	68207-07A \$339.95	68328-06A \$94.95
Softail FXCW/C	2008-2010	91684-08A \$339.95	68328-06A \$94.95
Softail	2003-2006	68207-00D \$299.95	68328-06A \$94.95
Softail	2000-2002	68207-00D \$299.95	— —
XG	2017-later	41000460 \$359.95	68328-06A*** \$94.95
XL	2014-later	41000087E \$359.95	68328-06A \$94.95
XL/XR	2007-2013	68200-07A \$339.95	68352-06B \$129.95
XL	2004-2006	68200-00D \$299.95	68352-06B \$129.95

*P/N 88115-03 Bank Angle Switch Kit (sold separately) or Security System P/N 68200-00D or 68200-07A are required for use on 2000-2013 FL Touring models equipped with a TLE/Ultra Sidecar.

**Pager function requires Remote Pager Receiver II P/N 91660-06 or 91672-07 (sold separately).

***17-later XG models require separate purchase of siren mounting bracket P/N 69201473.

830 GARAGE

Security & Keys

A. INTEGRATED SECURITY & LOCKING FLIP FOB

This hands-free fob automatically arms and disarms its electronic security functions as you approach and walk away from the bike. Keyed to match all your bike's locks, the combination fob with fold-away retractable barrel key lets you save room on your key ring and let one device do all the work.

90300118 **\$149.95**

Fits '17 Dyna® and Softail®, and '17-later Touring and Trike models equipped with H-D® Smart Security System. Does not fit Japan models. Key code required when ordering. Dealer installation required.

B. KEYED-TO-MATCH INDIVIDUAL REPLACEMENT LOCK PROGRAM

In the past, replacing a lock required the time and expense of re-keying a new lock or replacing all of the locks on your bike. Our Keyed-to-Match Program eliminates that hassle and allows you to order an exact replacement based on your lock's key code, right down to the quality you would expect from a stock Harley-Davidson® lock. Just ask your Dealer to refer to Bulletin Number 658B and they'll take care of your needs – lock, stock and barrel.

C. KEYED-TO-MATCH CUSTOM KEYS

Custom keys make a statement. Keys can be ordered through your Harley-Davidson Dealer and will be keyed to match your ignition and fork lock and are delivered in a leatherette gift box.

1. Commemorative CVO™ Ignition Key

Hand-polished brass key features a prismatic Bar & Shield logo set in a black field surrounded by Custom Vehicle Operations script. Available to CVO™ vehicle owners only.

71031-04 Barrel Style. **\$89.95**

Fits '91-later models with barrel style key.

2. Skull Ignition Keys

Key features the Harley-Davidson Skull logo in bright nickel with black accents.

71040-04 Barrel Style. **\$74.95**

Fits '91-later models with barrel style key.



A. INTEGRATED SECURITY & LOCKING FLIP FOB



A. INTEGRATED SECURITY & LOCKING FLIP FOB



B. KEYED-TO-MATCH INDIVIDUAL REPLACEMENT LOCK



C. KEYED-TO-MATCH CUSTOM KEYS

Notice: The prices appearing in this catalog are the manufacturer's suggested retail prices. Actual retail prices may vary.



D. HARLEY-DAVIDSON SECURITY SYSTEM PAGER RECEIVER II – BATTERY POWERED

HARLEY-DAVIDSON® SECURITY SYSTEM PAGER RECEIVER II

Designed to complement the Smart Siren II, this Pager Receiver can be linked to the vehicle with no additional installation. The Pager Receiver II monitors the Security System operation, and features multi-color LED indicators to display unique codes for arming, disarming and trigger modes. The Range Confirmation Signal (RCS) confirms and displays the signal reception. High-efficiency FM circuitry provides excellent reception, even in buildings and parking garages. Maximum effective range is up to 1/2 mile. The Pager Receiver II features selectable vibration or audible modes. The silent paging mode feature allows selectable programming trigger modes to avoid activating the siren.

D. PAGER RECEIVER II – BATTERY POWERED

The convenient built-in ultra-bright white LED flashlight helps light the way. The compact, lightweight receiver can be carried in your pocket, or the receiver holster can be clipped to a belt up to 1-3/4 inches wide. Kit includes receiver, holster, and one 3V lithium battery. Operates in conjunction with the Security System Fob and Smart Siren II.

91660-06 **\$74.95**
Fits all models equipped with the Harley-Davidson® Security System Smart Siren II. Certified for use in North America.

E. PAGER RECEIVER II – RECHARGEABLE

The compact, lightweight receiver can be carried in your pocket or clipped to a belt. Kit includes receiver and UL-listed battery charger (AC-DC with output of DC 4.5V 50mA for North America). Operates in conjunction with the Security System Fob and Smart Siren II.

91672-07 **\$89.95**
Fits all models equipped with the Harley-Davidson Security System Smart Siren II. Certified for use in North America.



E. HARLEY-DAVIDSON SECURITY SYSTEM PAGER RECEIVER II – RECHARGEABLE

F. BIKER'S COMPACT FIRST AID KIT

Keep this simple first aid kit with you wherever you go. The compact 9.0" x 4.0" x 2.0" zippered nylon case is small enough to fit inside all Harley-Davidson windshield bags, and contains: burn cream packets, hand sanitizer packets, antibiotic packets, eyewash, gauze pads, plastic and flexi strips, gauze, waterproof tape, latex-free gloves, cleansing towelettes, insect sting pads, scissors, tweezer/magnifier, survival wrap, and an English-language quick first aid guide. Intended for U.S. market.

93511-10 **\$29.95**



F. BIKER'S COMPACT FIRST AID KIT

Notice: The prices appearing in this catalog are the manufacturer's suggested retail prices. Actual retail prices may vary.

BODYGUARD IN A BOTTLE

Oil is the lifeblood of your engine. It not only lubricates the moving parts, it cools, cleans, and flushes away all the byproducts of combustion. It lives in an environment filled with heat, friction, and toxins that are determined to break it down and shorten its useful life. And it keeps the heart of your motorcycle beating at idle or at full throttle. Harley-Davidson's complete line of lubricants are formulated specifically to keep your motorcycle running strong, mile after mile.



ENGINE OIL FAQ'S

What's in a bottle of oil?

- The Base Stock makes up 75-80% of a bottle of oil. Generally, if it comes from the ground, it is a Mineral Oil. And if it is made in a lab or a reactor, it is Synthetic Oil.
- The Additive Pack makes up the remaining 20-25%. These are the ingredients that make oil smarter and tailored to its application. The additives include:
 - Viscosity Modifiers – lets oil flow like 20 weight oil at start-up and 50 weight oil at operating temperatures
 - Detergents – cleans inside your engine
 - Dispersants – suspends contaminants in the oil so they can be carried to the filter
 - Buffers – neutralizes acids that form in your engine
 - Anti-oxidants – prevents sludge and oil thickening oxidation
 - Corrosion inhibitors – protects internal components from corroding
 - Anti-wear additives – provides protection against internal wear

How often should I change my motorcycle engine oil?

You should change your motorcycle engine oil and engine oil filter at the first 1,000-mile service interval and at every 5,000-mile service interval thereafter. If you ride your motorcycle hard, under dusty conditions, or in cold weather, the engine oil and filter should be changed more often. You should always change your engine oil and filter prior to winter storage (or any extended storage) so that your engine oil is clean and free of contaminants during this time period.

What viscosity grade should I use in my Harley Motorcycle?

The recommended viscosity grade for all temperature conditions is SAE 20W50 Harley-Davidson® Motor Oil. The SAE 50 H-D® Motorcycle Oil is satisfactory in ambient temperatures of 60-80°F, and the SAE 60 H-D Motorcycle Oil in ambient temperatures above 80°F. SAE 20W50 covers the broadest range of operating temperatures.

What's the difference between synthetic and petroleum-based lubricants?

Group I, II and III petroleum-based lubricants are derived from oil pumped from the ground. Group IV and V synthetic lubricants are chemically produced in a lab. Petroleum-based lubricants inherit physical components (including contaminants) of the source crude oil in the refining process, while synthetic lubricants are custom-formulated to have desired properties for specific purposes, meaning that engineers have complete control of the lubricant from start to finish – at the molecular level.

What's better in my bike – Petroleum or Synthetic?

Petroleum lubricants have been around for a long time, and are effective at lubricating in most conditions, but mineral oil can't compete with the purity of synthetic lubricants—especially in extreme conditions. Synthetic oil does a better job reducing wear and resisting breakdown under a wider range of operating temperatures.

What does SYN3® full Synthetic Motorcycle Lubricant do for my drivetrain?

SYN3® Full Synthetic Motorcycle Lubricant offers all the benefits of Genuine Harley-Davidson 360 Motorcycle Oil, and:

- Offers superior wear protection at higher temperatures
- Keeps engines, transmissions and primary chaincases cleaner
- Meets the anti-wear lubricity requirements of all transmission gears
- Lubricates all primary chaincase components
- Delivers smooth, sure clutch operation
- Provides long-term protection of all internal components
- Improves seal and gasket performance
- Offers superior performance in high-output engines

What makes Harley SYN3 better than other Synthetics for my Harley?

- SYN3 is pure, genuine, full synthetic lubricant.
- SYN3 base stocks are synthesized materials - including Poly Alfa Olefin (PAO) and Esther, which are the most pure, highest quality synthetic base stocks available
 - SYN3 has the smartest, most robust additive package developed specifically to provide maximum performance and protection in H-D powertrains

Beware...not all synthetics are created equal.

- Due to a legal loophole, other brands are selling "Highly Refined Group III" mineral oil as synthetic oil
 - Head to head, SYN3 outperforms these oils
- SYN3 is a product you can trust, from a brand you can trust. Oil is the lifeblood to your Harley-Davidson; don't take chances with anything else.

Why should I use H-D® oil in my Harley?

- No one tests as much as we do – we test on the road, on dynos, and in the laboratory
 - We accumulate millions of testing miles on our engines and drive trains, using only H-D Oil
 - We test in the harshest environments – testing is performed in the extreme heat of the desert
 - We test under the most rigorous duty cycles – accelerated durability testing helps explore the limits of our designs, in less time. This is a worst case scenario for oil
 - We run thousands of hours on dynos
 - We test in the laboratory – sampling and analyzing oil to determine its life and effectiveness during use
- H-D's additive package is the best available, it's the most robust, it was created exclusively for H-D powertrains, and we are the only ones who have it.



A. SCREAMIN' EAGLE SYN3 FULL SYNTHETIC MOTORCYCLE LUBRICANT

A. SCREAMIN' EAGLE® SYN3® FULL SYNTHETIC MOTORCYCLE LUBRICANT

TESTED-CERTIFIED for use in Harley-Davidson® engine, primary chaincase and transmission applications, Screamin' Eagle® SYN3® Full Synthetic Lubricant makes changing and topping off fluids a simple, one-product process. Developed with a proprietary three synthetic basestock formula, Screamin' Eagle SYN3 Lubricant is formulated to provide for long-term protection and engine cleanliness requirements, and to provide superior high-temperature protection for high-output engines. SYN3 Lubricant is formulated to maintain the coefficient of friction for proper clutch operation and to provide the proper lubrication to the primary chain drive. In addition, SYN3 Lubricant is designed to provide the correct lubricity for the anti-wear requirements of transmission gears and for improved seal protection. This formula is approved by Harley-Davidson for use in all stages of engine life and is not detrimental to the break-in stage of engines.

Formulated for use in Harley-Davidson Engines, transmissions and the following primary chaincase applications: '71-later XL, '83-'84 XR1000, '08-'13 XR and '84-later FX, FXR, Dyna®, Softail®, Touring, and Trike models with wet-type diaphragm spring clutch.

United States

62600005	SAE 20W50 – 1 Quart.	\$12.95
62600031	SAE 20W50 – 1 Gallon.	\$48.95

Canada

62600011	SAE 20W50 – 1 Liter.	\$12.95
62600030	SAE 20W50 – 4 Liter.	\$48.95

Europe/Latin America

62600015	SAE 20W50 – 1 Liter.	\$12.95
-----------------	----------------------	----------------

Asia/Pacific

62600021	SAE 20W50 – 1 Quart.	\$12.95
62600059	SAE 20W50 – 1 Gallon.	\$48.95

B. GENUINE HARLEY-DAVIDSON® H-D® 360 MOTORCYCLE OIL

Genuine Harley-Davidson® H-D® 360 Motorcycle Oil is developed and tested for use in Harley-Davidson motorcycles. Our unique additive package helps prevent engine wear and helps keep your engine cooler, cleaner, and free of sludge, varnish and corrosion.

Harley-Davidson air-cooled V-Twin motorcycles operate at higher temperatures than water-cooled engines, thus a specific high temperature additive package is necessary to protect the engine. Be assured, H-D 360 Oil can be trusted in a Harley-Davidson engine.

Available in SAE 20W50, SAE 50, and SAE 60. Refer to your Harley-Davidson owner's manual for the proper SAE grade recommendation based on the climate and temperature range you ride in.

United States

62600007	SAE 20W50 – 1 Quart.	\$7.49
62600038	SAE 20W50 – 1 Gallon.	\$29.95
62600008	SAE 50 – 1 Quart.	\$7.49
62600009	SAE 60 – 1 Quart.	\$7.49

Canada

62600013	SAE 20W50 – 1 Liter.	\$7.49
62600041	SAE 20W50 – 4 Liter.	\$29.95
62600014	SAE 50 – 1 Liter.	\$7.49

Europe/Latin America

62600017	SAE 20W50 – 1 Liter.	\$7.49
62600042	SAE 20W50 – 4 Liter.	\$29.95
62600018	SAE 50 – 1 Liter.	\$7.49

Asia/Pacific

62600023	SAE 20W50 – 1 Quart.	\$7.49
62600043	SAE 20W50 – 1 Gallon.	\$29.95
62600024	SAE 50 – 1 Quart.	\$7.49
62600060	SAE 60 – 1 Quart.	\$7.49



B. GENUINE HARLEY-DAVIDSON H-D 360 MOTORCYCLE OIL

Notice: The prices appearing in this catalog are the manufacturer's suggested retail prices. Actual retail prices may vary.

834 GARAGE

Oil Filters

A. SUPERPREMIUM5™ OIL FILTERS – 5 MICRON

Utilizing advances in synthetic media technology, the SuperPremium5™ Oil Filters are Tested-Certified to provide filtration to retain dust, soot and other solid matter with low internal pressure drop. Filter also includes internal pressure relief and anti-drain back valves.

Fits '17-later Milwaukee-Eight®, '99-'17 Twin Cam and '99-later Evolution® models (except '08-'13 XR) and can be used as an upgrade for any motorcycle that requires Oil Filter P/N 63796-77A, 63805-80A, 63812-90 or 63813-90.

63798-99A Chrome. **\$14.95**

63731-99A Black. **\$12.95**

SuperPremium10 Oil Filter – 10 Micron (not shown)

Fits '02-'17 VRSC™ models.

63793-01K Black. **\$9.95**

B. GENUINE HARLEY-DAVIDSON® OIL FILTERS

Filter features cured resin impregnated paper which removes harmful foreign particles from the oil. End caps and thermal setting adhesive provide positive seals, preventing bypassing of contaminant-laden oil.

Fits all XB and Buell® models.

63806-00Y Black. **\$9.95**

Fits '15-later XG models.

62700045 **\$9.95**

Fits '91-98 Dyna® models.

63813-90 Chrome, Extra Long. **\$12.95**

Fits late '82-'84 FLH-80 Classics, '82-'86 FXWG, FXSB, FXEF and '79-early '84 XL models.

63810-80A Black, Short. **\$9.95**

Fits '84-later XL, '08-'13 XR, '82-'94 FXR, '84-'98 Softail® and '80-'98 FLHR, FLHT and FLT models.

63796-77A Chrome, Long. **\$10.95**

63805-80A Black, Long. **\$9.95**

CLASSIC MOTOR PARTS OIL FILTERS (not shown)

Quality filters at a great price. Replaces P/N 63840-53 or 63835-87T with a cartridge type filter and spring.

62700055 In Tank Oil Filter. **\$10.95**

Shell – Thicker shell material for extra strength. The heavier shell provides extra security against puncture from road debris.

Metal End-Cap – Provides positive seal for filter element assembly.

Center Tube – Prevents filter element collapse.

Filter Element – 100% wire-backed synthetic media provides superior filtration while keeping flow restriction low.

Bypass Valve – Oil Pressure Relief Valve is calibrated to protect engine. The Bypass Valve is designed to ensure oil flow in situations of excessive filter element flow restriction.

Steel Back Plate – Zinc-plated for superior rust prevention. Extra large inlet holes for lower flow resistance.

Gasket – Premium nitrile rubber with special lubricity compound to reduce torque during installation and removal.

Bar & Shield Stamp

Check Valve – Silicone anti-drain back valve prevents dry starts by eliminating oil drain back during shutdown. Silicone outperforms and outlasts standard nitrile rubber in both extreme cold and hot temperatures.

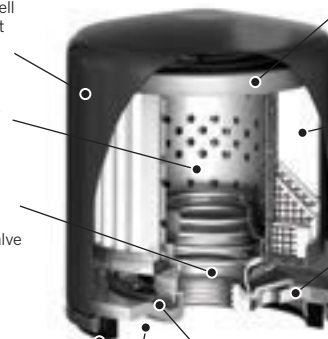

A. SUPERPREMIUM5 OIL FILTERS



A. SUPERPREMIUM5 OIL FILTERS



B. GENUINE HARLEY-DAVIDSON OIL FILTERS

Notice: The prices appearing in this catalog are the manufacturer's suggested retail prices. Actual retail prices may vary.

NEW



C. OIL CHANGE KITS – SYN3 – SAE 20W50 CHROME

NEW



C. OIL CHANGE KITS – SYN3 – SAE 20W50 BLACK

C. OIL CHANGE KITS

Everything you need for a complete engine oil and filter change. Select Harley-Davidson® approved Screamin' Eagle® SYN3® Synthetic Lubricant or genuine H-D360 motorcycle oil, and choose a black or chrome SuperPremium 5-micron oil filter. Package includes Oil, Oil Filter, and replacement O-Ring.

SYN3 – SAE 20W50

Fits '99-later Twin Cam and Sportster® Evolution® models (except '08-'13 XR) and can be used as an upgrade for any models that requires Oil Filter P/N 63796-77A, 63805-80A, 63812-90 or 63813-90.

62600082	4 Quarts + Chrome Oil Filter.	\$74.95
62600083	4 Quarts + Black Oil Filter.	\$71.95

Fits '17-later Milwaukee Eight® engine equipped models.

62600085	5 Quarts + Chrome Oil Filter.	\$87.95
62600084	5 Quarts + Black Oil Filter.	\$84.95

HD360 – SAE 20W50

Fits '99-later Twin Cam and Sportster Evolution models (except '08-'13 XR) and can be used as an upgrade for any models that requires Oil Filter P/N 63796-77A, 63805-80A, 63812-90 or 63813-90.

62600087	4 Quarts + Chrome Oil Filter.	\$52.95
62600088	4 Quarts + Black Oil Filter.	\$49.95

Fits '17-later Milwaukee Eight engine equipped models.

62600089	5 Quarts + Chrome Oil Filter.	\$60.95
62600090	5 Quarts + Black Oil Filter.	\$57.95

NEW



C. OIL CHANGE KITS – HD360 – SAE 20W50 CHROME

NEW



C. OIL CHANGE KITS – HD360 – SAE 20W50 BLACK

D. LOW PROFILE OIL DRAIN PAN

Reduce the mess and cleanup required when changing the fluids on your motorcycle. This reusable Drain Pan is designed specifically for use with Harley-Davidson® motorcycles. The low-profile design fits easily under standard height and lowered motorcycles, and slips beneath the bike even when on the side stand. The 10-quart capacity pan will capture 2 engine oil changes, or the complete drain fluids (engine oil, primary and transmission) from any H-D® Powertrain, including Milwaukee-Eight and Twin Cam motorcycle. The Drain Pan is large enough to catch the oil from the entire length of the primary, and is sized to hold and drain an inverted primary cover. The Drain Pan features a raised hardware corral, a filter drain surface, and a pressure vent hole to prevent messy oil burping. The drained waste oil is sealed safely inside the pan with high-quality gasketed caps and plugs. Convenient carrying handle simplifies transport to an approved waste oil facility.

63795-10	10-Quart Capacity.	\$30.95
-----------------	--------------------	----------------

D. LOW PROFILE OIL DRAIN PAN



Notice: The prices appearing in this catalog are the manufacturer's suggested retail prices. Actual retail prices may vary.

836 GARAGE

Oil Change Accessories

A. OIL CATCHER DRAIN OIL FUNNEL

Reduce oil drips when removing the oil filter. The Oil Catcher Funnel slips below the filter, and provides access to spin the filter off its mount. Oil is captured in the funnel, and is siphoned into a bottle or catch basin through the drain tube. Smooth orange plastic surface is easy to clean after use.

63794-10 **\$19.95**

Fits '04-later XL, '08-'13 XR, '99-'17 Dyna®, '99-'16 Touring and '09-'16 Trike models.

62700199 **\$22.95**

Fits '17-later Milwaukee-Eight® engine equipped models.



A. OIL CATCHER DRAIN OIL FUNNEL

B. PRIMARY OIL FILL FUNNEL

This reusable funnel makes it easy to add oil to your primary cavity. The funnel simply snaps into the derby cover opening to permit hands-free filling on the specified models. The convenient tab allows you to place the funnel in position with one hand, and the flat cone shape makes it easy to fill a tight area with no mess or spills. Smooth orange plastic surface is easy to clean after use.

62700239 **\$10.95**

Fits '18-later FL5B and '19-later Softail® models.

63797-10 **\$10.95**

Fits '06-'17 Dyna, '07-'18 Softail (except '18 FL5B), and '07-later Touring and Trike models.

62700015 **\$10.95**

Fits '84-'00 Evolution® 1340-equipped models, '99-'05 Dyna, '00-'06 Softail and '99-'06 Touring Twin Cam-equipped models.



B. PRIMARY OIL FILL FUNNEL



B. PRIMARY OIL FUNNEL
(63797-10 SHOWN)



B. PRIMARY OIL FUNNEL
(62700239 SHOWN)

C. TRANSMISSION/CRANKCASE FILL FUNNEL

Fill your transmission and crankcase without the mess. This funnel is shaped to fit into tight spaces, and is designed to reach even the toughest access points. The anti-burp design ensures smooth oil flow, and the smooth orange plastic surface is easy to clean after use.

63799-10 **\$4.95**



C. TRANSMISSION/CRANKCASE FILL FUNNEL



Notice: The prices appearing in this catalog are the manufacturer's suggested retail prices. Actual retail prices may vary.



D. ROAD FUNNEL



D. ROAD FUNNEL

This disposable folding funnel can be taken on the road and used for those times you need to replenish your bike's fluids. The funnel fits easily into your luggage, does not take up valuable storage space, and can be thrown away after use. Convenient tear-off 3-pack means you will always be prepared.

97410-10 **\$1.95**

E. OIL FILTER WRENCH – END CAP STYLE

Simplify oil filter removal and installation with this convenient End Cap Style Filter Wrench. The wrench grips the filter without crushing the canister, and allows the spin-on filter to be turned with a 3/8" drive socket wrench.

94863-10 **\$10.95**

For use with all H-D® spin-on oil filters (except '15- later XG).

14900091 **\$13.95**

For use with H-D spin-on oil filters for '15-later XG models.

F. OIL FILTER REMOVAL WRENCH

This slip-resistant wrench, featuring a stainless steel band, is designed to make the removal of your oil filter much easier.

94686-00 **\$10.95**

Fits all models with spin-on oil filters (except '15-later XG).



E. OIL FILTER WRENCH – END CAP STYLE



F. OIL FILTER REMOVAL WRENCH

Notice: The prices appearing in this catalog are the manufacturer's suggested retail prices. Actual retail prices may vary.

838 GARAGE

Oil & Lube

A. FORMULA+ TRANSMISSION AND PRIMARY CHAINCASE LUBRICANT

Developed with a proprietary mineral basestock formula and TESTED-CERTIFIED by Harley-Davidson Motor Company, Formula+ is blended to provide lubricity for the anti-wear requirements of transmission gears. Formulated to maintain the coefficient of friction for proper clutch operation and provide adequate lubrication to the primary chain, this lubricant is approved for use in all stages of transmission and primary chaincase life. Not for use in the crankcase as a motor oil.

TESTED-CERTIFIED Extended Service intervals:

Primary Chaincase

'84-later Big Twin models with wet-type diaphragm spring clutch. Every 10,000 miles, or prior to winter or extended storage periods.

Transmission

All Big Twin models. Every 20,000 miles, or prior to winter or extended storage periods.

Primary/Transmission

'71-later XL and '83-'84 XR1000 models. Every 10,000 miles, or prior to winter or extended storage periods.

Formulated for use in Harley-Davidson® Transmissions and the following Primary Chaincase applications: '71-later XL, '83-'84 XR1000, '08-'13 XR, and '84-later FX, FXR, Dyna®, Softail®, Touring and Trike models with wet type diaphragm spring clutch. Not for use in '02-later VRSC™ or '15-later XG models.

62600004	1 Quart – U.S.	\$8.49
62600010	1 Liter – Canada.	\$8.49
62600019	1 Liter – Europe.	\$8.49
62600033	1 Quart – Asia/Pacific.	\$8.49

Also available:

H-D® HIGH PERFORMANCE CHAIN LUBE PLUS

High Performance Chain Lube cleans as it protects. Can also be used on O-ring chains.

93600005	12 oz (340 g) Aerosol Can.	\$9.95
-----------------	----------------------------	---------------



A. FORMULA+ TRANSMISSION AND PRIMARY CHAINCASE LUBRICANT

B. H-D FORK OIL

Refer to Owner's Manual for required type.

62600025	Type B. 16 fl oz (473 ml) Bottle.	\$7.95
62600026	Type E. 16 fl oz (473 ml) Bottle.	\$7.95

C. H-D BIG PISTON FORK OIL

Blended specifically for '10-'13 XR1200X™ suspension.

99885-10	16 fl oz (473 ml) Bottle.	\$29.95
-----------------	---------------------------	----------------

D. SCREAMIN' EAGLE® PERFORMANCE FORK OIL

A heavier blended oil that provides extra damping in performance applications.

62600027	16 fl oz (473 ml) Bottle.	\$7.95
-----------------	---------------------------	---------------

Also available:

H-D FORK SEAL GREASE

Required for service of fork seals.

11300005	1 oz (28 g) Tube.	\$11.95
-----------------	-------------------	----------------

E. H-D GENUINE EXTENDED LIFE ANTIFREEZE AND COOLANT

Antifreeze is pre-diluted with deionized water to eliminate cooling system contamination. Formulated to use at full strength (do not add water), this coolant provides exceptional heat transfer properties. Protects the entire cooling system against corrosion. Formula is silicate-free, phosphate-free, nitrate-free and borate-free.

26800119	16 fl oz (473 ml) Bottle. For use in VRSC, XG, and Twin-Cooled™ models.	\$10.95
-----------------	--	----------------

99822-02	One gallon container. For use in VRSC, XG, and Twin-Cooled models.	\$22.95
-----------------	---	----------------



B. H-D FORK OIL



C. H-D BIG PISTON FORK OIL



D. SCREAMIN' EAGLE PERFORMANCE FORK OIL



E. H-D GENUINE EXTENDED LIFE ANTIFREEZE AND COOLANT

Notice: The prices appearing in this catalog are the manufacturer's suggested retail prices. Actual retail prices may vary.



F. H-D DOT 5 BRAKE FLUID



G. PLATINUM LABEL DOT 4 BRAKE FLUID

F. H-D® DOT 5 BRAKE FLUID

For use in all models (except '06-later VRSC™, '07-later XL, '08-later XR, '06-later Dyna® and Softail® and '05-later Touring and Trike models).

41800220 12 fl oz (355 ml) Bottle. **\$12.95**

G. PLATINUM LABEL DOT 4 BRAKE FLUID

For use in '06-'17 VRSC, '15-later XG, '07-later XL, '08-later XR, '06-'17 Dyna and '06-later Softail, and '05-later Touring and Trike models.

41800770 United States, Mexico, South America (except Brazil). **\$7.95**

41800771 Canada. **\$7.95**

41800772 Asia/Pacific. **\$7.95**

41800773 EU. **\$7.95**

41800774 Russia. **\$7.95**



H. H-D ETHANOL GUARD FUEL STABILIZER



I. SCREAMIN' EAGLE ASSEMBLY LUBE

H. H-D ETHANOL GUARD FUEL STABILIZER

Blended with corrosion inhibitors, this Fuel Stabilizer is formulated to protect fuel tanks, fuel lines, carburetors and injectors from long-term exposure to the adverse affects of ethanol-blended fuel. It fights deposits that can accumulate as a result of ethanol-produced solvents, and acts as a demulsifier to eliminate condensation in your fuel system. 4 ounces treats 10 gallons of fuel.

91600001 4 fl oz (118 ml) Bottle. **\$5.95**

I. SCREAMIN' EAGLE® ASSEMBLY LUBE

Screamin' Eagle® Assembly Lube provides superior protection during installation or servicing of internal engine components. Formulated with a high tackifier, this lubricant clings to parts and provides excellent start-up and break-in protection. It provides excellent corrosion resistance, and it won't drip off like common oil when you set coated parts aside to work on the rest of the engine. Recommended applications: cams, gears, crankpins, piston wrist pins, oil pumps, valve guides, rocker arm and push rod tips, and roller tappet wheels.

11300002 4 fl oz (118 ml) Tube. **\$10.95**



J. HARLEY AEROSOL LUBE



K. HARLEY LUBE

J. HARLEY® AEROSOL LUBE

Harley® Aerosol Lube is a Harley-Davidson® approved general lubrication oil.

93600113 10.5 oz (297 g) Aerosol Can. **\$9.95**

K. HARLEY LUBE

Harley Lube is a Harley-Davidson approved general lubricant.

94968-09 .25 fl oz (7.5 ml) Tube. **\$5.95**

L. H-D SPECIAL PURPOSE GREASE

Factory approved steering head bearing lubricant for '02-later VRSC, '15-later XG, '05-later XL and XR and '97-later Dyna, Softail (except Springer™), Touring and Trike models. Do not use on wheel bearings.

99857-97A 14 oz (409 g) Grease Gun Cartridge. **\$10.95**

M. H-D WHEEL BEARING GREASE

Recommended for wheel bearings and rear swingarm bearings.

99855-89 16 oz (454 g) Can. **\$9.95**

99856-92 14 oz (409 g) Grease Gun Cartridge. **\$8.95**

Also available:

H-D HIGH-PERFORMANCE SEALANT – GRAY

High-performance, room temperature vulcanized (RTV) silicone type liquid gasket is a low-odor, non-corrosive and non-conductive sensor-safe formula. Sealant allows high elongation when cured to absorb thermal and dynamic movement of the mating surfaces and is resistant to most chemicals and solvents. Temperature Range -76°F to 482°F (-60°C to 250°C).

99650-02 1.9 oz (54 g) Tube. **\$13.95**

Approved for use as crankcase sealant on all Harley-Davidson powertrains.



L. H-D SPECIAL PURPOSE GREASE



M. H-D WHEEL BEARING GREASE

Notice: The prices appearing in this catalog are the manufacturer's suggested retail prices. Actual retail prices may vary.

HARLEY-DAVIDSON® 12V BATTERY CHARGERS

HARLEY-DAVIDSON® BATTERY TENDERS AND CHARGERS

Extend the life of your motorcycle battery with an easy-to-use Battery Charger or Battery Tender. Designed to maintain full charge during storage or between rides, all Harley-Davidson® Battery Chargers include quick-disconnect harnesses for simple plug-in connection.

All H-D® Chargers have the following Battery Protection / Safety Features:

- State of Charge Indicator
- Spark Proof
- Short Circuit protection
- Reverse Polarity Protection
- Fully Automatic Charging
- Fused Ring Terminals
- Fused Alligator Clips



A. 750MA SUPERSMART® BATTERY TENDER

This compact Battery Tender is superior to a traditional auto parts store trickle charger. The built-in smart circuitry cycles the charger to turn itself on and off as needed, so your battery never overcharges.

B. 800MA WATERPROOF BATTERY TENDER

This waterproof, fully-automatic charger is ideal for both short term and seasonal storage, even if moisture sneaks into your storage area. The three-step charging system constantly monitors battery voltage to bring the battery up to full charge and switches to float mode to maintain the charge over extended periods of time. The vibration- and shock-resistant Battery Tender is reverse polarity protected and spark proof, even when the leads touch. The Tender features a front panel LED that indicates the battery's state of charge.

C. 1.25 AMP WEATHER-RESISTANT BATTERY CHARGER

Properly charge and maintain all H-D 12-volt batteries. The advanced solid-state circuitry constantly monitors the battery's charge, and manages the voltage without overcharging. The charger automatically switches to float mode and adjusts the charge rate up or down to keep the battery properly maintained for extended periods of time. The weather resistant construction provides peace of mind in case of exposure to moisture during charging.





D. 1.25 AMP BATTERY CHARGING STATION

Keep all your bikes fully charged and ready to ride. Harley-Davidson Battery Charger Stations are designed to fully charge and maintain lead-acid motorcycle batteries, maintaining them at proper voltage. The 4-step SuperSmart® charging process (Initialization, Bulk, Absorption, Float) helps to prevent sulfation and reduces the effects of overcharging. Status indicator lights allow you to monitor

E. 5 AMP WEATHER-RESISTANT BATTERY CHARGER

Professional charging performance in a compact package. With a typical recharge time of 1 to 2 hours, this charger features advanced solid-state circuitry that constantly monitors the battery's charge and maintains the voltage without overcharging. The charger automatically switches to float mode and adjusts the charge rate up or down to keep the battery properly maintained for extended periods of time. The weather resistant construction provides peace of mind in case of exposure to moisture during charging.

	A. 750 mA	B. 800 mA
APPLICATION	Meets basic battery tending needs.	Maintain battery even if bike is parked outdoors
TYPICAL RECHARGE TIME (HOURS)	8 – 12	8 – 12
MANUFACTURERS LIMITED WARRANTY	5 years	3 years
WEATHER PROOFING	–	Waterproof
FEATURES	Fully Automatic Charging State of Charge Indicator Spark Proof Short Circuit Protection Reverse Polarity Protection	Fully Automatic Charging State of Charge Indicator Spark Proof Short Circuit Protection Reverse Polarity Protection
FUSED BATTERY HARNESS INCLUDED	Quick Connect Harness & Alligator Clip Harness	Quick Connect Harness & Alligator Clip Harness

U.S. CANADA MEXICO SOUTH AMERICA (EXCEPT ARGENTINA)	 PLUG TYPE "A"	66000038 120V	66000004 120V, 60HZ
EUROPE	 PLUG TYPE "C"	–	99814-09 220-240V, 50/60HZ
UNITED KINGDOM	 PLUG TYPE "G"	–	99816-09 220-240V, 50/60HZ
AUSTRALIA	 PLUG TYPE "I"	–	99819-09 220-240V, 50/60HZ
JAPAN	 PLUG TYPE "A"	–	99820-09 100V, 50/60HZ
MSRP		\$39.95	\$49.95

Notice: The prices appearing in this catalog are the manufacturer's suggested retail prices. Actual retail prices may vary.



C. 1.25 Amp

D. 1.25 Amp Multi-bank

E. 5 Amp

Faster charging than 750mA or 800mA	Charges 2 or 4 batteries at once	FASTEST charging time, a drained battery will never delay your ride again!
4 – 8	4 – 8	1 – 2
5 years	2 years	5 years
Weather Resistant	–	Weather Resistant
Fully Automatic Charging State of Charge Indicator Spark Proof Short Circuit Protection Reverse Polarity Protection	Fully Automatic Charging State of Charge Indicator Spark Proof Short Circuit Protection Reverse Polarity Protection	Fully Automatic Charging State of Charge Indicator Spark Proof Short Circuit Protection Reverse Polarity Protection
Quick Connect Harness & Aligator Clip Harness	Quick Connect Harness & Aligator Clip Harness	Quick Connect Harness & Aligator Clip Harness

66000033 120V, 60Hz	2 bank 99829-09 4 bank 99847-09 100-240 Vac, 50/60Hz	66000041 120V, 60Hz
–	–	66000042 100-240V, 50/60Hz
–	–	66000043 100-240V, 50/60Hz
–	–	66000044 100-240V, 50/60Hz
66000034 100V, 50/60Hz	–	66000046 100V, 50/60Hz
\$79.95	2-bank \$129.95 4-bank \$249.95	\$129.95

842 GARAGE

Charging Accessories

A. HOG® BOOSTER PORTABLE BATTERY PACK

Think of it as a kick start for your weak battery. This lightweight, compact lithium powered battery pack is ready and waiting to jolt your battery back to life. Small enough to fit in your saddlebag or backpack, this 1000 Amp portable battery pack will restart your motorcycle in seconds. The HOG® Booster easily connects to your motorcycle battery with high-quality alligator clamps, and the spark proof and reverse polarity protected connections help protect your bike's electrical system.

The HOG Booster's internal lithium battery can be recharged anywhere – from a wall outlet using your cell phone charging block, from your computer's USB port, or from a 12V power outlet (with the included adapter). A fully charged HOG Blaster will start up to 20 dead batteries. HOG Booster can also power and charge USB devices like cell phones and cameras to keep you in touch while on the road. The HOG Blaster also features a built-in 100 lumen flashlight with high, low and strobing SOS modes so you have a light source when you need it.

Complete kit includes HOG Booster unit, high quality alligator clips and cables, 12V/cigarette Lighter adaptor, handy storage bag, and easy to read instruction manual.



A. HOG BOOSTER PORTABLE BATTERY PACK

Technical Data:

Internal Battery = Lithium Ion

Peak current Rating = 1000A

Joules = 7000J

Micro USB (Input) = 5V, 2.1A

USB (output) = 5V, 2.1A

Weight = 2.4 lbs.

Flashlight Lumens = 100

USB Charger Rating = .5A–12 hrs; 1A–6 hrs; 2A–3 hrs.

66000130 For US and Canada markets. **\$129.95**

66000147 For Europe, Middle East, Africa, Asia Pacific markets. **\$129.95**

B. BATTERY CHARGING HARNESS WITH LED CHARGE INDICATOR

This Battery Charging Harness features an integrated LED indicator light that illuminates when your battery voltage drops to a level that requires charging. Just attach the ring terminals to your battery and route the harness for easy access to the plug connector. When the LED glows, it's time to connect the bike to a Harley-Davidson® Battery Tender. Compatible with all Harley-Davidson Battery Chargers, the harness features in-line 7.5 Amp fuse protection, and the plug connector is protected with a weather-shield cap when not in use.

66000005 **\$14.95**

For use with Harley-Davidson 12-volt batteries.



B. BATTERY CHARGING HARNESS WITH LED CHARGE INDICATOR

C. BATTERY CHARGING HARNESS

Heavy-duty Battery Charging Harness with ring terminals and in-line 7.5 Amp fuse protection for attachment to a Harley-Davidson 12-volt battery. The wiring harness utilizes a plug connector that is compatible with all Harley-Davidson Battery Chargers equipped with black connectors. The ring terminals are attached to the battery with the harness routed to allow access for the plug connector attachment to a H-D® Battery Charger. The harness plug connector is protected with an attached weather-shield cap when not in use.

94624-97B **\$8.95**

For use with Harley-Davidson 12-volt batteries.



C. BATTERY CHARGING HARNESS

D. BATTERY CHARGING EXTENSION LEAD

Low-loss leads feature the same quick-disconnect 2-prong plugs as found on the charger unit and the available charging harnesses.

For use with most Harley-Davidson Battery Chargers.

99821-09 12.5' **\$14.95**

99828-09 25' **\$19.95**

Also available:

H-D® ELECTRICAL CONTACT LUBRICANT

Ideal for use on multi-pin connectors, bulb bases, and battery terminals, this specially formulated Electrical Contact Lubricant offers excellent film strength that is resistant to water (including salt water). Safe for use on tin, nickel, copper, brass, gold and silver contacts, and the formula is compatible with electrical connector plastics and elastomers.

11300004 1 oz (28 g) Tube. **\$12.95**



D. BATTERY CHARGING EXTENSION LEAD

Notice: The prices appearing in this catalog are the manufacturer's suggested retail prices. Actual retail prices may vary.

H-D® AGM* ORIGINAL EQUIPMENT BATTERIES**

Genuine H-D® Batteries offer the latest technology for higher cold cranking amps, long life and improved rechargeability. Featuring the latest AGM technology and great Harley-Davidson® graphics, these batteries are durable, long-lasting and trouble-free. Made in the U.S.A.

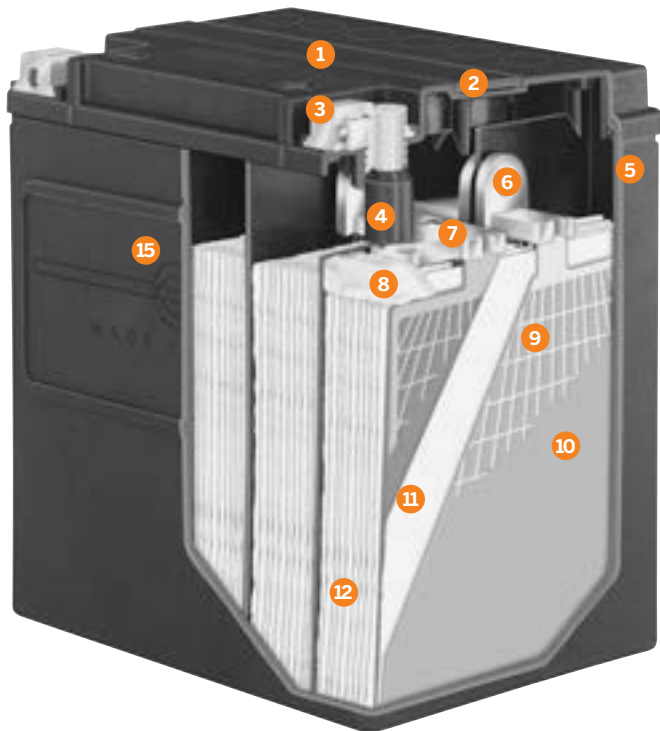

Motorcycle batteries built and rigorously tested to Harley-Davidson's exacting requirements. H-D® AGM battery ratings are determined by the strict regulations and testing of the Battery Council International.



****WARNING:** Battery posts, terminals and related accessories contain lead compounds, chemicals known to the State of California to cause cancer and birth defects.

- 1 Completely sealed, valve regulated maintenance-free design eliminates acid spills and corrosion damage.
- 2 Re-engineered vent system is specially designed to minimize leakage.
- 3 Exclusive molded terminal design increases strength and durability.
- 4 Unique positive post bushing resists vibration damage and retards acid leaks and corrosion.
- 5 Heat sealed cover prevents electrolyte leakage and improves reliability.
- 6 Larger diameter through-partition welds direct more power to the starting motor.
- 7 Heavy top lead improves plate-to-lug adhesion for vibration resistance and long life.
- 8 Plates are lock-bonded together, reducing vibration damage for longer life.

- 9 Exclusive calcium/calcium alloy grids provide highest cranking amps and lowest self-discharge. Full frame, power path design directs more power to the terminals for quick, sure starts.
- 10 High density oxide provides maximum power-per-pound or dependable "high cycling" service.
- 11 Tear-resistant AGM* separators protect plates, ensuring long life.
- 12 Exclusive demineralized electrolyte improves service life. Metered addition of electrolyte means no excess acid.
- 13 Positive terminal protector (not shown) protects against short circuits and sparks.
- 14 Stainless steel terminal bolts (not shown) won't rust or corrode.
- 15 Distinguished Harley-Davidson Bar & Shield is molded into case, for quick, confident recognition.

*Absorbed Glass Mat

ORIGINAL EQUIPMENT & REPLACEMENT BATTERIES

H-D AGM BATTERIES

65989-97D Dual (Top and Side) Terminal Design. **\$134.95**
Fits '07-'17 VRSC™ (except '07 VRSCR), '97-'03 XL, and '97-'17 Dyna® and '97-later Softail® models. Also fits Buell® S1, S3/T, M2, and X1 models.

66010-97D Dual (Top and Side) Terminal Design. **\$174.95**
Fits '97-later Touring and '09-later Trike models.

65958-04B **\$114.95**
Fits '15-later XG, '04-later XL and '08-'12 XR models. Also fits Buell 1125R/CR models.

65948-00B **\$115.95**
Fits '02-'06 VRSC and '07 VRSCR models. Also fits Buell XB and Blast models.

65991-82B **\$130.95**
Fits '77-'78 XLCR, '79-'96 XL, '73-'94 electric start FX and FXR, '99-'00 FXR and '84-'90 Softail models. Replaces P/Ns 65991-82A and 65991-75C. Also fits Buell S2/T Thunderbolt™ models.

66010-82B **\$145.95**
Fits '80-'96 FLHR, FLHT and FLT Touring models.

65989-90B Fits '91-'96 Dyna and Softail models. **\$130.95**

NOTE: Battery dimensions of Harley-Davidson® AGM Batteries P/N 65989-97C, 65989-90B and 65991-82B may not allow use of accessory side covers on XL and Dyna models.

CONVENTIONAL BATTERIES** (not shown)

66006-29F 6V. **\$74.95**
Fits '64-earlier FL and '63-earlier GE models.

HEAVY-DUTY HIGH-CRANKING PREMIUM BATTERY**

66007-84 12V. **\$140.95**
Fits '65-'84 FL, FLH, '67-'78 XLH (except '77-'78 XLCR), and '64-later GE models.

Notice: The prices appearing in this catalog are the manufacturer's suggested retail prices. Actual retail prices may vary.

844 GARAGE

Tools

A. ALL-IN-ONE FOLDING TOOL

This kit is the ideal traveling companion. This compact folding tool is equipped to perform the basic on-the-road service functions on most late-model Harley-Davidson® motorcycles. Large comfortable handle with a soft grip adds leverage, and holds the foldaway tools. Tool selection: Torx® bits – T27, T40; Hex Bits – 3/32", 1/4", 3/8"; Screwdriver Bits – Phillips, slotted; Open end wrenches (2) – 9/16", 1/2", 10mm. Kit includes nylon pouch with hook-and-loop closure and Bar & Shield logo.

94435-10 **\$44.95**

Fits '02-later models (except VRSC™).



A. ALL-IN-ONE FOLDING TOOL

B. 8-IN-1 SCREWDRIVER

Ideal tool for most of the screws on H-D® products. The unique 8-in-1 design conveniently stores all fittings within handle. Included are #40, 30, 27, and 25 Torx, #2 and 3 Phillips and 2 slotted driver bits. Quality engineered by Snap-On® with lifetime guarantee against breakage.

94669-00 **\$20.95**



B. 8-IN-1 SCREWDRIVER

C. COMBINATION AXLE WRENCH

Individual combination front and rear axle wrenches available for your model.

1. 94695-08 .75" & 36mm. **\$17.95**

Fits '02-'07 Touring models.

2. 94697-08 .9375" & 36mm. **\$16.95**

Fits '08-'17 Dyna®, '08-later Softail® and Touring models.



C. COMBINATION AXLE WRENCH

D. SHOCK ADJUSTMENT SPANNER

The Universal Spanner is small enough to carry in a H-D Tool Kit, and is designed to adjust the spring load on all mechanically adjustable H-D rear shock absorbers.

94448-82B **\$12.95**

For use on models with mechanically adjustable H-D rear shock absorbers. Does not fit XG500, XG750, XR, '16-later XL, XL models equipped with Premium Emulsion Shocks P/N 54000076, 54000077 or Dyna models with Premium Emulsion Shocks P/N 54000066.



D. SHOCK ADJUSTMENT SPANNER

E. BELT TENSION TESTER TOOL

Use to check tension on secondary belt.

40006-85 **\$34.95**



E. BELT TENSION TESTER TOOL

F. STAINLESS STEEL TRAYS WITH MAGNETIC BASE

Convenient storage tray with a magnetic base secures small metallic parts during maintenance. Use it horizontally, vertically or upside down. The magnetic base is covered with a protective coating to prevent damage to surface finishes.

94793-01 6" Diameter. **\$11.95**



F. STAINLESS STEEL TRAYS WITH MAGNETIC BASE

Notice: The prices appearing in this catalog are the manufacturer's suggested retail prices. Actual retail prices may vary.

G. HARLEY-DAVIDSON® PREMIUM TOOL KIT

This Premium Harley-Davidson® branded Tool Kit features all the tools you need for common maintenance on your motorcycle. The heavy-duty tools are conveniently secured in a hinged carrying case, and lock in place for simple organization. Tools feature large, easy-to-read size indicators, and are stamped with the classic Harley-Davidson script. Lifetime warranty.

64-Piece Kit includes:

- 1 – Quick-Release Ratchet (3/8" Drive)
- 1 – 3" Extension (3/8" Drive)
- 1 – 6" Extension (3/8" Drive)
- 1 – Universal Joint (3/8" Drive)
- 11 – SAE Deep Sockets 3/8" – 1" (3/8" Drive)
- 8 – Metric Deep Sockets 10mm – 17mm (3/8" Drive)
- 1 – Spark Plug Socket 5/8" (3/8" Drive)
- 6 – Hex Sockets 1/8" – 3/8" (3/8" Drive)
- 6 – Torx® Sockets T25-T50 (3/8" Drive)
- 2 – Spinner Handle (1/4" Drive) with Adaptor
- 6 – Bits (Slotted, Phillips, Torx)
- 9 – SAE Combination Wrenches 1/4" – 3/4"
- 8 – Metric Combination Wrenches 8mm – 17mm
- 1 – Diagonal Pliers – 7"
- 1 – Slip Joint Pliers – 8"
- 1 – Needle Nose Pliers – 8"

14900033

\$274.95

H. HARLEY-DAVIDSON/SNAP-ON® TOOL KITS

These tool kits were developed specifically for Harley-Davidson by Snap-on® to perform the most functions with the least amount of tools and weight. Provides all the right tools, without compromising quality or damaging your motorcycle's hardware. Lifetime warranty.

H-D®/Snap-on Compact Tool Kit

Designed to provide the most tools in the least amount of space, this tool kit rolls into a compact pouch for easy transport.

94684-00A

\$219.95

For use with '00-later models (except VRSC™, XG and FXR4).

H-D/Snap-on Softail® Tool Kit

Tailored to the Softail® motorcycle, this high-quality tool kit is compact to take anywhere, and shaped to fit Softail models equipped with teardrop-shaped tool box.

94668-00

\$184.95

For use with '00-'17 Softail models.

I. HARLEY-DAVIDSON TOOL KIT

This is the ideal carry-along tool kit for your Harley-Davidson motorcycle. The kit was developed to perform most service functions and weigh as little as possible to keep your load light.

94819-02

\$84.95

For use with '86-later XL, '08-'13 XR, '99-'17 Dyna®, and '99-later Softail, Touring, and Trike models.

J. TOOL KIT FOR VRSC™ MODELS

Designed specifically for the V-Rod® motorcycle, this is the ideal carry-along tool kit for your VRSC™ model. The kit includes the metric tools required to perform most service functions with the least amount of carrying weight.

94820-02

\$89.95

For use with '02-'17 VRSC models.



G. HARLEY-DAVIDSON PREMIUM TOOL KIT



H. H-D/SNAP-ON COMPACT TOOL KIT ('00-LATER MODELS SHOWN)



H. H-D/SNAP-ON SOFTAIL TOOL KIT ('00-LATER SOFTAIL MODELS SHOWN)



I. HARLEY-DAVIDSON TOOL KIT



J. TOOL KIT FOR VRSC MODELS

Notice: The prices appearing in this catalog are the manufacturer's suggested retail prices. Actual retail prices may vary.

846 GARAGE

Air Filters

A. HARLEY-DAVIDSON® ORIGINAL EQUIPMENT AIR FILTER ELEMENTS

Late-model pleated paper type elements with aluminum back plates.

29400078	\$25.95
Fits '15-later XG models (except XG750A).	
29331-04	\$31.95
Fits '04-'13 XL models with oval air cleaner assembly.	
29400015	\$26.95
Fits '14-later XL models with round air cleaner cover.	
29377-08	\$26.95
Fits '08-'12 XR models.	
29437-01A	\$44.95
Fits '02-'17 VRSC™ models.	
29400042	\$26.95
Fits '99-'06 carbureted Twin Cam equipped models, '01-'15 EFI Softail® (except '08-'11 FLSTSB, '11-later FXS, '12-later FLS and '13-later FXDB) and '02-'07 EFI Touring and Dyna® models.	
29633-08	\$26.95
Fits '08-'13 Touring and Trike models.	
29400267	\$42.40
Fits '18-later FLFBS, FLHCS, FXBRS and FXFBS and '17-later CVO™ Touring models with Milwaukee-Eight® engine and ventilator air cleaner.	
29400248	\$19.95
Fits '18-later Softail models (except FLFBS, FLHCS, FXBRS and FXFBS).	
29400045	\$26.95
Fits '16-'17 Softail (except FLSTFBS) and '14-'16 Touring and Trike models.	
29400212	\$19.95
Fits '17-later Touring and Trike models with Milwaukee-Eight engine and wedge-shaped air cleaner.	
29191-08	\$26.95
Fits '08-'15 Dyna models with teardrop air cleaner.	
29314-08	\$26.95
Fits '13-later FXDB, '12-'15 FLS, '08-'11 FLSTSB and '11-'13 FXS models.	
29509-06	\$26.95
Fits '06-'10 FLHTCUSE models.	
29462-99	\$26.95
Fits '99-'01 EFI Twin Cam models (except '01 Softail).	
29291-95	\$26.95
Fits '95-'99 Evolution® 1340 models with electronic fuel injection (EFI).	
29259-91A	\$26.95
Fits '91-'95 Evolution 1340-equipped Dyna, FXR, Softail, and Touring models.	
29331-96	\$26.95
Fits '88-'03 Evolution XL models.	
29259-86	\$19.95
Fits '86-'89 Evolution 1340 models.	
29325-95A	\$26.95
Fits '95-'03 Evolution XL and 1340 models. (International models only. See your Dealer.)	



A. HARLEY-DAVIDSON ORIGINAL EQUIPMENT AIR FILTER ELEMENTS



A. XR1200 AIR FILTER ELEMENT



A. VRSC AIR FILTER ELEMENT



A. FOAM STYLE AIR FILTER ELEMENTS

Notice: The prices appearing in this catalog are the manufacturer's suggested retail prices. Actual retail prices may vary.



B. SCREAMIN' EAGLE HIGH-FLO K&N AIR FILTER ELEMENT



B. SCREAMIN' EAGLE HIGH-FLO K&N AIR FILTER ELEMENT – HEAVY BREATHER



B. SCREAMIN' EAGLE HIGH-FLO K&N AIR FILTER ELEMENT – HEAVY BREATHER

B. SCREAMIN' EAGLE® HIGH-FLO K&N® AIR FILTER ELEMENT

K&N® replacement air filters are engineered to improve airflow for increased horsepower and quicker acceleration. K&N filters provide excellent filtration, and because they are washable and reusable, you can clean the filter whenever conditions demand. Designed as direct replacements for specified fitments.

NOTE: These washable and rechargeable filters use a special coating to help filter fine particles from the incoming air. With time, the oil in the filter will dissipate and the element will begin to turn gray. Clean the surface and renew the original red color with an application of K&N Air Filter Care products.

1. 29400020 High-Flow–Multi-fit. **\$59.95**
Fits '07-later XL, '99-'07 Dyna®, '00-'15 Softail®, and '99-'07 Touring models equipped with High-Flow Air Cleaner Kits. Replacement for P/N 29442-99E.

1. 29400358 High-Flow – Multi-fit. **\$59.95**
Fits '18-later Softail and '17-later Touring and Trike models equipped with round High-Flow Air Cleaner P/N 29400355 or 29400356.

2. 29400021 High-Flow–Dyna. **\$59.95**
Fits '08-'17 Dyna models equipped with High-Flow Air Cleaner Kit. Replacement for P/N 29385-08.

3. 29400019 High-Flow–Touring. **\$59.95**
Fits '16-'17 Softail and '08-'16 Touring and Trike models equipped with High-Flow Air Cleaner Kit. Replacement for P/N 29244-08.

4. 29400247 High-Flow – Wedge. **\$69.95**
Fits '17-later Touring and Trike models equipped with Wedge High-Flow Air Cleaner Kit P/N 29400245 or 29400246.

5. 29400065 Extreme Billet. **\$59.95**
Fits '15-later XG, '16-'17 Softail, and '08-later Touring and Trike models equipped with Extreme Billet Agitator and Chisel Air Cleaner Kits.

5. 29400118 Extreme Billet & Rail. **\$59.95**
Fits '07-later XL, '08-'17 Dyna and '08-'15 Softail and models equipped with Extreme Billet Chisel and Agitator or Rail Collection Air Cleaner Kits.

5. 29400359 Extreme. **\$69.95**
Fits '18-later Softail and '17-later Touring and Trike models equipped with round High-Flow Air Cleaner P/N 29400357.

6. 29400109 Burst Collection. **\$59.95**
Fits '08-'17 Dyna and Softail models, '08-'16 Touring and Trike models equipped with Burst Collection Air Cleaner Kits.

7. 29400022A Ventilator–Multi-fit. **\$59.95**
Fits models equipped with Twin-Cam Ventilator and Extreme Billet Ventilator Performance Air Cleaner Kits. Replacement for P/N 29670-09.

8. 29400293 Ventilator. **\$59.95**
Fits '18-later Softail, '17-later Touring and Trike models equipped with Ventilator Air Cleaner P/N 29400298 or 29400299.

9. 29424-05B Heavy Breather–Multi-fit, Chrome. **\$89.95**
Fits models equipped with Heavy Breather Kit P/N 29098-09, 29299-08, 29080-09 or 29264-08.

9. 29702-08B Heavy Breather–Touring, Chrome. **\$89.95**
Fits models equipped with Heavy Breather Kit P/N 29006-09B, 29253-08B, 29000065 or 29400105.

9. 29400297 Heavy Breather–Touring, Black. **\$119.95**
Fits '16-'17 FXDLS and models equipped with Heavy Breather Kit P/N 29006-09B, 29253-08B, 29000065 or 29400105.

10. 28714-10 Heavy Breather–Compact, Chrome. **\$89.95**
Fits '08-'16 Touring and Trike models equipped with Compact Heavy Breather Kit P/N 28716-10A.

11. 29400141 Heavy Breather Elite, Chrome. **\$109.95**
Fits models equipped with Screamin' Eagle® Heavy Breather Elite Performance Air Cleaner Kit P/N 29400172 and 29400173.

11. 27300139 Heavy Breather Elite, Black. **\$119.95**
Fits Replacement air filter for models equipped with Screamin' Eagle Heavy Breather Elite Performance Air Cleaner Kit P/N 29400285.

12. 29400276 Heavy Breather, Black. **\$109.95**
Fits '18-later Softail, '17-later Touring and Trike models equipped with Heavy Breather Air Cleaner P/N 29400263 or 29400264.

13. 29400275 Heavy Breather, Chrome. **\$109.95**
Fits '18-later Softail, '17-later Touring and Trike models equipped with Heavy Breather Air Cleaner P/N 29400263 or 29400264.

Notice: The prices appearing in this catalog are the manufacturer's suggested retail prices. Actual retail prices may vary.

848 GARAGE

Spark Plugs

A. SCREAMIN' EAGLE® PERFORMANCE SPARK PLUGS

Screamin' Eagle® Spark Plugs feature double platinum coating for superior erosion resistance and extended life. The "V" trimmed ground electrode reduces shrouding of the flame front to promote flame propagation, and the fine wire center electrode enhances startups and ignitability. Screamin' Eagle Plugs feature Ribbed Core Technology (RCT) that provides resistance to fouling, and are designed with Original Equipment-style noise suppression to prevent electrical interference with radios and CB communication equipment. Works great in racing applications where rich air/fuel conditions are required. Unique style with Screamin' Eagle logo. Sold in pairs.

Standard Compression Applications

Designed for modified engines including performance carburetors, high-flow air cleaners, camshafts, exhaust systems and ignition systems in conjunction with stock compression ratios.

31600106 Standard Compression Applications. **\$19.95**
Fits '99-'17 Twin Cam-equipped models, and '86-later Evolution® Sportster® 883, 1100 and 1200 models.

31600085 Standard Compression Applications. **\$19.95**
Fits '15-later XG models and '17-later Milwaukee-Eight® engine equipped models.

High Compression Applications

These plugs are designed for high performance applications involving modifications in high-flow air cleaners, camshafts, exhaust, performance heads, ignition components, higher compression ratios above Original Equipment configurations or engines specific for racing applications.

31600105 High Compression Applications. **\$19.95**
Fits '99-'17 Twin Cam-equipped models. '86-later XL and XR and Evolution® 1340 models equipped with Screamin' Eagle Performance Cylinder Heads.

B. HARLEY-DAVIDSON® GOLD SPARK PLUGS

A special thread and shell coating ensures quick and easy removal from aluminum heads and resists corrosion. A gold palladium insert extends life and improves resistance to corrosion. The tapered tip provides better spark exposure to air/fuel mixture and allows the mixture to flow more easily through gap area for maximum combustibility. Fouling resistance is improved with smaller diameter center electrode wire and insulator tip. Plus, a copper-cored ground electrode runs cooler for extended life.

32365-04 (6R12G) **\$6.95 each**
Fits '86-later XL and '99-'17 Twin Cam-equipped models or use in place of No. 6R12.

32367-04 (5R6AG) **\$6.95 each**
Fits later '78-'84 Shovelhead and '84-'99 Evolution 1340-equipped models or use in place of Nos. 5R6A and 5RL.

27794-08 (10R12X) **\$5.95 each**
Fits '08-'12 XR models.

C. HARLEY-DAVIDSON ORIGINAL EQUIPMENT SPARK PLUGS

32335-04 (10R12A) **\$4.95 each**
Fits '02-'17 VRSC™ models.

31600012 (6R10) **\$4.95 each**
Fits '15-later XG models and '17-later Milwaukee-Eight engine equipped models.

32342-04 (5R6A) **\$3.95 each**
Fits later '78-'84 Shovelhead and '84-'99 Evolution 1340-equipped models.

32362-04A (6R12) **\$4.95 each**
Fits '86-later Evolution-equipped XL models and '99-'17 Twin Cam-equipped models.

32338-04 (4R5) Fits '71-'85 Sportster. **\$4.95 each**

32336-04 (4R) **\$3.95 each**
Fits '54-'56 KH, '57-'70 XL-900, '71-'85 Iron Sportster and '48-'74 FX and FLH models.

32337-04 (3-4) Fits '48-'74 FLH/FX. **\$4.95 each**

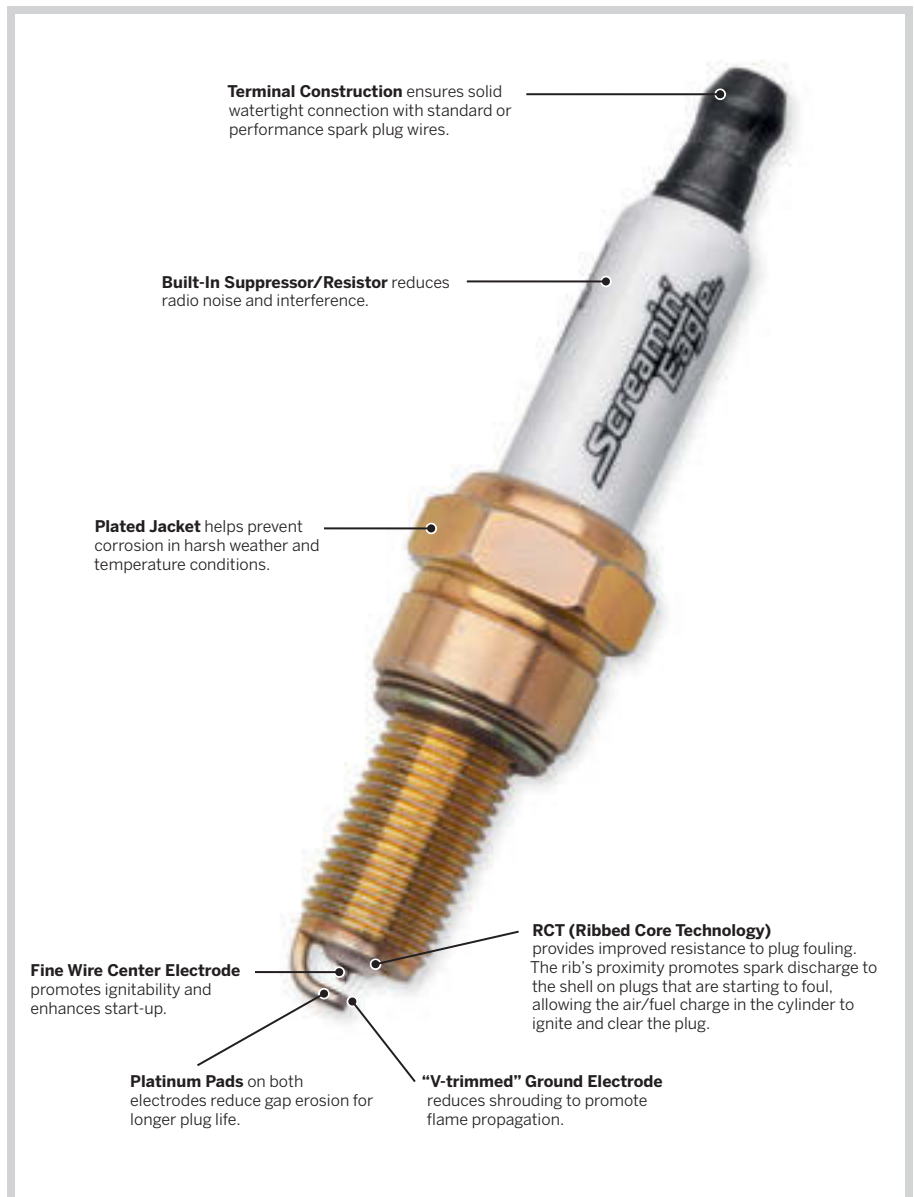

A. SCREAMIN' EAGLE PERFORMANCE SPARK PLUG



B. HARLEY-DAVIDSON GOLD SPARK PLUGS



C. HARLEY-DAVIDSON ORIGINAL EQUIPMENT SPARK PLUGS

Notice: The prices appearing in this catalog are the manufacturer's suggested retail prices. Actual retail prices may vary.

D. H-D® ORIGINAL EQUIPMENT BRAKE PADS

Front

41300169 Front. **\$44.95**
Fits '16-later XG models (Left Side on XG750A).

41300196 Front. **\$49.14**
Fits '17-later XG750A models (Right Side).

42897-08 Front. **\$49.95**
Fits '08-'17 VRSC™ models.

42897-06A Front. **\$49.95**
Fits '06-'07 VRSC models.

41300004 Front. **\$59.95**
Fits '14-later XL models.

42831-04A Front. **\$48.95**
Fits '04-'13 XL models.

42739-08 Front. **\$51.95**
Fits '08-'13 XR models.

46363-11 Front. **\$56.95**
Fits '12-'17 Dyna® and '11-'14 Softail® (except Springer™) models.

41300102 Front. **\$59.95**
Fits '15-later Softail models.

44082-08 Front. **\$45.95**
Fits '08-'11 Dyna and '08-'10 Softail (except Springer) models.

41854-08 Front. **\$51.95**
Fits '08-later Touring and '08-'13 and '19-later Trike models.

44063-83D Front. **\$53.95**
Fits '84-'99 XL, '84-'86 FX, '84-'99 FXR, '91-'99 Dyna, '00-later Springer, '84-'99 Softail and '84-'99 FLHR, FLHT and FLT models.

41300027 Front. **\$53.95**
Fits '14-later Trike models.

Front & Rear

41300072 Front/Rear. **\$39.95**
Fits '15 XG models

44082-00E Front/Rear. **\$53.95**
Fits front and rear brakes on '00-'05 VRSC, '00-'03 XL and '00-'07 Dyna, Softail and Touring models (except front brakes on FXSTS and FLSTS Springer). Does not fit '06-'07 rear brakes on FLSTFSE, FXST, FXSTB and FXSTS models.

Rear

41300161 Rear. **\$44.95**
Fits '16-later XG models.

42850-06B Rear. **\$46.95**
Fits '06-'17 VRSC models.

41300053 Rear. **\$53.95**
Fits '14-later XL models.

42029-07 Rear. **\$42.95**
Fits '07-'13 XL models.

42836-04A Rear. **\$42.95**
Fits '04-'06 XL models.

42310-08 Rear. **\$42.95**
Fits '08-'13 XR models.

41300197 Rear. **\$54.95**
Fits '18-later Softail models.

42298-08 Rear. **\$53.95**
Fits '08-'17 Dyna and Softail models.

44209-87D Rear. **\$65.95**
Fits later '87-'99 XL, FXR, Softail and '91-'99 Dyna models.

41852-08B Rear. **\$57.95**
Fits '08-later Touring models. Does not fit Trike models.

43957-86F Rear. **\$59.95**
Fits '86-'99 FLHR, FLHS, FLHT and FLT models.

41300033 Rear. **\$92.95**
Fits '14-later Trike models.

83911-09B Rear. **\$92.95**
Fits '09-'13 Trike models.

41300214 Rear. **\$111.95**
Fits '19-later Trike models.



D. H-D ORIGINAL EQUIPMENT BRAKE PADS

Notice: The prices appearing in this catalog are the manufacturer's suggested retail prices. Actual retail prices may vary.

850 GARAGE

Tire Inflators

A. TIRE PRESSURE GAUGE AND FILL VALVE

Simplify checking the air pressure level and filling the tires on your motorcycle. This Tire Pressure Gauge features an 18" flexible hose and 2-way air chuck with both a 45° fill port and a unique side fill port that provides easy straight-in access to hard-to-reach motorcycle valve stems. The dual-range instant-read gauge measures pressures from 0-60 psi and 0-400 kPa, and is protected from impact and abrasion by a thick rubber collar. Designed to fit an air compressor with a standard 1/4" quick-disconnect coupler, this gauge allows you to check the pressure and fill the tire without removing the chuck from the tire. Just apply the chuck to the valve stem, read the pressure, and add air by depressing the comfortable trigger lever. And for checking tire pressure on the road, you can use this tool like any standard tire gauge.

12700096A

\$79.95

B. COMPACT AIR COMPRESSOR WITH LIGHT

Correct tire pressure is crucial to safe operation and long tire life, but checking the pressure, finding a gas station with a working air pump, and filling the tire is a chore that many of us ignore. The Compact Air Compressor is designed to simplify this necessary procedure. The compact, lightweight 12V pump is designed for life on the road. The all-in-one pump plugs into your bike's battery charging harness, and features a built-in 0-160 psi pressure gauge and bright LED work light. The 11" air hose and 6' fuse-protected power cord easily reach the front and rear wheels, and are stored in convenient compartments when not in use. The lightweight pump features durable, impact-resistant construction, and is small enough to fit easily in a saddlebag or strap-on luggage. Kit includes pump, valve stem extension, and nylon carrying bag.

12700020

\$42.95



A. TIRE PRESSURE GAUGE AND FILL VALVE



A. TIRE PRESSURE GAUGE AND FILL VALVE



B. COMPACT AIR COMPRESSOR WITH LIGHT

Notice: The prices appearing in this catalog are the manufacturer's suggested retail prices. Actual retail prices may vary.



C. VALVE STEM EXTENSION

C. VALVE STEM EXTENSION

Sometimes there's just not enough space around the tire's valve stem for the gas station air chuck and hose to reach. Brake rotors, sprockets and saddlebags get in the way and keep the air chuck from making an airtight seal. When that happens, this Valve Stem Extension provides easy access. Simply screw the extension in place on the stem, fill the tire to the proper pressure, remove the extension, and replace the valve stem cap. Then toss the extension in your saddlebag or tool roll for the next time.

42300009 **\$10.95**

D. COMPACT TIRE GAUGE AND TREAD DEPTH INDICATOR

Combination dial air pressure and tread depth gauge provides easy access to the valve stem. A durable internal diaphragm provides accurate air pressure readings with a dual range indicator for 0-60 psi and 0-400 kPa readings. The pressure relief valve is activated by a push button to eliminate inner gauge air pressure after use. The integrated tire tread depth gauge features a dual-range color-coded indicator, calibrated in 1/32" (0-14/32") and millimeters (0-11mm), for monitoring tread wear. A protective rubber boot covers the housing to protect the gauge from impact and abrasion.

75008-02A Compact. **\$34.95**

75137-98B **\$41.95**

Compact with braided stainless steel lead.



D. COMPACT TIRE GAUGE AND TREAD DEPTH INDICATOR



D. COMPACT TIRE GAUGE AND TREAD DEPTH INDICATOR WITH STAINLESS STEEL LEAD

E. DIGITAL TIRE PRESSURE GAUGE

Back-lit Digital Tire Pressure Gauge is easy to read at any time of day. Providing accurate pressure readings in 0.50 psi increments up to 60 psi. Scale can be changed to read psi, bar, Kg or kPa pressure with the touch of a button. This versatile gauge features a 12" braided line and 90 degree angle chuck for easy access to valve stems, and a tough rubber jacket to protect the gauge from damage. Batteries are included.

75158-10 **\$41.95**

F. TIRE GAUGE AND TREAD DEPTH INDICATOR WITH EMBOSSED LEATHER POUCH

Chrome-plated steel gauge housing with Harley-Davidson script and 90 degree air chuck. Dual range indicator for air pressure and tire tread depth readings. Calibrated for 10-50 psi and 0-32/32" tread depth readings. Rotate the indicator shaft 90 degrees in the housing for 70-345 kPa and 0-30mm tread depth readings. Complete with a Bar & Shield logo embossed leather pouch.

75110-98B **\$19.95**



E. DIGITAL TIRE PRESSURE GAUGE



F. TIRE GAUGE AND TREAD DEPTH INDICATOR WITH EMBOSSED LEATHER POUCH

Notice: The prices appearing in this catalog are the manufacturer's suggested retail prices. Actual retail prices may vary.

DUNLOP® • HARLEY-DAVIDSON®

Since 1984, Dunlop® Tires has provided Original Equipment and service replacement tires for Harley-Davidson® Motorcycles. Dunlop is recognized as the world-leader in motorcycle tire design, engineering and manufacturing excellence.

DUNLOP • HARLEY-DAVIDSON TIRE SERIES

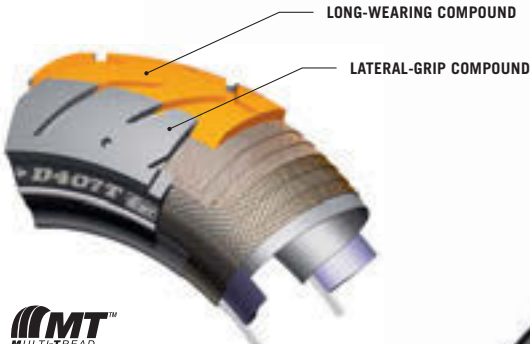

Dunlop D407 and D429T tires feature MT Multi-Tread™ technology that pairs a long-wearing center compound with a high-grip side compound for improved ride, handling and tread life.

Refer to H-D.com/shop for tire fitments or see your Dealer.

DUNLOP • HARLEY-DAVIDSON
D402 TOURING TIRE



DUNLOP® • HARLEY-DAVIDSON® TIRES

D407/D407T/D408 TOURING

The D407/D408 tire is constructed for '09-later FL Touring, select Softail® and specific Custom Vehicle Operations™ (CVO™) models and is available exclusively through Harley-Davidson® Dealers. The FL Touring rear tires feature Dunlop's advanced MT Multi-Tread™ technology.

- Tire features bold Harley-Davidson script on the sidewall.
- MT Multi-Tread rear tire incorporates a tough tread compound in the center that runs cooler to provide stability, excellent traction under braking and long life and to each side is a section of lateral-grip compound that enhances traction at higher lean angles for great grip while cornering.
- Reinforced multi-layer tire carcass gives the tire strength for long life and provides stability at highway speeds and maximum lean angles.
- Bold, angled lateral grooves in the tread pattern evacuate water from the contact patch on wet roads.
- The D407/D408 is available in blackwall, slim white and wide-white sidewall styles.
- The D407T is only available in blackwall style.



Blackwall

Slim Whitewall



D402 TOURING

Built with a three-ply polyester casing with two fiberglass belts, the D402 offers greater load-carrying capacity and stability.

- Computer-optimized tread profile with offset center groove improves rider confidence over rain grooves and steel-grated bridges, while reducing cupping for even wear.
- The D402 is available in blackwall, slim whitewall, wide whitewall and engraved wide whitewall styles.

Blackwall

Slim Whitewall

Wide Whitewall

Engraved Wide Whitewall



Blackwall

Wide Whitewall

Blackwall

Blackwall

D401/D401T CRUISER

An advanced tread pattern and specifically formulated compound deliver outstanding grip in wet or dry weather and provide long tire life.

- D401 tires use bias or bias-belted construction and incorporate a computer-optimized tread profile to reduce cupping for even wear.

GT502 PERFORMANCE

GT502 Performance Tires feature an optimized profile, contact patch and compound for superior grip in dry conditions, with solid grip during wet weather riding conditions.

SIGNATURE SERIES

Signature Series Tires are packed with features for responsive handling and confident cornering to tighten the connection between you and the road.

MICHELIN® TIRES

Since 1889, Michelin® has been a leader in the tire industry. From introducing the world's first radial tire in 1946, to being the first to use radial motorcycle tires in race competition, Michelin has demonstrated its dedication to producing some of the world's most innovative tire products. A leader in racing technology, Michelin researches, tests and develops tire solutions in the most demanding form of racing competition. Harley-Davidson® motorcycle riders benefit from that technology, as Michelin transfers track technology into Harley-Davidson motorcycle riding confidence and performance.



MICHELIN
SCORCHER® 31
BLACKWALL

Refer to H-D.com/shop for tire fitments or see your Dealer.



MICHELIN® • HARLEY-DAVIDSON® TIRES

MICHELIN® SCORCHER® TIRES

Made exclusively for Harley-Davidson

The Scorchers are the first Michelin® – Harley-Davidson® co-branded tire, with a bold Harley-Davidson script on the sidewall. Featuring an exceptional combination of durability, comfort and handling. The Scorchers 11 and Scorchers 31 are factory-installed on many models, and can be installed as a replacement tire on other specified models.

- **Rear Tire Architecture:**
Provides stability, great handling, plus comfort.
- **3 Polyester Carcass Plies:**
Strong and supple casing for comfort on long rides.
- **2 Aramid Belt Plies:**
Maintains consistent contact patch for a long and even wear life.



MICHELIN *Scorchers* 31

Remarkable Grip:

Innovative rubber compounds, incorporating know-how derived from Michelin's decades of road-racing experience, provide remarkable grip on both wet and dry roads.

Exceptional Comfort and Handling:

The supple casing design and profile of MICHELIN® Scorchers® 31 tires promote rock-solid handling on winding roads.

Long Mileage:

Michelin carbon black-enriched rubber compounds promote excellent durability without compromising performance.

MICHELIN *Scorchers* 11

Outstanding Grip:

Semi-slick tread pattern maximizes the contact patch for excellent adhesion on dry roads. Optimized tread groove design efficiently evacuates water for dependable wet grip.

Excellent Tread Life:

Derived from Michelin's championship-winning racing tires, newly developed rubber compounds combine durability and high performance.

Precise Handling:

The latest generation of Michelin radial technology allows for easy maneuverability and impressive agility.



856 INDEX

Product	V-ROD®	SPORTSTER®	DYNA®	SOFTAIL®	TOURING
Selecting a Windshield	–	60	106	166, 216	305
Selecting a Seat	–	65	112	172, 223	324-325
Selecting a Backrest	–	73	119	184-185, 234	–
Selecting Touring Accessories	–	–	–	184-185, 235	355
Selecting Performance Upgrades	–	435	435	435	435
Selecting a Collection	–	524-525	524-525	524-525	524-525
Selecting Dominion™ Accessories	578-579	578-579	526-527, 578-579	526-527, 578-579	526-527, 578-579
#1 Skull Engine Trim Collection	–	541	541	541	541
21" Front Fender	–	–	–	–	791
21" Knockout™ Front Wheel	–	–	–	–	756
Adaptive LED Headlamps	–	–	714	714	714
Advanced Audio Radio/Accessories	–	–	–	–	656-682
Air Cleaner Covers	–	558-564	558-564	562-564	562-565
Air Cleaner Kits	–	498-499	468-475	468-475	468-475
Air Deflectors	–	–	111	222	311, 321
Air Filter – K&N®	–	508, 847	508, 847	508, 847	508, 847
Air Filter Elements	846	508, 846-847	508, 846-847	508, 846-847	508, 846-847
Air Foil Luggage Racks	–	78	123	238	–
Air Pump with Light	850	850	850	850	850
Air Wing Fender Rail for Trike	–	–	–	–	344
Air Wing Horn Cover	–	751	751	751	751
Air Wing Luggage Racks	–	–	–	239	344, 352, 363
Air Wing Saddlebag Lid Rails	–	–	–	–	365
Airflow Engine Trim Collection	–	539	539	539	539
Airflow Grip/Peg Collection - Chrome	598, 606	598, 606	598, 606	598, 606	598, 606
Airflow Grip/Peg Collection - Gloss Black	599, 606	599, 606	599, 606	599, 606	599, 606
Ancra Tie-Downs	824	824	824	824	824
Antennas	–	–	–	–	688-689
Antifreeze and Coolant	838	–	–	–	838
Ape Handlebars	–	639	640-641	640-641	639-641, 647
Auxiliary Brake and Tail Lamp	–	738, 744	738, 744	738, 744	420-423, 739-745
Auxiliary Lamp Bulbs	–	717, 721	717, 721	717, 721	717, 721
Auxiliary Lighting/Fog Lamps	–	720	717-722	717-722	717-723

Product	V-ROD®	SPORTSTER®	DYNA®	SOFTAIL®	TOURING
Auxiliary Power Ports	–	694	694	694	694
Auxiliary Switches	–	–	–	–	428
Auxiliary Switch Housings	629	629	629	629	629
Axle Adjuster Hardware	–	–	–	275	–
Axle Covers – Front	–	94-95	136	206-207, 264-265	392-393
Axle Covers – Front Installation Kit	–	–	–	207	–
Axle Covers – Rear	34	98	140-141	212-213, 274-275	–
Axle Wrench	–	–	844	844	844
Backpack – Sissy Bar	774	774	774	774	774
Backrest – Passenger	32-33	75-76	116, 121-122	186-187, 235-236	344, 346-350
Backrest – Rider	–	67	114	177, 229	329, 338-339
Backrest Pads – Sissy Bar	32-33	75-76	116, 121-122	187-188, 235-236	346-350
Backrest Pads – Tour-Pak®	–	85	–	–	357-359
Badlander® Seats	–	69	115	173, 229	336
Banjo Bolt Kits	627	627	139, 627	270, 627	391, 627
Bar End Mirrors	20, 57, 618	20, 57, 618	20, 57, 618	20, 57, 618	20, 57, 618
Bare Metal Polish	813	813	813	813	813
Batteries	843	843	843	843	843
Battery Chargers	840-842	840-842	840-842	840-842	840-842
Battery Charging Harness	842	842	842	842	842
Battery Charging Extension	842	842	842	842	842
Battery Covers/Boxes	–	102	143-145	–	–
Beach Handlebar	–	–	635	635	635
Bearing Greases	839	839	839	839	839
Belt Guards	–	97	140	271	417
Black Standard Line Saddlebags	–	84	–	194, 248	–
Black Standard Line Bags	776	776	776	776	776
Black Fin Engine Trim Collection	–	–	546	546	546
Bluetooth® Headsets	683-686	683-686	683-686	683-686	683-686
Bobber Solo Seats	–	70	117	182-183	–
Bobtail Fender Racks	–	–	–	238	–
Boom!™ Audio – Stage I	–	–	–	–	658-663
Boom! Audio Amplifier Kits	–	–	–	–	659, 666, 676
Boom! Audio Antennas	–	–	–	–	688-689

858 INDEX

Product	V-ROD®	SPORTSTER®	DYNA®	SOFTAIL®	TOURING
Boom!™ Audio Bass Booster Port Kit	–	–	–	–	680
Boom! Audio Communications	–	685-686	685-686	685-686	672, 684-687
Boom! Audio Cruiser Speaker Kits	–	691	691	691	691
Boom! Audio Fairing Lower Speaker Kits	–	–	–	–	662, 663, 668, 669, 680
Boom! Audio Headsets	–	685-686	685-686	685-686	672, 684-687
Boom! Audio iPod® Interface	–	–	–	–	681
Boom! Audio Music and Intercom Kit	–	–	–	–	682, 684-686
Boom! Audio Saddlebag Speaker Kit	–	–	–	–	661, 668, 679
Boom! Audio SiriusXM® Satellite Radio	–	–	–	–	672, 681
Boom! Audio Speaker Kits	–	–	691	691	659-680, 691
Boom! Audio Speaker Trim	–	–	–	–	405-408
Boom! Audio Speakers – Saddlebag Mount	–	–	–	–	661, 668, 679
Boom! Audio Speakers – Trike Body	–	–	–	–	662, 669
Boom! Bagger Kits	–	–	–	–	660, 677
Boom! Audio – Stage II	–	–	–	–	664-670
Boot Mark Remover	811	811	811	811	811
Brake Caliper Covers/Inserts	34	99	139	270	390-391
Brake Calipers	34	99	139	207, 269	390
Brake Disc Hardware	–	767	767	767	767
Brake Fluid	839	839	839	839	839
Brake Levers	38	–	131	200	376
Brake Pads	849	849	849	849	849
Brake Pedal Pads/Covers	–	–	580-605	580-605	580-605
Brake Rotors	34, 765-766	765-766	765-766	765-766	757, 759, 765-766
Brass Collection	–	538, 594-595	538, 594-595	538, 594-595	538, 594-595
Brawler® Seats	–	68	115	173, 229	336
Buckshot Accessories	–	97	–	–	–
Bug Eater Sponge	815	815	815	815	815
Bug Remover	810	810	810	810	810
Bumpers	–	–	–	279	399, 418
Bungee Cords/Nets/Straps	778	778	778	778	778
Bungee Soft Hooks	778	778	778	778	778
Burst Collection	601	601	552, 601	552, 601	393, 390, 408, 552, 601
Burst Grip/Peg Collection	601	601	601	601	601

Product	V-ROD®	SPORTSTER®	DYNA®	SOFTAIL®	TOURING
Café Custom	-	54	-	-	-
Café Custom Tail Section	-	55	-	-	-
Café Fairing	-	64	111	-	-
Café Seat	-	68	-	-	-
Cam Tensioner	-	-	486	486	486
Cams	-	503	484	460, 484	460, 484
Cartridge Forks	-	88	128	252	386
Cell Phone Carriers	690	690	690	690	690
Center Stand	-	-	-	-	384
Chain and Lock Kits	825-827	825-827	825-827	825-827	825-827
Chain Lube	838	838	838	838	838
Chizeled Handlebar	-	636	636-637	636	636-637
Chopped Engine Guard	-	-	-	-	384
ChoppedTour-Pak™	-	-	-	-	798-800
Chrome and Rubber Grip/Peg Collection	602, 607	602, 607	602, 607	602, 607	602, 607
Circulator Seat and Backrest Pads	-	72	118	181, 232	343
Cleaning Brushes	814-815	814-815	814-815	814-815	814-815
Cleaning/Detailing Products	808-816	808-816	808-816	808-816	808-816
Clip-On Handlebar	-	56	-	-	-
Clocks	705	705	705	705	705
Clubman Handlebar	-	56	-	-	-
Clutch – Slipper/Variable Pressure	516	-	515	515	515
Clutch Kits	516	516	514-516	514-516	514-516
Coil Covers	-	-	144	276	-
Collection – #1 Skull	-	541	541	541	541
Collection – Airflow – Chrome	539, 598, 606	539, 598, 606	539, 598, 606	539, 598, 606	539, 598, 606
Collection – Airflow – Gloss Black	599, 606	599, 606	599, 606	599, 606	599, 606
Collection – Black Fin	-	-	546	546	546
Collection – Brass	-	538, 594-595	538, 594-595	538, 594-595	538, 594-595
Collection – Burst	601	601	552, 601	552, 601	393, 390, 552, 601
Collection – Dark Custom	-	540	540	540	540
Collection – Defiance	586-588	586-588	533-535, 586-588	533-535, 586-588	533-535, 586-588
Collection – Dominion™	578-583	578-583	578-583	526-531, 578-583	526-530, 578-583
Collection – H-D® Motor Co.	-	545	545	545	545

860 INDEX

Product	V-ROD®	SPORTSTER®	DYNA®	SOFTAIL®	TOURING
Collection – Kahuna™	584-585	584-585	536-537, 584-585	536-537, 584-585	536-537, 584-585
Collection – Live to Ride	–	544	544	544	544
Collection – Rail	–	558	–	–	–
Collection – Willie G Skull – Chrome	–	542	542	542	542
Collection – Willie G Skull – Black	–	543	543	543	543
Color Shop Limited Series	–	–	–	786-787	784-787
Compact Windshields	30	62-63	108-109	168-169, 218	306
Console Kits	–	102	–	209, 250	411-413
Controls Collections – Airflow Chrome	539, 598, 606	539, 598, 606	539, 598, 606	539, 598, 606	539, 598, 606
Controls Collections – Airflow Gloss Black	599, 606	599, 606	599, 606	599, 606	599, 606
Controls Collections – Brass	594-595	594-595	594-595	594-595	594-595
Controls Collections – Burst	601	601	601	601	601
Controls Collections – Chrome & Rubber	602, 607	602, 607	602, 607	602, 607	602, 607
Controls Collections – Crested	605, 607	605, 607	605, 607	605, 607	605, 607
Controls Collections – Defiance Black	588-589	588-589	588-589	588-589	588-589
Controls Collections – Defiance Chrome	590-591	590-591	590-591	590-591	590-591
Controls Collections – Defiance Machine Cut	586-587	586-587	586-587	586-587	586-587
Controls Collections – Diamond Black	600	600	600	600	600
Controls Collections – Dominion™ Black	580	580	580	580	580
Controls Collections – Dominion Bronze	581	581	581	581	581
Controls Collections – Edge Cut	592-593	592-593	592-593	592-593	592-593
Controls Collections – Kahuna	584-585, 607	584-585, 607	584-585, 607	584-585, 607	584-585, 607
Controls Collections – Nostalgic	603, 607	603, 607	603, 607	603, 607	603, 607
Controls Collections – Streamliner	604, 607	604, 607	604, 607	604, 607	604, 607
Controls Collections – Willie G Skull	596-597, 607	596-597, 607	596-597, 607	596-597, 607	596-597, 607
Coolent Line	39	–	–	–	–
CoolFlow™ Fan Kit	–	–	–	–	322
Crate Engines	–	–	–	–	512-513
Crested Grip/Peg Collection	605, 607	605, 607	605, 607	605, 607	605, 607
Cruise Control Kits	–	–	–	629	629
Cruiser Amp and Speaker Kits	–	691	691	691	691
Cruiser Cradle Wheel Chock	823	823	823	823	823
Cup Holders	–	–	–	778	778
Cut Back Side Covers	–	59, 101	–	–	–

Product	V-ROD®	SPORTSTER®	DYNA®	SOFTAIL®	TOURING
Cylinder Base Cover	–	–	555	555	548, 555
Dark Custom™ Engine Trim Collection	–	540	540	540	540
Dash Panel Extension	–	–	145	250	–
Daymaker™ LED Headlamps	715	715, 717	714-717	714-717	714-717
Decals	804	804	804	804	804
Defiance Grip/Peg Collection	586-591	586-591	586-591	586-591	586-591
Denim Paint Cleaner	811	811	811	811	811
Derby Covers	–	528-546	528-546, 550-553	528-546, 550-553	528-546, 550-553
Detach Depot Storage Racks	–	822	822	822	822
Detachable Latch Kits	–	77, 827	121, 827	191, 240, 827	345, 827
Detachable Latches – Locking	–	77, 827	121, 827	191, 240, 827	345, 827
Detachable Saddlebags	–	82	125	192-194, 241-243	–
Detachable Seat Hardware	–	72	118	183, 233	341
Detachable Sideplates/Backrest	–	74-75	120-121	186, 235-236	344, 346-347
Detachables Lock	–	77, 827	121, 827	827	345, 827
Detailing/Cleaning Products	808-816	808-816	808-816	808-816	808-816
Diamond Black Grip/Peg Collection	600	600	600	600	600
Dipsticks	39	101, 565	565	565	565
Disc Brake Locks	825	825	825	825	825
Docking Hardware – HoldFast™	–	–	–	185	–
Docking Hardware – Sissy Bar/Rack	–	73	119	185	345
Docking Hardware Covers	–	571	571	571	571
Document Holder	779	–	–	–	–
Dominion™ Collection – Black	580	580	580	528, 531, 580	528, 580
Dominion Collection – Bronze	581	581	581	529, 531, 581	529, 581
Dominion Collection Inserts	582-583	582-583	582-583	530-531, 582-583	530-531, 582-583
Down-Tube Bags	–	85	85	–	–
Duffel Bags	774-775	774-775	774-775	774-775	774-775
Dunlop Tires	852-853	852-853	852-853	852-853	852-853
Edge Cut Collection	592-593	592-593	592-593	548, 592-593	548, 592-593
Edge Cut Grip/Peg Collection	592-593	592-593	592-593	592-593	592-593
EFI Tuners	–	436-439	436-439	436-439	436-439
Electra Glide® Windshields	–	–	–	–	308-310
Electrical Accessory Adapters	694-695	694-695	694-695	694-695	525-528, 694-695

862 INDEX

Product	V-ROD®	SPORTSTER®	DYNA®	SOFTAIL®	TOURING
Engine Brightener	812	812	812	812	812
Engine Covers/Black Kits	-	558-559	550-553	532-535, 550-553	532-535, 550-553
Engine Covers/Chrome Kits	39	560	551-556	535, 551-556	535, 551-556
Engine Guard Footpeg Mounts	612-615	612-615	612-615	612-615	612-615
Engine Guards	38	93	134	203, 259	384-385
Engine Mounts	-	561	-	-	549, 557
Engine Transmission Interface Covers	-	-	-	555	555
Engines – LongBlock	-	-	520-521	520-521	520-521
Engines – Milwaukee-Eight®	-	-	-	-	512
Engines – Twin Cam	-	-	-	-	513
Enrichener/Choke Knob Cover	-	566	566	566	566
Ethanol Guard	839	839	839	839	839
Exhaust Mounting Brackets	-	-	-	-	482
Exhaust Shields	-	503	477	451, 455, 479	456, 479
Extended Side Covers	-	-	-	-	793
Extreme Billet Air Cleaners	-	499	473	473	473
Extreme Ventilator Air Cleaners	-	-	472	472	472
Fairing Air Deflectors	-	-	-	-	311
Fairing Bras	-	-	-	-	429
Fairing Edge Lights	-	-	-	-	712
Fairing Lower Accessories	-	-	-	-	320
Fairing Lowers	-	-	-	-	320
Fairing Mount Mirrors	-	-	-	-	410, 616-617
Fairing Pouches	-	-	-	-	318-319
Fairing Trim – Illuminated	-	-	-	-	712
Fan Kit – CoolFlow™	-	-	-	-	322
Fender Bibs	-	72	118	233	-
Fender Bra – Trike	-	-	-	-	373
Fender Skirts	-	-	-	277	401
Fender Strut Covers/Hardware	-	-	142	-	417
Fender Tips/Trim/Spears	-	-	145	277-279	399-401
Fenders – Front	-	-	-	398	398
Finned Headbolt Bridges	-	567	567	567	567
First Aid Kits	831	831	831	831	831

Product	V-ROD®	SPORTSTER®	DYNA®	SOFTAIL®	TOURING
Flag Kits – American	780	780	780	780	780
Flag Kits – POW/MIA	781	781	781	781	781
Flag Kits – Wounded Warrior Project®	781	781	781	781	781
Fog Lamps	–	–	718	718	718-719
Foot Controls – Extended Reach	–	90	129-130	199, 253-254	373-377
Foot Controls – Rear Set	–	58	–	–	–
Foot Controls – Reduced Reach®	–	90	129-130	–	–
Footboard Covers	–	–	–	611	382-383
Footboard Mounts – Passenger	–	–	132	258	380-381
Footboard Mounts – Rider	–	–	131	199	375
Footpeg Mounts/Hardware	613, 615	92, 613, 615	132-133, 613, 615	202, 257, 613, 615	380, 613, 615
Footpegs and Shifter Pegs	580-605	580-605	580-605	580-605	580-605
Fork Bags	–	–	777	777	–
Fork Braces	35	96	138	263	–
Fork Dust Covers	–	–	137	–	–
Fork Nut Covers	–	96	137	210, 268	–
Fork Oil	838	838	838	838	838
Fork Slider Covers/Tins	–	–	–	205, 262	389-390
Fork Sliders	–	94	135	204, 261	388-389
Forward Control Kits	–	89-90	129-130	199, 253	–
Frame Inserts/Trim	–	–	–	272	–
Front End Kits	–	–	135	261	389
Front Fender – Wrapped	–	–	–	–	790
Fuel Caps – Flush Mount	–	103, 701	701	701	701
Fuel Caps and Medallions	–	103, 701-703	701-703	211, 701-703	701-703
Fuel Gauges	–	100	701, 704	701, 704	701, 704
Fuel Stabilizer	839	839	839	839	839
Fuel Tank Console Doors	–	–	–	–	412-413
Funnels	836-837	836-837	836-837	836-837	836-837
Further Forward Mid-Control Kits	–	90	129-130	–	–
Garage Door Opener	821	821	821	821	821
Gauge Bezels/Trim Rings	–	700	700	209, 700	402-409, 700
Gauges	–	100, 696	696-697, 699	696-697, 699	696-699
Gauges – Fairing Mount	–	–	–	–	698-699

864 INDEX

Product	V-ROD®	SPORTSTER®	DYNA®	SOFTAIL®	TOURING
Gear Indicator	697	697	697	697	697
Get-A-Grip™ Hand Grips	608	608	608	608	608
Glaze™ Poly Sealant	812	812	812	812	812
Gloss Detailer	812	812	812	812	812
GPS – zūmo®	692-693	692-693	692-693	692-693	692-693
GPS Mounts	693	693	693	693	693
Hand Control Lever Kits	36, 622	622	622	622	622
Hand Grips	580-608	580-608	580-608	580-608	580-608
Handlebar Amp and Speaker Kits	–	691	691	691	691
Handlebar Clamps	–	705	705	705	705
Handlebar Risers	–	650-651	650-651	650-651	650-651
Handlebars	36	634-636, 638-639	632-641	632-641	640-648
Hardware – Chrome	33, 39, 568-573	568-573	568-573	568-573	568-573
Hardware Covers	–	568-572	568-572	568-572	568-572
Harley® Detailing Kit	816	816	816	816	816
Harley Hammock Touring Seats	–	–	–	177	332-333
Harley Travel Care Kit	816	816	816	816	816
Harley Wash Bucket	814	814	814	814	814
Harley Bike Wash Kit	816	816	816	816	816
H-D® Detachables™	–	74-75	120-122	235-236	345-347, 352-353, 360-362
H-D Motor Co. Engine Trim Collection	–	545	545	545	545
Headbolt Covers/Bridges	–	567	567	567	567
Headlamp Bulbs	715	715, 717	714-721	714-721	714-721
Headlamp Housings	35	724	724	724	–
Headlamp Nacelles	–	–	–	205, 266, 729	–
Headlamp Trim Rings	–	724-730	724-730	208, 724-730	724-730
Headlamp Visors	35	64, 730	111, 730	730	730
Headlamps – LED	715	715, 717	714-717	714-718	714-717
Headsets	685-687	685-687	685-687	685-687	685-687
Heated Hand Grips	606-607	606-607	606-607	606-607	606-607
Heated Seats/Backrests	–	–	–	–	329, 333, 358
Heavy Breather Air Cleaners	–	498	468-470	445, 468-470	445, 468-470
Helmet Headsets	685-687	685-687	685-687	685-687	685-687
Helmet Locks	826	826	826	826	826

Product	V-ROD®	SPORTSTER®	DYNA®	SOFTAIL®	TOURING
Heritage Saddlebag Quick Detach Kit	-	-	-	246	-
High-Flow Air Cleaner	-	-	474	447-448, 474	447-448, 474
High-Output Alternator Kits	-	-	-	-	427
Highway Peg Mounting Kits	612-615	612-615	612-615	612-615	612-615
Hog Ties® Straps	824	824	824	824	824
HOG® Booster Portable Charger	842	842	842	842	842
HoldFast™ Docking Hardware	-	-	-	185	-
HoldFast Luggage Racks	-	-	-	189-190	-
HoldFast Sissy Bar Uprights	-	-	-	186	-
HoldFast Tour-Pak® Mounting Rack	-	-	-	197	-
Hollywood Handlebar	-	635	635	635	-
Horn Covers	-	749	749	749	749
Horn Kits	749	749	749	749	749
Inner Fairing – Color-Matched	-	-	-	-	796-797
Inner Fairing Trim Kits	-	-	-	-	402-409
Inner Primary Cover – Chrome	-	-	554	548, 554	548, 554-555
iPod® Mounts/Accessories	690, 893	690, 893	690, 893	690, 893	690, 893
Jiffy Stands and Extensions	38	91	131	260	375
K&N® Air Filters and Care Products	-	508, 847	508, 847	508, 847	508, 847
Keyed-To-Match Keys	830	830	830	830	830
Kahuna™ Collection	584-585	536-537, 584-585	584-585	536-537, 584-585	584-585
King Size Windshields	-	-	-	170-171, 219-221	305-307
Knee Pads – Tank	-	59	118	183, 233	-
Knockout Custom Wheel Kit	-	-	-	-	755
Leather Rejuvenator	813	813	813	813	813
Leather Badlander Seat	-	69	115	229	336
LED Headlamps	715	715, 717	714-717	714-717	714-717
LED King Tour-Pak Brake/Turn/Tail Lamp Kit	-	-	-	-	419
LED Tail Lamps	745	744-745	744-745	744-745	419-423, 740-745
LED Turn Signals	-	733	733-734	733-735	733-736
License Plate Frames	747-748	747-748	747-748	747-748	747-748
License Plate Hardware	748-749	748-749	748-749	748-749	748-749
License Plate Mounts – Layback	-	746-747	746-747	746-747	746-747
License Plates – Side Mount	-	103	142	-	-

866 INDEX

Product	V-ROD®	SPORTSTER®	DYNA®	SOFTAIL®	TOURING
Lifter Covers	-	-	557	557	557
Lighted Hand Controls	-	-	-	-	628
Limited Paint Sets	-	-	-	786-787	784-787
Live To Ride Engine Trim Collection – Gold	-	544	544	544	544
Live To Ride Medallions	805	805	805	805	805
Locks and Cables	725-727	725-727	725-727	725-727	725-727
LongBlock Program	-	-	520-521	520-521	520-521
Lower Fork Sliders	-	94	135	204	388
Lubes and Cleaners	832-839	832-839	832-839	832-839	832-839
Luggage – Trike	-	-	-	-	370-371
Luggage Rack	32	78-79	123-124	189-191, 238-240	351-354, 363-367
Luggage Racks – HoldFast™	-	-	-	189-190	-
Master Cylinder Cover Kits	37, 623, 626	623, 626-627	623, 626-627	623, 626-627	623, 626-627
Master Cylinder Covers – Rear	-	-	627	627	378, 627
Master Cylinder Reservoir Kits	37, 623	623-627	623-627	623-627	623-627
Medallions	804-805	804-805	804-805	804-805	804-805
Messenger Bags	774	774	774	774	774
Michelin® Tires	854-855	854-855	854-855	854-855	854-855
Microfiber Detailing Cloth	815	815	815	815	815
Microphone – CB	-	-	-	-	687
Mid-Control Kits	-	90	129-130	-	-
Mid-Frame Air Deflectors/Trim	-	-	111	222	321
Milwaukee Eight® Engine Trim	-	-	-	532-535, 548-549	532-535, 548-549
Mini Footboard Kits	612	612	612	612	612
Mirrors	618-621	618-621	618-621	618-621	618-621
Mirrors – Bar End	20, 57, 618	20, 57, 618	20, 57, 618	20, 57, 618	20, 57, 618
Motorcycle Covers	817-819	817-819	817-819	817-819	817-819
Motorcycle Oil	832-838	832-838	832-838	832-838	832-838
Mud Flaps	-	-	-	279	418
Muffler Clamp	39	-	-	-	-
Muffler End Caps	-	502	-	450, 452-453, 479	457, 458, 482
Muffler/Exhaust Mount Cover Kits	-	-	-	-	482
Mufflers	-	501	476-477	450-454, 478-479	456-459, 480-483
Music Player Tank Pouch	693, 779	693, 779	693, 779	693, 779	693, 779

Product	V-ROD®	SPORTSTER®	DYNA®	SOFTAIL®	TOURING
Mustache Engine Guards	–	93	134	203, 259	384
Navigation Interface Module	–	–	–	–	693
Nostalgic Grip/Peg Collection	603, 607	603, 607	603, 607	603, 607	603, 607
Oil Change Kits	835	835	835	835	835
Oil Cooler Covers	–	–	144	205, 276	394
Oil Cooler Fan Kit	–	–	–	–	323
Oil Cooler Kits	–	100	144	276	323
Oil Dipsticks with Temperature Gauge	39	101, 565	565	565	565
Oil Drain Pan	835	835	835	835	835
Oil Filter Wrenches	837	837	837	837	837
Oil Filters	834	834	834	834	834
Oil Funnels	836-837	836-837	836-837	836-837	836-837
Oil Pressure Gauges	–	–	699	699	698-699
Oil Pump	–	–	486	486	486
Oil Tank Covers	–	102	–	–	–
Oil Temperature Gauge	39	101, 565	565	565	565, 698-699
One-Piece Sissy Bar Uprights	–	75	121	187	–
Organizer – Tour-Pak®	–	–	–	–	369-370
Pagers – Security	831	831	831	831	831
Paint Guard Kits	–	–	–	196	429
Paints	803	803	803	803	803
Passenger Armrests	–	–	–	–	340
Passenger Backrest Pads	32-33	75-76	116, 121-122	187-188, 236-237	335, 348-350, 357-359
Passenger Footboard Covers	–	–	–	611	382-383
Passenger Footboard Brackets	–	–	–	202, 258	–
Passenger Footboard Supports	–	–	132	202, 258	380-381
Passenger Footboards – Adjustable	–	–	–	–	381
Passenger Footboards/Pans	–	–	132, 610-611	258, 610-611	382-383, 610-611
Passenger Footpeg Mounts	613	92, 613	132, 613	202, 257, 613	380, 613
Passenger Grab Rails	–	–	–	230	341
Passenger Pillions	32	67, 71	114, 116	180, 227, 230	331, 337
Phone Mounts	690	690	690	690	690
Piggyback Shocks – Screamin' Eagle®	–	87	–	–	–
Polished Brake Rotors	766	765-766	765-766	765-766	757, 759, 765-766

868 INDEX

Product	V-ROD®	SPORTSTER®	DYNA®	SOFTAIL®	TOURING
Power Switches	-	-	-	-	428
Power Port – 12V	-	694	694	694	694
Premium Emulsion Shocks	-	88	128	-	387
Primary Cover Trim – Chrome	-	-	554-555	554-555	548, 680-681
Profile® Low Suspension	-	88	-	198, 252	386-387
Pushrod Covers	-	-	557	549, 557	549, 557
Pushrods	-	-	485	485	485
Quarter Fairing	-	64	111	-	-
Quick Wash	810	810	810	810	810
Radio and Gauge Trim	-	-	-	-	402-409
Rail Collection Engine Trim	-	558	-	-	-
Rain Covers – Seats	820	820	820	181, 820	820
Razor-Pak Luggage	-	-	-	-	356
Reach Seats	31	66	113	174-175, 224-225	326-327
Reach® Handlebars	36	638	632	632-633	643, 645
Rear Set Foot Controls	-	58	-	-	-
Reduced Effort Clutch Kit	-	-	627	627	627
Remanufacturing – Engines	-	-	520-521	520-521	520-521
Replacement Windshield Screens	-	-	-	222	305
Rider Backrests	-	67, 71	118	177	329, 338-339
Rider Footboards/Inserts	-	-	580-605, 610-611	580-605, 610-611	580-605, 610-611
Riser and Clamp Kits	-	650-651	650-651	650-651	650-651
Riser Bushings/Hardware	-	651	651	651	651
Road Glide® Windshields	-	-	-	-	314-315
Road Zeppelin® Seat Pads	-	72	118	181, 232	342
Road Zeppelin® Seats	-	-	-	-	334-335
Saddlebag – Heritage Flat Top Kit	-	-	-	246	-
Saddlebags – Black Standard Line	-	84	-	194, 248	-
Saddlebag Bottoms – Stretched	-	-	-	-	794
Saddlebag Coolers	-	-	-	-	371, 775
Saddlebag Filler Strip Kits	-	-	-	-	417, 800
Saddlebag Guard Bags	-	-	-	-	372
Saddlebag Guard Kits	-	-	134	203, 260	364-367
Saddlebag Latches	-	-	-	-	416

Product	V-ROD®	SPORTSTER®	DYNA®	SOFTAIL®	TOURING
Saddlebag Lid Bra	-	-	-	-	373
Saddlebag Lid Rails	-	-	-	-	365
Saddlebag Lighting	-	-	-	-	743-745
Saddlebag Liners	-	775	775	196, 243, 775	370-371, 775
Saddlebag Lock Kits	-	827	127, 827	243, 827	416, 827
Saddlebag Matrix	-	80-81	-	-	-
Saddlebag Storage Stand	-	-	-	-	816
Saddlebag Supports	-	85	127	194, 248	366
Saddlebags	-	80-85	125-127	192-195, 241-248	420-423, 775
Saddlebags – Detachable	-	82	125	192-194, 241-243	-
Saddlebags – Hard	-	-	-	-	775
Saddlebags – Throw Over	-	84-85	127	194, 248	-
Saddlebags – Trike	-	-	-	-	370
Scratch & Swirl Repair	812	812	812	812	812
Screamin' Eagle® – Twin Cam	-	-	466-495	466-495	466-495
Screamin' Eagle Performance	-	438-439, 496-506	438-439, 466-495	438-439, 445-495	438-439, 445-495
Screamin' Eagle Suspension	-	86-87	-	-	-
Screamin' Eagle – Milwaukee-Eight™	-	-	-	440-465	440-465
Screamin' Eagle – Sportster®	-	496-506	-	-	-
SE120ST Engine	-	-	-	-	513
Seat Pads	-	72	118	181	342-343
Seats	31	66-71	113-118	173-183, 224-233	326-343
Seats – Badlander®	-	69	115	173, 229	336
Seats – Brawler®	-	68	115	173, 229	336
Seats – Harley® Hammock	-	-	-	177	332-333
Seats – Low Profile	-	-	116	173, 229	336-337
Seats – Reach®	31	66	113	174-175, 224-225	326-327
Seats – Road Zeppelin®	-	-	-	-	334-335
Seats – Signature Series®	-	67	114	228	329
Seats – Spring	-	70	117	182, 231	-
Seats – Sun Ray®	-	-	-	-	329
Seats – Sundowner™	31	67-68	114	178-179, 226-227	330-331
Seats – Super Reach®	-	66	113	224	326
Seats – Tallboy®	-	66	113	176, 225	328

870 INDEX

Product	V-ROD®	SPORTSTER®	DYNA®	SOFTAIL®	TOURING
Security Systems	828-829	828-829	828-829	828-829	828-829
Service Covers	821	821	821	821	821
Service Lifts	823	823	823	823	823
Shift Levers	38	–	131	200-201, 253	377-378
Shift Linkages/Covers	–	91	–	201, 255	379
Shifter Pegs and Footpegs	580-609	580-609	580-609	580-609	580-609
Shocks	–	86-88	128	198, 252	386-387
Side Covers – Cut Back	–	59, 101	–	–	–
Side Covers – Extended	–	–	–	–	793
Side Mount License Plate	–	103	142	–	–
Signature Series Seats	–	67	114	228	329
Sissy Bar Bags	–	771-774, 776-777	771-774, 776-777	771-774, 776-777	771-774, 776-777
Sissy Bar Uprights	32	74-75	116, 119-121	186-187, 235-236	344, 346-347
Sissy Bar Uprights – HoldFast™	–	–	–	186	–
Sissy Bar Locks	–	77, 827	827	827	827
Skull Grip/Peg Collection	596-597, 607	596-597, 607	596-597, 607	596-597, 607	596-597, 607
Soft Hooks	824	824	824	824	824
Soft Lowers	–	93	111	259	320
Solo Racks	–	79	124	191, 240	353, 360
Spark Plug Wires	–	510	510	510	510
Spark Plugs	848	509, 848	509, 848	509, 848	509, 848
Speaker Trim – Chrome	–	–	–	–	402-409
Speakers	–	691	691	691	656-680, 691
Special Tools	844-845	844-845	844-845	844-845	844-845
Speedometer/Tachometer Gauges	–	100, 696	696-697	696-697	696-699
Split Vision Mirrors	620	620	620	620	620
Spoilers	–	59	111	–	420, 801
Spoilers – Saddlebag Lid	–	–	–	–	420, 801
Spoilers – Tour-Pak®	–	–	–	–	420, 801
Sport Windshields	–	61, 63	110	167, 217	306
Spray Cleaner & Polish	810	810	810	810	810
Spring Saddles	–	–	–	231	–
Spring Seats	–	70	117	182, 231	–
Sprocket Bolt Covers	–	99	–	–	–

Product	V-ROD®	SPORTSTER®	DYNA®	SOFTAIL®	TOURING
Sprocket Covers	-	-	142, 764	764	-
Sprocket Hardware	-	99, 764	142, 764	764	-
Sprockets	-	-	764	764	-
Stage Kits	-	505-506	490-493	460, 463-644, 488-495	460, 463-644, 488-495
Starters/Covers	-	566	566	566	566
Steer Stem Bolt Covers	-	96	137	210	-
Storage Covers	817-820	817-820	817-820	817-820	817-820
Streamliner Grip/Peg Collection	604, 608	604, 608	604, 608	604, 608	604, 608
Street Tuner	-	438-439	438-439	438-439	438-439
Sun Ray® Heated Seats/Backrests	-	-	-	-	329, 358
Sundowner™ Seats	31	67-68	114	178-179, 226-227	330-331
Sunwash® Bike Soap	810	810	810	810	810
Super Sport Windshields	30	61	107, 110	167, 217	-
Suspension Air Pumps	-	-	-	-	387
Suspension Kits	-	86-88	128	198, 252	386-387
Swingarm – Chrome	-	97	-	271	-
Swingarm Bags	-	85	127	195, 247	-
Swingarm Pivot Bolt Covers	34	98	-	213, 273	-
Switch Cap Kits	37, 625	625, 628-629	625, 628-629	625, 628-629	625, 628-629
Switch Housing Kits	37, 624, 628	624, 628	624, 628	624, 628	624, 628
Switch Panel Accent Cover	-	-	-	-	409
SYN3® Synthetic Oil	833	833	833	833	833
Tail Lamp Visors	-	746	746	746	746
Tail Lamps – LED	745	744-745	744-745	744-745	740-746
Tail Light – Tri Bar	-	-	745	745	743
Tallboy® Seats	-	66	113	176, 225	328
Tank Knee Pads	-	59	118	183, 233	-
Tank Panels	-	102	145	250	-
Tank/Air Box Bra	33	72	145	233	373
Tappet Block Trim	-	561	555, 557	555, 557	555, 557
Tappets	-	504	485	485	485
Thermometers	705	705	705	705	705
Throw-Over Saddlebags	-	84	-	194, 248	-
Tie-Down Brackets	-	-	-	267	397

872 INDEX

Product	V-ROD®	SPORTSTER®	DYNA®	SOFTAIL®	TOURING
Tie-Down Straps	824	824	824	824	824
Timer Covers	–	528-546	528-546	528-546	528-546
Tire Pressure Gauges	850-851	850-851	850-851	850-851	850-851
Tires	852-855	852-855	852-855	852-855	852-855
Tool Boxes	–	–	–	251	–
Tool Kits	844-845	844-845	844-845	844-845	844-845
Touring Luggage	770-775	770-775	770-775	770-775	371-372, 770-775
Touring Windshields	30	62	110	219-221	305-310, 314-316
Tour-Pak® – King	–	–	–	–	798-800
Tour-Pak – Leather	–	85	–	196, 249	356
Tour-Pak Brake/Tail Lamp Kit	–	–	–	–	419
Tour-Pak Conversion Kit	–	–	–	–	362
Tour-Pak Hinges/Latches	–	–	–	–	414-415
Tour-Pak Interior Light Kit	–	–	–	–	424
Tour-Pak Lid Tether	–	–	–	–	415
Tour-Pak Liners	–	–	–	–	368-369
Tour-Pak Luggage Rack	–	85	–	–	363-367
Tour-Pak Mounting Rack	–	85	–	197, 249	360-362
Tour-Pak Mounting Rack – HoldFast™	–	–	–	197	–
Tour-Pak – Chopped	–	–	–	–	798-800
Transmission and Primary Lubricant	832-833	832-833	832-833	832-833	832-833
Transmissions – Evolution®	–	–	517	517	517
Transmissions – Twin Cam	–	–	517	517	517
Transmissions and Gear Sets	–	–	517	517	517
Travel-Paks	–	775	775	775	775
Triple Tree Covers	–	–	137	–	–
Trunk Door Organizer	–	–	–	–	369
Trunk Guard	–	–	–	–	418
Turn Signal Kits – LED	–	733	733-734	733-735	733-736
Turn Signal Lens Kit	734	731, 861-862	731, 861-862	731, 861-862	731, 861-863
Turn Signal Trim Rings	731	731	731	731	730-731
Turn Signal Relocation Kit	–	64	125	192, 241, 243	–
Twin Cam Short Block	–	–	516	516	516
Ultra Boom!™ Bagger Kits	–	–	–	–	660, 677

Product	V-ROD®	SPORTSTER®	DYNA®	SOFTAIL®	TOURING
USB Charging Adaptors	694	694	694	694	694
Valve Springs	–	–	611	611	611
Valve Stem Caps	767	767	767	767	767
Valve Stem Extension	851	851	851	851	851
Ventilator Air Cleaner	–	–	471-472	446, 471-472	446, 471-472
Voltage Regulator Covers	–	–	144	276	398
Voltage Regulators	–	–	–	276	427
Wash Mitt	814	814	814	814	814
Water Pump Covers	–	–	–	–	394
Wheel and Spoke Brush	814	814	814	814	814
Wheel and Tire Cleaner	811	811	811	811	811
Wheel Installation Kits	763	763	763	763	763
Wheel Spacers – Front	–	–	138	263	390
Wheel Weights	767	767	767	767	767
Wheels	35	–	–	761-762	755-760
Wheels – Agitator	–	–	–	–	757
Wheels – Enforcer	–	–	–	–	758
Wheels – Impeller	–	–	–	–	759
Wheels – Knockout™ Kit	–	–	–	–	756
Wheels – Machete	–	–	–	758	–
Wheels – Nine-Spoke	–	–	–	762	–
Wheels – Slicer	–	–	–	–	758
Wheels – Thomahawk™	–	–	–	–	755
Wheels – Trike	–	–	–	–	758
Wheels – Turbine	–	–	–	761	760
Whiskers Highway Bar	–	–	–	260	–
Willie G Skull Engine Trim Collection – Chrome	–	542	542	542	542
Willie G Skull Engine Trim Collection – Black	–	543	543	543	543
Willie G Skull Grip/Peg Collection – Chrome	596-597, 607	596-597, 607	596-597, 607	596-597, 607	596-597, 607
Wind Splitter Windshields	–	–	–	167, 169, 221	306, 308, 314
Windshield Bags	–	776-777	776-777	776-777	820
Windshield Clamps – Locking	827	64, 827	827	222, 827	–
Windshield Storage Bags	820	820	820	820	820
Windshield Trim – Batwing Fairing	–	–	–	–	312-313

874 INDEX

Product	V-ROD®	SPORTSTER®	DYNA®	SOFTAIL®	TOURING
Windshield Trim – Road Glide®	–	–	–	–	316-317
Windshield Water Repellent	811	811	811	811	811
Windshields – Compact	30	62-63	108-109	168-169, 218	306
Windshields – Electra Glide®	–	–	–	–	308-310
Windshields – King Size	–	–	–	170-171, 219-220	305-307
Windshields – Replacement Screens	–	–	–	222	305
Windshields – Road Glide	–	–	–	–	314-315
Windshields – Sport	30	61, 63	110	167, 217	306
Windshields – Super Sport	30	61	107, 110	167, 217	–
Windshields – Touring	30	62	110	219-221	305-310, 314-316
Windshields – Wind Splitter	–	–	–	167, 169, 221	306, 308, 314
Wireless Headsets	683-686	683-686	683-686	683-686	683-686
Wireless Interface Module	–	–	–	–	684
Wrapped Front Fender	–	–	–	–	790
XR1200 Windshield	–	63	–	–	–
Z-Bar Handlebar	–	636	636-637	636-637	636-637
zūmo® GPS	692-693	692-693	692-693	692-693	692-693

10500093	72, 118, 183, 233, 341
10800055	705
10800056	705
10800057	705
10800058	705
11100078	429
11100080	429
11100097	429
11100098	429
11100125	429
11100222	196
11100225	196
11300002	839
11300004	842
11300005	838
12600036	77, 121, 240, 345
12700020	850
12700096A	850
14093-84	804
14100434	262, 390
14100618	145, 277, 400
14100747	401
14100748	401
14100749	401
14900033	845
14900091	837
16200070	519
16200071	519
16200085	520
16200086	520
16200087	520
16200088	520
16200091	520
16200092	520
16200093	520

16200094	520
16200095	520
16200096	520
16200097	520
16200098	520
16200099	520
16200100	520
16200101	520
16200102	520
16200103	520
16200104	520
16200105	520
16200106	520
16200108	520
16200109	520
16200162	520
16200163	520
16200164	520
16205-10	557
16213-10	549, 557
16295-07A	560
16400020	561
16400022	561
16400055	557
16400056	549, 557
17528-92	554
17529-92	554
17530-92	554
17537-07A	560
17537-96C	560
17551-04	560
17572-99	551
17573-99A	551
17618-99A	553
17620-99	553
17645-07A	559

17655-05	559
17707-11	550
17709-11	550
17900032	485
17900033	485, 557
17900058	462
17900073	462
17900076	485, 557
17900081	549
17900083	561
17900084	561
17964-99	551
17966-99	551
18013-03A	485, 504
18100080	462
18404-08	485
18572-13	485, 504
19221-15	513
24017-10	486
24018-10	486
25127-04A	544
25130-04A	545
25213-04	560
25247-99	551
25282-11	486
25284-11	486
25307-06	559
25331-10	541
25333-10	541
25338-99A	545
25340-99A	544
25364-01B	553
25369-01B	551
25400117	484
25400125	504
25400199	461

25400200	461
25400201	461
25400202	461
25440-04A	542
25441-04A	542
25454-01	546
25460-04	560
25460-06	560
25460-94	560
25482-10	484
25486-05	559
25562-09	540
25563-09	540
25600033	23
25600034	21
25600044	22
25600046	539
25600047	539
25600057	538
25600059	538
25600060	558
25600064	540
25600065	541
25600066	542
25600067	544
25600068	545
25600074	550
25600081	538
25600085	543
25600087	543
25600089	543
25600097	546
25600098	532
25600099	539
25600108	536
25600109	536

25600114	537
25600115	537
25600117	465
25600118	465
25600119	465
25600120	465
25600121	465
25600122	465
25600123	465
25600124	465
25600125	465
25600132	465
25600142	546
25638-07	484
25700007	394
25700020	546, 550
25700021A	550
25700180	550
25700249	552
25700250	552
25700251	552
25700307	23
25700308	21
25700337	555
25700385	551
25700388	546
25700434	540
25700435	541
25700438	550
25700446	552
25700460	22
25700467	532
25700469	542
25700472	544
25700476	545
25700477	532, 546, 550

25700491	532
25700504	539
25700505	539
25700506	539
25700515	538
25700517	538
25700520	532
25700521	532
25700531	558
25700532	558
25700533	558
25700541	558
25700571	535
25700572	533
25700573	534
25700600	558
25700602	534
25700604	534
25700631	548
25700632	548
25700633	394
25700634	394
25700653	557
25700654	548
25700661	535
25700663	535
25700703	535
25700704	534
25700705	533
25700710	533
25700712	533
25700722	528
25700740	543
25700742	543
25700744	543
25700750	532

876 PART#/PAGE# REFERENCE

25700768	528	25700967	538	26800152	322	29200102ECJ	797	29400021	508, 847	29400230	471
25700777	529	25700968	547	26900108	25	29200102ECL	797	29400022A	508, 847	29400232A	499, 558
25700779	528	25700969	539	27040-88T	566	29200102ECN	797	29400042	846	29400233	474
25700780	529	25700970	547	27300139	508, 847	29200102EEO	797	29400061A	470, 498	29400234	474
25700791	530	25700971	532, 547	27539-08A	491	29200102EEP	797	29400063	473	29400235	474
25700792	530	25700972	547	27543-08	490	29200102EEZ	797	29400064	473	29400236	474
25700793	530	25700973	547	27557-08	490	29200102EFC	797	29400065	508, 847	29400237	474
25700795	531	25700976	543	27564-09A	490	29200102EFD	797	29400078	846	29400238	474
25700796	531	25700987	537	27794-08	848	29200102EFF	797	29400103	473	29400239	474
25700804	531	25700988	536	27956-10	447, 541	29200102EFH	797	29400104	473	29400240	474
25700805	531	25701039	547	28714-10	508, 847	29200102EFM	797	29400109	508, 847	29400245A	445
25700806	531	25701040	547	28716-10A	469	29200102EFP	797	29400116	473	29400246A	445
25700807	531	25701043	547	28720-10	470	29200102EFU	797	29400117	473	29400247	508, 847
25700822	529	25800055	532	28721-10	471	29200102EKA	797	29400118	508, 847	29400248	846
25700825	528	25800061	549	28722-10	471	29200102EKG	797	29400127	499, 559	29400263	443
25700826	529	25800062	549	28728-10	475, 500	29200102EKP	797	29400128	499	29400264	443
25700850	531	25800063	535	28739-10A	470, 498	29200102ELD	797	29400141	508, 847	29400267	846
25700851	531	25800065	534	28740-10A	470, 498	29200102ELE	797	29400163	472	29400275	508, 847
25700870	409	25800087	533	29000009A	500	29200102ELG	797	29400164	472	29400276	508, 847
25700887	536	25800089	23	29000019A	500	29200102ELI	797	29400167	472	29400293	508, 847
25700888	537	25800091	23	29000066	475, 552	29253-08C	469	29400168	472	29400297	508, 847
25700890	549	25800098	532	29006-09C	469	29259-86	846	29400172	468	29400298	444
25700900	547	25800100	22	29017-09	470	29259-91A	846	29400173	468	29400299	444
25700913	532, 547	25800114	22	29080-09A	498	29264-08A	498	29400178	475, 552	29400341	543
25700934	547	25913-99	569	29084-04DH	561	29291-95	846	29400197	26	29400343	22
25700937	547	26082-05C	323	29098-09A	469	29299-08A	469	29400212	846	29400345	543
25700941	547	26151-07B	144	29119-08	475	29314-08	846	29400217	471	29400350	26
25700958	542	26155-07A	323	29138-91A	564	29319-08	475	29400218	471	29400355	446
25700959	545	26155-09A	323	29153-07	560, 564	29325-95A	846	29400219	471	29400356	446
25700960	540	26157-07A	276	29170-08	475	29328-99	447, 544	29400220	473	29400357	446
25700961	544	26157-11A	276	29191-08	846	29331-04	846	29400221	473	29400358	508, 847
25700962	535	26792-01	39	29200008A	222	29331-96	846	29400222	474	29400359	508, 847
25700963	533	26800119	838	29200011	111	29377-08	846	29400223	472	29400363	447
25700964	534	26800120	322	29200102DH	797	29400015	846	29400224	472	29400366	447, 543
25700965	528	26800121	322	29200102DZT	797	29400019	508, 847	29400227A	498	29416-04	542
25700966	529	26800128	322	29200102DZW	797	29400020	508, 847	29400228	498	29417-04	447, 542

29424-05B	508, 847	31600109	510	32337-04	848	33600001	254, 377	34018-08	201, 255, 379	35495-06	254
29431-97	566	31600110	510	32338-04	848	33600032A	19, 601	34023-08	254, 377	36500131	548
29437-01A	846	31600111	510	32342-04	848	33600059	19, 601	34043-10	131, 253	36700004	622
29462-99	846	31600112	510	32359-00C	510	33600075	598	34045-10	254, 377	36700052	622
29493-05A	447	31600113	510	32360-00C	510	33600076	377	34469-01	551	36700053A	622
29503-07	475	31619-06A	556	32362-04A	848	33600093	18, 594	34469-06B	551	36700064	622
29509-06	846	31621-06A	556	32365-04	848	33600100	19, 591	34469-99B	551	36700065	622
29510-05	475	31709-04	144	32367-04	848	33600111	19, 587, 589	34521-06B	553	36700066	622
29586-06	475	31783-00	556	32414-09	540	33600154	599	34535-00B	254, 377	36700067	622
29600-00	569	31901-08A	510	32415-09	540	33600164	200	34539-00	131, 253	36700091	622
29624-08	475	31902-08A	510	32519-10	541	33600165	200	34541-00	551	36700094A	626
29633-08	846	31907-08A	510	32520-10	541	33600166	200	34551-09	38	36700100	623
29702-08B	508, 847	31930-99C	510	32581-90TB	544	33600167	200	34608-95	602	36700104	622
29703-00	569	31932-99C	510	32584-88TA	546	33600168	200	34627-99	603	36700105	622
29765-01	564	31937-99C	510	32585-90T	544	33600169	200	34633-85T	609	36700119	626
29782-07	500	31939-99C	510	32668-98A	545	33600180	17, 580	34635-90T	609	36700209	622
29784-07	505	31944-99C	510	32677-01	546	33600214	17, 581	34671-10	18, 593	36700210	622
29823-04	544	31946-99C	510	32679-99A	546	33600215	17, 582	34689-04	597	36700211	622
29900028A	427, 695	31956-04B	510	32689-99A	544	33600216	17, 582	34690-08	20, 600	36808-05	627
29903-07A	491	31958-04B	510	32690-99A	569	33600217	17, 582	34760-04	546, 560	37000026	516
29985-87	427	31963-89B	510	32700002	263, 762	33600218	17, 582	34761-04A	546, 560	37000121A	515
29999-97B	427	31964-89C	510	32714-98A	628	33600224	201	34790-05	546, 559	37000258	514
30003-10	505	31965-08A	510	32715-98	139, 270, 391	33600255	377	34794-05A	559	37000278	626
31335-03A	556	31967-08A	510	32745-99	567	33600256	18, 585	34800012	552	37000286	514
31400088	548	32042-07	555	32747-99	567	33600257	18, 584	34800026	552	37000287	514
31400090	548	32047-99A	545	32972-04A	542	33600259	201, 255, 379	34800031	532	37000288	514
31400092	557	32077-07	555	32975-04A	542	33760-09	201, 255, 379	34800032	558	37103-08	566
31559-99A	556	32092-98B	510	33045-03A	517	33778-09	91	34800047	528	37105-99	551
31600012	848	32093-98B	510	33100-03A	517	33801-09	201, 255, 379	34800048	529	37116-06	551
31600048A	26, 510	32095-98B	509	33101-03A	517	33814-98A	201, 255, 379	34840-09	91	37123-98A	566
31600051A	26, 510	32184-08A	436	33102-03A	517	33876-07	254, 378	34850-09	201, 255, 379	37135-06	553
31600054A	26, 510	32303-08A	510	33103-03A	517	33892-98	89	34856-06A	570	37189-99	553
31600085	509, 848	32318-08A	510	33111-02	556	33900186	378	34932-04	560	37193-11	550
31600105	509, 848	32325-08A	510	33137-04	517	33909-08A	253	34943-05	559	37195-11	550
31600106	509, 848	32335-04	848	33395-06A	89	33946-05	605	34967-04	604	37198-11	550
31600108	510	32336-04	848	33397-07A	89	34016-08	131, 253	35471-05	254, 378	37757-07	764

878 PART#/PAGE# REFERENCE

37938-08KA	516	41000087E	829	41451-08C	25, 763	41700262	623	41880-07	762	42701-05	605
37951-98	516	41000369	629	41453-08C	763	41700263C	623	42002-08	139	42710-04	597
37980-10	516	41000445	437	41454-08B	763	41700297	626	42012-06A	34, 390	42711-04	597
38002-04	516	41000460	829	41455-08C	763	41700324A	623	42029-07	849	42712-04	604
38752-04	517	41144-97	767	41456-08C	763	41700330	623	42047-08	139, 269	42739-08	849
38753-04A	517	41145-97	767	41500007	757, 765	41700334	626	42048-08	269	42831-04A	849
38843-08	622	41148-98	767	41500008	757, 765	41700421A	622	42054-05	34, 390	42836-04A	849
38845-08	622	41149-98	767	41500012A	34, 766	41700422A	622	42069-08	275	42847-10	18, 592
38853-08	622	41150-98	767	41500040	758	41700423A	622	42070-07	99	42850-06B	849
40006-85	844	41161-01	748	41500052	757, 765	41700424A	622	42072-07	98	42897-06A	849
40091-10	376	41170-03	748	41500053	757, 765	41700425A	622	42100-06D	37, 623	42897-08	849
40100061	515	41171-03	767	41500069	765	41700440	623	42114-06A	37, 626	43000018	25
40120-09	142, 764	41202-08	275	41500094	759, 766	41700441	623	42117-08A	623	43000026	24, 94, 136, 206, 264, 392
40121-09	764	41300004	849	41500095	767	41700442	626	42123-08	626	43000031	95, 136, 207, 264, 393
40225-10	757	41300027	849	41500096	25	41700463	623	42200007	764	43000046	24, 95, 136, 207, 265, 393
40789-08	762	41300033	849	41500097	25	41700480	623	42200064A	515	43000050	141, 212, 274
40900057	761	41300053	849	41500107	765	41704-09	141, 212, 274	42200066	764	43000051	274
40900070	758	41300061	628	41500108	765	41705-09	141, 212, 274	42200067	764	43000052	274
40900088	758	41300062	628	41500109	765	41706-09A	141, 212, 274	42200095A	515	43000057	98
40900324	761	41300072	849	41500110	765	41800004	253	42270-06B	36, 622	43000062	24, 95, 136, 206, 264, 392
40900332	758	41300102	849	41500120	756, 760, 765	41800005	253	42275-07A	36, 622	43000090	207
40900346	758	41300116	34, 390	41500147	756, 760, 765	41800220	839	42298-08	849	43000096	24, 95, 136, 207, 265, 393
40900348	759	41300127	139, 269	41597-00	138	41800610	16	42300009	851	43000108	213
40900358	25	41300134	99	41600012	376	41800611	16	42310-08	849	43000109	213
40900391	759	41300148	207, 269	41600079	376	41800770	839	42313-07	626	43000110	141, 212, 274
40900403	760	41300152	207, 269	41600082	376	41800771	839	42400003	763	43000111	213
40900405	760	41300154	34, 390	41600146	376	41800772	839	42400008	25, 763	43000123	24, 95, 136, 206, 264, 392
40900459	757	41300157	139, 269	41600208	376	41800773	839	42400009A	763	43000124	24, 95, 136, 206, 264, 392
40900622	760	41300161	849	41600215	200	41800774	839	42400010A	763	43000124	24, 95, 136, 206, 264, 392
40900623	755	41300169	849	41600216	200	41830-05A	766	42400016	390		
40900624	755	41300181	390	41600217	200	41831-05A	766	42476-95	602		
40955-05	139, 270, 391	41300196	849	41600218	200	41832-05A	766	42478-95	602		
40959-05	139, 270, 391	41300197	849	41600219	200	41843-08	627	42638-03	376		
41000008C	436	41300214	849	41600220	200	41850-08	20, 600	42638-08A	376		
41000018	436	41371-08	390	41600280	376	41852-08B	849	42679-01	613		
41000021F	829	41449-10	592	41700190	623	41854-08	849	42700-05	605		

43000128	141, 212, 275
43000129	141, 212, 275
43000159	207
43000163	213
43000166	213
43000167	213
43013-09A	98
43061-04	136, 393
43062-04	136, 393
43063-04	136, 393
43077-11A	763
43078-99	814
43132-08	141, 212, 274
43161-97	263
43163-08A	24, 95, 136, 207, 265, 393
43221-08	274
43235-08	273
43300010	263, 762
43300047	761
43300315	761
43300324	758
43300336	758
43300338	759
43300351	25
43300369	758
43300386	759
43300388	758
43300395	760
43300396	760
43300442	757
43300494	756
43300496	756
43300640	760
43300641	755
43300642	755
43422-09	141, 212, 274

43428-09	94, 136, 206, 264, 392
43430-09	34
43462-00	273
43634-08	35
43635-08	35
43822-01	567
43824-03	139
43833-07A	763
43834-98	139, 270, 391
43848-08A	763
43850-96	569
43851-11B	763
43854-08A	763
43858-00	567
43859-00	567
43861-08A	763
43864-96	393
43868-99	567
43876-04	99, 764
43878-08B	763
43881-96	569
43884-96	567
43896-99	567
43897-86B	273
43899-86A	94, 136, 393
43911-95	567
43957-86F	849
44063-83D	849
44082-00E	849
44082-08	849
44093-96	139, 391
44095-96	139, 391
44114-07	136, 206, 265, 393
44116-07A	94, 136, 206, 264, 392

44117-07A	24, 94, 136, 206, 264, 392
44148-07A	95, 136, 207, 264, 392
44209-87D	849
44248-96	603
44256-01	274
44345-09	275
44346-06	140
44357-00A	765
44358-00A	765
44359-00A	765
44360-00A	765
44367-00A	765
44368-00A	765
44392-00A	34, 99, 139, 390
44395-00A	99, 139, 269
44395-08	139, 269
44432-04	567
44473-02A	270, 391
44476-99	139, 270, 391
44477-99	139, 270, 391
44942-08A	765
44944-08A	765
44947-08A	765
44950-08	766
44959-08	766
44970-07	253
44992-07	622
44994-07	622
45075-07	622
45078-96D	37, 626
45149-99C	263, 378, 627
45281-99D	623
45284-99D	623
45310-98	261

45355-06A	623
45355-08	623
45400006	261
45400058	128
45400090	88
45400091	88
45400176	87
45400218	386
45400219	386
45400220	386
45424-08	561
45500014	261
45500015	261
45500064	135
45500065	135
45500066	135
45500067	135
45500106	386
45500141	252
45500157	386
45500158	386
45500167	388
45500171	388
45500172B	388
45500200	388
45500226	94
45500238	94
45500258	94
45500261	94
45500267	135
45500308	96, 137, 268
45500399	204
45500400	204
45500401	204
45500402	204
45500403	204

45500404	204
45500405	204
45500406	204
45500427	198
45500514	96, 137, 210, 268
45500515	96, 137, 210, 268
45500516	96, 137, 210, 268
45591-02	262, 389
45600022	389
45600023	389
45600031	389
45600032	389
45700041	210
45700042	210
45700049	210
45700050	210
45700051	210
45700054	385
45732-86	15, 826
45737-72A	825
45800010	135
45800011	135
45800014	138
45800015	137
45800022	389
45800034	389
45800035	389
45800036	389
45800037	389
45800038B	389
45800056	21
45800075	135
45800076	135
45800113	96, 210

45800117	96, 137, 210, 268
45800118	96, 137, 210, 268
45800126	210
45800133	205
45800134	205
45800135	205
45813-03	138, 270, 391
45848-03	138, 270, 391
45896-98	417
45963-97	262, 389
46089-98A	826
46097-98	138, 263
46098-98	624
46099-98	624
46109-06	137
46112-02F	37, 623
46114-07	36, 622
46129-98B	96, 137, 268
46192-99A	96, 138
46302-01	255
46303-01	379
46305-01	379
46318-04	825
46363-11	849
46399-05A	98
46418-05A	623
46424-05B	626
46425-05A	131, 263, 378, 627
46463-08	378, 627
46477-00	135, 261
46482-00	261
46546-03	388
46548-03	367
46549-03	384

880 PART#/PAGE# REFERENCE

46555-03B	728	49000005	93	49155-05B	384	50193-96	383, 611	50300135	190	50500167	614
46559-03	397	49000006	93	49155-09B	384	50194-96	383, 611	50300136	190	50500168	614
46562-04A	94	49000015B	15	49171-08	253	50198-97B	380	50300137	190	50500225	131, 256, 375
46565-04	366	49000047B	15	49179-09	367	50203-04	92	50300140	190	50500244A	601
46595-06A	35, 138	49000069	418	49184-09A	384	50210-06	132	50300154	191	50500245A	601
46646-05	767	49000077	134	49200-07A	259	50211-04	604	50300156	191	50500247	131
46647-05	767	49000078	134	49215-07	93	50227-01	131, 253	50300174	197	50500270	92
46718-08	600	49000105	385	49249-06	132	50246-00	383, 611	50300176	197	50500367	601
46809-09	266	49000114A	385	49261-00A	260	50300008A	352	50300186	197	50500386	130
46875-09	386	49000117A	385	49267-01A	38	50300009	239	50300188	197	50500403A	380
46889-06	138	49000138	203	49279-06	132	50300028	32	50300192	197	50500435	598
46944-07A	622	49000139	203	49282-09B	366	50300030	79, 124, 238	50357-04	132, 382, 611	50500436	598
47200240	320	49000140	203	49283-09	367	50300031	79, 124, 238	50370-04	597	50500437	598
47200278	397	49000141	203	49287-11	93	50300040	79	50377-07A	258	50500441	601
47300-88T	272	49002-98	133	49291-07	366	50300042A	353	50378-07B	382	50500482	595
47498-09	417	49004-00A	259	49312-10	18, 593	50300044B	351	50379-07B	382	50500492	711
47596-91B	275	49004-90	259	49320-09	134	50300054A	353	50396-05	605	50500495	711
47612-08	273	49010-06	134	49349-07	132	50300058A	353	50399-07A	258	50500515	590
47630-09	273	49018-88C	93	49360-08	260	50300066A	238	50400-07A	258	50500516	590
47647-09	34	49019-95	133	49388-09	38	50300071	13	50409-04	374	50500527	586
47649-09	273	49021-09	130	49440-10	259	50300076B	351	50420-05	604	50500528	586
47660-09	273	49023-02A	259	49442-10A	384	50300091	13	50454-09	257	50500533	591
47663-09	273	49037-05A	259	49500-92T	609	50300097	344	50459-06	258	50500535	19, 591
47951-10	757	49050-09A	384	49742-01A	38	50300099A	240	50460-06	258	50500536	587
48035-09	77, 121, 240, 571	49053-04A	91	50000008	260	50300116	238	50462-11	91	50500540	19, 587
48211-08	272	49060-04	93	50000023	375	50300120	191	50500-03	602	50500578	380
48212-08	272	49080-03A	130	50000032	131	50300123	12	50500030	593	50500640	588
48218-10	77, 121, 240, 571	49080-06A	130	50000091	260	50300124	189	50500035	600	50500655	589
48220-10	77, 121, 240, 571	49087-01	367	50000122	378	50300125	189	50500042	380	50500667	588
48221-10	77, 121, 240, 571	49102-86T	612	50113-10	600	50300126	189	50500109	92, 133, 257, 612	50500678	19, 589
48223-10	77, 121, 240, 571	49110-98	609	50130-95A	602	50300127	189	50500124	92, 133, 257, 612	50500690	595
48225-10	77, 121, 240, 571	49117-77TB	609	50131-95A	602	50300130	189	50500139	92, 133, 257, 612	50500691	199
48434-05A	97	49128-82	609	50176-95	602	50300131	189	50500144	92, 133, 257, 612	50500693	199
48452-00	272	49140-05B	259	50177-95	602	50300132	190	50500158	256, 374	50500695	199
48893-01	34	49144-86	612	50187-96	603	50300133	190	50500167	614	50500696	199
48983-09	38	49149-84A	609	50190-96	603	50300134	190	50500168	614	50500709	595

50500717	599
50500718	596
50500722	596
50500729	592
50500732	592
50500769	202
50500771	202
50500781	595
50500787	18, 595
50500791	595
50500797	590
50500798	586
50500799	588
50500803	591
50500804	587
50500805	589
50500806	591
50500807	587
50500808	589
50500831	591
50500832	587
50500833	589
50500837	199
50500839	199
50500840	199
50500851	593
50500856	597
50500857	593
50500858	597
50500869	580
50500870	580
50500871	580
50500872	581
50500873	581
50500874	581
50500928	582

50500929	582
50500930	582
50500931	582
50500937	17, 582
50500938	17, 582
50500939	17, 582
50500940	17, 582
50500947	17, 580
50500949	17, 581
50500967	593
50500988	595
50500992	580
50500993	581
50501008	591
50501009	587
50501010	589
50501020	593
50501113	202
50501114	202
50501117	202
50501118	202
50501128	202
50501148	18, 585
50501150	585
50501151	585
50501225	18, 584
50501227	584
50501228	584
50501265	599
50501266	599
50501558	580
50501559	581
50549-08	600
50576-05	605
50600104A	601
50600140	19, 601

50600159	598
50600165	598
50600169	18, 594
50600179	590
50600182	19, 590
50600185	588
50600186	586
50600187	19, 588
50600188	19, 586
50600232	599
50600248	590
50600255	586
50600256	588
50600257	590
50600258	586
50600259	588
50600266	580
50600267	580
50600268	581
50600269	581
50600290	583
50600291	583
50600292	583
50600293	583
50600294	583
50600295	583
50600296	583
50600297	583
50600311	597
50600313	597
50600317	592
50600318	592
50600338	599
50600340	585
50600341	584
50602-00A	258

50627-08	600
50631-04	375, 604
50634-05	256, 605
50683-04	610
50688-04	610
50695-08A	20, 600
50700001	778
50700002	778
50700005	130
50700007	130
50700008	130
50700020	89
50700021	89
50700026	90
50700027	90
50700028	90
50700030	90
50700040	58
50704-04	596
50710-04	596
50713-04	596
50716-04	132, 382, 611
50752-04	132, 382, 610
50763-09	92, 132, 380, 613
50768-07A	381
50782-91	383, 611
50789-99B	381
50807-08	132, 383, 611
50810-08	132, 383, 611
50827-07A	615
50828-07A	615
50829-07A	614
50830-07A	614
50832-07A	615
50855-09	260
50865-09	260

50903-85T	615
50911-08A	20, 600
50915-90T	609
50916-90T	609
50932-08	257
50957-02B	614
50964-98	615
51039-05	257
51060-08	375, 610
51074-10	12, 72, 118
51076-10	181, 232, 343
51078-10	12, 72, 118, 181, 232, 343
51099-02	237
51112-00B	227
51132-98	76, 122, 237
51146-10A	75
51161-10A	121
51168-10	120
51322-08	375, 610
51345-08	256, 610
51397-06A	229
51400-08	256, 610
51404-10	116
51468-06A	226
51469-06A	225
51470-06A	225
51471-06	113
51473-06A	114
51477-06	235
51507-04	68
51535-06A	116
51540-01A	114
51540-04	114
51540-06	114
51542-01B	330
51544-01A	68

51579-05A	349
51583-01	33
51587-05	237
51600-09	32
51607-09	32
51615-09A	330
51615-99C	330
51617-99C	331
51622-07	122, 237
51630-06	331
51630-09A	331
51631-09A	339
51633-06A	350
51634-06A	359
51638-97	118, 181, 232, 343, 820
51639-97	118, 181, 232, 820
51640-06	122, 237
51641-06	122, 237
51676-97A	72, 118, 183, 233, 341
51700-09	329
51718-06	329
51726-05	330
51727-05A	350
51732-10	75, 122
51734-10	71
51736-07	68
51737-07	66
51738-07	66
51739-07	68
51744-07A	71
51747-07	69
51749-07	69
51763-07	230
51764-06	226

882 PART#/PAGE# REFERENCE

51770-09	329	52000176	333	52000303	174	52225-89	231	52300285	13	52300446	186
51780-07	32	52000177	333	52000304	174	52265-01A	336	52300300	349	52300448	186
51782-07	33,116	52000183	330	52000305	176	52284-04	115	52300302	347	52300454	186
51783-07	33	52000201	334	52000314	182	52284-06	115	52300307	13	52300456	186
51804-02	233	52000203	67	52000315	182	52284-96A	115	52300312	358	52300502	187
51813-09	226	52000207	66	52000320	182	52288-06	113	52300314	358	52300503	187
51841-06	226	52000209	66	52000327	72, 118, 181, 232, 342	52292-00A	229	52300317	358	52300504	187
51898-05A	230	52000211	69	52000334	326	52292-94B	229	52300319	357	52300513	191, 827
51902-09	231	52000248	337	52000349	179	52296-94B	69	52300324A	344	52300514	191, 827
51922-09	228	52000249	337	52000350	179	52300016	32	52300334	359	52300518	191, 827
51928-01	331	52000252	328	52000352	175	52300018	74, 120, 235	52300335	357	52300519	191, 827
51929-01	331	52000253	326	52000353	175	52300020	74, 120, 235	52300353	345	52300555	188
51933-06	114	52000254	229	52000354	175	52300022	74, 120, 235	52300354	345	52300556	188, 348
51985-08	228	52000257	336	52000355	176	52300024	74, 120, 235	52300359	357	52300557	188, 348
51998-08	228	52000259	69	52000356	176	52300028	236	52300360	359	52300558	188, 348
52000003A	333	52000260	68	52000375	12	52300040A	75	52300361	349	52300559	188, 348
52000004A	333	52000266	115	52000381	182	52300042A	121	52300364	75	52300560	188, 348
52000011	227	52000267	229	52000429	178	52300044A	121	52300366	75	52300566	349
52000012	225	52000268	336	52000430	174	52300046A	121	52300376	185	52300567	357
52000014B	231	52000269	68	52004-25	231	52300049	120	52300377	185	52300572	357
52000015	114	52000276	70, 117, 231	52006-47B	231	52300050	120	52300378	185	52300573	349
52000034	67	52000277	70, 117, 231	52017-08	72	52300065	119	52300379	185	52300574	359
52000048	31	52000278	70, 117, 231	52018-08	233	52300070A	120	52300401	235	52300617	188
52000049	31	52000279	70, 117, 231	52036-08	118	52300103	118, 181, 232, 343	52300403	75	52300642	339
52000057	337	52000290	177	52038-08	233	52300105	343	52300409	177	52333-97E	335
52000062	67	52000291	178	52066-97C	336	52300140	778	52300415	344	52335-97A	335, 359
52000072	333	52000292	178	52067-08A	336	52300141A	349	52300432	186	52347-97	76, 122, 237
52000075	333	52000293	178	52093-08A	330	52300146	347	52300433	186	52348-97	76, 122, 237
52000098	227	52000294	177	52095-08A	336	52300147	347	52300434	186	52359-06	115
52000099	224	52000295	179	52099-09A	328	52300239	234, 242	52300435	186	52378-07	116
52000123	11	52000297	173	52100016	70	52300243	234, 242	52300436	186	52395-03B	358
52000124	11	52000298	173	52100029	183	52300245	71	52300437	186	52400039	230
52000128	330	52000299	173	52100043	183	52300257	347	52300439	186	52400040	337
52000133	329	52000300	173	52124-09A	120	52300258	347	52300441	186	52400053	67
52000135	329	52000301	173	52200003	826	52300281	13	52300442	186	52400066	227
52000168	11	52000302	174	52200004	826	52300283	13	52300444	186	52400073	340

52400090	341	52610-09A	346	53000063	363	53000399DHC	798	53000402EEZ	798	53000652EJH	799
52400091	341	52612-95	76, 122, 237	53000130	415	53000399DWC	798	53000402EFC	798	53000653EGW	799
52400106	340	52619-08A	327	53000131	414	53000399DZN	798	53000402EFD	798	53000654EHA	799
52400121	67	52626-04	76, 122, 237	53000195	415	53000399DZS	798	53000402EFF	798	53000654EJC	799
52400125	71	52627-09A	346	53000217	415	53000399DZT	798	53000402EFH	798	53000660EGY	799
52400127	71	52631-07	75, 121, 236	53000218	415	53000399DZW	798	53000402EFM	798	53000660EJK	785
52400128	180	52652-04	76, 122, 237	53000221	361	53000399ECN	798	53000402EFP	798	53000660ELF	799
52400129	180	52657-04B	350	53000225	360	53000399EEL	798	53000402EFU	798	53000660ELH	799
52400130	71	52689-09	116	53000229	364	53000399EEO	798	53000402EFW	798	53000661EHB	799
52400140	337	52709-97C	350	53000237	415	53000399EEP	798	53000402EKA	798	53000662EGY	799
52400141	337	52710-07	74	53000238	420	53000399EEV	798	53000402EKG	798	53000662ELF	799
52400162	72, 118, 181, 232, 342	52715-04A	258	53000239	420	53000399EEZ	798	53000402EKP	798	53000662ELH	799
52400168	180	52723-06A	346	53000242	364	53000399EFC	798	53000402EKR	798	53000663EHB	799
52400169	180	52726-09	116	53000247	364	53000399EFD	798	53000404	798	53000663EJB	799
52400170	180	52729-08A	236	53000252	414	53000399EFF	798	53000405	798	53000699EJE	799
52400171	180	52760-11	236	53000253	414	53000399EFH	798	53000431	372	53000699EJF	799
52400175	180	52796-09	124	53000291A	362	53000399EFM	798	53000459	361	53000700EJE	799
52400186	180	52825-05	188, 349	53000302	369	53000399EFP	798	53000521ECN	798	53000716EJF	799
52400225	180	52828-11	236	53000303	370	53000399EFU	798	53000527ECN	798	53000731ELD	798
52408-07A	348	52866-06A	120	53000322	368	53000399EFW	798	53000567	362	53000731ELE	798
52412-79A	76, 122, 237	52877-10	120	53000323	368	53000399EKA	798	53000570	197	53000736ELD	798
52423-09A	338	52886-98D	350	53000329	419	53000399EKG	798	53000574ECL	798	53000736ELE	798
52442-04A	225	52892-98B	358	53000330	419	53000399EKP	798	53000577ECL	798	53011-98	354
52447-96	343	52898-98A	357	53000343	414	53000399EKR	798	53000598	197	53015-05B	244
52501-09A	338	52900-09A	339	53000375EGA	799	53000402BYM	798	53000599	197	53051-09	333
52540-09A	235	52912-00	230	53000375EGC	799	53000402DHC	798	53000643EEM	799	53061-00B	244
52544-05A	327	52914-09A	339	53000375EGE	799	53000402DWC	798	53000646EEM	799	53066-00D	249
52546-09A	338	52915-07	230	53000375EGG	799	53000402DZN	798	53000649EGZ	799	53070-00A	380
52572-09A	339	52918-98B	336	53000377BHY	799	53000402DZS	798	53000649EJD	799	53075-03	234
52583-09A	339	52920-98B	350	53000377DSX	799	53000402DZT	798	53000649EJH	799	53086-04	188, 349
52587-09	339	52924-98B	350	53000377EGA	799	53000402DZW	798	53000650EGW	799	53111-96DH	800
52589-09A	339	52930-05	230	53000377EGC	799	53000402ECN	798	53000651EHA	799	53116-97DH	800
52591-09A	338	52933-97C	346	53000377EGE	799	53000402EEL	798	53000651EJB	799	53147-98C	356
52593-09A	338	52952-97	343, 820	53000377EGG	799	53000402EEO	798	53000651EJC	799	53209-09	249
52596-09A	338	52975-05	328	53000392	369	53000402EEP	798	53000652EGZ	799	53246-09C	362
52609-05	327	52976-05	328	53000399BYM	798	53000402EEV	798	53000652EJD	799	53249-01B	369

884 PART#/PAGE# REFERENCE

53260-09B	360	53913-04	74	54157-10	381	54651-05	252	55800591	645	56000042	621
53270-06DH	800	53919-04A	413	54171-11	415	54704-07	88	55800592	645	56000076	410, 616
53276-04A	361	53928-05	237	54187-10	592	54758-07	252	55800646	56	56000077	410, 616
53276-09B	361	53930-03B	234	54196-10	592	55070-11	757	55800647	56	56000080	619
53285-06	368	53931-03A	234	54205-09A	345	55071-11	757	55800668	56	56000081	619
53301-06	368	53932-03A	234	54213-09A	354	55798-10A	622	55800672	57	56000084	410, 617
53302-07	368	53953-06	238	54215-09A	353	55800035A	634	55800712	633	56000090	618
53303-07A	362	53959-06	234	54234-10	614	55800103	636	55800714	633	56000091	313, 617
53315-09	32	53961-06	119	54246-09A	345	55800188	633	55800715	632	56000098A	410, 616
53432-02	31	53963-10DH	800	54247-09A	346	55800198	636	55800717	632	56000099A	410, 616
53472-09A	353	53964-06B	119	54248-09A	346	55800224	16	55800719	633	56000133	20, 57, 618
53494-04A	79	53968-06C	119	54250-10	79	55800225	16	55800721	633	56000134	20, 57, 618
53511-06A	124	54000008	387	54256-10	235	55800252	639	55800748	640	56000135	620
53512-07A	79	54000016	98, 142	54258-10A	235	55800298	646	55800749	640	56000136	619
53528-95B	73	54000017	98, 142	54263-10	238	55800299	646	55800750	641	56000137	619
53529-04	73	54000041	252	54268-10	234	55800342	56	55800751	641	56021-04B	638
53532-02	73	54000066	128	54283-09A	352	55800345	638	55857-10B	641	56036-08	644
53543-95B	120	54000076	88	54290-11	78, 123, 238	55800386	642	55859-10B	640	56063-82A	651
53544-04	73	54000077	88	54291-11	78, 123, 238	55800421	637	55864-09	642	56066-82A	651
53559-04B	249	54000091	387	54292-11	239	55800422	637	55900023	651	56075-07	639
53566-09A	353	54000125	87	54296-11	234	55800430	636	55900074	634	56079-93T	639
53605-97	371, 775	54000134	198	54352-09	419	55800431	636	55900114	20, 57	56100007	608
53612-08A	240	54000143	198	54360-05	356	55800439	648	55900122	650	56100008	608
53618-05A	236	54000159	387	54376-10B	231	55800440	648	55900123	650	56100009	608
53655-04A	85	54000165	387	54380-11	224	55800548A	647	55900157A	640	56100010	608
53665-87	364	54000166	387	54381-11	224	55800549A	647	55900165	651	56100015	608
53690-06A	85, 249, 356	54001-04A	252	54382-11	326	55800550A	647	55900166	650	56100034	607
53702-04A	738	54014-05	370	54383-11	327	55800551A	647	55914-98	645	56100036	608
53743-97	354	54049-10	124	54384-11	113	55800563	632	55954-00	643	56100048	604
53797-09	119	54051-08A	249	54397-11	228	55800568	648	55967-08	635	56100083	18, 592
53803-06	345	54055-10	124	54530-10	87	55800569	648	55975-08A	634	56100098A	601
53804-06	345	54074-10B	70	54564-09	386	55800579	635	55977-09A	634	56100101A	601
53810-00C	235	54075-10B	117	54628-06	386	55800580	638	55985-10	634	56100108	598
53815-00A	235	54097-10	119	54630-03A	387	55800587	638	55996-09	650	56100112	598
53842-00C	413	54099-10	338	54631-02B	387	55800589	645	56000029	410, 616	56100133	594
53862-00	78, 123, 239	54145-10	374	54635-09	387	55800590	645	56000039	621	56100134	594

56100138	18, 594	56100355	608	56929-10	650	57000389EEL	796	57000482EFP	797	57100257DH	792
56100142	20, 600	56100356	599	56942-10B	641	57000389EEN	796	57000482EFU	797	57100257DWC	792
56100157	588	56100358	606	57000063	321	57000389EEO	796	57000482EKA	797	57100257DZN	792
56100158	590	56165-03	651	57000307	429	57000389EEP	796	57000482EKG	797	57100257DZT	792
56100159	588	56166-08	643	57000387DH	796	57000389EEV	796	57000482EKP	797	57100257DZW	792
56100160	590	56170-83TA	652	57000387DWC	796	57000389EFC	796	57000482ELD	797	57100257ECL	792
56100174	586	56178-92TA	652	57000387DZS	796	57000389EFF	796	57000482ELE	797	57100257ECN	792
56100175	586	56180-08	643	57000387DZW	796	57000389EFH	796	57000482ELG	797	57100257EEL	792
56100199	57, 618	56246-08	602	57000387EEV	796	57000389EFM	796	57000482ELI	797	57100257EEN	792
56100202	20, 618	56246-96A	602	57000387EFC	796	57000389EFP	796	57000510	321	57100257EEO	792
56100218	599	56263-08	602	57000387EFF	796	57000389EFW	796	57000529	311	57100257EEP	792
56100222	19, 590	56263-96A	602	57000387EFH	796	57000389EJL	785	57000536EJL	785	57100257EEV	792
56100223	19, 586	56266-09	651	57000387EFM	796	57000389EKA	796	57001042DH	791	57100257EEZ	792
56100224	19, 588	56267-09	650	57000387EFP	796	57000389EKG	796	57001042EEZ	791	57100257EFC	792
56100231	580	56269-09	650	57000387EKA	796	57000389EKP	796	57001042EFC	791	57100257EFD	792
56100232	580	56275-08	603, 608	57000387ELD	796	57000389EKR	796	57001042EFF	791	57100257EFF	792
56100233	17, 580	56275-96B	603, 608	57000387ELG	796	57000389ELD	796	57001042EFH	791	57100257EFH	792
56100234	581	56298-03A	651	57000387ELI	796	57000389ELE	796	57001042EKG	791	57100257EFM	792
56100235	581	56405-08	600	57000388DH	796	57000389ELG	796	57001042EKP	791	57100257EFP	792
56100236	17, 581	56459-01A	605	57000388DWC	796	57000389ELI	796	57001042ELD	791	57100257EFU	792
56100253	606	56459-08	605	57000388EEN	796	57000394A	313, 712	57001042ELE	791	57100257EFW	792
56100255	607	56486-01	652	57000388EEV	796	57000395A	313, 712	57001042ELG	791	57100257EKA	792
56100256	606	56567-86B	652	57000388EFF	796	57000482DH	797	57001042ELI	791	57100257EKG	792
56100257	607	56623-99A	639	57000388EFH	796	57000482DWC	797	57015-06	110	57100257EKP	792
56100259	607	56626-99	776	57000388EFP	796	57000482DZT	797	57061-09	219	57100257EKR	792
56100260	607	56740-04	596	57000388EKA	796	57000482DZW	797	57070-97DH	64, 111	57100257ELD	792
56100261	607	56740-08	596	57000388ELD	796	57000482ECL	797	57070-98	64, 111	57100257ELE	792
56100264	607	56741-04	596	57000388ELG	796	57000482ECN	797	57100179	271	57100257ELG	792
56100266	607	56746-08	600	57000388ELI	796	57000482EEO	797	57100198	320	57100257ELI	792
56100267	607	56751-04	596	57000389DH	796	57000482EEP	797	57100210	320	57100258	792
56100268	607	56789-05	266	57000389DWC	796	57000482EEZ	797	57100211	93	57100270	320
56100318	606	56799-04	605	57000389DZS	796	57000482EFC	797	57100212	111	57100297	97
56100319	585	56832-04C	640	57000389DZT	796	57000482EFC	797	57100213	259	57109-01	30
56100331	606	56857-05A	635	57000389DZW	796	57000482EFD	797	57100226	97	57140-05	220
56100332	584	56902-08	642	57000389ECL	796	57000482EFF	797	57100227	397	57141-05	220
56100342	606	56916-07	650	57000389ECN	796	57000482EFH	797	57100233	795	57164-10	308

886 PART#/PAGE# REFERENCE

57166-10A	314	57200086EGZ	801	57200087EEV	801	57203-07	319, 777	57300226EFC	792	57400112	219
57185-05	310	57200086EHP	801	57200087EEZ	801	57205-05	35	57300226EFF	792	57400114	219
57199-05	108, 218	57200086EHU	801	57200087EFC	801	57207-05A	776	57300226EFH	792	57400115	219
57200086BDK	801	57200086EHV	801	57200087EFD	801	57211-05	30	57300226EFU	792	57400120	109
57200086BYZ	801	57200086EHY	801	57200087EFF	801	57262-08	63	57300226EFW	792	57400143	222
57200086DH	801	57200086EJA	801	57200087EFH	801	57300-06	107, 167	57300226EHU	792	57400146A	307
57200086DWC	801	57200086EJD	801	57200087EFM	801	57300065	12, 59, 118, 183, 233	57300226EHW	792	57400150	317
57200086DWG	801	57200086EJH	801	57200087EFP	801	57300149	211, 702	57300226EHY	792	57400159	221
57200086DZN	801	57200086EKA	801	57200087EFU	801	57300150	211, 702	57300226EJA	792	57400176	306
57200086DZP	801	57200086EKG	801	57200087EFW	801	57300151	211, 702	57300226EJD	792	57400184	61
57200086DZS	801	57200086EKP	801	57200087EGO	801	57300165	211, 702	57300226EJJ	792	57400192	10
57200086DZW	801	57200086EKR	801	57200087EGS	801	57300185	211, 702	57300226EKA	792	57400204	308
57200086DZY	801	57200086ELD	801	57200087EGV	801	57300186	211, 702	57300226EKG	792	57400205	308
57200086DZZ	801	57200086ELE	801	57200087EGX	801	57300225DH	792	57300226EKP	792	57400206	308
57200086EAI	801	57200086ELG	801	57200087EGZ	801	57300225EEZ	792	57300226EKR	792	57400224	309
57200086ECL	801	57200086ELI	801	57200087EHP	801	57300225EFC	792	57300226ELD	792	57400225	309
57200086ECN	801	57200087BDK	801	57200087EHU	801	57300225EFF	792	57300226ELE	792	57400226	309
57200086EDO	801	57200087BYZ	801	57200087EHV	801	57300225EFH	792	57300226ELG	792	57400227	309
57200086EEL	801	57200087DH	801	57200087EHY	801	57300225EFU	792	57300226ELI	792	57400228	309
57200086EEN	801	57200087DWC	801	57200087EJA	801	57300225EFW	792	57300236	211, 702	57400229	310
57200086EEO	801	57200087DWG	801	57200087EJD	801	57300225EHU	792	57301-06	107, 167, 217	57400243	310
57200086EEP	801	57200087DZN	801	57200087EJH	801	57300225EHW	792	57331-07	107, 217	57400254	313, 617
57200086EEV	801	57200087DZP	801	57200087EKA	801	57300225EHY	792	57338-08	108	57400255	316
57200086EEZ	801	57200087DZS	801	57200087EKG	801	57300225EJA	792	57357-07	306	57400256	316
57200086EFC	801	57200087DZT	801	57200087EKP	801	57300225EJD	792	57400006	64, 827	57400270	314
57200086EFD	801	57200087DZW	801	57200087EKR	801	57300225EJJ	792	57400007	222, 827	57400271	314
57200086EFF	801	57200087DZY	801	57200087ELD	801	57300225EKA	792	57400008	64, 827	57400273A	307
57200086EFH	801	57200087DZZ	801	57200087ELE	801	57300225EKG	792	57400021	218	57400274	307
57200086EFM	801	57200087EAI	801	57200087ELG	801	57300225EKP	792	57400053	63	57400279	315
57200086EFP	801	57200087ECL	801	57200087ELI	801	57300225EKR	792	57400060	30	57400280	315
57200086EFU	801	57200087ECN	801	57200139	59, 101	57300225ELD	792	57400091	308	57400281	315
57200086EFW	801	57200087EDO	801	57200140	59, 101	57300225ELE	792	57400092	308	57400294	316
57200086EGO	801	57200087EEL	801	57200157	321	57300225ELG	792	57400093	314	57400295	316
57200086EGS	801	57200087EEN	801	57200159	59, 101	57300225ELI	792	57400094	314	57400296	316
57200086EGV	801	57200087EEO	801	57200222DH	787	57300226DH	792	57400110	219	57400299	316
57200086EGX	801	57200087EEP	801	57200223DH	787	57300226EEZ	792	57400111	219	57400310	315

57400315	217	57688-10	219	58189-98	319, 776	58652-97A	220	58900196EFP	790	58904-03	318, 777
57400318	62	57716-01	63, 109	58192-87A	63, 110	58653-97A	220	58900196EFU	790	58907-96B	217, 218
57400319	62	57740-05	311	58195-94	305	58657-97A	222	58900196EFW	790	58932-98	317
57400320	316	57754-04	222	58204-98	310	58683-89B	320	58900196EGZ	790	59002-98	278, 400
57400323	167	57799-00	145, 233	58207-04	310	58684-89B	320	58900196EJD	790	59005-98	401
57400324	169	57800-00	429	58221-04	305	58703-09	62, 108	58900196EKA	790	59027-99	279
57400325	170	57801-11	62	58240-95	219	58706-09	62, 108	58900196EKG	790	59045-00B	398
57400326	168	57802-11	62	58243-95	219	58714-06	320	58900196EKP	790	59052-98	278, 400
57400327	168	57804-07	311	58275-95	219	58742-05	218, 737	58900196EKR	790	59071-98	279
57400328	170	57805-03A	373	58277-95	222	58770-96	218	58900319	791	59081-96	278, 400
57400329	171	57838-08	61, 107	58278-95	219	58772-97	221	58900336BYM	791	59133-99	312
57400330	169	57850-01	33	58283-04B	315	58865-03	109, 218	58900336DH	791	59141-98	748
57400331	168	57892-11	373	58298-87	776	58882-04BDK	59	58900336ECN	791	59147-96	277, 401
57400332	170	57957-98A	315	58301-96	309	58882-04DH	59	58900336EEO	791	59209-91T	278, 399
57400333	168	57965-97A	110, 217	58302-96	309	58900-11	318	58900336EEP	791	59213-96	313
57400334	167	57975-99	222	58303-96	309	58900085A	398	58900336EEZ	791	59228-91	277, 401
57400335	170	57981-97	305	58308-95	319, 776	58900196BEO	790	58900336EFC	791	59336-09	746
57400336	168	57995-96	305	58314-97	309	58900196BYM	790	58900336EFD	791	59338-09	746
57400337	168	58002-09A	321	58325-06	305	58900196DH	790	58900336EFF	791	59367-97	278
57400345	63	58022-07A	321	58346-06	108, 168	58900196DWC	790	58900336EFH	791	59369-97	278
57400360	171	58024-96A	63	58348-06	108, 168	58900196DZN	790	58900336EFU	791	59380-05	746
57400361	168	58042-08BDK	111	58350-96	110, 217	58900196DZS	790	58900336EKG	791	59397-03DH	398
57400367	169	58042-08DH	111	58361-03	109, 217, 720	58900196DZT	790	58900336EKP	791	59473-09	142
57400368	169	58053-10	62	58387-06	108, 168, 218	58900196DZW	790	58900360EGW	790	59500105BEO	395
57400369	170	58063-04	62, 108	58397-00	217	58900196ECL	790	58900360EGY	790	59500245	395
57400380	305	58073-09	218	58402-04	776	58900196ECN	790	58900360EJB	790	59500246	395
57400381	305	58120-96A	311	58433-96	305	58900196EEL	790	58900360EJC	790	59500560BYM	55, 802
57400383	305	58135-94	305	58444-06	108, 168, 218	58900196EEO	790	58900363EEM	790	59500560DH	55, 802
57454-10	592	58146-07	320	58519-07A	317	58900196EEP	790	58900400ELF	791	59500560EEL	55, 802
57457-10	592	58156-08A	311	58520-79TC	390	58900196EEV	790	58900400ELH	791	59500560EEO	55, 802
57466-10	36	58158-08	62, 110	58568-98A	311	58900196EEZ	790	58900403ELF	790	59500560EEP	55, 802
57474-11	646	58163-02	306	58602-04	62, 108	58900196EFC	790	58900403ELH	790	59500560EEZ	55, 802
57485-11	646	58164-96A	63, 110	58617-09	108	58900196EFD	790	58900421ELD	790	59500560EFC	55, 802
57609-08	108	58165-09	218	58630-09	108	58900196EFF	790	58900421ELE	790	59500560EFD	55, 802
57610-09	30	58187-86	309	58649-97A	220	58900196EFH	790	58900423ELD	791	59500560EFF	55, 802
57682-10	62	58187-96	309	58651-97A	220	58900196EFM	790	58900423ELE	791	59500560EFH	55, 802

888 PART#/PAGE# REFERENCE

59500560EFW	55, 802	60543-99B	551	61100107	103, 211, 702	61300461DZW	789	61300657	541	61300788	448, 562
59500560EKG	55, 802	60553-07A	551	61100117	211, 703	61300461ECL	789	61300658	545	61300792	545
59500560EKI	55, 802	60572-86	546, 554	61100125	211, 703	61300461ECN	789	61300671BEO	793	61300794	413
59500560EKN	55, 802	60654-07A	271	61100126	702	61300461EEL	789	61300671BYM	793	61300811	205
59500560ELE	55, 802	60655-07A	271	61100127	211, 702	61300461EEN	789	61300671DH	793	61300817	205
59500560ELM	55	60665-99B	551	61100128	702	61300461EEO	789	61300671DWC	793	61300828	449, 563
5950056ELM	802	60668-99	546	61100129	211, 703	61300461EEP	789	61300671DZN	793	61300835	26
59500644	55, 802	60670-85A	546, 554	61200008A	696	61300461EEV	789	61300671DZS	793	61300845	447
59500689EGB	55, 802	60706-09A	553	61286-92T	413	61300461EFC	789	61300671DZT	793	61300846	447
59500689EGL	55, 802	60713-07	546, 553	61300049A	413	61300461EFF	789	61300671DZW	793	61300875	396
59500786ELF	55, 802	60713-99	546, 553	61300055	540	61300461EFH	789	61300671ECL	793	61300891	448, 562
59500786ELH	55, 802	60715-99B	553	61300057	447, 540	61300461EFM	789	61300671ECN	793	61300892	448, 562
59582-02A	277, 401	60717-07A	553	61300109	470	61300461EFP	789	61300671EEL	793	61300923EJB	793
59600018	418	60739-07	554	61300110	470	61300461EFW	789	61300671EEO	793	61300923EJC	793
59600022	399	60758-06A	553	61300120	449, 564	61300461EKA	789	61300671EEP	793	61300923EJE	793
59651-01	278, 400	60764-06A	551	61300128	449, 564	61300461EKG	789	61300671EEV	793	61300923EJF	793
59664-03	145, 277	60766-06	546	61300186	143	61300461EKP	789	61300671EEZ	793	61300923EJG	793
59685-10	423, 743	60782-06A	551	61300217	542	61300461EKR	789	61300671EFC	793	61300923ELF	793
59776-10	423, 743	60800005	134	61300218	541	61300461ELD	789	61300671EFD	793	61300923ELH	793
59802-05	108, 218	60815-08A	554	61300220	544	61300461ELE	789	61300671EFF	793	61300928	536
59863-94T	748	60826-11	541	61300224	540	61300461ELG	789	61300671EFH	793	61300929	536
60051-01	748	60867-08	271	61300227	23	61300461ELI	789	61300671EFM	793	61300960EEM	793
60065-03	748	60868-10	555	61300228	21	61300505	789	61300671EFP	793	61300991	537
60193-07	747	60876-11A	550	61300254	545	61300516	471, 563	61300671EFU	793	61301022	537
60210-07	747	60885-10	555	61300275	312	61300517	471, 563	61300671EFW	793	61301098ELD	793
60215-06	746	60886-11A	550	61300299	475	61300520	22	61300671EJD	793	61301098ELE	793
60277-07	747	60938-10	142	61300310	313	61300536	563	61300671EKA	793	61308-09A	413
60280-07	747	60947-10	103	61300358	312	61300542	539	61300671EKG	793	61335-09A	413
60293-00	140	60972-10	103	61300364A	26	61300585	21	61300671EKP	793	61374-04	413
60300004	271	60978-10	142	61300420	266, 729	61300586	21	61300671EKR	793	61400001	411
60316-00A	271	61100006A	701	61300421	266, 729	61300621	750	61300688	443	61400002	555
60379-09A	97	61100007A	701	61300452	750	61300622	750	61300762	445	61400025	544
60402-04A	97	61100076	211, 702	61300461DH	789	61300623	750	61300768	444, 535	61400028	321
60408-09	417	61100093	211, 702	61300461DWC	789	61300654	542	61300769	444, 533	61400058	365
60514-07A	140	61100103	211, 703	61300461DZS	789	61300655	540	61300770	444, 534	61400074	780
60529-90A	546, 554	61100106	103, 211, 702	61300461DZT	789	61300656	544	61300787	448, 562	61400148	567

61400149	728	61400348	725	61400412ELE	789	61775-59T	804	62600030	833	62809-06	566
61400176	567	61400349	725	61400412ELL	789	61776-61T	804	62600031	833	62811-08C	701
61400193	405	61400353	208, 725	61400429	208, 725	61777-63T	804	62600033	838	62818-06F	701
61400194	405	61400354	208, 725	61400430	208, 725	61782-91T	804	62600038	833	62823-06C	701
61400197	405	61400355	208, 725	61400431	208, 725	61783-92T	804	62600041	833	62823-08C	701
61400199	402	61400359	406	61400432	208, 725	61784-92T	804	62600042	833	62858-99	566
61400201	402	61400360	406	61400433	208, 725	61785-92T	804	62600043	833	62896-00B	565
61400205	781	61400361	406	61400434	208, 725	61814-55T	804	62600059	833	62910-06C	701
61400206	780	61400374	781	61400435	209, 406, 700	61840-94T	804	62600060	833	62910-09C	701
61400210	405	61400375	781	61400436	209, 406, 700	61929-98	72	62600082	835	62920-00A	411
61400224	312	61400377	781	61400437	209, 406, 700	62027-04	72	62600083	835	62946-09A	565
61400225	394	61400379	21	61400438	209, 406, 700	62028-04	145	62600084	835	62955-09A	565
61400255	728	61400399	409	61400439	209, 406, 700	62030-04	72	62600085	835	62962-01A	39
61400260	408	61400411	789	61400440	209, 406, 700	62063-01	373	62600087	835	62965-01	276
61400269	25	61400412BYM	789	61400451	402	62378-10A	413	62600088	835	62974-09A	565
61400292	729	61400412DH	789	61400455	544	62500026	205	62600089	835	63002-09A	565
61400293	729	61400412EEO	789	61400509	205	62500027	205	62600090	835	63004-09A	565
61400294	729	61400412EEP	789	61400517	98, 213	62600004	838	62667-87TA	101, 565	63020-04	566
61400295	729	61400412EEZ	789	61400573	208, 728	62600005	833	62668-87TA	565	63023-05	101, 565
61400296	404	61400412EFC	789	61400574	208, 728	62600007	833	62692-07	566	63026-05	651
61400297	404	61400412EFD	789	61400593	312	62600008	833	62693-07A	566	63030-09A	565
61400298	404	61400412EFF	789	61400598	530	62600009	833	62700005A	565	63055-09A	565
61400299	404	61400412EFH	789	61400599	530	62600010	838	62700009	101, 565	63065-09A	565
61400311	401	61400412EFM	789	61400602	530	62600011	833	62700011	101, 565	63121-11A	394
61400312	401	61400412EFP	789	61400603	530	62600013	833	62700015	836	63131-09A	565
61400317	408	61400412EFU	789	61400606	530	62600014	833	62700017A	144	63133-10A	103, 701
61400319	728	61400412EGS	789	61400607	530	62600015	833	62700045	834	63134-10A	103, 701
61400323	447, 539	61400412EGX	789	61400609	530	62600017	833	62700055	834	63139-10A	103, 701
61400325	313	61400412EGZ	789	61653-04	102	62600018	833	62700082	100	63140-10A	103, 701
61400328	409	61400412EHV	789	61740-90T	804	62600019	838	62700180	565	63692-00A	566
61400334	409	61400412EHY	789	61741-93T	804	62600021	833	62700192	566	63698-02	566
61400335	567	61400412EJH	789	61742-93T	804	62600023	833	62700194	565	63731-99A	834
61400339	447, 538	61400412EKA	789	61769-40T	804	62600024	833	62700199	836	63793-01K	834
61400344	98, 213	61400412EKG	789	61769-47T	804	62600025	838	62700204	323	63794-10	836
61400346	213, 273	61400412EKP	789	61771-66TB	804	62600026	838	62700239	836	63795-10	835
61400347	725	61400412ELD	789	61774-51T	804	62600027	838	62778-10	211	63796-77A	834

890 PART#/PAGE# REFERENCE

63797-10	836	64900638	450	65100096	457	65400480	455	66441-05	267	67700487	714, 728
63798-99A	834	64900640	452	65100097	457	65400481	455	66443-06	143	67704-03	35, 724
63799-10	836	64900641	452	65100107	502	65600155	502	66462-07	143	67734-88T	730
63805-80A	834	64900642	452	65100122	452	65948-00B	843	66477-10	556	67735-91T	730
63806-00Y	834	64900643	452	65100123	452	65958-04B	843	66543-08	556	67737-88T	730
63810-80A	834	64900683	27	65100153	450	65989-90B	843	66718-01	102, 144	67738-91T	730
63813-90	834	64900690	450	65100160	453	65989-97D	843	67074-02	719	67750-88T	730
64216-09	251	64900691	450	65100161	453	65991-82B	843	67182-07	697	67751-91T	730
64227-08	251	64900749	454	65100162	453	66000004	840	67313-05A	697	67752-77T	730
64230-08	251	64900752	453	65100163	453	99814-09	840	67315-05A	697	67761-96	730
64800043	481	64900754	453	65100164	453	99816-09	840	67516-04B	698	67774-10	423, 743
64800044	481	64900756	453	65100165	453	99819-09	840	67516-08	698	67783-78T	730
64800059	458	64900758	453	65100166	453	99820-09	840	67522-04B	698	67791-91T	730
64800062	458	64900760	454	65247-09	477	66000005	842	67700059	715	67796-91T	730
64806-07A	479, 503	64924-09	503	65271-03	39	66000033	841	67700093B	715	67800055A	734
64900137	477	64937-00A	251	65400064	483	66000034	841	67700109	716	67800056A	734
64900186B	459, 480	64938-00	251	65400078	479, 503	66000038	840	67700112	716	67800060	734
64900187B	459, 480	64981-09	483	65400088	477	66000041	841	67700115	728	67800061	734
64900208A	501	65100015	459, 482	65400117	483	66000042	841	67700116	728	67800065	243
64900209A	501	65100016	459, 482	65400137A	503	66000043	841	67700117	728	67800071	82
64900220	27	65100017	459, 482	65400143	503	66000044	841	67700144A	10, 715	67800133	745
64900242	477	65100018	459, 482	65400167	27	66000046	841	67700145A	10, 715	67800134	745
64900243	477	65100019	459, 482	65400172	477	66000107	828	67700215	726	67800166	723
64900334	478	65100028	459, 482	65400285	456	66000130	842	67700216	727	67800167	732
64900335	478	65100044	479, 502	65400404	503	66000147	842	67700260	716	67800241A	421, 742
64900340	478	65100048A	479, 502	65400405	479, 502	66006-29F	843	67700261	716	67800242A	421, 742
64900341	478	65100049	479, 502	65400422	503	66007-84	843	67700353	717	67800355	744
64900342	478	65100054	482	65400457	451	66010-82B	843	67700354	717	67800356	744
64900343	478	65100056	26	65400458	451	66010-97D	843	67700355	717	67800357	744
64900476	501	65100062	459, 482	65400459	451	66261-04	102	67700356	717	67800358	744
64900477	501	65100063	479, 502	65400460	451	66262-04	102	67700426	714	67800366A	723
64900552A	456	65100076	457	65400461	451	66368-97	144	67700427	714	67800367	723
64900553A	456	65100078	457	65400464	479, 502	66375-06	143	67700430	714	67800368	419
64900554A	456	65100084	457	65400466	453	66375-97	144	67700433	714	67800374	736
64900555A	456	65100085	457	65400468	453	66426-04	143	67700439	717	67800375	736
64900636	450	65100095	457	65400472	455	66439-07	143	67700455	717	67800448A	421, 742

67800449A	421, 742
67800450A	421, 742
67800451A	421, 742
67800452	64, 737
67800457	745
67800459	745
67800477	734
67800478	734
67800479	734
67800480	734
67800483	422, 740
67800484	422, 740
67800491	422, 740
67800492	422, 740
67800493	422, 740
67800494	422, 740
67800554	423, 743
67800555	423, 743
67800557	64, 737
67800574	423, 743
67800575	423, 743
67800589	420, 741
67800604	421, 742
67800605	421, 742
67800606	421, 742
67800607	421, 742
67800608	421, 742
67800609	421, 742
67800614	744
67800615	744
67800616	744
67800617	744
67800639	733
67800640	733
67800642	733
67800643	733

67800644	733
67800645	733
67800706	396, 732
67800707	396, 732
67800802	192
67800830	192
67800977	735
67800978	735
67800980	735
67800981	735
67800982	735
67890-91C	267
67891-99	267
67900007	746
67900008	424, 747
67900056	424, 747
67900058	424, 747
67900127A	243
67900130	125
67900273	424, 747
67900275	424, 747
67900359	55, 802
67900360	55, 802
67931-11	419
67932-11	419
68000005	239
68000026	721
68000029A	423, 743
68000035	712
68000042	723
68000043	723
68000051	721
68000069	721
68000076	78, 123, 238, 347
68000077	78, 123, 238, 347

68000082	420, 741
68000083	420, 741
68000090	718
68000092	718
68000104	712
68000105	744
68000110	720
68000111	351, 352
68000112	363
68000113	363
68000114	365
68000115	365
68000116	351, 352
68000119A	423, 743
68000123A	739
68000128	418
68000129	418
68000141	718
68000142	718
68000151	424
68000152	424
68000170	718
68000171	718
68000183	719
68000184	719
68000190	712
68000191	712
68000194	711
68000213	710
68000214	710
68000218	709
68000231	711
68000232	711
68000233	711
68000252	717
68000253	717

68006-83T	746
68011-88T	746
68011-91T	746
68055-10BHP	266
68065-10	351, 352
68116-08	745
68117-08	745
68118-08	745
68127-10	736
68128-10	736
68129-97	64, 111
68129-98DH	64, 111
68160-99	420
68185-00	737
68189-07A	750
68192-99	420
68200-00D	829
68200-07A	829
68207-00D	829
68207-07A	829
68208-98A	722
68211-05	35
68219-10	351, 352
68227-09	119, 125
68250-08A	363
68266-03	737
68271-08A	363
68286-10	365
68311-01	746
68317-06A	829
68328-06A	829
68332-08	746
68348-05	722
68352-06B	829
68358-07A	423, 743
68388-10	365

68411-10	736
68412-99A	721
68413-99A	721
68435-10	736
68517-94A	64, 737
68544-10	125
68564-06	737
68593-06	724
68595-06	724
68603-01	109, 720
68605-08A	720
68611-98	738
68615-04	738
68617-04	738
68643-09	64, 737
68669-05A	722
68670-05A	722
68718-02	125
68732-02A	125
68733-02A	125
68775-93TA	730
68926-00	828
68926-07	828
68927-00	828
68971-98B	111
69000007	102, 749
69000009	102, 749
69000038	820
69000058	134
69015-08	276
69036-88A	751
69039-09A	750
69060-90H	102, 749
69063-03A	736
69112-95E	102, 751
69153-03A	736

69166-01B	751
69167-02B	751
69200033	682
69200042A	739
69200091	425, 694
69200106	682
69200181	362
69200357	426, 694
69200441	722
69200442	722
69200605	426
69200722	428, 695
69200765A	739
69200772	347
69200826	425, 694
69200854	426, 694
69200855	426, 694
69200863	718
69200864	718
69200865	672
69200907	672
69200970	426, 694
69200971	426, 694
69201099	425, 694
69201108	718
69201109	718
69201136	425, 694
69201146	695
69201148	694
69201149	695
69201150	695
69201525	710
69201529	710
69201530	710
69201594	710
69201595	710

892 PART#/PAGE# REFERENCE

69201599A	428, 695	69627-99	726	70248-02B	629	71031-04	830	73294-10	266	74775-11B	696
69201625	710	69732-05	727	70255-02B	629	71040-04	830	73342-09	731	74776-11C	696
69201636	710	69733-05	727	70264-94A	428, 695	71282-04	145	73343-09	731	74777-11B	696
69201704	437	69734-05	727	70270-04A	428, 695	71283-01	250	73344-09	731	75008-02A	851
69201706	428, 695	69735-05	727	70641-08	347	71400105	428	73369-10	241	75012-82D	699
69201726	684	69736-02	731	70683-08	78	71400106	428	73415-11	123, 238, 239	75014-06C	701
69201750	695	69738-05	727	70900070B	696	71400126A	409	73416-11	744	75027-08C	701
69208-09	734	69739-01	731	70900071A	696	71400129	428	73420-11	744	75031-09	100
69227-04A	723	69740-01	726	70900072A	696	71500110	625	74538-09	398	75041-03	705
69228-04	723	69749-05	727	70900078	697	71500177	625	74541-00	403, 700	75042-03	705
69230-04	723	69752-04	731	70900100C	100, 696	71500178	625	74543-00	398	75098-08A	704
69234-04	723	69753-04	731	70900171B	696	71500179	625	74550-92T	403	75102-04	705
69235-04	723	69756-05	731	70900176	698, 699	71500180	625	74552-04A	698	75104-04	705
69284-05	720	69757-05	731	70900274	100, 696	71500185	624	74553-04A	698	75108-06	705
69287-07	721	69758-05	731	70900283	699	71500186	625	74554-04	698	75110-98B	851
69303-02	734	69759-05	731	70900284	699	71500187A	625	74562-98	403	75113-04A	698
69304-02	734	69760-05	731	70900354	704	71500228A	625	74567-11	276	75113-08	698
69307-02	736	69761-05	731	70900463	412	71500248C	628	74584-99	405	75115-06	705
69308-02	736	69793-07	730	70900465A	412	71500250B	628	74597-01	276	75133-99	699
69309-10	829	69795-07	730	70900474A	412	71500285	625	74604-99	405	75137-98B	851
69366-07	745	69797-08	724	70900501	412	71500286	625	74610-08	276	75138-09	699
69367-07	745	69802-08	724	70900521	704	71500411	625	74612-06	403	75158-10	851
69368-11	78	69817-07A	745	70900660	57	71500412	625	74616-04	144, 276	75237-03C	704
69433-08A	737	69818-06	723	70900661	57	71500441	625	74622-04	427	75242-08A	704
69461-06D	739	69820-06	738	70900709	704	71500442	624	74622-06	427	75327-09C	701
69462-06D	739	69857-07	241	70900773	698	71500515	625	74622-09	427	75357-10A	704
69463-06B	739	69929-07	241	70900774	698	71500517	625	74661-04	411, 700	75358-10A	704
69492-05	732	70032-09	362	70900775	698	71718-02	629	74667-06	144	76000013	680
69494-06	419	70113-08	362	70900777	698	71790-05	411	74682-10	698	76000021	680
69577-06A	732	70169-06A	682	70900778	698	71802-03	625	74683-10	698	76000024A	693
69604-03A	728	70172-06	682	70900781	704	71804-03	37, 625	74688-10	698	76000050	680
69611-06	724	70213-02C	629	70900816	209	71813-09	624	74689-10	698	76000051	677
69622-99B	726	70222-96B	37, 624	70900817	209	71816-09	625	74690-10	698	76000068	676
69623-99A	726	70223-96B	624	70900821	412	71826-11	624	74691-10	698	76000070	676
69624-99A	726	70228-96C	624	70900835	209	72673-11	695	74692-10	698	76000074	677
69626-99	726	70239-07	629	70900836	209	73279-10	82	74774-11C	696	76000143	681

76000156	405
76000157	405
76000169	676
76000191B	693
76000192B	693
76000193	14, 251, 693, 779
76000202	679
76000238	681
76000256	678
76000257	678
76000259	687
76000263	676
76000275	679
76000277B	666
76000278	659, 666
76000280	659
76000307	408
76000308	362, 689
76000317A	661
76000318A	662
76000319A	668
76000351	672
76000353A	669
76000390	682
76000410A	660
76000411A	660
76000486A	672
76000487A	662
76000489A	661
76000497BYM	795
76000497DH	795
76000497DWC	795
76000497DZN	795
76000497DZS	795
76000497DZT	795
76000497DZW	795

76000497EAI	795
76000497ECL	795
76000497ECN	795
76000497EEL	795
76000497EEN	795
76000497EEO	795
76000497EEP	795
76000497EEV	795
76000497EEZ	795
76000497EFC	795
76000497EFD	795
76000497EFF	795
76000497EFH	795
76000497EFM	795
76000497EFP	795
76000497EFU	795
76000497EFW	795
76000497EKA	795
76000497EKG	795
76000497EKP	795
76000497EKR	795
76000497ELD	795
76000497ELE	795
76000497ELG	795
76000497ELI	795
76000505	663
76000511	671
76000512	671
76000522	408
76000523	659, 666
76000524A	667
76000526A	669
76000537	690
76000539	317
76000548A	661
76000549	690

76000573	692
76000574	692
76000576	690
76000582	689
76000584	670
76000585	670
76000586	670
76000587A	660
76000594A	667
76000605	690
76000617	663, 670
76000618	670
76000621	408
76000623	408
76000635	691
76000636	691
76000660	662, 668
76000666	691
76000670	690
76000671A	660
76000676	407
76000677	407
76000678	407
76000685	407
76000686	407
76000687	407
76000691	407
76000692	407
76000693	407
76000700	691
76000730	687
76000734	668
76000735	404
76000736A	685
76000740A	685
76000745	670

76000746	670
76000747	663, 670
76000748	659
76000749	670
76000751	670
76000758	14, 690
76000768	684
76000829	671
76000834	671
76000835	686
76000842	672
76000862	688
76000863	688
76208-07	689
76251-98A	688
76312-98	687
76386-08	688
76386-09A	688
76388-08A	688
76400-09	688
76404-06	681
76410-09	688
76476-10	681
76556-09	689
76561-09	689
76572-09	686
77028-10	678
77037-10	678
77117-10	687
77143-07	403
77173-08	682
77181-10	678
77196-08	629
79175-10DH	356
79179-08	363
79192-10	356, 357

79211-08A	414
80503-07	501
8060	572
80601-09A	476
8061	572
80611-09	459, 482
8062	572
8063	572
8064	572
8065	572
8066	572
8067	572
80674-08A	476
80678-08	476
8071	572
80716-08	482
8072	572
80726-09A	501
8073	572
8074	572
80794-10A	476
80812-10	482
80817-10A	479
80818-10	479
80821-10	477
80829-10A	479
80847-10	483
80872-12	477
83812-09	418
83819-09	388
83825-09B	418
83841-09	418
83843-09	418
83911-09B	849
83946-11	424
83968-10	373

83976-10	373
83989-10A	429
84023-11	418
84031-11	370
88232-06	370
88237-07	241
88238-07	241
88272-06	779
88286-07	245
88299-09	365
88306-07A	242
88373-10A	246
88390-10	82
90133-06B	245
90181-08A	125
90200389	243
90200390	243
90200421	416
90200561	364
90200570	127
90200612	679
90200613	679
90200614DH	679
90200615DH	679
90200616A	241
90200641A	246
90200669	246
90200670	246
90200678	243
90200735	420
90200736	420
90200737	365
90200787	366
90200788	366
90200791	367
90200792	365

894 PART#/PAGE# REFERENCE

90200793	365	90200826EKG	795	90200827EGM	795	90200906	14	90201093DZU	794	90201561A	192
90200816	242	90200826EKP	795	90200827EGO	795	90200914	416	90201093EAE	794	90201567	195, 247
90200826BYM	795	90200826EKR	795	90200827EGS	795	90200915	416	90201093EAG	794	90201568	195, 247
90200826BYZ	795	90200826ELD	795	90200827EHU	795	90200918	368	90201093EEM	794	90201644A	193
90200826DAA	795	90200826ELE	795	90200827EKA	795	90200981	366	90201093EGA	794	90201645A	193
90200826DGH	795	90200826ELG	795	90200827EKG	795	90200991	371, 775	90201093EGC	794	90201768	247
90200826DWC	795	90200826ELI	795	90200827EKP	795	90200992	373	90201093EGE	794	90201769	81, 84, 194, 248
90200826DWE	795	90200827BYM	795	90200827EKR	795	90201044	134	90201093EGG	794	90201770	81, 84, 194, 248
90200826DXM	795	90200827BYZ	795	90200827ELD	795	90201052	416	90201107	794	90201777	194
90200826DZN	795	90200827DAA	795	90200827ELE	795	90201078BYM	794	90201108	795	90201905EHT	794
90200826DZP	795	90200827DH	795	90200827ELG	795	90201078DH	794	90201109	795	90201905EHX	794
90200826DZS	795	90200827DWC	795	90200827ELI	795	90201078DWC	794	90201206	417	90201905EHZ	794
90200826DZT	795	90200827DWE	795	90200872DH	800	90201078DWG	794	90201306	80, 83	90201906EHT	795
90200826DZW	795	90200827DXM	795	90200872DZN	800	90201078DZN	794	90201312	203	90201906EHX	795
90200826DZZ	795	90200827DZN	795	90200872DZW	800	90201078DZS	794	90201315	203	90201907EHT	795
90200826ECL	795	90200827DZP	795	90200872ECL	800	90201078DZT	794	90201321	81, 83	90201907EHX	795
90200826ECN	795	90200827DZS	795	90200872ECN	800	90201078DZW	794	90201324	85	90201953ELD	794
90200826EEL	795	90200827DZT	795	90200872EEN	800	90201078EAI	794	90201325	81, 84	90201953ELE	794
90200826EEN	795	90200827DZW	795	90200872EEO	800	90201078ECN	794	90201326A	85	90238-00	260
90200826EEO	795	90200827DZZ	795	90200872EEV	800	90201078EEO	794	90201328	80, 82	90300003	127, 243, 827
90200826EEP	795	90200827ECL	795	90200872EEZ	800	90201078EEP	794	90201329	80, 83	90300010	246
90200826EEV	795	90200827ECN	795	90200872EFC	800	90201078EEV	794	90201385DZZ	794	90300017	127, 243, 827
90200826EEZ	795	90200827EEL	795	90200872EFF	800	90201078EEZ	794	90201389	242	90300086	77, 121, 240, 345, 827
90200826EFC	795	90200827EEN	795	90200872EFH	800	90201078EFC	794	90201397DWG	795	90300087	77, 121, 240, 345, 827
90200826EFD	795	90200827EEO	795	90200872EFM	800	90201078EFD	794	90201397EAI	795	90300096	413
90200826EFF	795	90200827EEP	795	90200872EFP	800	90201078EFH	794	90201397ECN	795	90300111	828
90200826EFH	795	90200827EEV	795	90200872EFU	800	90201078EFM	794	90201401DWG	795	90300117	828
90200826EFM	795	90200827EEZ	795	90200872EKA	800	90201078EFP	794	90201401EAI	795	90300118	830
90200826EFP	795	90200827EFC	795	90200872EKP	800	90201078EKA	794	90201401ECN	795	90320-00D	244
90200826EFU	795	90200827EFD	795	90200872EKR	800	90201078EKR	794	90201424	82	90330-08	81, 84
90200826EFW	795	90200827EFF	795	90200872ELD	800	90201084	416	90201433	85	90369-06D	126
90200826EGM	795	90200827EFH	795	90200872ELG	800	90201088DZO	794	90201504ECL	794	90465-98A	73
90200826EGO	795	90200827EFM	795	90200872ELI	800	90201088EAK	794	90201513A	193	90564-06D	126
90200826EGS	795	90200827EFP	795	90200873	800	90201088EAM	794	90201552A	192	90645-03A	416
90200826EHU	795	90200827EFU	795	90200876	365	90201093BHY	794	90201555A	193	90799-94D	85
90200826EKA	795	90200827EFW	795	90200882	370	90201093DZR	794	90201558	194		

90853-06DH	416
90857-06DH	416
90876-05	244
90881-09A	366
90892-09	364
91008-82C	81, 85, 127, 248
91017-10A	127
91051-94	250, 777
91080-93	279
91085-83D	399
91099-94A	399
91100-09	399
91117-97	277, 400
91124-03A	627
91134-01	250
91135-09	145, 250
91194-04	145, 277
91195-04	277, 400
91216-97	364
91274-04	627
91315-04	620
91347-00	764
91402-00	279
91537-00C	245
91558-01B	821
91561-01B	821
91562-01	821
91573-09A	384
91583-99	341
91600001	839
91615-09A	126
91660-06	831
91668-05	341
91671-10	425, 694
91672-07	831
91684-08A	829

91697-06A	620
91716-02	805
91718-02	805
91722-04	779
91723-02	805
91743-87T	250, 777
91744-87T	250, 777
91745-02	805
91772-85A	250, 777
91773-85	777
91790-84C	248
91800029	767
91800030	267
91800066	565
91811-85	805
91815-85	805
91838-92	251
91840-03B	621
91843-97	425, 694
91845-03B	621
91846-03B	621
91848-03B	621
91857-91	779
91864-90T	621
91866-90T	621
91877-97	779
91885-97A	371, 775
91887-98	371, 775
91907-87	621
91909-03B	621
91910-03B	621
91930-92T	621
91931-92T	621
91945-98B	410, 616
91959-97	127, 243, 775
91968-98	620

91971-98	620
91982-03B	621
91983-03B	621
92022-03A	621
92023-03A	621
92059-07A	619
92068-08A	619
92189-06	368
92190-06	620
92200073EDF	799
92200073EDG	799
92200073EDH	799
92200073EDN	799
92200074EDF	799
92200074EDG	799
92200074EDH	799
92200074EDN	799
92200191EJM	787
92200192EJN	786
92200193EJK	784
92200194EJK	784
92200195EJK	784
92200196EJK	784
92200197EJK	784
92200198EJK	784
92200199EJK	784
92200200EJK	784
92200201EJK	784
92200202EJK	785
92200204EJM	787
92200215EJN	786
92200216EJK	784
92200217EJK	785
92238-09	693
92416-08	620
92423-08A	620

92441-10	620
92500011	494
92500019	494
92500025	520
92500026	520
92500027	520
92500028	488
92500031	493
92500032	493
92500033	493
92500035	489
92500038	492
92500041	506
92500042	506
92500047	460
92500054	495
92500055	495
92500056	463
92500057	463
92500058	460
92500059	532
92500060	464
92500062	464
92500064	464
92500070	463
92500071	463
92500072	463
92500073	464
92500074	460
92500075	460
92500076	464
92500088	464
92600-10	410, 617
92900001	823
92900002	823
92900004	823

92900014	15
92900042	823
92900043	823
93024-88	779
93025-88	779
93036-95	779
93037-09	779
93100005	822
93100015	822
93100016	822
93100017	824
93100018	818, 819
93100019	818, 819
93100020	818, 819
93100021	818, 819
93100022	818, 819
93100023	818, 819
93100024	818, 819
93100025	818, 819
93100026	818, 819
93100027	818, 819
93100028	820
93100034	820
93100040	818, 819
93100041	818, 819
93100042	818, 819
93100043	818, 819
93300001	369
93300003	771
93300004	771
93300005	772
93300006	773
93300007	774
93300008	772
93300009	773
93300010	774

93300014	774
93300015	774
93300017	772
93300044	85
93300054B	318
93300060	372
93300061	372
93300062	372
93300063	372
93300069A	773
93300070	371, 775
93300072	371, 775
93300097	319
93300098	339
93300099	774
93300101	774
93300107	196, 775
93300110	196, 775
93300112	776
93300113	776
93300114	776
93500006	267, 397
93500011	397
93511-10	831
93600001	811
93600002	812
93600005	838
93600007	816
93600010	811
93600011	810
93600012	810
93600013	810
93600016	814
93600022	810
93600023	810
93600024	811

896 PART#/PAGE# REFERENCE

93600025	812	93600115	812	94139-01	613	94651-09	816	94924-09	568	99650-02	839
93600026	812	93600116	811	94140-02	615	94663-02	815	94943-07	568	99661-92T	139, 391
93600028	813	93936	803	94204-03A	33	94668-00	845	94968-09	839	99663-92T	139, 391
93600029	810	94001-03	39	94206-03	33, 779	94669-00	844	95615-04	767	99669-04	705
93600031	811	94002-03	39	94207-04	569	94675-99	823	95982-98B	820	99670-04	705
93600032	811	94014-03	39	94208-04	569	94684-00A	845	96396-09	403	99688-10	705
93600033	813	94052-03A	570	94263-04	33	94686-00	837	97008-07	778	99821-09	842
93600034	813	94053-03A	570	94280-04	570	94695-08	844	97026-09	341	99822-02	838
93600056	816	94054-03	570	94281-04	570	94697-08	844	97031-09	230	99825-02	803
93600057A	816	94055-03	570	94289-94T	233	94704-10	824	97400-10	810	99828-09	842
93600062	812	94056-03	570	94291-04A	570	94705-10	824	97401-10	812	99829-09	841
93600063	813	94058-03	570	94413-04	652	94706-10	824	97410-10	837	99847-09	841
93600064	811	94059-03	570	94415-05	138, 262	94708-98	99, 142, 767	98169-88T	778	99855-89	839
93600067	813	94068-03	570	94435-10	844	94753-99	411	98170-88T	778	99856-92	839
93600068	812	94109-95	749	94448-82B	844	94755-99	411	98185-90T	778	99857-97A	839
93600069	811	94111-95	222, 572	94451-05	652	94760-99	814	98187-90T	824	99885-10	838
93600071	810	94112-04	33	94452-05	652	94773-00A	142, 767	98196-85T	778		
93600073	812	94114-02	748	94453-05	652	94773-07	142, 767	98197-85T	778		
93600074	812	94115-93T	572	94454-05	652	94778-10	816	98198-85T	778		
93600075	810	94116-93T	572	94527-95	569	94791-01	815	98199-85T	778		
93600076	811	94117-93T	572	94529-95	569	94793-01	844	98600BF	803		
93600077	810	94118-93T	572	94531-95	569	94811-10	814	98600BY	803		
93600078	811	94119-93T	572	94546-05	748	94819-02	845	98600EK	803		
93600079	812	94120-93T	572	94616-98	780	94820-02	845	98605AX	803		
93600080	813	94121-93T	572	94624-97B	842	94830-02	569	98605BF	803		
93600081	813	94122-93T	572	94625-98	780	94832-02	569	98606BF	803		
93600082	811	94123-93T	572	94626-98	780	94834-02	569	98606BY	803		
93600083	813	94124-93T	572	94630-98	569	94844-10	815	98606EK	803		
93600084	810	94125-93T	572	94631-98	569	94863-10	837	98625	813		
93600085	812	94126-93T	572	94640-08	821	94868-10	825	98628EK	803		
93600107	815	94127-93T	572	94641-08	821	94869-10	826	98965-99	823		
93600108	810	94130-93T	569	94642-08	821	94871-10	825	99000-77	805		
93600109	810	94131-93T	569	94643-08	821	94873-10	825	99020-90T	705		
93600110	815	94132-93T	569	94645-08	821	94901-03	781	99027-90T	805		
93600113	839	94133-01	613	94647-98	820	94902-03	781	99352-82Z	805		
93600114	815	94135-93T	749	94650-98	824	94923-09	568	99539-97	705		

ONE-YEAR OVER-THE-COUNTER PARTS AND ACCESSORIES WARRANTY

Harley-Davidson warrants that street legal Genuine Motor Parts ("Parts") and street legal Genuine Motor Accessories ("Accessories") that are purchased on or after January 1, 2012 through an authorized dealer will be free from factory defects, under normal use and service, for a period of one year starting from the date of retail sale and delivery (not date of installation). Because this limited warranty covers only Parts and Accessories, labor is not covered. This limited parts warranty does not cover defects or damage due to abuse, misuse or improper installation. This parts warranty applies to Parts and Accessories you or an aftermarket shop have installed, but only for defects in manufacturing — not conditions caused by the improper installation.

This Parts and Accessories warranty is separate and distinct from the limited factory warranty that applies to your stock motorcycle. This Parts and Accessories warranty does not extend or modify the factory warranty that applies to your motorcycle. It only covers the street legal Genuine Motor Parts and street legal Genuine Motor Accessories added to your motorcycle.

This Parts and Accessories warranty does not cover defects, damage or premature wear to your motorcycle that are caused by the installation or use of Parts and Accessories, even those installed by an authorized dealership. Examples include, but are not limited to performance-enhancing powertrain components or software, exhaust systems, non-approved tires, lowering kits, handlebars, add-ons connected to the factory electrical system, etc.

The fact that Parts or Accessories are labeled or branded Harley-Davidson, or are sold or installed by an authorized dealership, does not necessarily make them appropriate or warranted for the make and model of your motorcycle. The use of Parts and Accessories not designed and tested for your motorcycle may have negative consequences on the performance of your motorcycle and may create conditions not covered by the limited factory warranty.

The remedy for breach of this limited Parts and Accessories warranty is expressly limited to the repair or replacement of any component that proves to be defective, and does not extend or create liability for consequential damages, costs or expenses, including loss of time, inconvenience, or loss of use of the motorcycle. Any implied warranty, including warranty of merchantability or fitness for a particular purpose, is expressly limited to the duration of this limited one-year Parts and Accessories warranty, or to the shortest duration permitted by the laws in your state.

EXCLUDED COMPONENTS:

All Genuine Motor Parts & Accessories will qualify for the one-year over-the-counter warranty, with the following exceptions:

- Tires
- Chemicals
- Premium Luggage (two years)
- Audio and Navigation (two years where applicable)
- Non-street legal components (including Screamin' Eagle® Pro)
- Anything with a manufacturer/factory warranty
- Other disposable and consumable items

To obtain warranty service, return the affected component(s) with proof of purchase, at your expense, within the limited warranty period to an authorized Harley-Davidson® dealer.



Harley-Davidson Parts and Accessories Division, a facility of Harley-Davidson Motor Company, is registered to International Quality Standard ISO 9001:2015.

The sale or use of these parts or accessories does not grant the purchaser a license or other right under any Harley-Davidson patent.

IMPORTANT—PLEASE READ: We have tried to make this catalog comprehensive and factual. All product descriptions (including depictions, specifications, dimensions, measurements, ratings and competitive comparisons) are based on available information at the time of publication. Although such descriptions are believed correct, errors and changes can occur and complete accuracy cannot be guaranteed. Harley-Davidson may make changes at any time to prices and specifications, and may change or discontinue any of the items depicted in this catalog, without notice and without incurring any obligation.

ATTENTION: Vehicles in the configurations shown and the accessories described in this catalog may not be available for sale or use in some locations. Please check with your dealer for complete product details and the latest information.

TRADEMARKS: All For Freedom Freedom For All, Aluminator, Badlander, Bar & Shield logo, Blackline, Boom!, Brawler, Breakout, CoolFlow, Cross Bones, Custom Vehicle Operations, CVO, Dark Custom, Daymaker, Destroyer, Deuce, Diamond Back, Diamondback, Digital Technician, Dominion, Dyna, Electra Glide, Electra Glo, Evolution, Fat Bob, Fat Boy, Forty-Eight, Freewheeler, Get-A-Grip, Hard Candy Custom, Harley, Harley-Davidson, Harley-Davidson Street, Harley Owners Group, HD, HDMC, H-D, H-D1, Heritage Softail, Heritage Springer, H.O.G., HOG, Hog Ties, HoldFast, Hugger, Iron883, Knockout, Kahuna, Low Rider, Night Rod, Night Train, Nightster, Profile, Reach, Revolution, Revolution X, Road Glide, Road King, Roadster, Road Tech, Road Zeppelin, Rocker, Screamin' Eagle, Seventy-Two, Signature Series, Softail, Softail Slim, Spectra Glo, Sport Glide, Sportster, Springer, Street, Street Bob, Street Glide, Street Rod, Street Stalker, Sturgis, Sundowner, Sun Ray, Sunwash, Super Glide, SuperLow, SuperLow 1200T, Switchback, SYN3, Tallboy, Tour Glide, Tour-Pak, Tri-Glide, T-Sport, Twin Cam 88, Twin Cam 88B, Twin Cam 96, Twin Cam 96B, Twin Cam 103, Twin Cam 103B, Twin Cam 110, Twin Cam 110B, Twin-Cooled, Ultra Classic, V-Rod, V-Rod Muscle, VRSC, Wide Glide, Willie G, XR1200, XR1200X and the Harley-Davidson Genuine Motor Parts and Genuine Motor Accessories Logo are among the trademarks of H-D U.S.A., LLC.

3M, AGM, Allen, Apple, Bluetooth, Brembo, City Navigator, Cordura, Dow Corning, Dunlop, Galaxy5, Google, Hylomar, iPhone, iPod, Kevlar, Loctite, Michelin, NavTraffic, NavWeather, PJ1, QuickTite, Samsung, Scorcher, Scotchlite, SD, Showa, Sirius, SiriusXM, Teflon, Threadlocker, Velcro, Wounded Warrior Project, Windows, Xenon, XM, zūmo and all other marks are trademarks of their respective owners.



SHOP PARTS & ACCESSORIES: [H-D.COM/SHOP](https://www.harley-davidson.com/shop)

The only way to get Genuine Motor Parts and Accessories is through an authorized Harley-Davidson® dealer or directly from [h-d.com/store](https://www.harley-davidson.com/store). You can ship your online orders to your local participating Harley-Davidson® dealership where you can pick them up — for free. For your nearest local dealership, please visit our dealer locator at [h-d.com/dealer](https://www.harley-davidson.com/dealer).

We care about you. When riding your Harley-Davidson® motorcycle, be sure to ride safely, respectfully and within the limits of the law and your abilities. Always wear an approved helmet, proper eyewear and protective clothing, and insist your passenger does too. Never ride while under the influence of alcohol or drugs. Know your Harley® motorcycle, and read and understand your owner's manual from cover to cover. Sign up for a Harley-Davidson® Riding Academy course (visit [harley-davidson.com/ridingacademy](https://www.harley-davidson.com/ridingacademy) for a course near you) or Motorcycle Safety Foundation rider course (call 1-800-446-9227 for a course near you). Protect your privilege to ride by joining the American Motorcyclist Association. Visit [americanmotorcyclist.com](https://www.americanmotorcyclist.com) for more information.

The sale or use of these parts or accessories does not grant the purchaser a license or other right under any Harley-Davidson patent.

IMPORTANT — PLEASE READ: We have tried to make this catalog comprehensive and factual. All product descriptions (including depictions, specifications, dimensions, measurements, ratings and competitive comparisons) are based on available information at the time of publication. Although such descriptions are believed correct, errors and changes can occur and complete accuracy cannot be guaranteed. Harley-Davidson may make changes at any time to prices and specifications, and may change or discontinue any of the items depicted in this catalog, without notice and without incurring any obligation. **ATTENTION:** Vehicles in the configurations shown and the accessories described in this catalog may not be available for sale or use in some locations. Please check with your dealer for complete product details and the latest information.

Notice: The prices appearing in this catalog are the manufacturer's suggested retail prices. Excludes taxes and shipping. Actual prices may vary.

©2018 H-D or its Affiliates. H-D, Harley, Harley-Davidson and the Bar & Shield Logo are among the trademarks of H-D U.S.A., LLC. Third-party trademarks are the property of their respective owners.
94500259